

Compact AC/DC Autoranging Clamp Multimeter

410002





SPER
SCIENTIFIC

Environmental Measurement

Content	Page
1.Safety.....	4
2.Description.....	6
2-1.Meter Description.....	6
2-2.Symbols Used on LCD Display.....	7
3.Specifications.....	8
3-1.Specifications.....	8
3-2.General Specifications.....	9
4.Operation.....	10
4-1.AC/DC Current Measurement.....	10
4-2.AC/DC Voltage Measurement.....	11
4-3.Resistance Measurement.....	11
4-4.Diode and Continuity Measurement.....	11
4-5.Capacitance Measurement.....	12
4-6.Frequency or % Duty Cycle Measurement.....	12
4-7.Temperature Measurement.....	12
4-8.Non-Contact AC Voltage Measurement.....	13
5.Button.....	13
5-1.MODE Button.....	13
5-2.Data Hold Button.....	13
5-3.REL Button.....	13
6.Battery Replacement.....	13

1. Safety

International Safety Symbols

-  This symbol, adjacent to another symbol or terminal, indicates the user must refer to the manual for further information.
-  This symbol, adjacent to a terminal, indicates that, under normal use, hazardous voltages may be present
-  Double insulation

SAFETY NOTES

- Do not exceed the maximum allowable input range of any function
- Do not apply voltage to meter when resistance function is selected.
- Set the function switch OFF when the meter is not in use.

WARNINGS

- Set function switch to the appropriate position before measuring.
- When measuring volts do not switch to current/resistance modes.
- When changing ranges using the selector switch always disconnect the test leads from the circuit under test.
- Do not exceed the maximum rated input limits.

CAUTIONS

- Improper use of this meter can cause damage, shock, injury or death. Read and understand this user manual before operating the meter.
- Always remove the test leads before replacing the battery.
- Inspect the condition of the test leads and the meter itself for any damage before operating the meter. Repair or replace any damage before use.
- Use great care when making measurements if the voltages are greater than 25VAC rms or 35VDC. These voltages are considered a shock hazard.
- Remove the battery if the meter is to be stored for long periods.
- Always discharge capacitors and remove power from the device under test before performing Diode, Resistance or Continuity tests.
- Voltage checks on electrical outlets can be difficult and misleading because of the uncertainty of connection to the recessed electrical contacts. Other means should be used to ensure that the terminals are not "live".

- If the equipment is used in a manner not specified by the manufacturer, the protection provided by the equipment may be impaired.

Input Limits

Function	Maximum Input
A DC/AC	400A
V DC/AC	600V DC/AC
Frequency, Resistance, Diode, Continuity, Capacitance Test	600V DC/AC
Temperature	600V DC/ AC

2.Description

2-1.Meter Description

- | | |
|--|-------------------------|
| 1-Current Clamp | 7-MODE Select Button |
| 2-Non-Contact AC Voltage Indicator Light | 8-Hz% Hold Button |
| 3-Clamp Trigger | 9-Relative Button |
| 4-Rotary Function Swith | 10-COM Input Jack |
| 5-LCD Display | 11-Positive Input Jacks |
| 6-Data Hold Button | 12-Battery Cover |

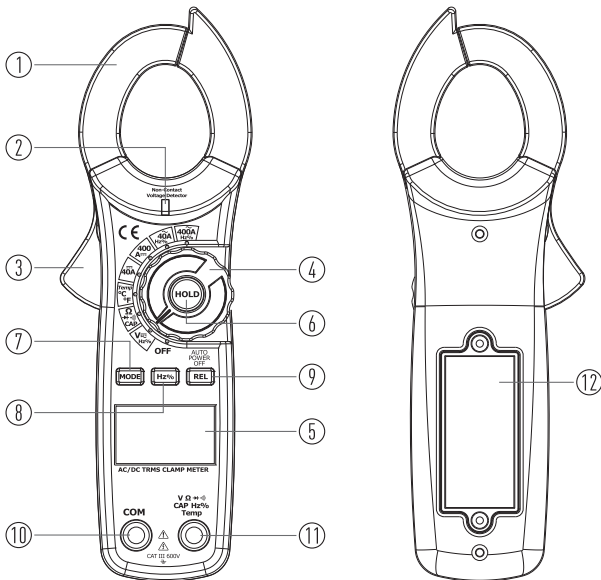

2-2. Symbols Used on LCD Display

- | | |
|----------------------------|---|
| 1-DC (Direct Current) | 9-Frequency Mode |
| 2-AC (Alternating Current) | 10-Duty Cycle Mode |
| 3-Minus Sign | 11-Auto Power Off |
| 4-Auto Range Mode | 12-Units of Measure List |
| 5-Diode Test Mode | 13-Low Battery |
| 6-Audible Continuity | 14-Celsius Units |
| 7-Data Hold Mode | 15-Fahrenheit Units |
| 8-Relative Mode | 16-4000 Count (0 to 3999) Measurement Reading |

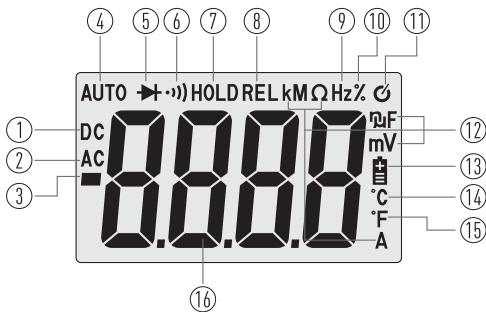

3. Specifications

3-1. Specifications

Function	Range & Resolution	Accuracy \pm (% of reading)
AC Current (50/60Hz)	40.00A	\pm (2.5% + 8 digits)
	400.0A	\pm (2.8% + 5 digits)

All AC Current ranges are specified from 5% of range to 100% of range.

DC Current	40.00A	\pm (2.5% + 5 digits)
	400.0A	\pm (2.8% + 5 digits)

AC Voltage (50-400Hz)	4.000V	\pm (1.5% + 5 digits)
	40.00V	
	400.0V	\pm (2.0% + 5 digits)
	600V	

All AC voltage ranges are specified from 5% of range to 100% of range.

AC Voltage bandwidth: 50 to 400Hz (Sine); 50 to 60Hz (All wave).

DC Voltage	400.0mV	\pm (0.8% + 2 digits)
	4.000V	\pm (1.5% + 2 digits)
	40.00V	
	400.0V	
	600V	\pm (2% + 2 digits)

Resistance	400.0 Ω	\pm (1.0% + 4 digits)
	4.000K Ω	\pm (1.5% + 2 digits)
	40.00K Ω	
	400.0K Ω	
	4.000M Ω	\pm (2.5% + 3 digits)
	40.00M Ω	\pm (3.5% + 5 digits)

Capacitance	40.00nF	\pm (4.0% + 20 digits)
	400.0nF	\pm (3% + 5 digits)
	4.000 μ F	
	40.00 μ F	\pm (4.0% + 10 digits)
	400.0 μ F	
	4.000mF	\pm (5.0% + 10 digits)

Function	Range & Resolution	Accuracy \pm (% of reading)
Frequency	10-10kHz	$\pm(1.2\% + 2 \text{ digits})$
Sensitivity: 15Vrms		
Duty Cycle	0.5% to 99.0%	$\pm(1.2\% + 2 \text{ digits})$
Pulse width: 100 μ s to 100ms, Frequency: 10Hz to 10kHz.		
Temp	-20 to 760°C	$\pm(3\% + 5^\circ\text{C})$
(Type-K)	-4 to 1400°F	$\pm(3\% + 9^\circ\text{F})$
Probe accuracy not included.		

3-2. General Specifications

Clamp Size	Opening 1.2" (30mm) Approx
Diode Test	Test current of 0.3mA typical; Open circuit voltage 3V DC typical.
Continuity Check	Threshold <50 Ω ; Test current <0.5mA
Low Battery Indication	"  " is displayed
Overrange Indication	"OL" is displayed
Measurements Rate	2 per second, nominal
Input Impedance	10M Ω (VDC and VAC)
Display	4000 counts LCD
AC Current	50-60Hz (AAC)
AC Response	TRUE RMS
AC Voltage Bandwidth	50-400Hz (VAC)
Operating Temperature	5 to 40°C (41 to 104°F)
Storage Temperature	-20 to 60°C (-4 to 140°F)
Operating Humidity	Max 80% up to 31°C (87°F) decreasing, Linearly to 50% at 40°C (104°F)
Storage Humidity	<80%
Operating Altitude	7000ft. (2000meters) maximum.
Over Voltage	Category III 600V
Battery	Two "AAA" 1.5V Batteries
Auto Off	Approx. 30 minutes
Safety	For indoor use and in accordance with Overvoltage Category II, Pollution Degree 2. Category II includes local level, appliance, portable equipment, etc., with transient overvoltages less than Overvoltage Cat. III

4. Operation

NOTICES: Read and understand all warning and precaution statements listed in the safety section of this operation manual prior to using this meter. Set the function select switch to the OFF position when the meter is not in use.

4-1.AC/DC Current Measurement

WARNING: Ensure that the test leads are disconnected from the meter before making current clamp measurements.

1. Set the Function switch to the **400ADC**, **40ADC**, **400AAC** or **40AAC** range.
2. If the range of the measured is not known, select the higher range first then move to the lower range if necessary.
3. Press the trigger to open jaw, Fully enclose one conductor to be measured.
4. The clamp meter LCD will display the reading.

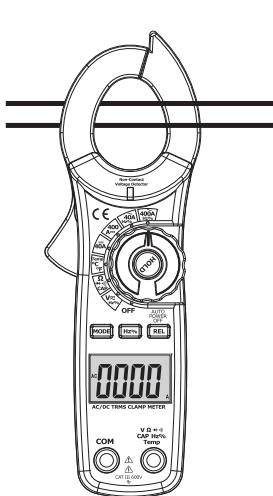

NO

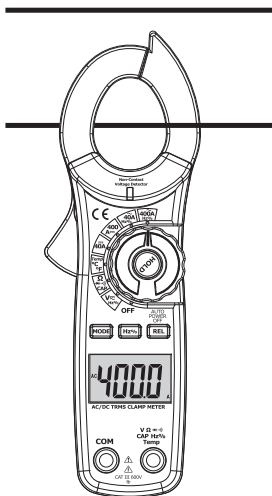

YES

4-2.AC/DC Voltage Measurement

- 1.Insert the black test lead into the negative **COM** terminal and the red test lead into the **Positive** terminal.
- 2.Set the function switch to the **V AC/DC** position.
- 3.Select **AC** or **DC** with the **MODE** Button.
- 4.Connect the test leads in parallel to the circuit under test.
- 5.Read the voltage measurement on the LCD display.

4-3.Resistance Measurement

- 1.Insert the black test lead into the negative **COM** terminal and the red test lead into the **Positive** terminal.
- 2.Set the function switch to the Ω \rightarrow \rightarrow \rightarrow CAP position.
- 3.Touch the test probe tips across the circuit or component under test, It is best to disconnect one side of the device under test so the rest of the circuit will not interfere with the resistance reading.
- 4.For Resistance tests, read the resistance on the LCD display.

4-4.Diode and Continuity Measurement

- 1.Insert the black test lead banana plug into the negative **COM** jack and the red test lead banana plug into the **Positive** jack.
- 2.Turn the rotary switch to the Ω \rightarrow \rightarrow \rightarrow CAP position.
- 3.Press the MODE button until " \rightarrow " appears in the display.
- 4.Touch the test probes to the diode under test, Forward voltage will indicate 0.4V to 0.7V. Reverse voltage will indicate "OL". Shorted devices will indicate near 0mV and an open device will indicate "OL" in both polarities.



- 5.For Continuity tests, if the resistance is $< 50 \Omega$, a tone will sound.

4-5. Capacitance Measurement

WARNING: To avoid electric shock, disconnect power to the unit under test and discharge all capacitors before taking any capacitance measurements. Remove the batteries and unplug the line cords.

1. Set the rotary function switch to the $\Omega \rightarrow \rightarrow \rightarrow \text{CAP}$ position.
2. Insert the black test lead banana plug into the negative **COM** Jack, Insert the red test lead banana plug into the **Positive** Jack.
3. Touch the test leads to the capacitor to be tested.
4. Read the capacitance value in the display

4-6. Frequency or % Duty Cycle Measurement

1. Set the rotary function switch to the **VDC/AC Hz%** Position.
2. Insert the black lead banana plug into the negative **COM** Jack and the red test lead banana plug into the **Positive** Jack.
3. Select **Hz** or **% Duty** with the **Hz/%** Button.
4. Touch the test probe tips to the circuit under test.
5. Read the frequency on the display.

4-7. Temperature Measurement

WARNING: To avoid electric shock, disconnect both test probes from any source of voltage before making a temperature measurement.

1. Set the function switch to **TEMP.** Position.
2. Insert the temperature probe into the negative **COM** and the **Positive** Jacks, making sure to observe the correct polarity.
3. Touch the temperature probe head to the part whose temperature you wish to measure. Keep the probe touching the part under test until the reading stabilizes (about 30 seconds).
4. Read the temperature in the display. The digital reading will indicate the proper decimal point and value.

WARNING: To avoid electric shock, be sure the thermocouple has been removed before changing to another measurement function.

4-8. Non-Contact AC Voltage Measurement

1. Touch the probe tip to the hot conductor or insert into the hot side of the electrical outlet.
2. If AC voltage is present, the detector light will illuminate.

NOTE: The conductors in electrical cord sets are often twisted. For best results, rub the probe tip along a length of the cord to assure placing the tip in close proximity to the live conductor.

NOTE: The detector is designed with high sensitivity. Static electricity or other sources of energy may randomly trip the sensor. This is normal operation.

5. Button

5-1. MODE Button

To select DC/ACV, OHM/Diode/Continuity/CAP.

5-2. Data Hold Button

- To freeze the LCD meter reading, press the data hold button.
- The data hold button is located on the left side of the meter (Top button).
- While data hold is active, the HOLD display icon appears on the LCD.
- Press the data hold button again to return to normal operation.

5-3. REL Button

For DCA and Capacitance Zero & Offset adjustment.

6. Battery Replacement

- Remove the one rear Phillips head screw.
- Open the battery compartment.
- Replace the Requires Two "AAA" 1.5V Battery (UM4 R03).
- Re-assemble the meter.

WARRANTY

Sper Scientific warrants this product against defects in materials and workmanship for a period of **one (1) year** from the date of purchase, and agrees to repair or replace any defective unit without charge. If your model has since been discontinued, an equivalent Sper Scientific product will be substituted if available. This warranty does not cover probes, batteries, battery leakage, or damage resulting from accident, tampering, misuse, or abuse of the product. Opening the meter to expose its electronics will break the waterproof seal and void the warranty.

To obtain warranty service, ship the unit postage prepaid to:

SPER SCIENTIFIC LTD.

8281 East Evans Road, Suite #103
Scottsdale, AZ 85260

The defective unit must be accompanied by a
 and your return address.
at www.sperwarranty.com

