

PZ-200



■ FEATURES

- The compact design saves the space
- By VR, any pressure unit can be set to full scale
- With pressure switch function (4 points setting)
- Meets DIN sizes (72 × 72 mm)
- Input signal: 1 ~ 5 V or 4 ~ 20 mA

■ COMPATIBILITY WITH SENSORS

PZ-200 shall be used with Copal's pressure transducers with Amp. and other sensors whose output signals are DC1~5 V or 4~20 mA.

■ MODEL NUMBER DESIGNATION

P Z - 2 0 0

Series name

PZ-200

PRESSURE INDICATORS

STANDARD SPECIFICATIONS

● Unless otherwise specified, the specs are defined at an ambient temperature of 25 ± 5 °C and excitation voltage of 12 V DC.

Item		Model number	PZ-200	
General specifications	Operating temp. range	°C	0 ~ 50	
	Compensated temp. range	°C	0 ~ 50	
	Operating humidity	%RH	35 ~ 85 (No condensation)	
	Storage temp.	°C	- 20 ~ 70 (Atmospheric pressure, humidity 65 %RH maximum)	
	Net weight	g	Approx. 150	
	Power		Power : 12 ~ 24 V DC \pm 10 % Consumption current : 0 mA maximum	
Input	Input signal		1 ~ 5 V/4 ~ 20 mA (Internal switch provided)	
	Input impedance	k Ω	120 (1 ~ 5 V Input setting)	
	Internal resistance	Ω	51 (4 ~ 20 mA Input setting)	
	Maximum input voltage	V	30	
	Maximum input current	mA	70	
Display	No. of digits		3 1/2	
	Display element		LCD	
	Rated display range		0 ~ 1000	
	Display cycle		Approx. 4 times/s	
	Display accuracy		\pm 0.1 % Reading \pm 2 counts (After calibration)	
	Thermal error	Zero point indication		\pm 3 counts/10 °C
		Full scale indication		\pm 3 counts/10 °C
	Resolution		1 count	
	Zero point variable range		\pm 200 counts	
	Full scale variable range		\pm 200 ~ 1000 counts	
	Decimal point location		10 ² 、10 ¹ 、10 ⁰ (Selected by a panel switch)	
	Polarity change		Negative “-” indication (actuated by panel switch)	
Over-range indication		“ 1 * * * ” when the number exceeds \pm 1999 (* : OFF)		
Switch	Pressure setting range		0 ~ 1000	
	Number of setting points		① (LL)、② (L)、③ (H)、④ (HH)	
	Switching capacity		30 V DC、100 mA (NPN open collector)	
	Residual voltage		1.2 V DC (at 100 mA of inflow current)	
	Output status		3 modes (Refer to pressure switch output function)	
	Setting method		By setting VR	
	Response		Approx. 100 ms	
Analog output			Current output: 4 ~ 20 mA, Accuracy: \pm 0.5 %F.S. (at 25 ± 5 °C), Load: 250 Ω maximum	

PZ-200

PRESSURE INDICATORS

ENVIRONMENTAL CHARACTERISTICS

Test item	Test conditions	Permissible change
Vibration	Amplitude 1.5 mm P-P, 10 ~ 55 Hz, 3 directions for 2 hours each (packed)	Pressure indication, switch setting and analog output variation: $\pm 1\%$ F.S., maximum each.
Shock	98.1 m/s ² , 3 directions for 3 times each (packed)	
Moisture resistance	40 °C, 90 ~ 95 %RH, 240 hrs.	

OUTLINE DIMENSION

Unless otherwise specified, tolerance: ± 0.5 (Unit: mm)

PZ-200

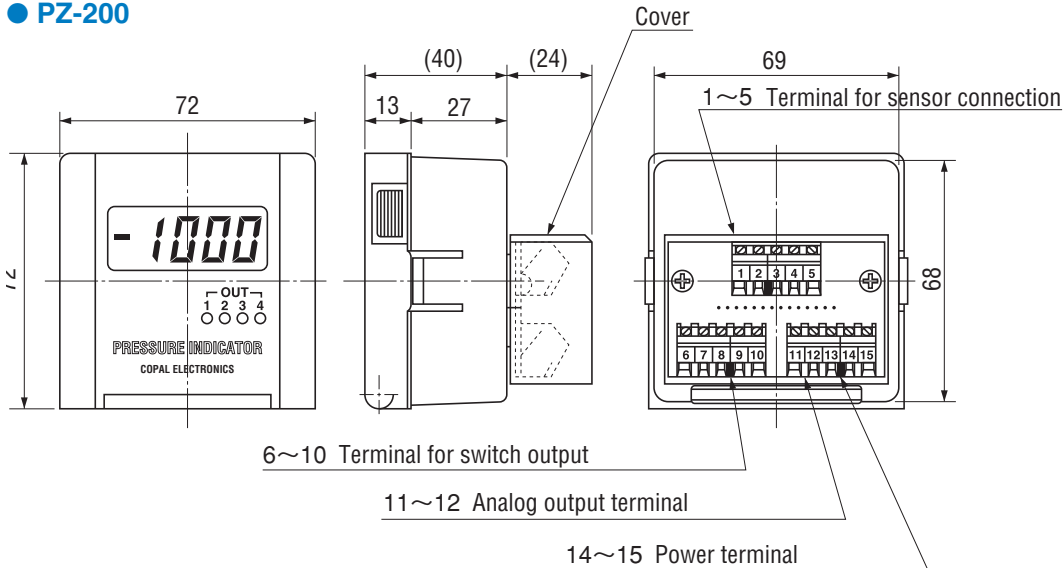

No.	Connection
1	Sensor signal IN (1 ~5 V)
2	Sensor signal IN (4 ~20 mA)
3	Sensor power out (+)
4	Sensor power out (Common)
5	Common
6	LL OUT
7	L OUT
8	H OUT
9	HH OUT
10	Switch out (Common)
11	Analog output (4 ~ 20 mA)
12	Analog output (Common)
13	Common
14	Power IN (+) (DC12 ~ 24 V)
15	Power IN (Common)

※ Please refer to the page of PG-200 series for panel cut dimension.

※ All the "Common" connections are made inside.

INSIDE OF A PANEL

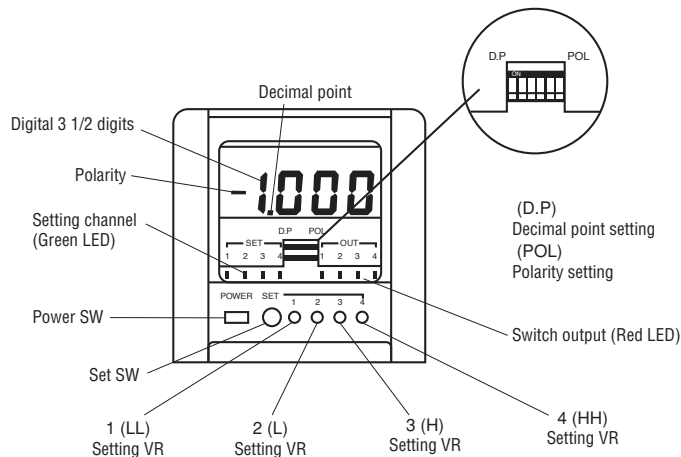

CONNECTION OF PRESSURE SENSOR

● Example) 1 ~ 5 V output sensor

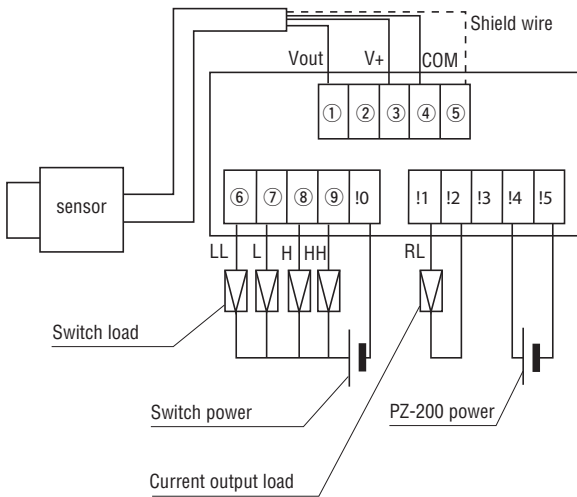

● Example) 4 ~ 20 mA output sensor

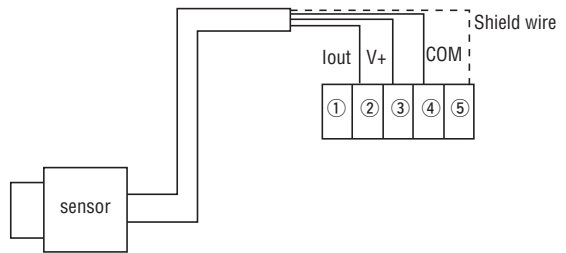

● Example) 4 ~ 20 mA output sensor

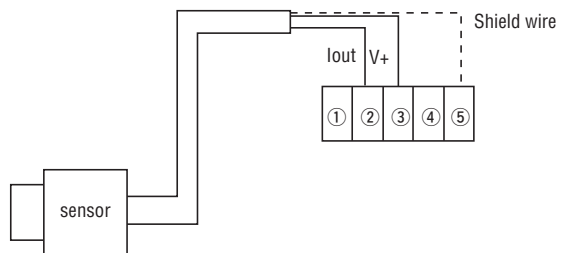

※ Shield should not be earthed when sensor is earthed.

(PZ-200) SWITCH OUTPUT SCHEMATICS

a) Upper limit mode

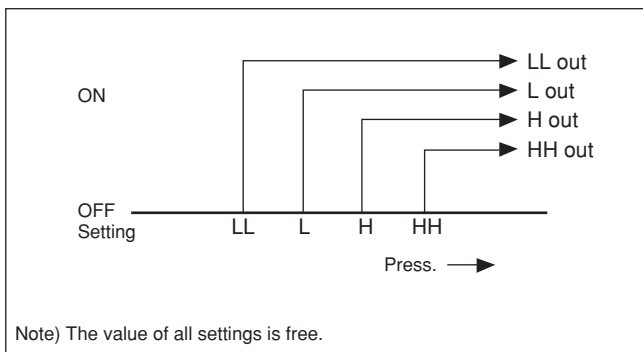

b) Window mode

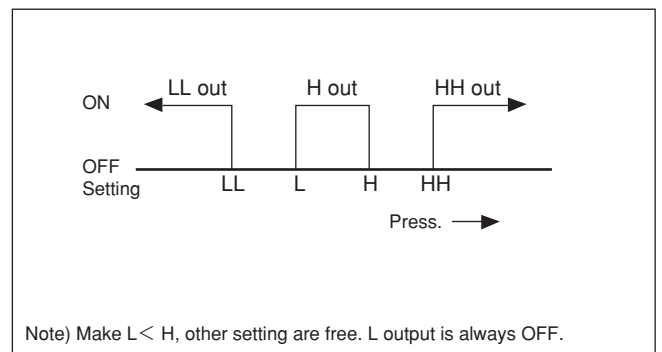

c) Upper and lower limit mode

