

Features

- On Chip Hall Sensor
- Rotor-Locked Shutdown
- Automatically Restart
- Built-in Zener Protection for Output Driver
- Operating Voltage: 3.8V~28V
- Output Current: $I_{O(AVE)} = 400mA$
- Lead Free Packages: SIP-4L and SOT89-5L (Note 1)
- SIP-4L and SOT89-5L: Available in "Green" Molding Compound (No Br, Sb)
- Lead Free Finish/ RoHS Compliant (Note 2)
- **For automotive applications requiring specific change control (i.e. parts qualified to AEC-Q100/101/200, PPAP capable, and manufactured in IATF 16949 certified facilities), please [contact us](#) or your local Diodes representative.**
<https://www.diodes.com/quality/product-definitions/>

General Description

AH287 is a monolithic fan motor controller with Hall sensor's capability. It contains two complementary open-drain drivers for motor's coil driving, automatic lock shutdown and restart function relatively.

Rotor-lock shutdown detection circuit turns off the output driver when the rotor is blocked to avoid coil overheat. Then, the automatic recovery circuit will restart the motor. These protected actions are repeated and periodic during the blocked period. Until the blocking is removed, the motor recovers and runs normally.

Typical Application Circuit

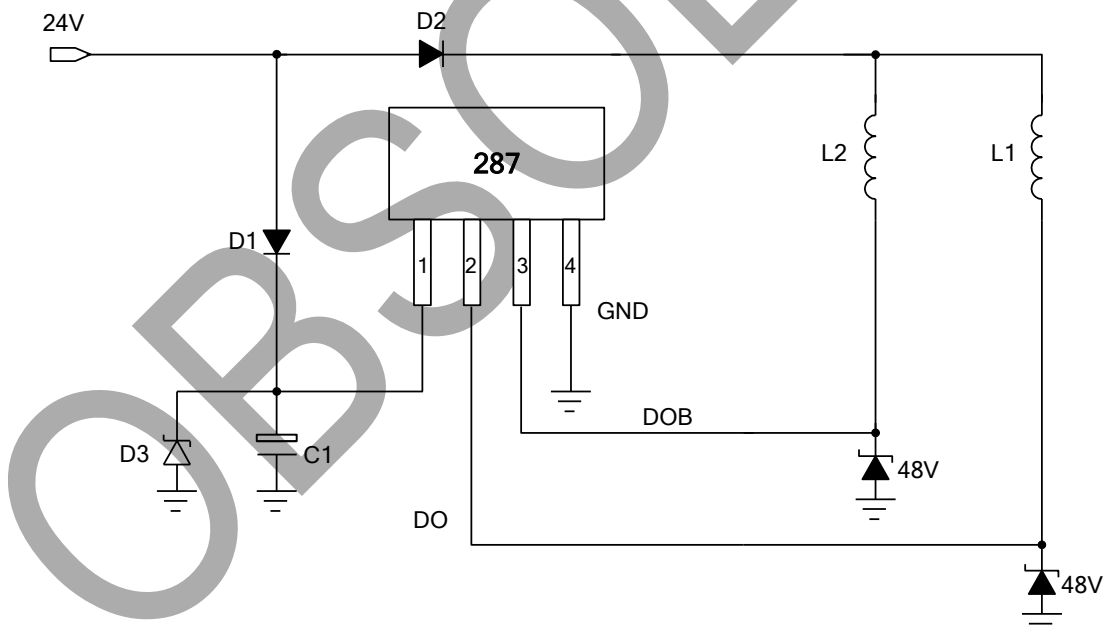

Note: The optional Capacitor C1 and Diode D3 are for power stabilization. C1 is recommended to be E-Cap., $\mu F/25V$; D3 is recommended to be Zener Diode, $V_z = 27V$. Which C1 and D3 value need to be fine tuned to optimize design for different coils and power suppliers.

24V Brush-Less DC Fan

OBSOLETE - PART DISCONTINUED

Ordering Information

AH 287 - X X - X

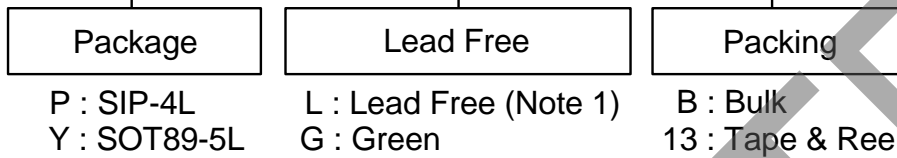

Device	Package Code	Packaging (Note 3)	Bulk		13" Tape and Reel	
			Quantity	Part Number Suffix	Quantity	Part Number Suffix
AH287-PL-B	P	SIP-4L	1000	-B	NA	NA
AH287-PG-B	P	SIP-4L	1000	-B	NA	NA
AH287-YL-13	Y	SOT89-5L	NA	NA	2500/Tape & Reel	-13
AH287-YG-13	Y	SOT89-5L	NA	NA	2500/Tape & Reel	-13

- Notes:
- AH287-YL-13 will be replaced by AH287-YG-13
 - EU Directive 2002/95/EC (RoHS). All applicable RoHS exemptions applied. Please visit our website at http://www.diodes.com/products/lead_free.html.
 - Pad layout as shown on Diodes Inc. suggested pad layout document AP02001, which can be found on our website at <http://www.diodes.com/datasheets/ap02001.pdf>.
 - Reverse taping as shown on Diodes Inc. Surface Mount (SMD) Packaging document AP02007, which can be found on our website <http://www.diodes.com/datasheets/ap02007.pdf>.

Pin Assignment

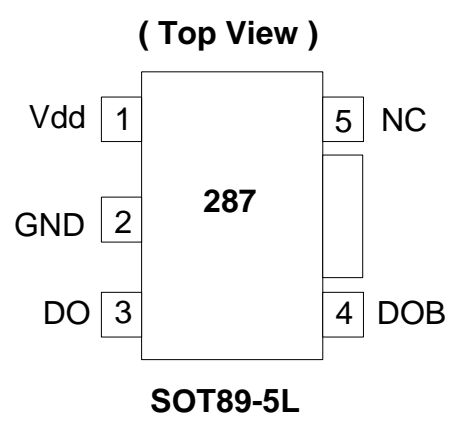
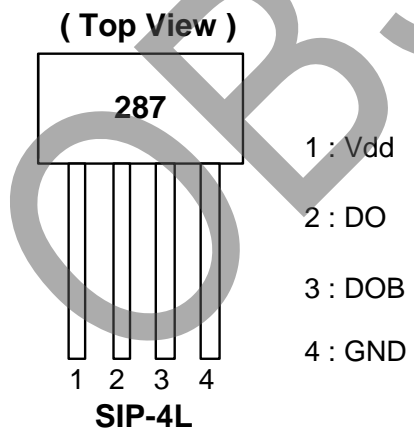

Pin Descriptions

Pin Name	Description
Vdd	Input Power
DO	Output Pin
DOB	Output Pin
GND	Ground
NC	Not Connected

Block Diagram

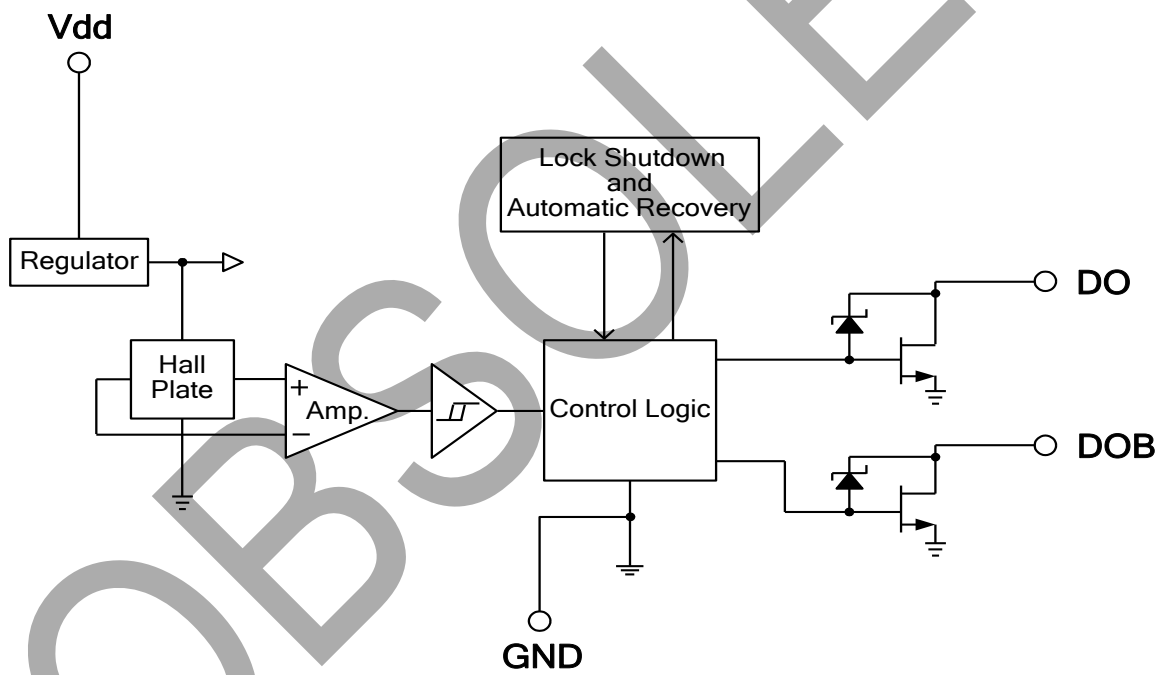

Absolute Maximum Ratings ($T_A = 25^{\circ}\text{C}$)

Symbol	Characteristics		Rating	Unit	
V _{dd}	Supply Voltage		30	V	
I _o	Output Current	I _{O(AVE)}	SIP-4L	400	mA
			SOT89-5L	400	mA
		I _{O(PEAK)}	700	mA	
P _D	Power Dissipation	SIP-4L	550	mW	
		SOT89-5L	800	mW	
T _{ST}	Storage Temperature		-55 ~ 150	°C	
T _J	Maximum Junction Temperature		150	°C	
θ _{JA}	Thermal Resistance Junction-to-Case (Note 5)	SIP-4L	227	°C/W	
		SOT89-5L	156	°C/W	

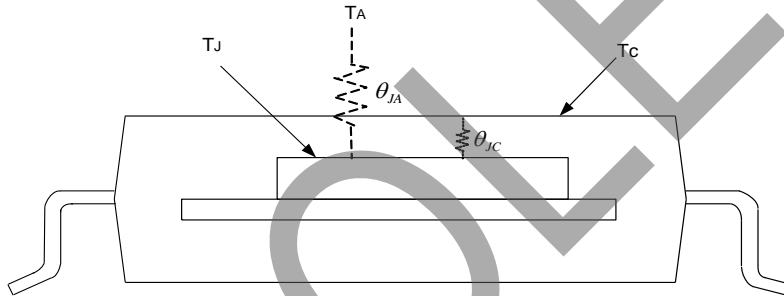

Notes: 5. θ_{JA} should be confirmed with what heat sink thermal resistance. If no heat sink contacting, θ_{JA} is almost the same as θ_{JC}.

Recommended Operating Conditions

Symbol	Characteristic	Conditions	Min	Max	Unit
V _{dd}	Supply Voltage (Note 6)	Operating	3.8	28	V
T _A	Operating Ambient Temperature	Operating	-40	100	°C

Notes: 6. Please watch out the current limit issue when the operation voltage is over 26.4V, because of the different efficiency in the coil.

Electrical Characteristics (T_A = 25 °C, V_{dd} = 24V, unless otherwise specified)

Symbol	Characteristics	Conditions	Min	Typ.	Max	Unit
I _{dd}	Supply Current	Operating	-	2.0	4.0	mA
I _{OFF}	Output Leakage Current	V _{OUT} =24V	-	< 0.1	10	μA
T _{LRP-ON}	Locked Protection On		0.4	0.46	0.6	Sec
T _{LRP-OFF}	Locked Protection Off		2.4	2.76	3.6	Sec
V _{OUT(SAT)}	Output Saturation Voltage	I _O =200mA	-	450	700	mV
		I _O =300mA	-	680	800	mV
R _{DS(ON)}	Output On Resistance	I _O =200mA	-	2.25	3.5	ohm
V _Z	Output Zener-Breakdown Voltage		42	55	65	V

Truth Table

IN-	IN+	CT	OUT1	OUT2	Mode
H	L	L	H	L	Rotating
L	H	L	L	H	Rotating
-	-	H	off	off	Lockup protection activated

Magnetic Characteristics (T_A = 25 °C, V_{dd} = 24V, unless otherwise specified, Note 7)

(1mT=10 Gauss)

Symbol	Characteristics	Min	Typ.	Max	Unit
B _{op}	Operate Point	10	30	60	Gauss
B _{rp}	Release Point	-60	-30	-10	Gauss
B _{hy}	Hysteresis	--	60	--	Gauss

Notes: 7. Magnetic characteristics are for design information, which will vary with supply voltage, operating temperature and after soldering.

Operating Characteristics

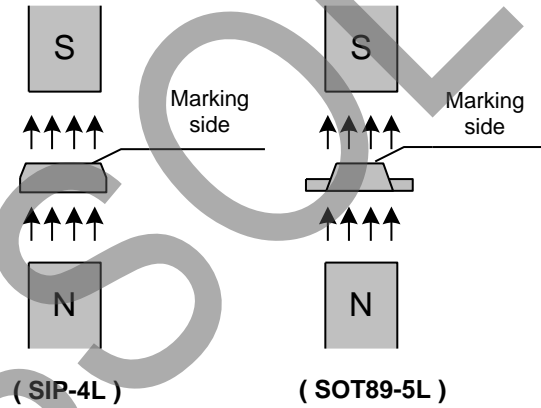
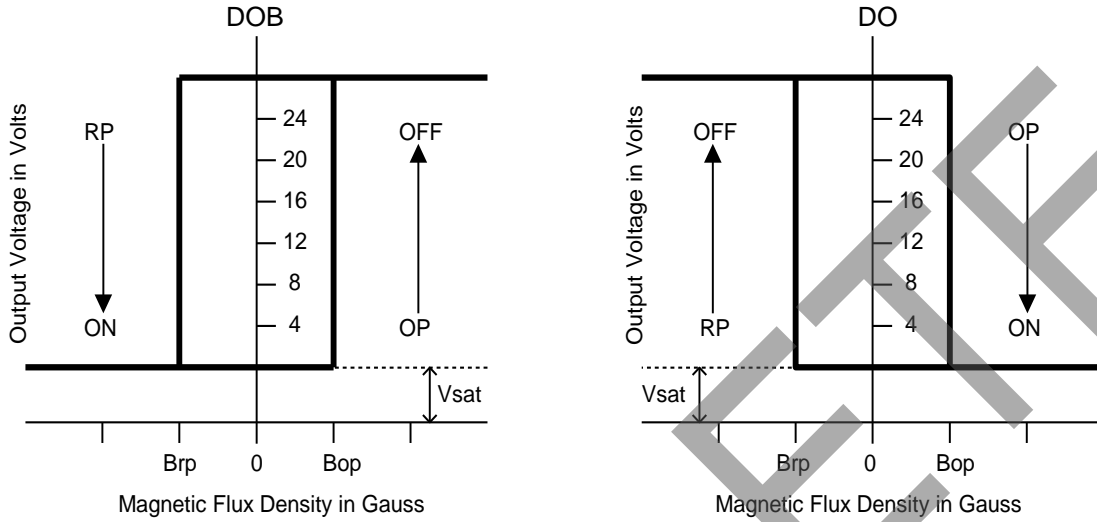

OBSOLETE - PART DISCONTINUED

Performance Characteristics

(1) SIP-4L

T_A (°C)	25	50	60	70	80	85	90	95	100
P _D (mW)	550	440	396	352	308	286	264	242	220
T_A (°C)	105	110	115	120	125	130	135	140	150
P _D (mW)	198	176	154	132	110	88	66	44	0

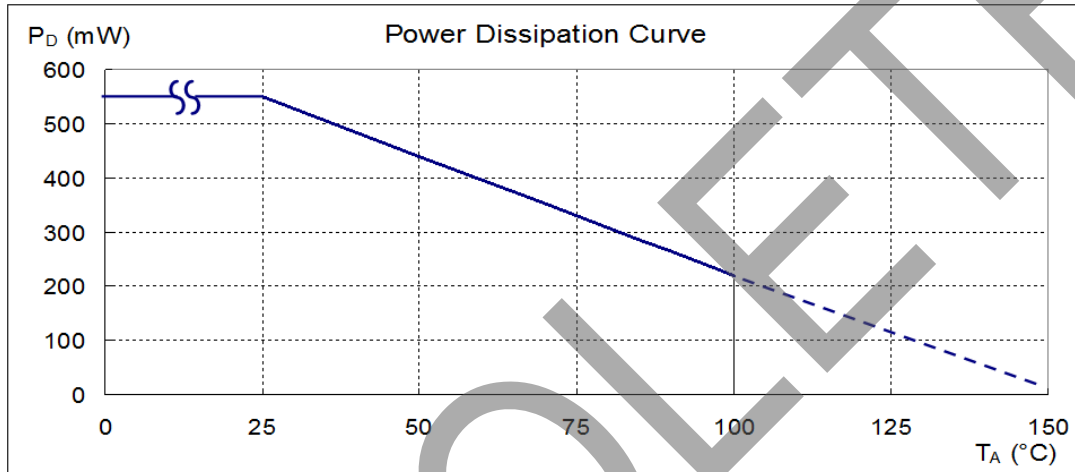

(2) SOT89-5L

T_A (°C)	25	50	60	70	75	80	85	90	95	100
P _D (mW)	800	640	576	512	480	448	416	384	352	320
T_A (°C)	105	110	115	120	125	130	135	140	145	150
P _D (mW)	288	256	224	192	160	128	96	64	32	0

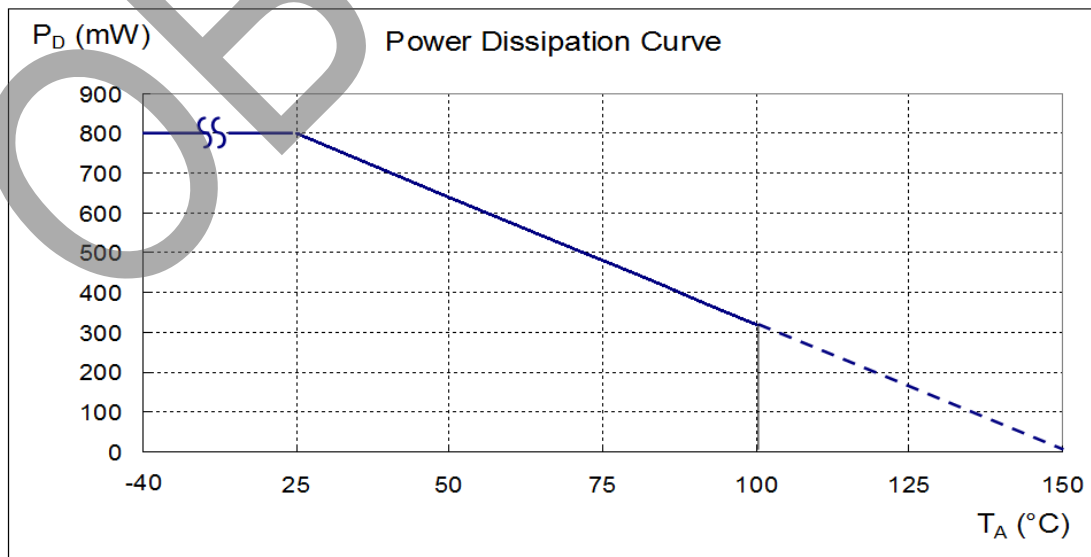

Marking Information

(1) SIP-4L

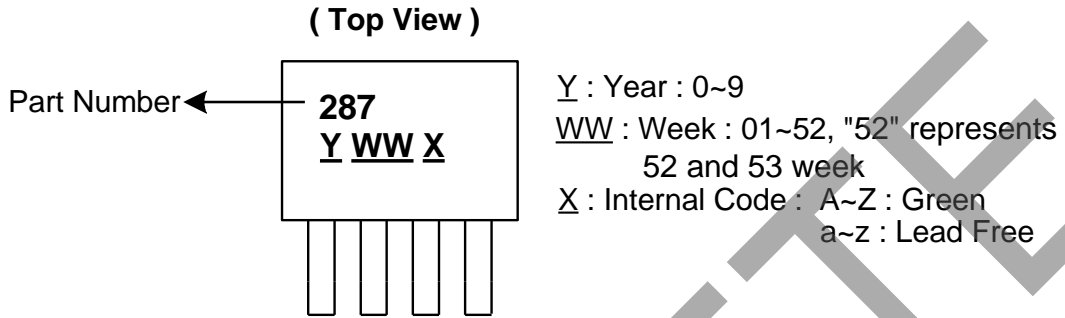

(2) SOT89-5L

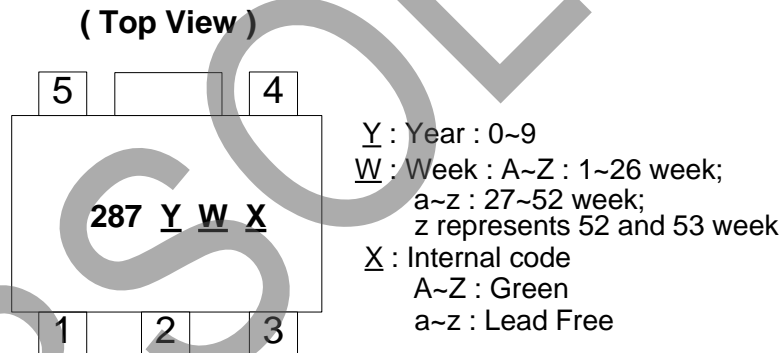

OBSOLETE - PART DISCONTINUED

OBSOLETE

Package Information (All Dimensions in mm)

(1) Package type: SIP-4L

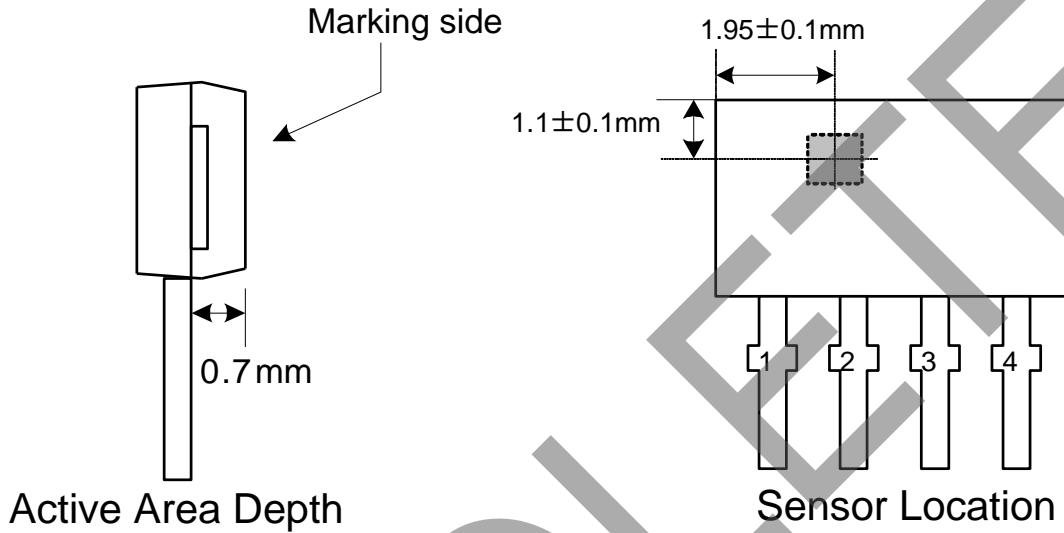

Package Dimension

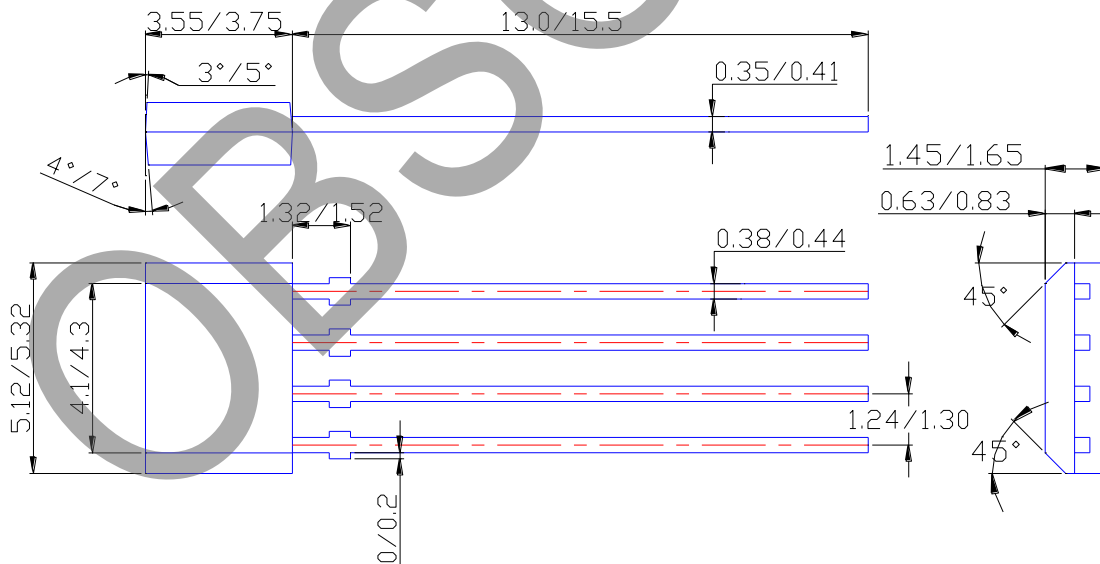

OBSOLETE - PART DISCONTINUED

Package Information (Continued)

(2) Package type: SOT89-5L

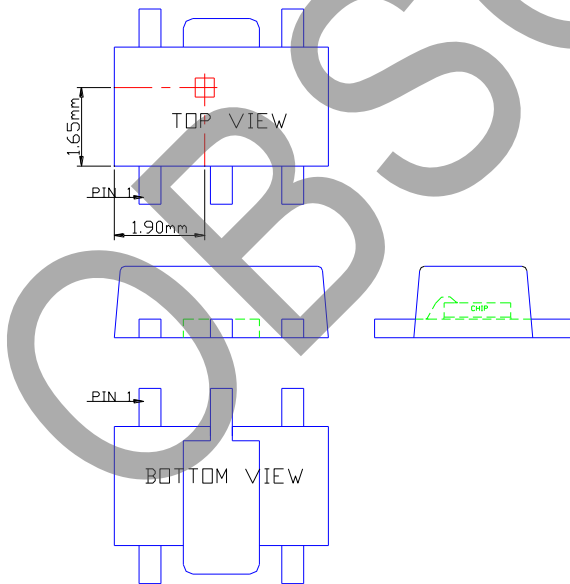
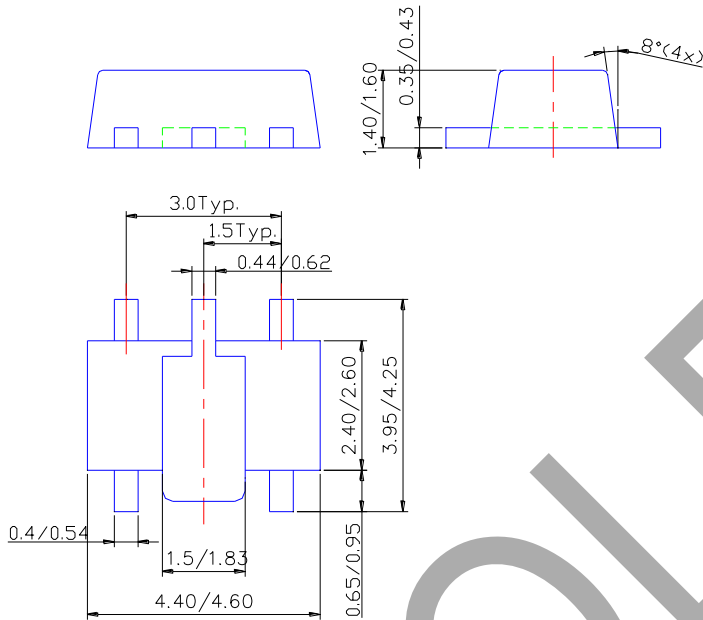

Sensor Location

OBSOLETE - PART DISCONTINUED

IMPORTANT NOTICE

DIODES INCORPORATED MAKES NO WARRANTY OF ANY KIND, EXPRESS OR IMPLIED, WITH REGARDS TO THIS DOCUMENT, INCLUDING, BUT NOT LIMITED TO, THE IMPLIED WARRANTIES OF MERCHANTABILITY AND FITNESS FOR A PARTICULAR PURPOSE (AND THEIR EQUIVALENTS UNDER THE LAWS OF ANY JURISDICTION).

Diodes Incorporated and its subsidiaries reserve the right to make modifications, enhancements, improvements, corrections or other changes without further notice to this document and any product described herein. Diodes Incorporated does not assume any liability arising out of the application or use of this document or any product described herein; neither does Diodes Incorporated convey any license under its patent or trademark rights, nor the rights of others. Any Customer or user of this document or products described herein in such applications shall assume all risks of such use and will agree to hold Diodes Incorporated and all the companies whose products are represented on Diodes Incorporated website, harmless against all damages.

Diodes Incorporated does not warrant or accept any liability whatsoever in respect of any products purchased through unauthorized sales channel. Should Customers purchase or use Diodes Incorporated products for any unintended or unauthorized application, Customers shall indemnify and hold Diodes Incorporated and its representatives harmless against all claims, damages, expenses, and attorney fees arising out of, directly or indirectly, any claim of personal injury or death associated with such unintended or unauthorized application.

Products described herein may be covered by one or more United States, international or foreign patents pending. Product names and markings noted herein may also be covered by one or more United States, international or foreign trademarks.

This document is written in English but may be translated into multiple languages for reference. Only the English version of this document is the final and determinative format released by Diodes Incorporated.

LIFE SUPPORT

Diodes Incorporated products are specifically not authorized for use as critical components in life support devices or systems without the express written approval of the Chief Executive Officer of Diodes Incorporated. As used herein:

A. Life support devices or systems are devices or systems which:

1. are intended to implant into the body, or
2. support or sustain life and whose failure to perform when properly used in accordance with instructions for use provided in the labeling can be reasonably expected to result in significant injury to the user.

B. A critical component is any component in a life support device or system whose failure to perform can be reasonably expected to cause the failure of the life support device or to affect its safety or effectiveness.

Customers represent that they have all necessary expertise in the safety and regulatory ramifications of their life support devices or systems, and acknowledge and agree that they are solely responsible for all legal, regulatory and safety-related requirements concerning their products and any use of Diodes Incorporated products in such safety-critical, life support devices or systems, notwithstanding any devices- or systems-related information or support that may be provided by Diodes Incorporated. Further, Customers must fully indemnify Diodes Incorporated and its representatives against any damages arising out of the use of Diodes Incorporated products in such safety-critical, life support devices or systems.

Copyright © 2020, Diodes Incorporated

www.diodes.com