

Evaluating the AD7386 4-Channel 16-Bit, Dual Simultaneous Sampling, SAR ADC

FEATURES

- ▶ Full featured evaluation board multichannel, simultaneous sampling ADC
- ▶ On-board reference, reference buffer, and ADC driver
- ▶ On-board power supplies
- ▶ Board-compatible high speed system demonstration platform (EVAL-SDP-CH1Z (SDP-H1)) controller
- ▶ PC software for control and data analysis

EVALUATION KIT CONTENTS

- ▶ EVAL-AD7386FMCZ evaluation board
- ▶ Instructions to download software

ADDITIONAL EQUIPMENT NEEDED

- ▶ EVAL-SDP-CH1Z
- ▶ Signal source
- ▶ PC running Windows XP SP3, Windows Vista, Windows 7, or Windows 10 with a USB port

ONLINE RESOURCES

- ▶ [AD7386 data sheet](#)
- ▶ [ACE evaluation software](#)
- ▶ [AD738x ACE plugin](#)

EVALUATION BOARD CONNECTION DIAGRAM

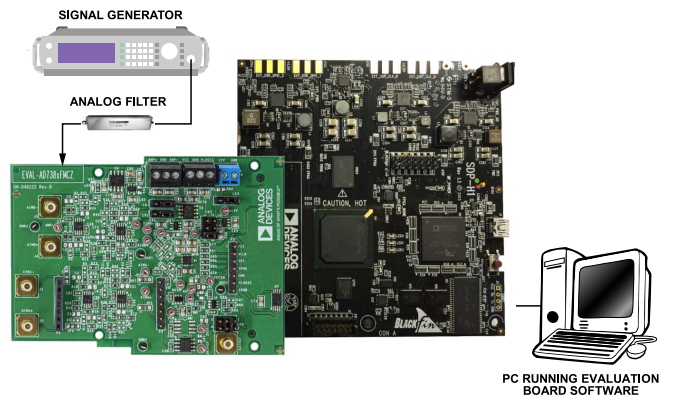

Figure 1. Typical Setup of the EVAL-AD7386FMCZ (Left) and the EVAL-SDP-CH1Z (Right)

GENERAL DESCRIPTION

The EVAL-AD7386FMCZ is a full featured evaluation board designed to evaluate all the features of the [AD7386](#) analog-to-digital converter (ADC). The evaluation board can be controlled by the [EVAL-SDP-CH1Z](#) via the 160-way system demonstration platform connector, P7. The [EVAL-SDP-CH1Z](#) board controls the evaluation board through the USB port of the PC using the Analysis Control Evaluation (ACE) software, which is available for download from the [ACE](#) software page.

The EVAL-AD7386FMCZ can evaluate the [AD7387](#), [AD7388](#), [AD4684](#), and [AD4685](#) by using the [AD738x ACE plugin](#) found on the EVAL-AD7386FMCZ product page. The only difference is the number of SCLKs that clock out the conversion results, which is dependent on the resolution and throughput rate for each generic.

Complete specifications for the [AD7386](#), [AD7387](#), [AD7388](#), [AD4684](#), and [AD4685](#) are provided in the [AD7386/AD7387/AD7388](#) and [AD4684/AD4685](#) data sheets. Consult these specifications in conjunction with this user guide when using the evaluation board. Full details on the [EVAL-SDP-CH1Z](#) are available on the [SDP-H1](#) product page. The comprehensive ACE user guide is available on the [ACE](#) software page.

Figure 1 shows the typical setup of the EVAL-AD7386FMCZ.

TABLE OF CONTENTS

Features.....	1	Evaluation Board Setup Procedures.....	8
Evaluation Kit Contents.....	1	Evaluation Software Operation.....	10
Additional Equipment Needed.....	1	Launching the Software.....	10
Online Resources.....	1	Description of Chip View.....	10
General Description.....	1	Description of Chip View Window.....	11
Evaluation Board Connection Diagram.....	1	Channel Selection.....	11
Quick Start Guide.....	3	Oversampling.....	12
Evaluation Board Hardware.....	4	Reference.....	12
AD7386 Description	4	Serial Mode.....	12
Power Supplies.....	4	Description of Memory Map Window.....	12
Link Configuration Options.....	5	Description of Analysis Window.....	13
Evaluation Board Circuitry.....	6	Exiting the Software.....	15
Sockets and Connectors.....	6	Evaluation Board Schematics and Artwork.....	16
Test Points.....	6	Ordering Information.....	19
Evaluation Board Software.....	7	Bill of Materials.....	19
Software Installation Procedures.....	7		

REVISION HISTORY**11/2022—Rev. A to Rev. B**

Changes to General Description Section.....	1
Changes to AD7386 Description Section.....	4

10/2019—Rev. 0 to Rev. A

Changes to General Description Section.....	1
---	---

8/2019—Revision 0: Initial Version

QUICK START GUIDE

The EVAL-AD7386FMCZ is powered by the [EVAL-SDP-CH1Z](#) board by default. External power supplies can be applied. See [Table 1](#) for a description of connectors and [Table 2](#) for the link configuration required. Use the following steps to evaluate the AD7386:

1. Download and install the [ACE](#) evaluation software, available on the [AD7386](#) product page. Details of this installation are available on the evaluation board box internal label. Ensure that the [EVAL-SDP-CH1Z](#) board is disconnected from the USB port of the PC while installing the software. The PC may need a restart after installation.
2. Ensure that the link options are configured as detailed in [Table 2](#).
3. Connect the [EVAL-SDP-CH1Z](#) board to the EVAL-AD7386FMCZ, as shown in [Figure 2](#).
4. Connect the [EVAL-SDP-CH1Z](#) board to the PC via the USB cable. If using Windows® XP, search for the [EVAL-SDP-CH1Z](#) drivers. Choose to automatically search for the drivers for the [EVAL-SDP-CH1Z](#) board if prompted by the operating system.
5. Copy the ACE plugins file, **Board.AD738x**, and the **Chip.AD738x** folder from the FTP site to the **C:\ProgramData\Analog Devices\ACE\Plugins** folder.
6. Launch the [ACE](#) evaluation software from the **ACE** subfolder in the **Analog Devices** folder in the **All Programs** menu.
7. Connect an input signal to the $A_{IN}A0$, $A_{IN}A1$, $A_{IN}B0$, or $A_{IN}B1$ channel.

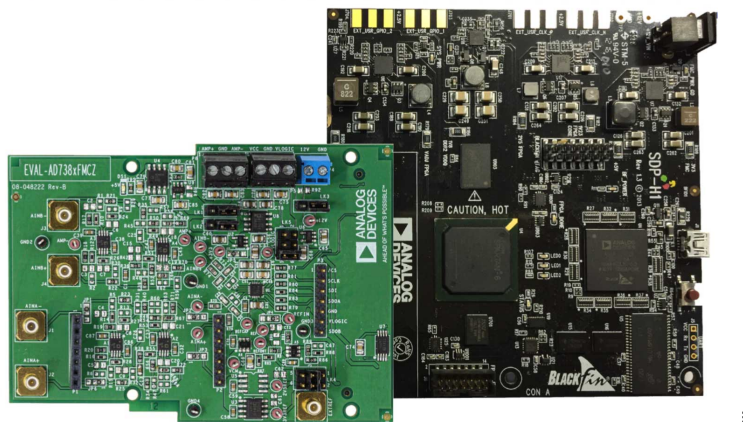

Figure 2. EVAL-AD7386FMCZ Evaluation Board (Left) Connected to the [EVAL-SDP-CH1Z](#) Board (Right)

EVALUATION BOARD HARDWARE

AD7386 DESCRIPTION

The AD7386 is a 16-bit, 4-channel, dual, simultaneous sampling, high speed, low power, successive approximation ADC and features a throughput rate of 4 MSPS. The analog input type is single-ended. The AD7386 can accept a wide common-mode input voltage and is sampled and converted on the falling edge of CS.

The AD7386 has an optional integrated, on-chip, oversampling block to improve dynamic range and reduce noise at lower bandwidths. An internal 2.5 V reference is included. Alternatively, an external reference up to 3.3 V can be used.

The conversion process and data acquisition use standard control inputs, allowing easy interfacing to microprocessors or digital signal processors (DSPs). The AD7386 is compatible with 1.8 V, 2.5 V, and 3.3 V interfaces, using the separate logic supply.

The AD7386 is available in a 16-lead LFCSP with operation specified from -40°C to +125°C.

POWER SUPPLIES

The EVAL-AD7386FMCZ operates from a 12 V power supply. Ensure that all link positions are set according to the required operating mode before applying power and signals to the EVAL-AD7386FMCZ. See Table 2 for the complete list of link options.

The EVAL-AD7386FMCZ is powered by the EVAL-SDP-CH1Z board by default. External power supplies can be applied to the board. See Table 1 for a description of the connectors used and Table 2 for the link configurations required.

Table 1. Optional External Power Supplies

Power Supply	Connector	Voltage Range (V)	Description
12V	P4-1	12 ± 10%	Main board power supply for all internal voltage regulators
GND	P4-2	0	Ground
VCC	P5-1	3.3 ± 5%	ADC analog power supply
GND	P5-2	0	Ground
VLOGIC	P5-3	2.3 ± 5%	Digital serial peripheral input (SPI) power supply
AMP-	P6-1	5 ± 5%	Amplifier positive power supply
GND	P6-2	0	Ground
AMP+	P6-3	-2.5 ± 5%	Amplifier negative power supply

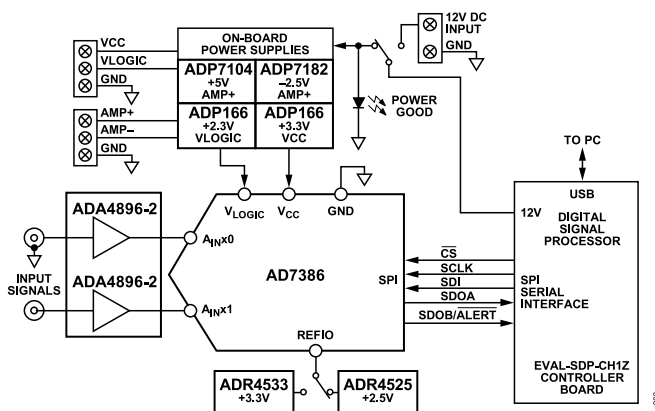

Figure 3. EVAL-AD7386FMCZ Functional Block Diagram

EVALUATION BOARD HARDWARE

LINK CONFIGURATION OPTIONS

Multiple link options must be set correctly to select the appropriate operating setup before using the EVAL-AD7386FMCZ. The functions of these options are detailed in [Table 2](#).

Setup Conditions

Ensure that all link positions are set as required by the selected operating mode before applying power and signals to the evaluation

boards. [Table 2](#) shows the default positions of the links when the EVAL-AD7386FMCZ is packaged.

Table 2. Link Options for EVAL-AD7386FMCZ

Link Name	Function	Position ¹	Description
LK1	Internal or external selection for the negative supply of the amplifier	1	Use the internal -5 V from the ADP7182 for AMP-. Change to Position 3 to use the external supply.
LK2	Internal or external selection for the positive supply of the amplifier	1	Use the internal 5 V from the ADP7104 for AMP+. Change to Position 3 to use external supply.
LK3	Internal or external selection for 12 V supply	1	Use the 12 V power supply from the EVAL-SDP-CH1Z . Change to Position 3 to use the external supply.
LK4	Selection for external voltage reference (V_{REF}) of ADC	3-4	Use the internal 3.3 V from the ADR4533 for V_{REF} . Change to Position 1-2 (link shorted on Pin 1 and Pin 2) to use the external reference. Change to Position 5-6 (link shorted on Pin 5 and Pin 6) to use the ADR4525 .
LK5	Selection for logic voltage (V_{LOGIC}) of ADC	3-4	Use internal 2.3 V from the ADP166 for V_{LOGIC} . Change to Position 1-2 to use the external reference. Change to Position 5-6 to use V_{LOGIC} from the EVAL-SDP-CH1Z .
JP1, JP2	Amplifier selection for A_{INA-}	1 (SMD resistor)	Use on-board amplifier for signal conditioning. Change to Position 3 to use an amplifier mezzanine card (AMC).
JP3, JP6	Amplifier selection for A_{INA+}	1 (SMD resistor)	Use on-board amplifier for signal conditioning. Change to Position 3 to use an AMC.
JP4	Internal or external selection for V_{REF} of ADC	3 (SMD resistor)	Use the internal voltage reference of the AD7386 . Change to Position 2 to use an external voltage reference.
JP5	Internal or external selection for V_{CC}	1 (SMD resistor)	Use internal 3.3 V from the ADP166 for V_{CC} . Change to Position 3 to use an external V_{CC} .

¹ Position refers to the pin on the link. For example, Position 3-4 means Pin 3 and Pin 4 of the link is shorted by a header stub, and the SMD resistor is the surface-mount device resistor.

EVALUATION BOARD CIRCUITRY

SOCKETS AND CONNECTORS

The connectors and sockets on the EVAL-AD7386FMCZ are described in [Table 3](#).

The default interface to the EVAL-AD7386FMCZ is via the 160-way connector, which connects the EVAL-AD7386FMCZ to the [EVAL-SDP-CH1Z](#). If using the EVAL-AD7386FMCZ in standalone mode, communication is achieved via the P3 header pins.

TEST POINTS

There are several test points and single in line (SIL) headers on the EVAL-AD7386FMCZ. These test points provide easy access to the signals from the evaluation board for probing, evaluation, and debugging.

Table 3. On-Board Connectors

Connector	Function
J1	Negative analog input for Channel A
J2	Positive analog input for Channel A
J3	Negative analog input for Channel B
J4	Positive analog input for Channel B
P1	Amplifier mezzanine card inputs
P2	Amplifier mezzanine card outputs
P3	Digital SPI signals
P4	Main board power supply (12 V) for all internal voltage regulators
P5	ADC power supply and digital SPI power supply
P6	Amplifier power supply
P7	Field-programmable gate array (FPGA) mezzanine card (FMC) to low pin count (LPC) connector
EXTREF	External voltage reference

EVALUATION BOARD SOFTWARE

SOFTWARE INSTALLATION PROCEDURES

Download the [ACE](#) evaluation software from the EVAL-AD7386FMCZ product page and install this software on a PC before using the EVAL-AD7386FMCZ evaluation board.

Take the following two steps to complete the installation process:

1. Install the [ACE](#) evaluation software
2. Install the [EVAL-SDP-CH1Z](#) driver

Warning

The evaluation board software and drivers must be installed before connecting the EVAL-AD7386FMCZ and the [EVAL-SDP-CH1Z](#) to the USB port of the PC to ensure that the evaluation system is correctly recognized when the system is connected to the PC.

Installing the ACE Evaluation Software

To install the [ACE](#) evaluation software,

1. Download the [ACE](#) evaluation software to a Windows-based PC.
2. Double-click the **ACEInstall.exe** file to begin the installation. By default, the software is saved to the following location: **C:\Program Files (x86)\Analog Devices\ACE.**
3. A dialog box appears asking for permission to allow the program to make changes to the PC. Click **Yes** to begin the installation process.
4. Click **Next >** to continue the installation, as shown in [Figure 4](#).

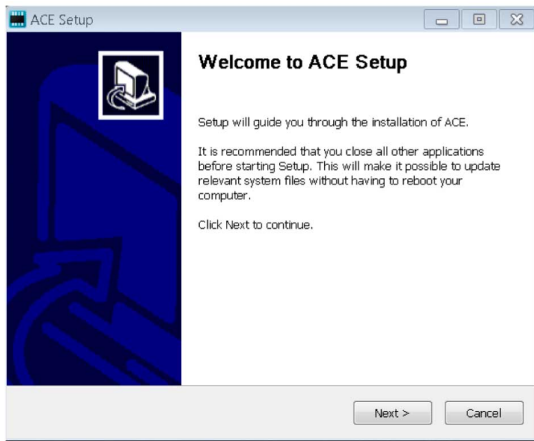

Figure 4. Evaluation Software Install Confirmation

5. The license agreement then pops up. Read the license and click **I Agree**.



Figure 5. License Agreement

6. Then, choose the installation location and click **Next >**.

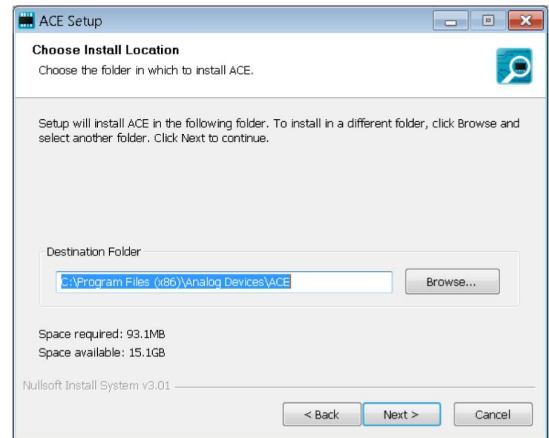

Figure 6. Choose Install Location

7. The components to install are preselected. Click **Install**.

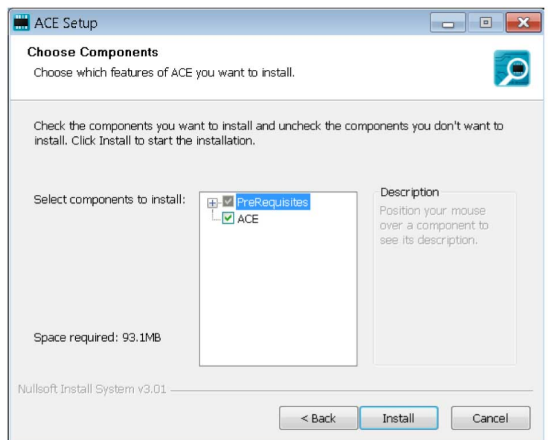

Figure 7. Choose Components

8. The **Windows Security** window then appears. Click **Install**.

EVALUATION BOARD SOFTWARE



Figure 8. Windows Security Window

9. The installation is now in progress, and no action is required.

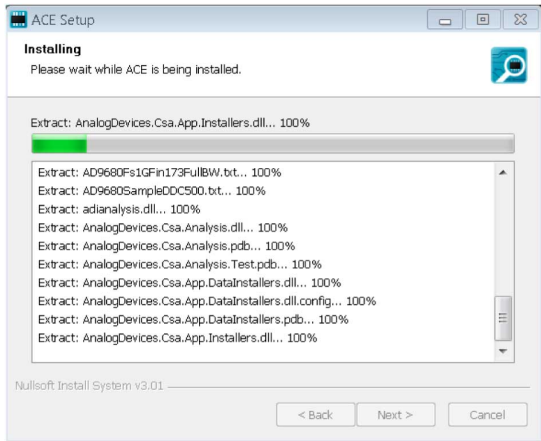

Figure 9. Installation in Progress

10. The **Installation Complete** window then appears. Click **Next >** and **Finish** to complete the installation.

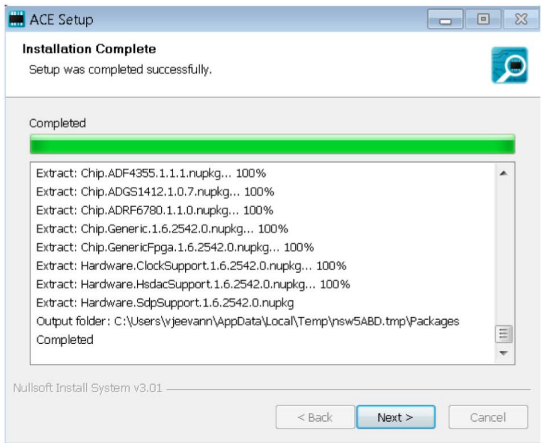

Figure 10. Installation Complete

EVALUATION BOARD SETUP PROCEDURES

The EVAL-AD7386FMCZ connects to the EVAL-SDP-CH1Z. The EVAL-SDP-CH1Z is the controller board, which is the communication link between the PC and the EVAL-AD7386FMCZ. Figure 2 shows a diagram of the connections between the EVAL-AD7386FMCZ evaluation board and the EVAL-SDP-CH1Z.

After following the instructions in the Software Installation Procedures section, set up the EVAL-AD7386FMCZ and the EVAL-SDP-

CH1Z as detailed in the Connecting the EVAL-AD7386FMCZ and EVAL-SDP-CH1Z to a PC section.

The evaluation software and drivers must be installed before connecting the EVAL-AD7386FMCZ and EVAL-SDP-CH1Z to the USB port of the PC. Installing the software and drivers prior to connection ensures that the evaluation system is correctly recognized when the system is connected to the PC.

Connecting the EVAL-AD7386FMCZ and EVAL-SDP-CH1Z to a PC

Take the following steps to connect the EVAL-AD7386FMCZ and EVAL-SDP-CH1Z to a PC:

1. Ensure that all configuration links are in the appropriate positions (see Table 2).
2. Connect the EVAL-AD7386FMCZ board securely to the 160-way connector on the EVAL-SDP-CH1Z.
3. Connect the EVAL-SDP-CH1Z board to the PC via the USB cable enclosed in the EVAL-SDP-CH1Z kit.

Note that the EVAL-AD7386FMCZ board does not require an external power supply adapter.

Verifying the Board Connection

Take the following steps to verify the board connection:

1. Allow the **Found New Hardware Wizard** to run after the EVAL-SDP-CH1Z board is plugged into the PC. If using Windows XP, search for the EVAL-SDP-CH1Z drivers. Choose to automatically search for the drivers for the EVAL-SDP-CH1Z board if prompted by the operating system.
2. Ensure that the EVAL-AD7386FMCZ evaluation board is connected to the PC correctly by using the **Device Manager** window. A dialog box may appear asking for permission to allow the program to make changes to the computer. Click **Yes**. The **Computer Management** window will appear. From the **System Tools** list, click **Device Manager**.
3. If the EVAL-SDP-CH1Z driver software is installed, and the EVAL-SDP-CH1Z board is connected to the PC correctly, **Analog Devices SDP-H1** appears nested under the **ADI Development Tools** in the **Device Manager** window, as shown in Figure 11.

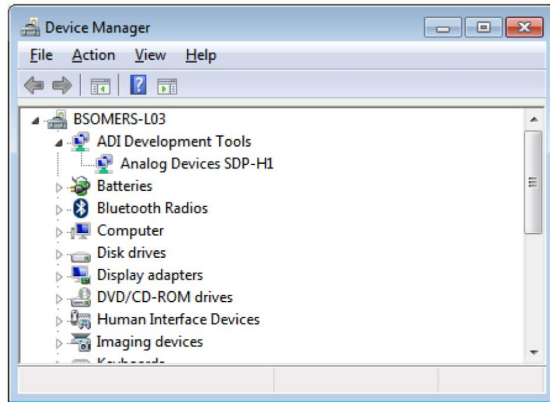
EVALUATION BOARD SOFTWARE

011

*Figure 11. Device Manager Window***Disconnecting the EVAL-AD7386FMCZ**

Before removing the EVAL-AD7386FMCZ evaluation board, always remove power from the [EVAL-SDP-CH1Z](#) or push the reset tact switch on the [EVAL-SDP-CH1Z](#), located alongside the mini USB port.

EVALUATION SOFTWARE OPERATION

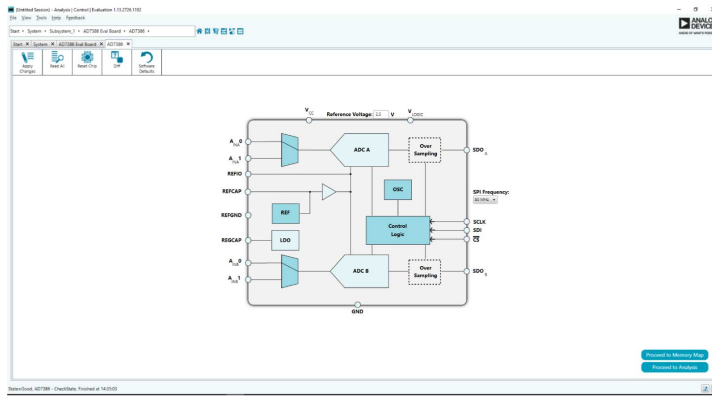

Figure 14. Chip View

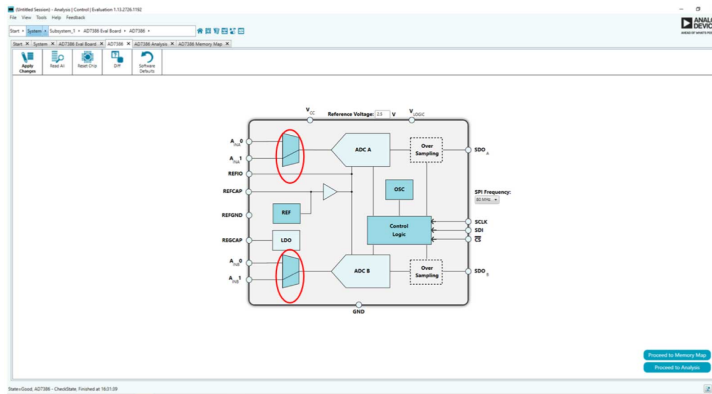

Figure 15. Channel Selection View

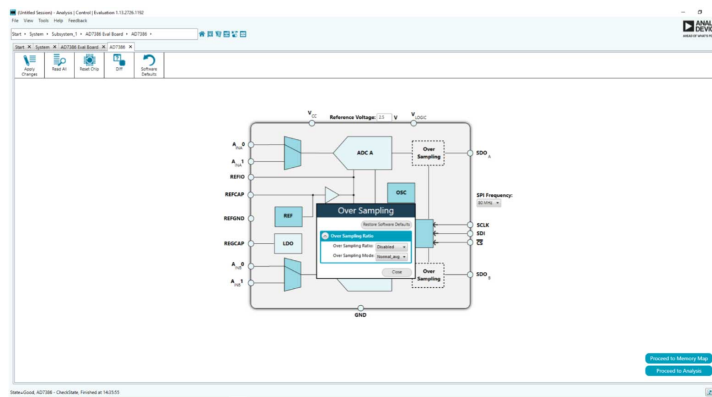

Figure 16. Over Sampling Pop-Up Configurable Window

DESCRIPTION OF CHIP VIEW WINDOW

Click the **AD7386** chip icon in the board view to open the window shown in [Figure 14](#). The chip view shows the configurable block diagram of the **AD7386**.

CHANNEL SELECTION

Click the multiplexer icons circled in red (see [Figure 15](#)) to select the ADC channel pairs for conversion (**A_{INA0}/A_{INB0}** and **A_{INA1}/A_{INB1}**).

EVALUATION SOFTWARE OPERATION

OVERSAMPLING

The [AD7386](#) offers an oversampling function on chip and has two user configurable oversampling modes, normal average and rolling average. Click the **OSC** block to configure the oversampling ratio.

REFERENCE

Click the **REF** block to select from an internal 2.5 V or external reference source for the ADC. An externally supplied reference can be in the 2.5 V to 3.3 V range.

SERIAL MODE

The [AD7386](#) offers an option to have a 1-wire or a 2-wire configuration for serial communication. Click the **Control Logic** block to configure this option.

Serial 2-Wire Mode

Configure 2-wire mode by setting the SDO bit in the CONFIGURATION2 register (Address 0x02) to 0. In 2-wire mode, the conversion result for ADC A is output on the SDOA pin, and the conversion result for ADC B is output on the SDOB/ALERT pin.

Serial 1-Wire Mode

In applications where slower throughput rates are allowed, or normal average oversampling is used, the serial interface can operate in 1-wire mode. In 1-wire mode, the conversion results from ADC A and ADC B are output on the serial output, SDOA. Additional SCLK cycles are required to propagate all data. ADC A data is output first, followed by ADC B conversion results.

DESCRIPTION OF MEMORY MAP WINDOW

Click **Proceed to Memory Map** in the bottom right corner of the chip view window to open the window shown in [Figure 17](#). The memory map shows all registers of the [AD7386](#).

Apply Changes

The registers are populated with default values when powered up. To implement the values changed in all the registers, click **Apply Changes** to write to the registers.

Apply Selected

To implement changes on a selected register when the values of a register are changed, click **Apply Selected** to write the new value on the selected register to the [AD7386](#).

Read All

Click **Read All** to read the values of all the registers from the chip.

Read Selected

Click **Read Selected** to read the selected register from the chip.

Reset Chip

Click **Reset Chip** to prompt the software to reset the [AD7386](#).

Diff

Click **Diff** to check for differences in register values between the software and the chip.

Software Defaults

To revert all the register values to their defaults, click **Software Defaults** and then **Apply Changes** to write to the [AD7386](#).

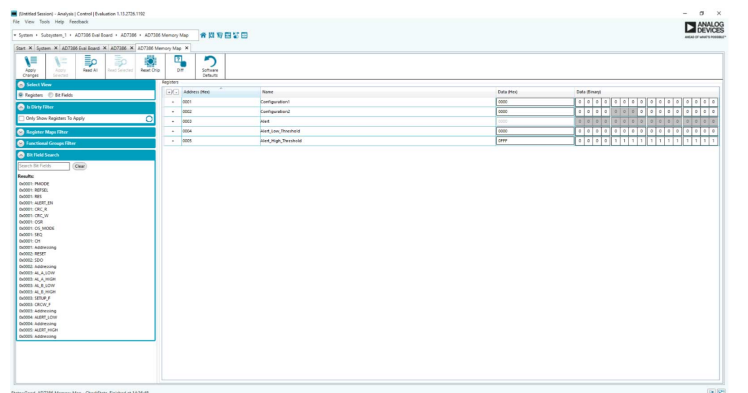

Figure 17. Memory Map View

EVALUATION SOFTWARE OPERATION

DESCRIPTION OF ANALYSIS WINDOW

Click **Proceed to Analysis** in the chip view to open the window shown in [Figure 18](#). The analysis view contains the **Waveform** tab, **Histogram** tab, and **FFT** tab.

Waveform Tab

The **Waveform** tab displays data in the form of time vs. discrete data values with the results (see [Figure 19](#)). The **CAPTURE** pane contains capture settings that apply to the registers automatically before data capture.

CAPTURE Pane

General Capture Settings

The **Sample Count** dropdown list allows the user to select the number of samples per channel per capture.

The **SPI Frequency (MHz)** dropdown list allows the user to select the SPI clock frequency used to transfer data between the FPGA device and the [AD7386](#) during device register reads and writes and during data capture. This frequency must be set relatively higher than the set throughput rate.

The user can enter the input sample frequency in kSPS in the **Sampling Frequency(kSPS)** box. Refer to the [AD7386](#) data sheet to determine the maximum sampling frequency for the selected mode.

Device Settings

The **Over Sampling Ratio** box includes options to disable the oversampling ratio function (**Disabled**) or to set the oversampling ratio

between 2 and 32, which, when selected, automatically enables the oversampling ratio function and provides improved signal to noise ratio (SNR) performance. Refer to the [AD7386](#) data sheet to determine the maximum oversampling ratio for the selected oversampling mode.

When an option other than **Disabled** is selected, a drop down list appears. Select **18-Bit Resolution** to enter 18-bit resolution mode. The resolution boost is used in conjunction with the oversampling rate to provide two extra bits of resolution.

The **Over Sampling Mode** dropdown list allows the user to select the mode of oversampling. This setting is only applicable when oversampling is enabled.

Run Once

Click **Run Once** to start a data capture of the samples at the sample rate specified in the **Sample Count** dropdown list box. These samples are stored on the FPGA device and are transferred to the PC only when the sample frame is complete.

Run Continuously

Click **Run Continuously** to start a data capture that gathers samples continuously with one batch of data at a time. This option runs the **Run Once** operation continuously.

RESULTS Pane

Display Channels

Display Channels allows the user to select the channels to capture. The channel data is shown only if that channel is selected before the capture.

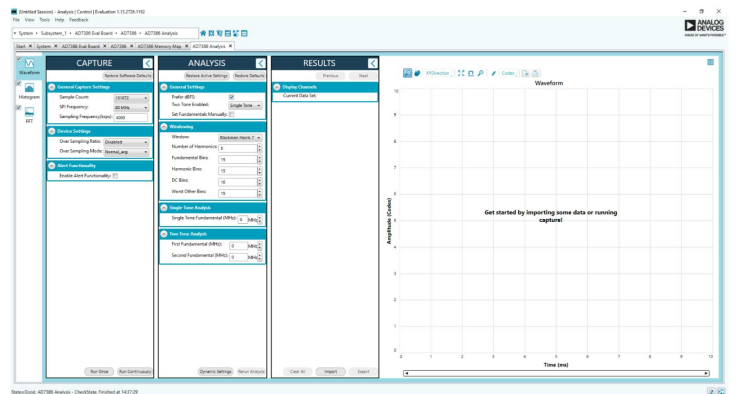

Figure 18. Analysis View

EVALUATION SOFTWARE OPERATION

Waveform Results

Waveform Results displays amplitude, sample frequency, and noise analysis data for the selected channels.

Export Capture Data

Click **Export** to export the captured data. The waveform, histogram, and FFT data are stored in .xml files along with the values of parameters at capture.

Waveform Graph

The data **Waveform** graph shows each successive sample of the ADC output. The user can zoom and pan the waveform using the embedded waveform tools. The channels to display can be selected in the **Display Channels** section.

Display Units and Axis Controls

Click the display units dropdown list to select whether the data graph displays in units of hexadecimal, volts, or codes. The axis controls are dynamic.

When selecting either y-scale dynamic or x-scale dynamic, the corresponding axis width automatically adjusts to show the entire range of the ADC results after each batch of samples.

Histogram Tab

The **Histogram** tab contains the histogram graph and the results pane, as shown in [Figure 20](#).

RESULTS Pane

The **RESULTS** pane displays the information related to the dc performance.

Histogram Graph

The histogram graph displays the number of hits per code within the sampled data. This graph is useful for dc analysis and indicates the noise performance of the device.



Figure 19. Waveform Tab

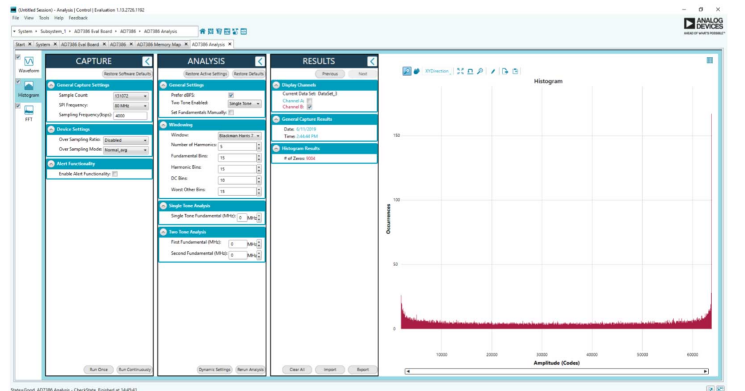

Figure 20. Histogram Tab

EVALUATION SOFTWARE OPERATION

FFT Tab

Figure 21 shows the FFT tab, which displays fast Fourier transform (FFT) information for the last batch of samples gathered.

ANALYSIS Pane

General Settings

This section sets up the preferred configuration of the FFT analysis, including the number of tones analyzed and whether the fundamental is set manually.

Windowing

This section sets up the preferred windowing type used in the FFT analysis. The number of harmonic bins and fundamental bins that must be included in the analysis are also set up in this section.

Single Tone Analysis and Two Tone Analysis

These sections set up the fundamental frequency included in the FFT analysis. Type in the values for the **Two Tone Analysis** section when two frequencies are analyzed.

RESULTS Pane

Signal

Signal displays the sample frequency, fundamental frequency, and fundamental power.

Noise

Noise displays the SNR and other noise performance results.

Distortion

Distortion displays the harmonic content of the sampled signal and dc power when viewing the FFT analysis.

EXITING THE SOFTWARE

To exit the software, click **File** and **Exit**.

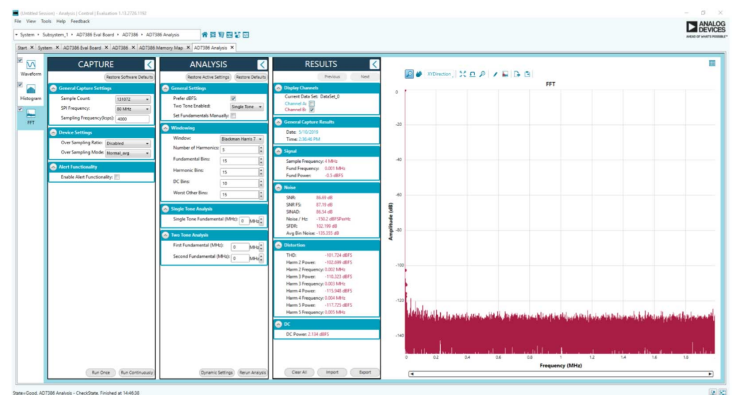

Figure 21. FFT Tab

EVALUATION BOARD SCHEMATICS AND ARTWORK

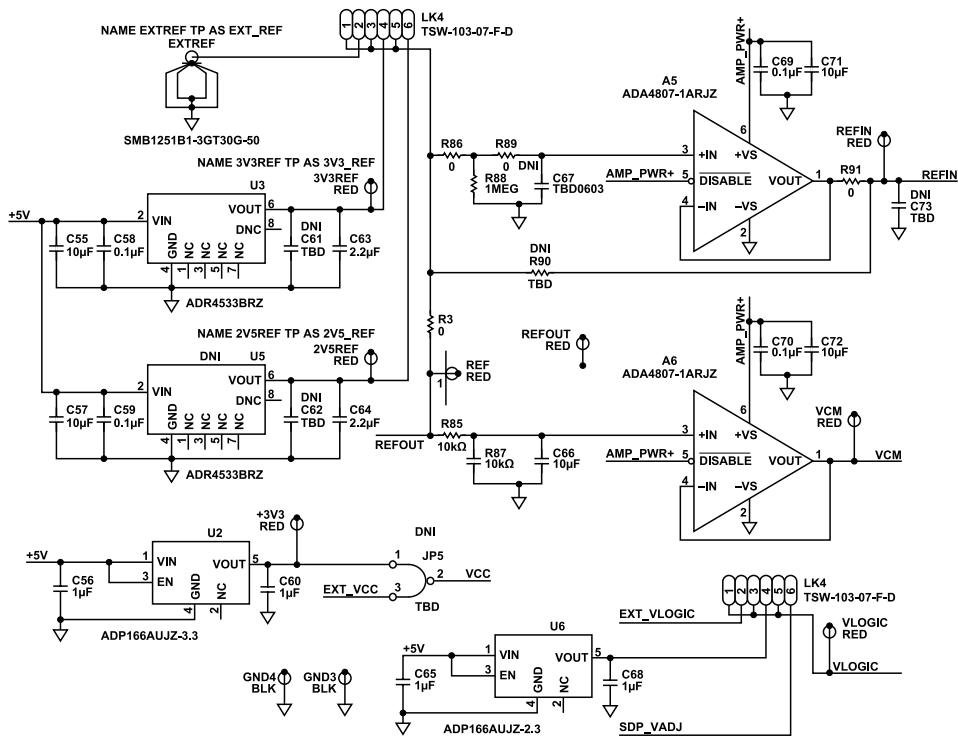

Figure 23. ADC Evaluation Board, Common-Mode and Reference Buffers

82

EVALUATION BOARD SCHEMATICS AND ARTWORK

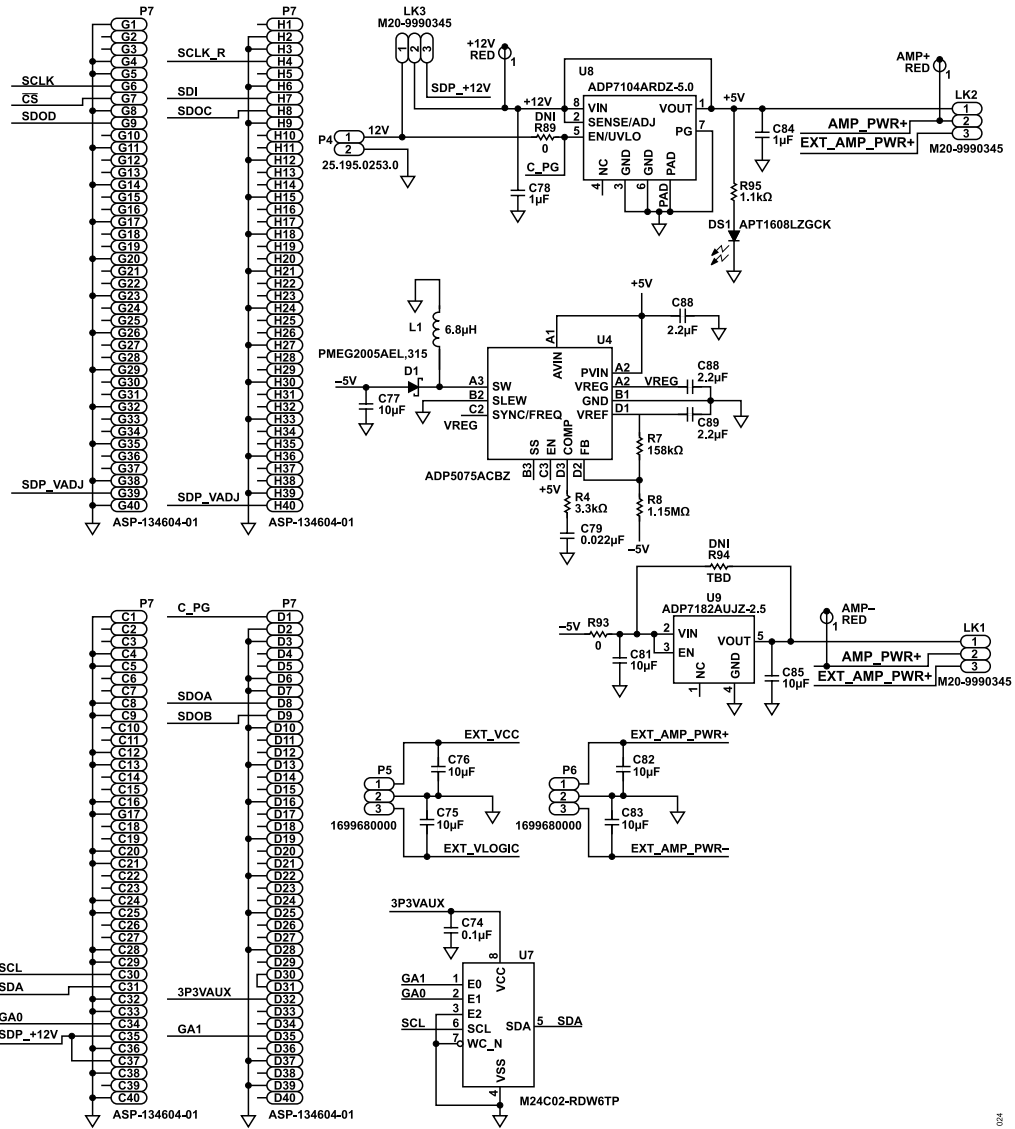

Figure 24. ADC Evaluation Board, Power Supply

ORDERING INFORMATION

BILL OF MATERIALS

Table 4. Bill of Materials

Reference Designator	Description	Manufacturer	Part Number
U1	Single-ended input, dual, simultaneous sampling 16-bit successive approximation register (SAR) ADC	Analog Devices	AD7386
U2	Very low quiescent current, 150 mA, low dropout (LDO) regulator, 3.3 V output voltage	Analog Devices	ADP166
U3	Ultralow noise, high accuracy voltage reference	Analog Devices	ADR4533
U4	800 mA, dc-to-dc inverting regulator	Analog Devices	ADP5075
U6	Very low quiescent current, 150 mA, LDO regulator, 2.3 V output	Analog Devices	ADP166
U7	2 kb serial I ² C bus electronically erasable programmable read only memory (EEPROM), 1.8 V to 5.5 V	ST Microelectronics	M24C02-R
U8	Low noise, complementary metal-oxide semiconductor (CMOS) LDO regulator, 5.0 V output voltage	Analog Devices	ADP7104
U9	Low noise, linear regulator	Analog Devices	ADP7182
A1, A2, A3, A4	Low power, rail to rail op amps	Analog Devices	ADA4896-2
A5, A6	180 MHz rail-to-rail input and output amplifier	Analog Devices	ADA4807-1
C1, C10, C11, C12, C13, C32, C33, C38, C39, C45, C47, C58, C59, C69, C70, C86, C87	0.1 μF, capacitors, ceramic chip multilayer, X7R	Vishay	VJ0603Y104KXAC31X
C22, C23, C29, C30	330 pF, ceramic capacitors, NP0, 0603	Kemet	C0603C331J5GACTU
C27, C28, C34, C35, C41, C42, C49, C50	10 μF, ceramic capacitors, multilayer, X5R	TDK	C2012X5R1E106K085AC
C31, C63, C64	2.2 μF, multilayer ceramic capacitors, X5R, 0805	Taiyo Yuden	LMK212BJ225KD-T
C37, C46, C52, C56, C60, C65, C68, C78, C84	1 μF, chip ceramic capacitors, X7R	Murata	GCM21BR71E105KA56L
C48, C51, C74	0.1 μF, ceramic capacitors, X7R	Kemet	C0805C104J5RACTU
C55, C57, C66, C71, C72, C75, C76, C77, C80, C81, C82, C83, C85	10 μF, ceramic capacitors, X5R, general-purpose	Murata	GRM21BR61C106KE15L
C79	0.022 μF, ceramic capacitor, X7R, 0402	AVX	0402YC223KAT2A
C88, C89	2.2 μF, ceramic capacitors, X5R, general-purpose	Murata	GRM155R60J225KE95D
D1	Schottky diode, barrier rectifier	NXP Semiconductors	PMEG2005AEL,315
DS1	LED chip lamp green 525 nm (clear)	Kingbright Electronic	APT1608LZGCK
EXTREF, J1, J2, J3, J4	Connector PCB SMB coaxial straight jacks	Amphenol	SMB1251B1-3GT30G-50
GND1, GND2, GND3, GND4	Connector PCB test points, black	Components Corporation	TP-104-01-00
L1	Inductor power, wound ferrite	TDK	VLF252015MT-6R8M
LK1, LK2, LK3, LK6	Connector PCB headers, 2.54 mm pitch, SIL, vertical printed circuit tail	Harwin	M20-9990345
LK4, LK5	Connector PCB, 6-position, male headers, unshrouded double row straight, 2.54 mm pitch, 5.84 mm post height, 2.54 mm solder tail	Samtec Inc.	TSW-103-07-F-D
P1	Connector PCB, 0.025 inch square, post socket	Samtec Inc.	SSW-107-01-T-S
P2, P3	Connector PCB header, low profile	Samtec Inc.	TLW-107-05-G-S
P4	Connector PCB terminal block, 3.5 mm pitch	Wieland Electric GMBH	25.195.0253.0
P5, P6	Connector PCB terminals, 3.5 mm pitch, three-pole	Weidmuller	1699680000
P7	Connector PCB, single-ended array, male, 160-position	Samtec Inc.	ASP-134604-01
R10, R12, R14, R16, R24, R26, R27, R28	49.9 Ω resistors, precision thick film chip, R0603	Panasonic	ERJ-3EKF49R9V
R17, R18, R19, R20, R85, R87	10 kΩ resistors, precision thick film chip, R0603	Panasonic	ERJ-3EKF1002V
R3, R21, R22, R23, R25, R33, R34, R35, R36, R37, R38, R39, R40, R50, R52, R54, R56, R65, R66, R67,	0 Ω resistors, film, SMD, 0603	Multicomp	MC0603WG00000T5E-TC

ORDERING INFORMATION

Table 4. Bill of Materials

Reference Designator	Description	Manufacturer	Part Number
R68, R69, R70, R71, R72, R77, R79, R80, R81, R86, R89, R91, R93			
R4	3.3 kΩ resistor, precision thick film chip	Panasonic	ERJ-2RKF3301X
R49, R51, R53, R55	200 Ω resistors, chip, SMD, 0603	Panasonic	ERJ-3EKF2000V
R7	158 kΩ resistor, precision thick film chip	Panasonic	ERJ-2RKF1583X
R73, R74, R75, R76	33 Ω resistors, film, SMD, 0603	Multicomp	MC 0.063W 0603 1% 33R
R8	1.15 MΩ resistor, thick film chip, general-purpose	Yageo	RC0402FR-071M15L
R83, R84	100 Ω resistors, precision thick film chip, R0603	Panasonic	ERJ-3EKF1000V
R88	1 MΩ resistor, precision thick film chip, R0603	Panasonic	ERJ-3EKF1004V
R95	1.1 kΩ resistor, thick film chip	Bourns	CR0603-FX-1101ELF

I²C refers to a communications protocol originally developed by Philips Semiconductors (now NXP Semiconductors).

**ESD Caution**

ESD (electrostatic discharge) sensitive device. Charged devices and circuit boards can discharge without detection. Although this product features patented or proprietary protection circuitry, damage may occur on devices subjected to high energy ESD. Therefore, proper ESD precautions should be taken to avoid performance degradation or loss of functionality.

Legal Terms and Conditions

By using the evaluation board discussed herein (together with any tools, components documentation or support materials, the "Evaluation Board"), you are agreeing to be bound by the terms and conditions set forth below ("Agreement") unless you have purchased the Evaluation Board, in which case the Analog Devices Standard Terms and Conditions of Sale shall govern. Do not use the Evaluation Board until you have read and agreed to the Agreement. Your use of the Evaluation Board shall signify your acceptance of the Agreement. This Agreement is made by and between you ("Customer") and Analog Devices, Inc. ("ADI"), with its principal place of business at Subject to the terms and conditions of the Agreement, ADI hereby grants to Customer a free, limited, personal, temporary, non-exclusive, non-sublicensable, non-transferable license to use the Evaluation Board FOR EVALUATION PURPOSES ONLY. Customer understands and agrees that the Evaluation Board is provided for the sole and exclusive purpose referenced above, and agrees not to use the Evaluation Board for any other purpose. Furthermore, the license granted is expressly made subject to the following additional limitations: Customer shall not (i) rent, lease, display, sell, transfer, assign, sublicense, or distribute the Evaluation Board; and (ii) permit any Third Party to access the Evaluation Board. As used herein, the term "Third Party" includes any entity other than ADI, Customer, their employees, affiliates and in-house consultants. The Evaluation Board is NOT sold to Customer; all rights not expressly granted herein, including ownership of the Evaluation Board, are reserved by ADI. CONFIDENTIALITY. This Agreement and the Evaluation Board shall all be considered the confidential and proprietary information of ADI. Customer may not disclose or transfer any portion of the Evaluation Board to any other party for any reason. Upon discontinuation of use of the Evaluation Board or termination of this Agreement, Customer agrees to promptly return the Evaluation Board to ADI. ADDITIONAL RESTRICTIONS. Customer may not disassemble, decompile or reverse engineer chips on the Evaluation Board. Customer shall inform ADI of any occurred damages or any modifications or alterations it makes to the Evaluation Board, including but not limited to soldering or any other activity that affects the material content of the Evaluation Board. Modifications to the Evaluation Board must comply with applicable law, including but not limited to the RoHS Directive. TERMINATION. ADI may terminate this Agreement at any time upon giving written notice to Customer. Customer agrees to return to ADI the Evaluation Board at that time. LIMITATION OF LIABILITY. THE EVALUATION BOARD PROVIDED HEREUNDER IS PROVIDED "AS IS" AND ADI MAKES NO WARRANTIES OR REPRESENTATIONS OF ANY KIND WITH RESPECT TO IT. ADI SPECIFICALLY DISCLAIMS ANY REPRESENTATIONS, ENDORSEMENTS, GUARANTEES, OR WARRANTIES, EXPRESS OR IMPLIED, RELATED TO THE EVALUATION BOARD INCLUDING, BUT NOT LIMITED TO, THE IMPLIED WARRANTY OF MERCHANTABILITY, TITLE, FITNESS FOR A PARTICULAR PURPOSE OR NON-INFRINGEMENT OF INTELLECTUAL PROPERTY RIGHTS. IN NO EVENT WILL ADI AND ITS LICENSORS BE LIABLE FOR ANY INCIDENTAL, SPECIAL, INDIRECT, OR CONSEQUENTIAL DAMAGES RESULTING FROM CUSTOMER'S POSSESSION OR USE OF THE EVALUATION BOARD, INCLUDING BUT NOT LIMITED TO LOST PROFITS, DELAY COSTS, LABOR COSTS OR LOSS OF GOODWILL. ADI'S TOTAL LIABILITY FROM ANY AND ALL CAUSES SHALL BE LIMITED TO THE AMOUNT OF ONE HUNDRED US DOLLARS (\$100.00). EXPORT. Customer agrees that it will not directly or indirectly export the Evaluation Board to another country, and that it will comply with all applicable United States federal laws and regulations relating to exports. GOVERNING LAW. This Agreement shall be governed by and construed in accordance with the substantive laws of the Commonwealth of Massachusetts (excluding conflict of law rules). Any legal action regarding this Agreement will be heard in the state or federal courts having jurisdiction in Suffolk County, Massachusetts, and Customer hereby submits to the personal jurisdiction and venue of such courts. The United Nations Convention on Contracts for the International Sale of Goods shall not apply to this Agreement and is expressly disclaimed.

