

# CCD Series

## Safety Standard Recognized Ceramic Capacitors

**TRIGON**  
COMPONENTS



### FEATURES

- Complying with IEC60384-14 4<sup>th</sup> Edition
- Class X1Y1 and Class X1Y2
- Dielectric Strength: AC2600V (r.m.s) for X1Y2 and AC4000V (r.m.s) for X1Y1
- High Reliability
- Coated With Flame-Retardant Epoxy Resin (Conforming to UL94V-0 Standard)
- RoHS Compliant

### APPLICATIONS

- Ideal for use as X/Y capacitor for AC Line Filter and Primary/Secondary Coupling on Switching Power Supplies and AC adapters
- Across-The-Line
- Antenna-Coupling
- Line-By-Pass

### ORDERING CODE

**CCD - 1 09 B 101 K H 7 2**  
(1) (2) (3) (4) (5) (6) (7) (8) (9)

- (1) Ceramic Disc Capacitor
- (2) Class Type
- (3) Diameter Code
- (4) Ceramic Dielectric
- (5) Capacitance Code
- (6) Tolerance Code
- (7) Lead Style
- (8) Lead Spacing
- (9) Lead Length or Taping

※ Please refer to Ordering Code document CCD\_Safety-Order for more ordering options.

### Configuration

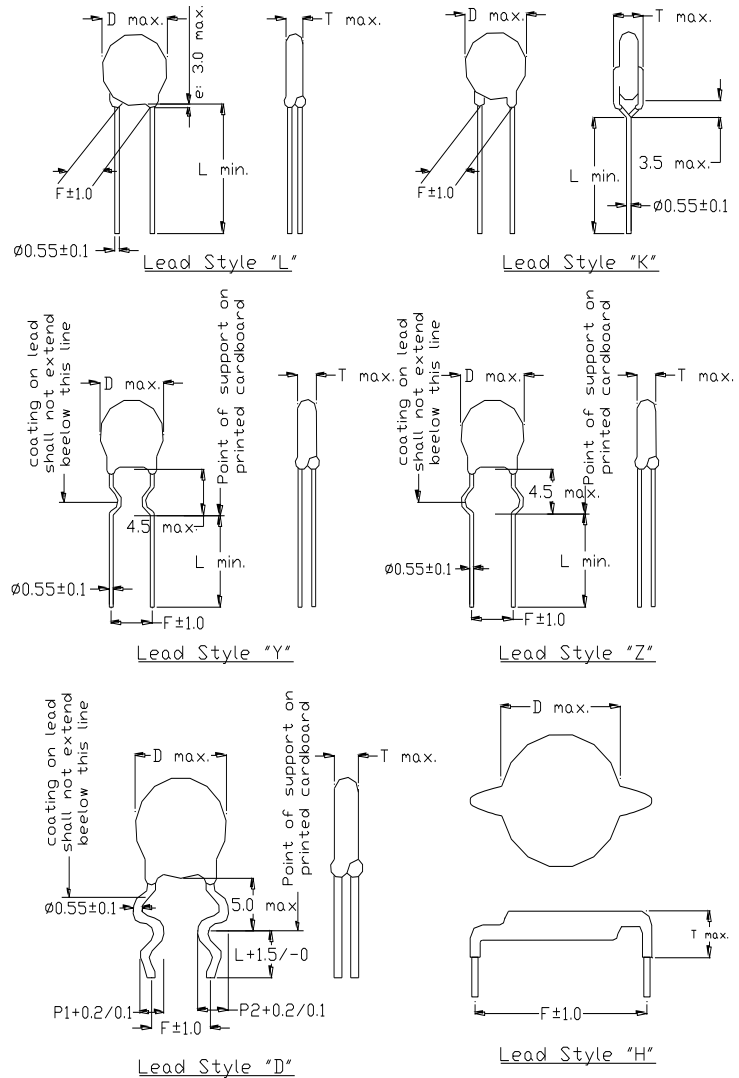

Capacitor

### Approval Standard and Recognized Number

Approval Agency	Number	X1/Y1	X1/Y2
VDE/ENEC10	40040454	CCD-1	-
	40046396		
	40040445	-	CCD-2
	40046520		
CSA	222903	CCD-1	CCD-2
UL	E197459	CCD-1	CCD-2

# CCD Series

## Safety Standard Recognized Ceramic Capacitors

**TRIGON**  
COMPONENTS

Capacitor

### Specification

Characteristics	Class X1, Y1	Class X1, Y2
Capacitance Range	100pF to 4700pF	5.1pF to 10000pF
Operating Temperature Range	-40°C to 125°C	Y5P, Y5V, Y5U: -40°C to 125°C COG, X7R: -55°C to 125°C SL: +40°C to +125°C
Rated Voltage	X1: 760/400VAC, Y1: 500/250VAC	X1: 440/400VAC, Y2: 300/250VAC
Dielectric Withstanding Voltage	4000VAC for 1 minute	2600VAC for 1 minute
Capacitance	Within the specified tolerance Y5P, Y5U, Y5V, X7R measured at 1KHz ± 20% COG measured at 1MHz ± 20% Both are 1 Vrms, 25°C	
Dissipation Factor (tan δ)	Tanδ ≤ 2.5% for char. Y5P, Y5U, Y5V, X7R measured at 1KHz ± 20% COG measured at 1MHz ± 20% Both are 1 Vrms, 25°C, Quality Factor ≥ 600 for char.	
Insulation Resistance	10,000 MΩ min. at 500VDC	

### Class X1, Y1

Part Number	Temp. Char.	Cap.(pF)	Cap. Tol.	D (Max. mm)	F (mm)	T (Max. mm)	Φd (mm)
CCD-107S100J□□□	S (SL)	10	± 5%	7.0	10	5	0.55±0.1
CCD-107S150J□□□		15		7.0			
CCD-107S200J□□□		20		7.0			
CCD-107S220J□□□		22		7.0			
CCD-107S330J□□□		33		7.0			
CCD-108S470J□□□		47		8.0			
CCD-109S680J□□□		68		9.0			
CCD-109B101KK0□	B (Y5P) ± 10%	100	± 10%	9.0	10	8	
CCD-109B151KK0□		150					
CCD-109B221KK0□		220					
CCD-109B331KK0□		330					
CCD-109B471KK0□		470					
CCD-109B561K□□□		560					
CCD-110B821K□□□		820		10.0	5		
CCD-110B681KK0□		680					
CCD-111B102K□□□		1000		11.0			

# CCD Series

## Safety Standard Recognized Ceramic Capacitors

**TRIGON**  
COMPONENTS

Capacitor

Part Number	Temp. Char.	Cap.(p F)	Cap. Tol.	D (Max. mm)	F (mm)	T (Max. mm)	Φd (mm)
CCD-109E102MK0□	E (Y5U) + 20% -55%	1000	± 20%	9.0	10	8	0.55±0.1
CCD-111E152MK0□		1500		11.0			
CCD-112E222MK0□		2200		12.0			
CCD-114E332MK0□		3300		14.0			
CCD115E392MK0□		3900		15.0			
CCD-116E472MK0□		4700		16.0			
CCD-107F102K□□□	Y5V	1000	± 20%	7.0		5.5	
CCD-108F152K□□□		1500		8.0			
CCD-109F222K□□□		2200		9.0			
CCD-110F332K□□□		3300		10.0			
CCD-112F472K□□□		4700		12.0			

### Class X1, Y2

Part Number	Temp. Char.	Cap. (pF)	Cap. Tol.	D (Max. mm)	F (mm)	T (Max. mm)	Φd (mm)	
CCD-208C100JK□□	C(COG)	10	±5%	8.0	7.5	7	0.55±0.1	
CCD-208B5R1CK□□	B (Y5P) ±10%	5.1	±0.25pF ±10%					
CCD-208B100KK□□		10						
CCD-208B150KK□□		15						
CCD-208B180KK□□		18						
CCD-208B220KK□□		22						
CCD-208B101K□□□		100						
CCD-208B151K□□□		150						
CCD-208B221K□□□		220						
CCD-208B331K□□□		330						
CCD-208B471K□□□		470						
CCD-209B561K□□□		560						
CCD-209B681K□□□		680						
CCD-209B821K□□□		820						
CCD-210B102K□□□		1000						
CCD-207S150J□□□		S (SL)			15	±5%		7.0
CCD-207S200J□□□				20				
CCD-207S220J□□□	22							
CCD-207S330J□□□	33							
CCD-207S470J□□□	47							
CCD-208S680J□□□	68							
CCD-208E102M□□□	E (Y5U) +20% -55%	1000	±20%	8.0	7.5	8		
CCD-209E152M□□□		1500						
CCD-210E222M□□□		2200						
CCD-211E252M□□□		2500						
CCD-212E332M□□□		3300						
CCD-213E392M□□□		3900						
CCD-214E472M□□□		4700						
CCD-208F102M□□□		1000					±20%	8.0
CCD-208F152M□□□	1500							
CCD-209F222M□□□	2200							
CCD-210F332M□□□	3300							
CCD-211F392M□□□	3900							
CCD-212F472M□□□	4700							
CCD-216F103M□□□	10000							

# CCD Series

Safety Standard Recognized Ceramic Capacitors

TRIGON  
COMPONENTS

Typical characteristic curves  $\epsilon^\circ$

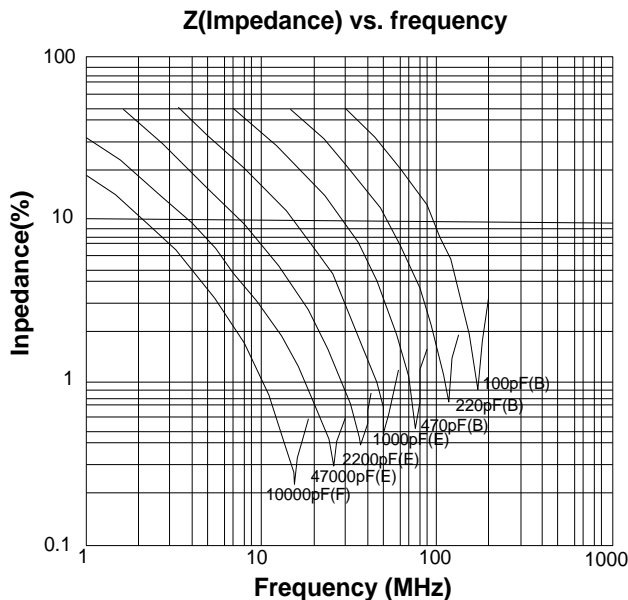
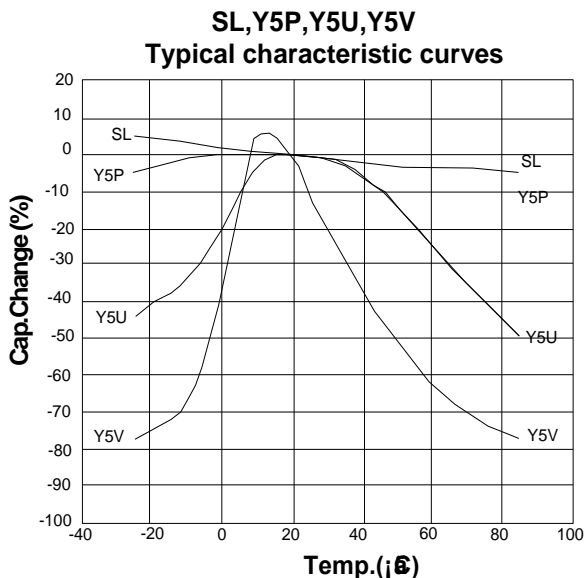

Note: Above data are just for reference not assured ones.

Leakage current characteristics (Type X1 Y1: 0~4000Vac):

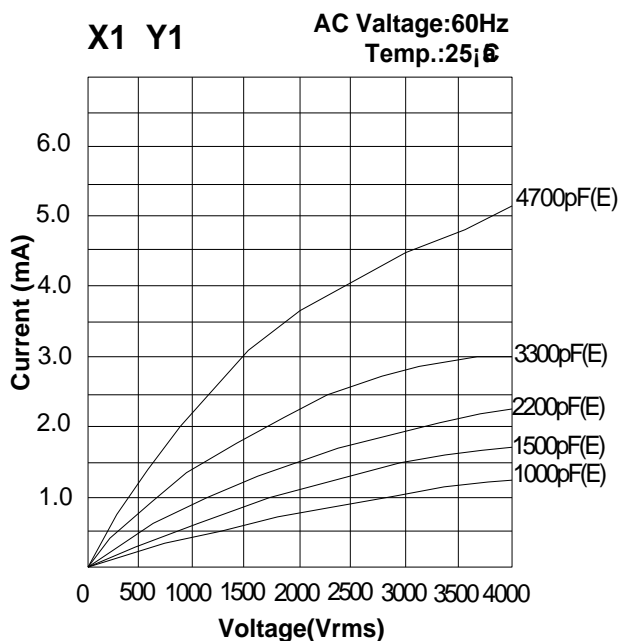
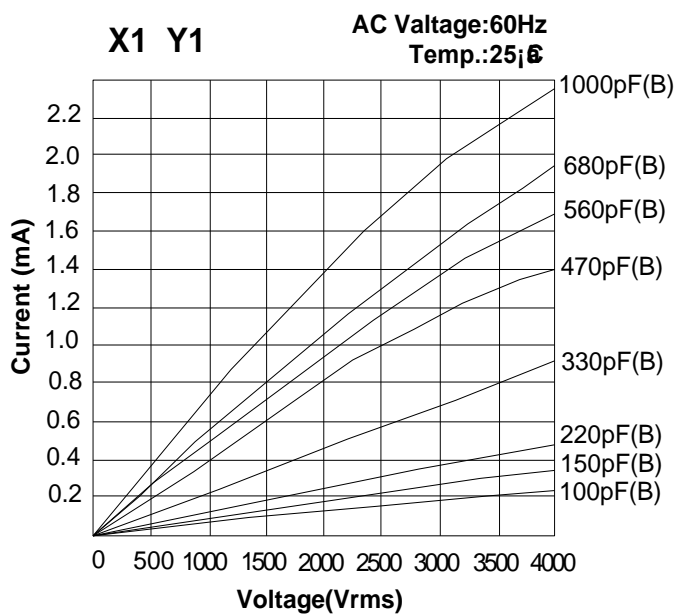

Note: Above data are just for reference not assured ones.

Capacitor

# CCD Series

Safety Standard Recognized Ceramic Capacitors

**TRIGON**  
COMPONENTS

Typical characteristic curves  $\epsilon^\circ$

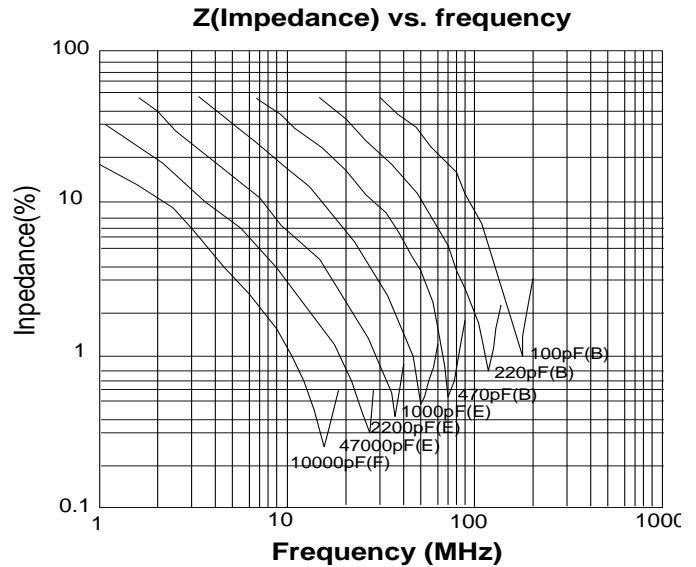
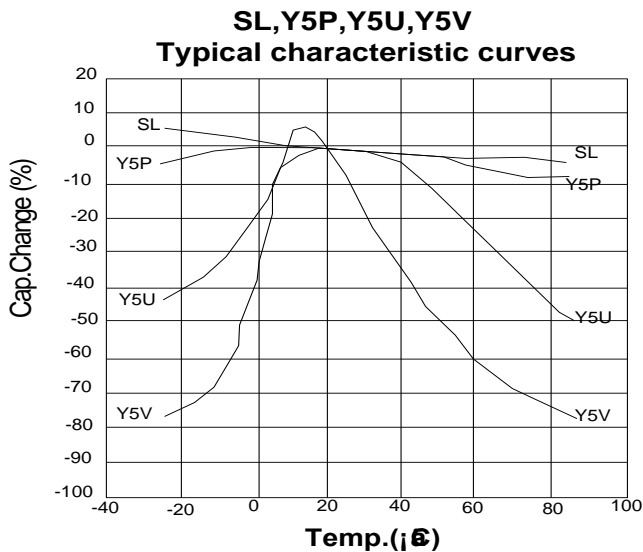

Note: Above data are just for reference not assured one:

Leakage current characteristics (Type X1 Y2: 0~2600Vac):

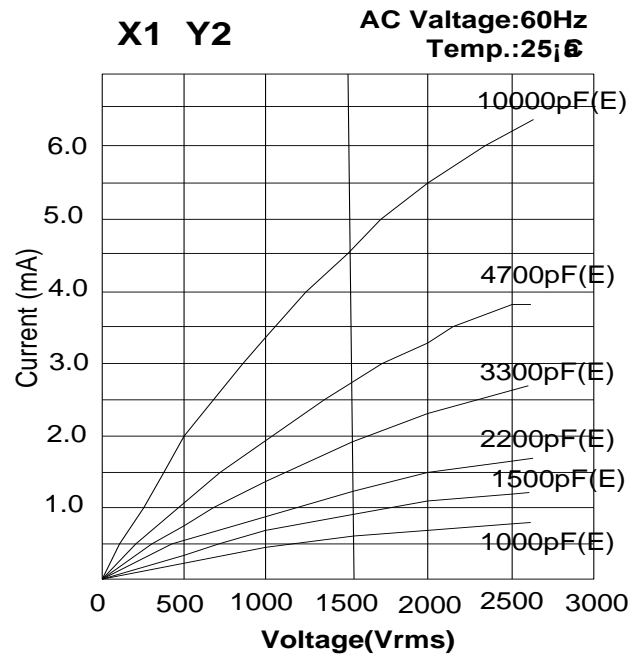
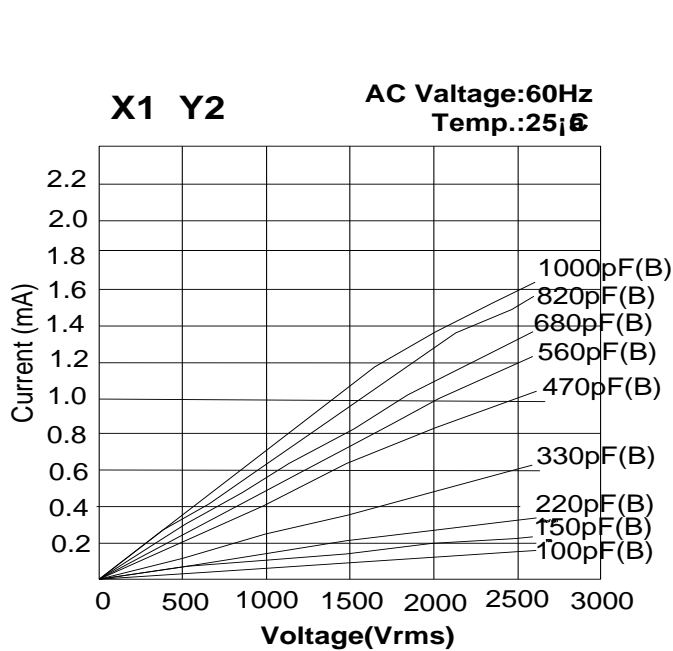

Note: Above data are just for reference not assured ones.

# CCD Series

## Safety Standard Recognized Ceramic Capacitors

**TRIGON**  
COMPONENTS

### Packing Information

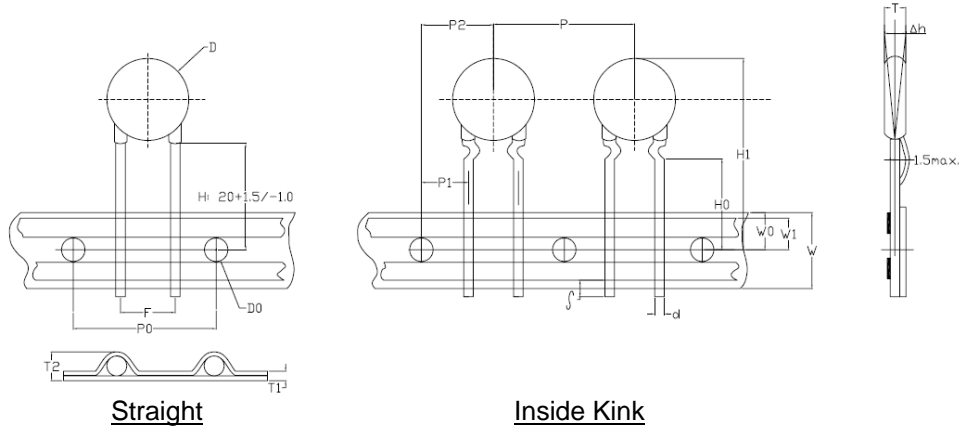

Item	Symbol	Specification (mm)				
		5T1/5R1	7T1/7R1	7T5/7R5	0T2/0R2	Tolerance
Pitch of component	P	12.7	12.7	15	25.4	
Feed hole pitch	P0	12.7	12.7	15	12.7	+/-0.3
Lead to lead distance	F	5+0.8/-0.2	7.5±1.0	7.5±1.0	10±1.0	
Feed hole center to lead	P1	3.85	8.95	3.75	7.62	+/-0.7
Hold center to component center	P2	6.35	-	-	-	+/-1.3
Body diameter	D	11Max.	11Max.	11<D≤16	16Max.	Max.
Body thickness	T	5.0	8			Max.
Lead-wire diameter	D	0.6	0.6+1/-0.5			
Component alignment F-R	Δh	0				+/-2.0
Tape width	W	18.0				+1.0/0.5
Hold-down tape width	W0	5.0				Min.
Hold position	W1	9.0				+/-0.5
Hold-down tape position	W2	3.0				Max.
Height of component from tape center	H	20.0				+1.5/-1.0
Lead wire clinch	H0	16.0				+/-0.5
Component height	H1	32.25	37			Max.
Lead wire protrusion	f	1.0				Max.
Feed hole diameter	D0	4.0				+/-0.2
Total tape thickness	T1	0.6				+/-0.3
Maximum thickness of tape and wire	T2	1.5				Max.

### Bulk

Capacitance	Notes	Bag	Box
3300pF max		200pcs	200*10
3900pF~10000pF	Lead length≥24mm	100pcs	100*10
	Lead length<24mm	200pcs	200*10

### Taping

Pitch	D(max)	P	Reel	Ammo
5	8	12.7	1500*2	1000
	8<D≤11	12.7	1000*2	1000
7.5	≤8	12.7	1500*2	1000
	9≤D≤11	12.7	1500*2	1000
	>11	15.0	1500*2	1000
10	8≤D≤16	25.4	500*2	500
12.5	8≤D≤16	25.4	300*2	300

# CCD Series

Safety Standard Recognized Ceramic Capacitors

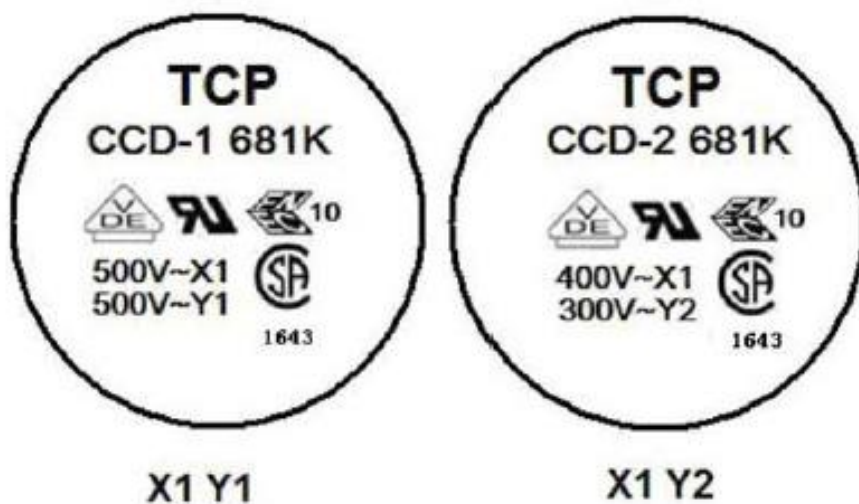

TRIGON  
COMPONENTS

## Marking Example



Capacitor

## Label Example

TRIGON	
CP/No: *****	RoHS Compliant
	
P/No: CCD- *****	
	
Description:	LOT NO: XXXXXXXX
<b>Safety Standard Capacitors *****</b>	
Q/ty: ***** PCS	D/C:*****
	D/O: PO*****
Made in China	

## Shipping

Capacitors shall be packaged prior to shipment so as to prevent damage during transportation and storage. Shipping carton contains the following information on the label.

# CCD Series

## Safety Standard Recognized Ceramic Capacitors

**TRIGON**  
COMPONENTS

### Specification and Testing Method

Item		Specification	Testing Method																										
1	Dielectric Strength Between lead wires	No failure	The capacitors shall not be damage when test voltage of Table 1 are applied between the lead wires for 60 sec. (charge / discharge $\leq$ 50mA)  Table 1 <table border="1"> <thead> <tr> <th>Type</th> <th>Test Voltage</th> </tr> </thead> <tbody> <tr> <td>CCD-1</td> <td>4000VAC</td> </tr> <tr> <td>CCD-2</td> <td>2600VAC</td> </tr> </tbody> </table>	Type	Test Voltage	CCD-1	4000VAC	CCD-2	2600VAC																				
	Type	Test Voltage																											
CCD-1	4000VAC																												
CCD-2	2600VAC																												
	Body insulation	No failure	First, The terminals of the capacitor shall be connected together. Then, as show in the figure to the right, a metal foil shall be closely wrapped around the body of the capacitor to the distance of about 3 to 4mm from each terminal. Then, the capacitor shall be inserted into a container filled with metal balls of about 1mm diameter. Finally AC voltage of Table 1 is applied for 60sec. Between the capacitor lead wires and metal balls. (charge / discharge $\leq$ 50mA)																										
2	Insulation Resistance (I.R.)	10000Mohms min.	The insulation resistance shall be measure with 500 $\pm$ 50VDC within 60 $\pm$ 5sec. of charging.																										
3	Capacitance	Within specified tolerance.	The capacitance shall be measured at 25°C with 1 $\pm$ 0.1KHz and 5Vrms max.(COG with 1MHz $\pm$ 20% 1Vrms)																										
4	Dissipation Factor (D.F.) Quality Factor (Q)	<table border="1"> <thead> <tr> <th>Char.</th> <th>Spec.</th> </tr> </thead> <tbody> <tr> <td>B,E</td> <td>D.F.<math>\leq</math>2.5%</td> </tr> <tr> <td>F</td> <td>D.F.<math>\leq</math>5.0%</td> </tr> <tr> <td>COG</td> <td>Q<math>\geq</math>300</td> </tr> </tbody> </table>	Char.	Spec.	B,E	D.F. $\leq$ 2.5%	F	D.F. $\leq$ 5.0%	COG	Q $\geq$ 300	The dissipation factor shall be measured at 25°C with 1 $\pm$ 0.1KHz and 5Vrms max.(COG with 1MHz $\pm$ 20% 1Vrms)																		
Char.	Spec.																												
B,E	D.F. $\leq$ 2.5%																												
F	D.F. $\leq$ 5.0%																												
COG	Q $\geq$ 300																												
5	Temperature Characteristic	<table border="1"> <thead> <tr> <th>Char.</th> <th>Cap.Change</th> </tr> </thead> <tbody> <tr> <td>B</td> <td><math>\pm</math>10%</td> </tr> <tr> <td>E</td> <td>-56%~+22%</td> </tr> <tr> <td>F</td> <td>-82%~+22%</td> </tr> <tr> <td>R</td> <td><math>\pm</math>15%</td> </tr> <tr> <td>S</td> <td>-1000~+350ppm/°C</td> </tr> <tr> <td>COG</td> <td>0<math>\pm</math>60ppm/°C</td> </tr> </tbody> </table>	Char.	Cap.Change	B	$\pm$ 10%	E	-56%~+22%	F	-82%~+22%	R	$\pm$ 15%	S	-1000~+350ppm/°C	COG	0 $\pm$ 60ppm/°C	The capacitance measurement shall be made at each step specified in table 2.  Table 1 <table border="1"> <thead> <tr> <th>Step</th> <th>Temperature(°C)</th> </tr> </thead> <tbody> <tr> <td>1</td> <td>+25<math>\pm</math>2</td> </tr> <tr> <td>2</td> <td>-25<math>\pm</math>2(JR: -55<math>\pm</math>2)</td> </tr> <tr> <td>3</td> <td>+25<math>\pm</math>2</td> </tr> <tr> <td>4</td> <td>-85<math>\pm</math>2(JR: -125<math>\pm</math>2)</td> </tr> <tr> <td>5</td> <td>+20<math>\pm</math>2</td> </tr> </tbody> </table>	Step	Temperature(°C)	1	+25 $\pm$ 2	2	-25 $\pm$ 2(JR: -55 $\pm$ 2)	3	+25 $\pm$ 2	4	-85 $\pm$ 2(JR: -125 $\pm$ 2)	5	+20 $\pm$ 2
		Char.	Cap.Change																										
B	$\pm$ 10%																												
E	-56%~+22%																												
F	-82%~+22%																												
R	$\pm$ 15%																												
S	-1000~+350ppm/°C																												
COG	0 $\pm$ 60ppm/°C																												
Step	Temperature(°C)																												
1	+25 $\pm$ 2																												
2	-25 $\pm$ 2(JR: -55 $\pm$ 2)																												
3	+25 $\pm$ 2																												
4	-85 $\pm$ 2(JR: -125 $\pm$ 2)																												
5	+20 $\pm$ 2																												
			Pre-treatment: Capacitor shall be stored at 85 $\pm$ 2°C(JR: 125 $\pm$ 2) for 1 hour. Then placed at room condition for (*)24 $\pm$ 2 hours before measurements.																										
6	Robustness of Termination	Tensile Lead wire shall not cut off. Capacitor shall not be broken.	With the termination in its normal position. The specimen is held by its body in such a manner that the axis of the terminations is vertical the tensile force of 10N shall be applied to termination in the direction of its axis and acting in direction from the body of the specimen.																										
		Bending Lead wire shall not cut off. Capacitor shall not be broken.	With the termination in its normal position. The specimen is held by its body in such a manner that the axis of the terminations is vertical; a mass applying a force of 5N is then suspended from the end of the termination. The body of the specimen is then inclined within a period of 2 to 3 sec., through an angle of a approximately 90 in the vertical plane and then returned to its initial position over the same period of time; this operation constitutes one bend. One bend immediately followed by a second in the opposite direction.																										

\* "room condition" temperature: 15~35°C, humidity: 45~75%, atmospheric: 86~106kPa



# CCD Series

## Safety Standard Recognized Ceramic Capacitors

**TRIGON**  
COMPONENTS

Capacitor

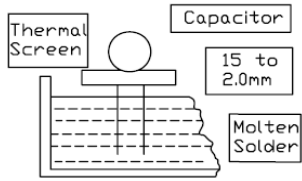
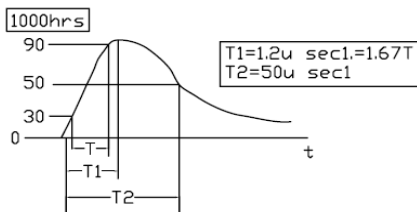
Item		Specification	Testing Method
7	Soldering Effect	Appearance	No marked defect.
		I.R.	1000M ohms min.
		Dielectric Strength	Per Item 1.
		Capacitance	Within $\pm 10\%$
			<p>Solder temperature: <math>350\pm 10^{\circ}\text{C}</math> of <math>260\pm 5^{\circ}\text{C}</math>            Immersion time: <math>3.5\pm 0.5\text{sec.}</math>            (<math>10\pm 1\text{sec.}</math> for <math>260\pm 5^{\circ}\text{C}</math>)            The depth of immersion shall be a position <math>2+0/-0.5\text{mm}</math> from the seating plane. Using a thermal insulating screen of <math>1.5\pm 0.5\text{mm}</math> thickness.</p>  <p>Pre-treatment:            Capacitor shall be stored at <math>85\pm 2^{\circ}\text{C}</math> for 1 hour, then placed at room condition for <math>(*)24\pm 2</math> hours before initial measurements.</p> <p>Post-treatment:            Capacitor shall be store for 1 to 2 hours at room condition.</p>
8	Humidity (Under Steady State)	Appearance	No marked defect.
		Capacitance Change	B: Within 10%, R: 15% E,F: Within 15%,30%,C: 5%
		D.F.	B,E,R: D.F. $\leq 5.0\%$ F: D.F. $\leq 7.5\%$ , C: Q $\geq 135$
		I.R.	3000M ohms min.
		Dielectric Strength	Per Item 1.
			<p>Set the capacitor for <math>500\pm 12</math> hours at <math>40\pm 2^{\circ}\text{C}</math>, in 90 to 95% humidity.</p> <p>Pre-treatment:            Capacitor shall be stored at <math>85\pm 2^{\circ}\text{C}</math> for 1 hour, then placed at room condition for <math>(*)24\pm 2</math> hours before initial measurements.</p> <p>Post-treatment:            Capacitor shall be store for 1 to 2 hours at room condition.</p>
9	Humidity Loading	Appearance	No marked defect.
		Capacitance Change	B: Within 10%, R: 15% E,F: Within 15%,30%,C: 5%
		D.F.	B,E,R: D.F. $\leq 5.0\%$ F: D.F. $\leq 7.5\%$ , C: Q $\geq 135$
		I.R.	3000M ohms min.
		Dielectric Strength	Per Item 1.
			<p>Apply the rate voltage for <math>500\pm 12</math> hours at <math>40\pm 2^{\circ}\text{C}</math>, in 90 to 95% humidity.</p> <p>Pre-treatment:            Capacitor shall be stored at <math>85\pm 2^{\circ}\text{C}</math> for 1 hour, then placed at room condition for <math>(*)24\pm 2</math> hours before initial measurements.</p> <p>Post-treatment:            Capacitor shall be store for 1 to 2 hours at room condition.</p>
10	Life	Appearance	No marked defect.
		Capacitance Change	B: Within 10%, R: 15% E,F: Within 15%,30%,C: 5%
		I.R.	3000M ohms min.
		Dielectric Strength	Per Item 1.
		Discharge Test(II)	No failure
			<p>Impulse Voltage</p> <p>Each individual capacitor shall be subjected to a 5KV(JN type: 8KV) impulses for three times. After the capacitors are applied to life test.</p>  <p>The specimen capacitors are placed in a circulating air oven a period of 1000 hours. The air in the oven is maintained at a temperature of <math>125\pm 2^{\circ}\text{C}</math>. Throughout the test. The capacitors are subjected to a <math>425\text{Vrms}</math> alternating voltage of mains frequency. Except that once each hour the voltage is increased to <math>1000\text{Vrms}</math> for 0.1 sec.</p>

\* "room condition" temperature:  $15\sim 35^{\circ}\text{C}$ , humidity:  $45\sim 75\%$ , atmospheric:  $86\sim 106\text{kPa}$

# CCD Series

## Safety Standard Recognized Ceramic Capacitors

**TRIGON**  
COMPONENTS

Capacitor

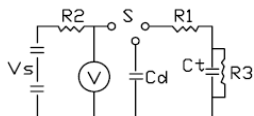
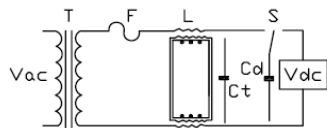
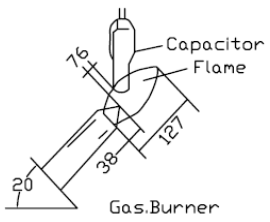
Item		Specification	Testing Method									
11	Discharge Test (I)	Appearance	No marked defect.									
		I.R.	1000M ohms min.									
		Dielectric Strength	Per Item 1.									
			<p>As in Figure 1, discharge is made 50 times at 5 sec. intervals from the capacitor (Cd) charged DC voltage of specified.</p>  <p>(Figure 1)</p> <p>Ct: Capacitor under test Cd: 0.001uF S1: High-voltage switch R1: 1000 ohms R2: 100M ohms R3: Surge resistance Vs: 10KVDC</p>									
12	Discharge Test (II)	The cheesecloth around capacitors shall not glow or flame	<p>A single layer cheesecloth is to be placed around the body of the test capacitor. Each sample is to be subjected to four discharges from a dump capacitor charged to a voltage that when discharged placed DC5KV across the capacitor under test. The interval between successive discharges is to be 5 sec. AC240V, 60Hz potential is to be applied across the capacitor under test and is to be maintained for 30 sec. after the fourth discharge. Unless the circuit is opened in a shorter time by breakdown of the test capacitor. The direct current supply is to be adjusted to provide a potential in accordance with the following.</p> $V_{dc} = \frac{5000(C_d - C_t)}{C_d} \text{ (V)}$  <p>(Figure 2)</p> <p>Vdc: Variable direct-current voltage source S: High-voltage switch L: Choke coil of approximately 3mH and 0.03 ohm F: Plug fuse rated 30A and 250V Vac: Supply source rated 240V, 60Hz and 30A Ct: Capacitor under test Cd: Dump capacitor</p> <p>Capacitance value and D.F. are as follows:</p> <table border="1"> <tr> <td>Cap.Value of Ct</td> <td>0 to 0.005uF</td> <td>0.0051 to 0.05uF</td> </tr> <tr> <td>Cap.Value of Cd</td> <td>0.005uF</td> <td>0.005uF</td> </tr> <tr> <td>D.F. of Cd</td> <td>0.5% max.</td> <td>0.5% max.</td> </tr> </table>	Cap.Value of Ct	0 to 0.005uF	0.0051 to 0.05uF	Cap.Value of Cd	0.005uF	0.005uF	D.F. of Cd	0.5% max.	0.5% max.
Cap.Value of Ct	0 to 0.005uF	0.0051 to 0.05uF										
Cap.Value of Cd	0.005uF	0.005uF										
D.F. of Cd	0.5% max.	0.5% max.										
13	Flame Test	<p>The capacitor flame discontinue as follows:</p> <table border="1"> <tr> <th>Cycle</th> <th>Cycle</th> </tr> <tr> <td>1 to 4</td> <td>30 sec. max.</td> </tr> <tr> <td>5</td> <td>60 sec. max.</td> </tr> </table>	Cycle	Cycle	1 to 4	30 sec. max.	5	60 sec. max.	<p>The capacitor shall be subjected to applied for 15 sec. and then removed for 15 sec. until 5 cycle.</p> 			
Cycle	Cycle											
1 to 4	30 sec. max.											
5	60 sec. max.											

# CCD Series

## Safety Standard Recognized Ceramic Capacitors

**TRIGON**  
COMPONENTS

Capacitor

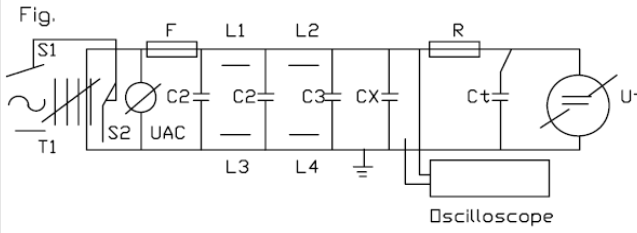
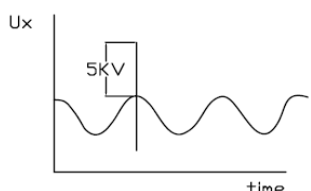
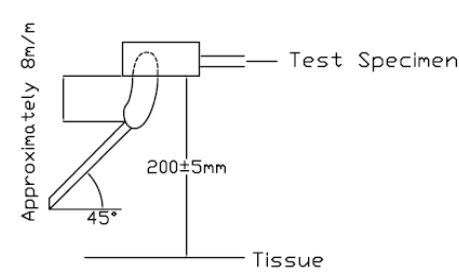
Item	Specification	Testing Method
14	Active Flammability The cheesecloth shall not be on fire.	<p>The specimens shall be individually wrapped in least one but more than two complete layers of cheese-cloth. The specimens shall be subjected to 20 discharges. The interval between successive discharges shall be 5 sec. The <math>U_{ac}</math> shall be maintained for 2 min. after the last discharge.</p> <p>Fig.</p>  <p> <math>C_{1,2}</math>: 1<math>\mu</math>F  <math>C_3</math>: 0.33<math>\mu</math>F<math>\pm</math>5% 10KV  <math>C_t</math>: 3<math>\mu</math>F<math>\pm</math>5% 10KV  <math>C_x</math>: Capacitor  <math>F</math>: Fuse, Rated 10A  <math>U_t</math>: Voltage applied to <math>C_t</math> </p> <p> <math>L_1</math> to <math>L_4</math>: 1.5mH<math>\pm</math>20%  16A Rod core choke  <math>R</math>: 100ohms<math>\pm</math>2%  <math>U_{ac}</math>: <math>U_r</math><math>\pm</math>5%  <math>U_r</math>: Rated Working Voltage </p> 
15	Passive Flameability The burning time shall not be exceeded the time 30 sec. The tissue paper shall not ignite.	<p>The capacitor under test shall be held in the flame in the position, which best promotes burning. Each specimen shall only be exposed one to the flame. Time of exposure to flame: 30 sec.</p> <p>Length of flame: 12<math>\pm</math>1mm  Gasburner: Length 35mm min.  Inside Diameter: 0.5<math>\pm</math>0.1mm  Outside Diameter: 0.9mm max.  Gas: Butane gas Purity 95% min.</p> 

# SOLDERING PROFILE

Safety Standard Recognized Ceramic Capacitors

TRIGON  
COMPONENTS

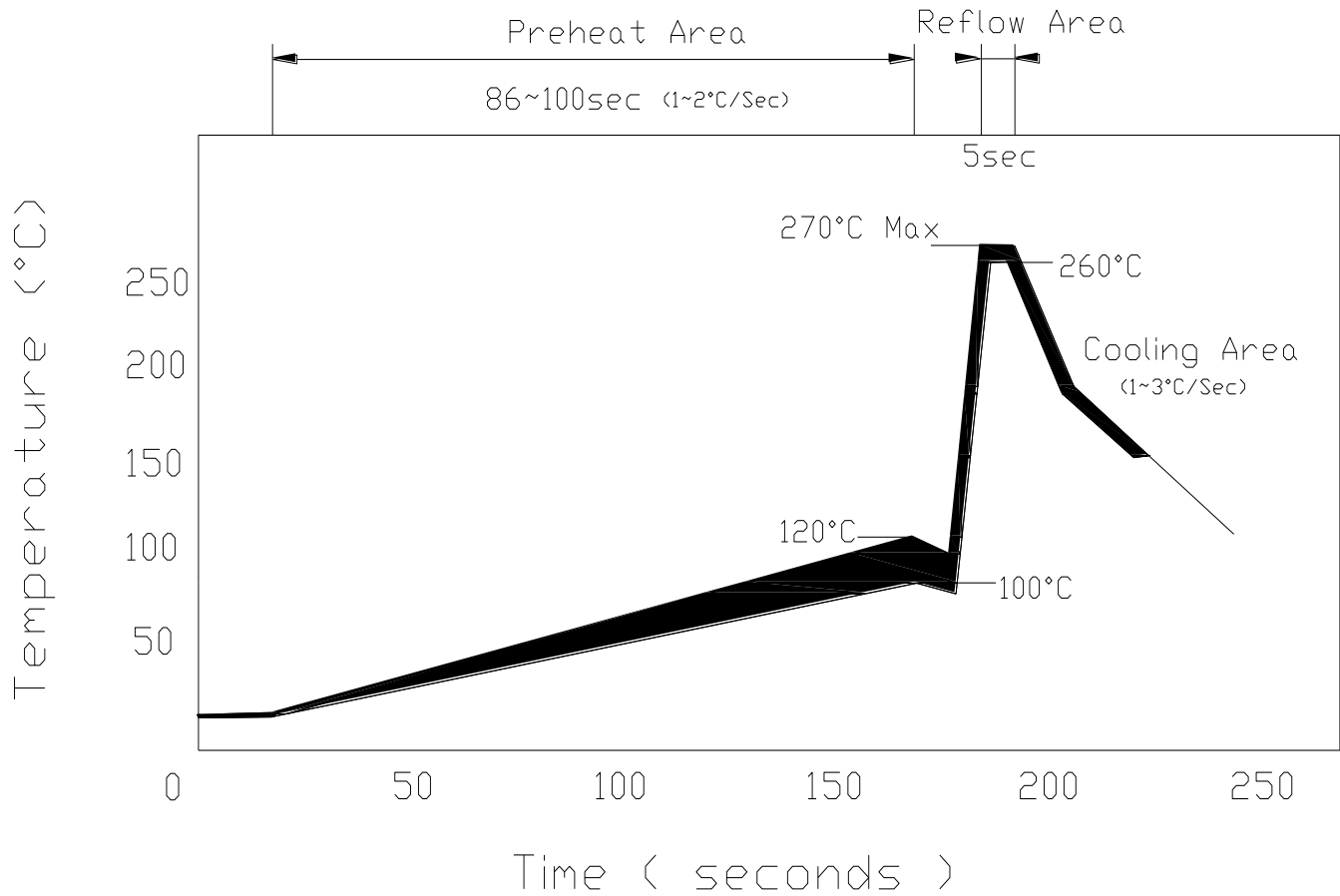

(Pb-Free Assembly)

Capacitor