

**Data sheet | Item number: 2002-2237**

Double-deck terminal block; 4-conductor ground terminal block; 2.5 mm<sup>2</sup>; PE; suitable for Ex e II applications; with marker carrier; internal commoning; for DIN-rail 35 x 15 and 35 x 7.5; Push-in CAGE CLAMP®; 2,50 mm<sup>2</sup>; green-yellow

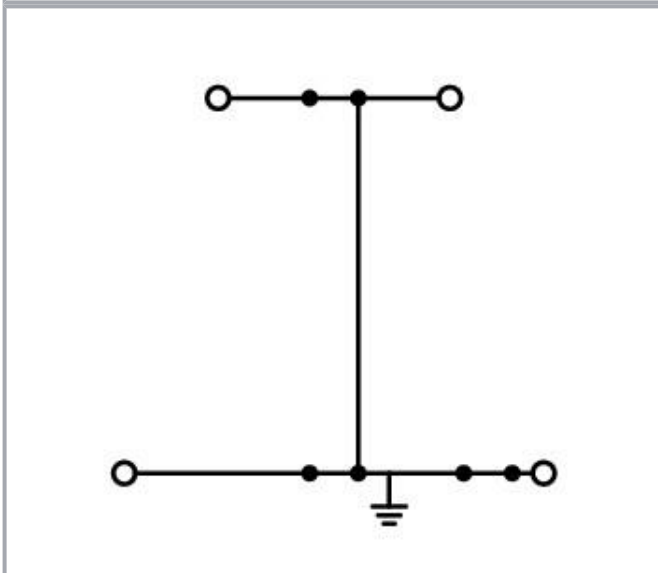

[www.wago.com/2002-2237](http://www.wago.com/2002-2237)

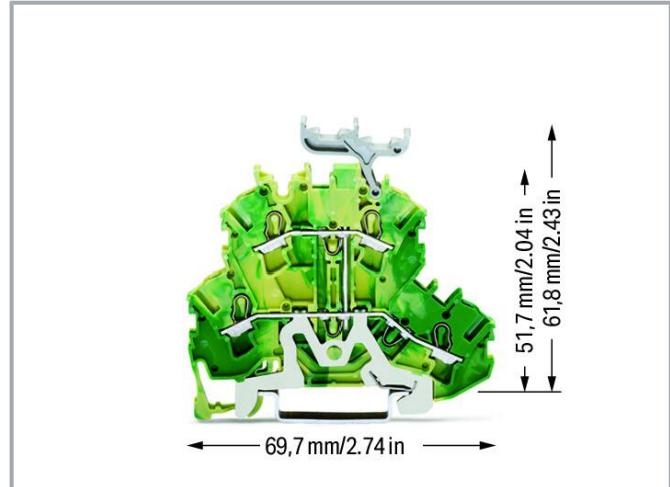

Subject to changes. Please also observe the further product documentation!

WAGO GmbH & Co. KG  
Hansastr. 27  
32423 Minden  
Phone: +49571 887-0 | Fax: +49571 887-169  
Email: [info.de@wago.com](mailto:info.de@wago.com) | Web: [www.wago.com](http://www.wago.com)

Do you have any questions about our products?  
We are always happy to take your call at +49 (571) 887-44222.



## Data

### Electrical data

#### Ratings per IEC/EN

Ratings per	IEC/EN 60947-7-2
-------------	------------------

#### Ex information

Reference hazardous areas	See "Downloads – Documentation – Additional Information: Technical Section; Technical Explications"
Ratings per	ATEX: PTB 03 ATEX 1162 U / IECEx: PTB 03.0004U (Ex eb IIC Gb)

#### Connection data

Connection points	4
Total number of potentials	1
Number of levels	2
Number of jumper slots	3
Anzahl Brückeraufnahmen Rang	2

#### Connection 1

Connection technology	Push-in CAGE CLAMP®
Actuation type	Operating tool
Connectable conductor materials	Copper
Nominal cross-section	2.5 mm <sup>2</sup>
Solid conductor	0.25 ... 4 mm <sup>2</sup> / 22 ... 12 AWG
Solid conductor; push-in termination	0.75 ... 4 mm <sup>2</sup> / 18 ... 12 AWG
Fine-stranded conductor	0.25 ... 4 mm <sup>2</sup> / 22 ... 12 AWG
Fine-stranded conductor; with insulated ferrule	0.25 ... 2.5 mm <sup>2</sup> / 22 ... 14 AWG
Fine-stranded conductor; with ferrule; push-in termination	1 ... 2.5 mm <sup>2</sup> / 18 ... 14 AWG
Note (conductor cross-section)	Depending on the conductor characteristic, a conductor with a smaller cross-section can also be inserted via push-in termination.
Strip length	10 ... 12 mm / 0.39 ... 0.47 inches
Wiring direction	Front-entry wiring

#### Physical data

Width	5.2 mm / 0.205 inches
Height	69.7 mm / 2.744 inches

Subject to changes. Please also observe the further product documentation!



Depth from upper-edge of DIN-rail	61.8 mm / 2.433 inches
-----------------------------------	------------------------

### Mechanical Data

Potential marking	PE
Mounting type	DIN-35 rail
Marking level	Center/side marking

### Material Data

Note (material data)	Information on material specifications can be found <a href="#">here</a>
----------------------	--

Color	green-yellow
Material group	I
Insulation material	Polyamide (PA66)
Flammability class per UL94	V0
Fire load	0.226 MJ
Weight	14 g

### Environmental requirements

Processing temperature	-35 ... +85 °C
Continuous operating temperature	-60 ... +105 °C

### Commercial data

Product Group	22 (TOPJOB S)
eCl@ss 10.0	27-14-11-41
eCl@ss 9.0	27-14-11-41
ETIM 8.0	EC000901
ETIM 7.0	EC000901
PU (SPU)	50 pcs
Packaging type	box
Country of origin	DE
GTIN	4044918989763
Customs tariff number	85369010000





### Environmental Product Compliance

RoHS Compliance Status	Compliant, No Exemption
------------------------	-------------------------

Subject to changes. Please also observe the further product documentation!

## Approvals / Certificates

### General approvals

Logo	Approval	Additional Approval Text	Certificate name
	CCA DEKRA Certification B.V.	EN 60947	71-120369
	CCA DEKRA Certification B.V.	EN 60947	NTR NL 7892
	CCC CNEX	GB/T 3836.3	2020312313000238 (Ex eb IIC Gb, Ex eb I Mb)
	CSA DEKRA Certification B.V.	C22.2 No. 158	1536069
	UL Underwriters Laboratories Inc.	UL 1059	E45172

### Declarations of conformity and manufacturer's declarations

Logo	Approval	Additional Approval Text	Certificate name
	EU-Declaration of Conformity WAGO GmbH & Co. KG	-	-
	Railway WAGO GmbH & Co. KG	-	Railway Ready
	UK-Declaration of Conformity WAGO GmbH & Co. KG	-	-

### Approvals for marine applications

Logo	Approval	Additional Approval Text	Certificate name

Subject to changes. Please also observe the further product documentation!

WAGO GmbH & Co. KG  
Hansastr. 27  
32423 Minden  
Phone: +49571 887-0 | Fax: +49571 887-169  
Email: [info.de@wago.com](mailto:info.de@wago.com) | Web: [www.wago.com](http://www.wago.com)

Do you have any questions about our products?  
We are always happy to take your call at +49 (571) 887-44222.



**ABS**  
American Bureau of Shipping

EN 60947

20-  
HG1941090-  
PDA







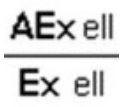

**DNV GL**  
Det Norske Veritas, Germanischer Lloyd

-

TAE00001V2

**Approvals for hazardous areas**

Logo	Approval	Additional Approval Text	Certificate name
	<b>AEx</b> Underwriters Laboratories Inc.	UL 60079	E185892 (AEx eb IIC resp. Ex eb IIC)
	<b>ATEX</b> Physikalisch Technische Bundesanstalt (PTB)	EN 60079	PTB 03 ATEX 1162 U (II2G Ex eb IIC Gb, IM2 Ex eb IMb)
	<b>CCC</b> CNEX	GB/T 3836.3	2020312313000238 (Ex eb IIC Gb, Ex eb I Mb)
	<b>EAC</b> Brjansker Zertifizierungsstelle	TP TC 012/2011	RU C-DE.AM02.B.00127/19 (Ex e IIC Gb U)
	<b>IECEX</b> Physikalisch Technische Bundesanstalt	IEC 60079	IECEX PTB 03.0004U (Ex eb IIC Gb or Ex eb I Mb)
	<b>INMETRO</b> TÜV Rheinland do Brasil Ltda.	IEC 60079	TÜV 12.1307 U

**Required accessories**

**End plate**

End plate



**Item no.: 2002-2291**  
End and intermediate plate; 0.8 mm thick; gray

[www.wago.com/2002-2291](http://www.wago.com/2002-2291)

Subject to changes. Please also observe the further product documentation!

**Item no.: 2002-2292**

End and intermediate plate; 0.8 mm thick; orange

[www.wago.com/2002-2292](http://www.wago.com/2002-2292)

## Optional accessories

### End plate

End plate









**Item no.: 209-192**

Separator for Ex e/Ex i applications; 3 mm thick; 125.5 mm wide; orange

[www.wago.com/209-192](http://www.wago.com/209-192)

### Ferrule

Ferrule

	<b>Item no.: 216-241</b> Ferrule; Sleeve for 0.5 mm <sup>2</sup> / 20 AWG; insulated; electro-tin plated; electrolytic copper; gastight crimped; acc. to DIN 46228, Part 4/09.90; white	<a href="http://www.wago.com/216-241">www.wago.com/216-241</a>
	<b>Item no.: 216-242</b> Ferrule; Sleeve for 0.75 mm <sup>2</sup> / 18 AWG; insulated; electro-tin plated; electrolytic copper; gastight crimped; acc. to DIN 46228, Part 4/09.90; gray	<a href="http://www.wago.com/216-242">www.wago.com/216-242</a>
	<b>Item no.: 216-243</b> Ferrule; Sleeve for 1 mm <sup>2</sup> / AWG 18; insulated; electro-tin plated; electrolytic copper; gastight crimped; acc. to DIN 46228, Part 4/09.90; red	<a href="http://www.wago.com/216-243">www.wago.com/216-243</a>
	<b>Item no.: 216-244</b> Ferrule; Sleeve for 1.5 mm <sup>2</sup> / AWG 16; insulated; electro-tin plated; electrolytic copper; gastight crimped; acc. to DIN 46228, Part 4/09.90; black	<a href="http://www.wago.com/216-244">www.wago.com/216-244</a>
	<b>Item no.: 216-263</b> Ferrule; Sleeve for 1 mm <sup>2</sup> / AWG 18; insulated; electro-tin plated; electrolytic copper; gastight crimped; acc. to DIN 46228, Part 4/09.90; red	<a href="http://www.wago.com/216-263">www.wago.com/216-263</a>
	<b>Item no.: 216-246</b> Ferrule; Sleeve for 2.5 mm <sup>2</sup> / AWG 14; insulated; electro-tin plated; electrolytic copper; gastight crimped; acc. to DIN 46228, Part 4/09.90; blue	<a href="http://www.wago.com/216-246">www.wago.com/216-246</a>
	<b>Item no.: 216-266</b> Ferrule; Sleeve for 2.5 mm <sup>2</sup> / AWG 14; insulated; electro-tin plated; electrolytic copper; gastight crimped; acc. to DIN 46228, Part 4/09.90; blue	<a href="http://www.wago.com/216-266">www.wago.com/216-266</a>
	<b>Item no.: 216-264</b> Ferrule; Sleeve for 1.5 mm <sup>2</sup> / AWG 16; insulated; electro-tin plated; electrolytic copper; gastight crimped; acc. to DIN 46228, Part 4/09.90; black	<a href="http://www.wago.com/216-264">www.wago.com/216-264</a>
	<b>Item no.: 216-262</b> Ferrule; Sleeve for 0.75 mm <sup>2</sup> / 18 AWG; insulated; electro-tin plated; electrolytic copper; gastight crimped; acc. to DIN 46228, Part 4/09.90; gray	<a href="http://www.wago.com/216-262">www.wago.com/216-262</a>

### Insulation stop

Insulation stop

**Item no.: 2002-171**Insulation stop; 0.25 - 0.5 mm<sup>2</sup>; 5 pieces/strip; light gray[www.wago.com/2002-171](http://www.wago.com/2002-171)

Subject to changes. Please also observe the further product documentation!

WAGO GmbH &amp; Co. KG

Hansastr. 27

32423 Minden

Phone: +49571 887-0 | Fax: +49571 887-169

Email: [info.de@wago.com](mailto:info.de@wago.com) | Web: [www.wago.com](http://www.wago.com)

Do you have any questions about our products?

We are always happy to take your call at +49 (571) 887-44222.



**Item no.: 2002-172**  
Insulation stop; 0.75 - 1 mm<sup>2</sup>; 5 pieces/strip; dark gray

[www.wago.com/2002-172](http://www.wago.com/2002-172)

**Marking accessories**

Marking strip



**Item no.: 2009-110**  
Marking strips; for Smart Printer; on reel; not stretchable; plain; snap-on type; white

[www.wago.com/2009-110](http://www.wago.com/2009-110)

Marker carrier



**Item no.: 2009-198**  
Adaptor; gray

[www.wago.com/2009-198](http://www.wago.com/2009-198)

Marker



**Item no.: 2009-115/000-002**  
WMB-Inline; for Smart Printer; 1500 pieces on roll; stretchable 5 - 5.2 mm; plain; snap-on type; yellow

[www.wago.com/2009-115/000-002](http://www.wago.com/2009-115/000-002)



**Item no.: 2009-115/000-007**  
WMB-Inline; for Smart Printer; 1500 pieces on roll; stretchable 5 - 5.2 mm; plain; snap-on type; gray

[www.wago.com/2009-115/000-007](http://www.wago.com/2009-115/000-007)



**Item no.: 2009-115/000-017**  
WMB-Inline; for Smart Printer; 1500 pieces on roll; stretchable 5 - 5.2 mm; plain; snap-on type; light green

[www.wago.com/2009-115/000-017](http://www.wago.com/2009-115/000-017)



**Item no.: 2009-115/000-023**  
WMB-Inline; for Smart Printer; 1500 pieces on roll; stretchable 5 - 5.2 mm; plain; snap-on type; green

[www.wago.com/2009-115/000-023](http://www.wago.com/2009-115/000-023)



**Item no.: 2009-115/000-024**  
WMB-Inline; for Smart Printer; 1500 pieces on roll; stretchable 5 - 5.2 mm; plain; snap-on type; violet

[www.wago.com/2009-115/000-024](http://www.wago.com/2009-115/000-024)



**Item no.: 2009-145/000-006**  
Mini-WSB Inline; for Smart Printer; 1700 pieces on roll; stretchable 5 - 5.2 mm; plain; snap-on type; blue

[www.wago.com/2009-145/000-006](http://www.wago.com/2009-145/000-006)



**Item no.: 2009-145**  
Mini-WSB Inline; for Smart Printer; 1700 pieces on roll; stretchable 5 - 5.2 mm; plain; snap-on type; white

[www.wago.com/2009-145](http://www.wago.com/2009-145)



**Item no.: 2009-145/000-002**  
Mini-WSB Inline; for Smart Printer; 1700 pieces on roll; stretchable 5 - 5.2 mm; plain; snap-on type; yellow













[www.wago.com/2009-145/000-002](http://www.wago.com/2009-145/000-002)



**Item no.: 2009-145/000-007**  
Mini-WSB Inline; for Smart Printer; 1700 pieces on roll; stretchable 5 - 5.2 mm; plain; snap-on type; gray

[www.wago.com/2009-145/000-007](http://www.wago.com/2009-145/000-007)

Subject to changes. Please also observe the further product documentation!

	<p><b>Item no.: 2009-145/000-005</b>                  Mini-WSB Inline; for Smart Printer; 1700 pieces on roll; stretchable 5 - 5.2 mm; plain; snap-on type; red</p>	<a href="http://www.wago.com/2009-145/000-005">www.wago.com/2009-145/000-005</a>
	<p><b>Item no.: 2009-145/000-012</b>                  Mini-WSB Inline; for Smart Printer; 1700 pieces on roll; stretchable 5 - 5.2 mm; plain; snap-on type; orange</p>	<a href="http://www.wago.com/2009-145/000-012">www.wago.com/2009-145/000-012</a>
	<p><b>Item no.: 2009-145/000-023</b>                  Mini-WSB Inline; for Smart Printer; 1700 pieces on roll; stretchable 5 - 5.2 mm; plain; snap-on type; green</p>	<a href="http://www.wago.com/2009-145/000-023">www.wago.com/2009-145/000-023</a>
	<p><b>Item no.: 2009-145/000-024</b>                  Mini-WSB Inline; for Smart Printer; 1700 pieces on roll; stretchable 5 - 5.2 mm; plain; snap-on type; violet</p>	<a href="http://www.wago.com/2009-145/000-024">www.wago.com/2009-145/000-024</a>
	<p><b>Item no.: 2009-115</b>                  WMB-Inline; for Smart Printer; 1500 pieces on roll; stretchable 5 - 5.2 mm; plain; snap-on type; white</p>	<a href="http://www.wago.com/2009-115">www.wago.com/2009-115</a>
	<p><b>Item no.: 248-501/000-006</b>                  Mini-WSB marking card; as card; not stretchable; plain; snap-on type; blue</p>	<a href="http://www.wago.com/248-501/000-006">www.wago.com/248-501/000-006</a>
	<p><b>Item no.: 248-501/000-007</b>                  Mini-WSB marking card; as card; not stretchable; plain; snap-on type; gray</p>	<a href="http://www.wago.com/248-501/000-007">www.wago.com/248-501/000-007</a>
	<p><b>Item no.: 248-501/000-002</b>                  Mini-WSB marking card; as card; not stretchable; plain; snap-on type; yellow</p>	<a href="http://www.wago.com/248-501/000-002">www.wago.com/248-501/000-002</a>
	<p><b>Item no.: 248-501/000-012</b>                  Mini-WSB marking card; as card; not stretchable; plain; snap-on type; orange</p>	<a href="http://www.wago.com/248-501/000-012">www.wago.com/248-501/000-012</a>
	<p><b>Item no.: 248-501</b>                  Mini-WSB marking card; as card; not stretchable; plain; snap-on type; white</p>	<a href="http://www.wago.com/248-501">www.wago.com/248-501</a>
	<p><b>Item no.: 248-501/000-017</b>                  Mini-WSB marking card; as card; not stretchable; plain; snap-on type; light green</p>	<a href="http://www.wago.com/248-501/000-017">www.wago.com/248-501/000-017</a>
	<p><b>Item no.: 248-501/000-005</b>                  Mini-WSB marking card; as card; not stretchable; plain; snap-on type; red</p>	<a href="http://www.wago.com/248-501/000-005">www.wago.com/248-501/000-005</a>

Subject to changes. Please also observe the further product documentation!





**Item no.: 248-501/000-024**  
Mini-WSB marking card; as card; not stretchable; plain; snap-on type; violet

[www.wago.com/248-501/000-024](http://www.wago.com/248-501/000-024)



**Item no.: 248-501/000-023**  
Mini-WSB marking card; as card; not stretchable; plain; snap-on type; green

[www.wago.com/248-501/000-023](http://www.wago.com/248-501/000-023)



**Item no.: 793-5501/000-007**  
WMB marking card; as card; for terminal block width 5 - 17.5 mm; stretchable 5 - 5.2 mm; plain; snap-on type; gray

[www.wago.com/793-5501/000-007](http://www.wago.com/793-5501/000-007)



**Item no.: 793-5501/000-012**  
WMB marking card; as card; for terminal block width 5 - 17.5 mm; stretchable 5 - 5.2 mm; plain; snap-on type; orange

[www.wago.com/793-5501/000-012](http://www.wago.com/793-5501/000-012)

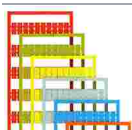

**Item no.: 793-5501/000-014**  
WMB marking card; as card; for terminal block width 5 - 17.5 mm; stretchable 5 - 5.2 mm; plain; snap-on type; brown

[www.wago.com/793-5501/000-014](http://www.wago.com/793-5501/000-014)

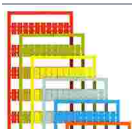

**Item no.: 793-5501/000-017**  
WMB marking card; as card; for terminal block width 5 - 17.5 mm; stretchable 5 - 5.2 mm; plain; snap-on type; light green

[www.wago.com/793-5501/000-017](http://www.wago.com/793-5501/000-017)

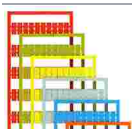

**Item no.: 793-5501/000-023**  
WMB marking card; as card; for terminal block width 5 - 17.5 mm; stretchable 5 - 5.2 mm; plain; snap-on type; green

[www.wago.com/793-5501/000-023](http://www.wago.com/793-5501/000-023)

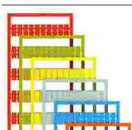

**Item no.: 793-5501/000-024**  
WMB marking card; as card; for terminal block width 5 - 17.5 mm; stretchable 5 - 5.2 mm; plain; snap-on type; violet

[www.wago.com/793-5501/000-024](http://www.wago.com/793-5501/000-024)

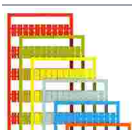

**Item no.: 793-5501/000-005**  
WMB marking card; as card; for terminal block width 5 - 17.5 mm; stretchable 5 - 5.2 mm; plain; snap-on type; red

[www.wago.com/793-5501/000-005](http://www.wago.com/793-5501/000-005)

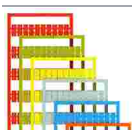

**Item no.: 793-5501/000-002**  
WMB marking card; as card; for terminal block width 5 - 17.5 mm; stretchable 5 - 5.2 mm; plain; snap-on type; yellow



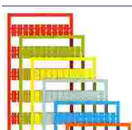

[www.wago.com/793-5501/000-002](http://www.wago.com/793-5501/000-002)



**Item no.: 793-5501/000-006**  
WMB marking card; as card; for terminal block width 5 - 17.5 mm; stretchable 5 - 5.2 mm; plain; snap-on type; blue





[www.wago.com/793-5501/000-006](http://www.wago.com/793-5501/000-006)

Subject to changes. Please also observe the further product documentation!

	<b>Item no.: 793-5501</b> WMB marking card; as card; for terminal block width 5 - 17.5 mm; stretchable 5 - 5.2 mm; plain; snap-on type; white	<a href="http://www.wago.com/793-5501">www.wago.com/793-5501</a>
	<b>Item no.: 2009-115/000-012</b> WMB-Inline; for Smart Printer; 1500 pieces on roll; stretchable 5 - 5.2 mm; plain; snap-on type; orange	<a href="http://www.wago.com/2009-115/000-012">www.wago.com/2009-115/000-012</a>
	<b>Item no.: 2009-115/000-006</b> WMB-Inline; for Smart Printer; 1500 pieces on roll; stretchable 5 - 5.2 mm; plain; snap-on type; blue	<a href="http://www.wago.com/2009-115/000-006">www.wago.com/2009-115/000-006</a>
	<b>Item no.: 2009-115/000-005</b> WMB-Inline; for Smart Printer; 1500 pieces on roll; stretchable 5 - 5.2 mm; plain; snap-on type; red	<a href="http://www.wago.com/2009-115/000-005">www.wago.com/2009-115/000-005</a>







### Testing and measuring

#### Testing accessories

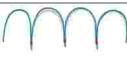
	<b>Item no.: 2009-174</b> Test plug adapter; for 4 mm Ø test plugs; for testing TOPJOB®S rail-mounted terminal blocks; gray	<a href="http://www.wago.com/2009-174">www.wago.com/2009-174</a>
	<b>Item no.: 2009-182</b> Testing tap; for max. 2.5 mm <sup>2</sup> ; tool-free connection for individual test wires 0.08 - 2.5 mm; gray	<a href="http://www.wago.com/2009-182">www.wago.com/2009-182</a>
	<b>Item no.: 2002-611</b> TOPJOB®S L-type test plug module; modular; 1-pole; 2,50 mm <sup>2</sup> ; gray	<a href="http://www.wago.com/2002-611">www.wago.com/2002-611</a>
	<b>Item no.: 2002-649</b> TOPJOB®S L-type spacer module; modular; e.g., for bridging commoned terminal blocks; gray	<a href="http://www.wago.com/2002-649">www.wago.com/2002-649</a>

### Jumpers

#### Jumper

	<b>Item no.: 210-123</b> Wire commoning chain; insulated; blue	<a href="http://www.wago.com/210-123">www.wago.com/210-123</a>
	<b>Item no.: 2002-402</b> Jumper; 2-way; insulated; light gray	<a href="http://www.wago.com/2002-402">www.wago.com/2002-402</a>
	<b>Item no.: 2002-402/000-005</b> Jumper; 2-way; insulated; red	<a href="http://www.wago.com/2002-402/000-005">www.wago.com/2002-402/000-005</a>
	<b>Item no.: 2002-400</b> Continuous jumper; 2-way; insulated; light gray	<a href="http://www.wago.com/2002-400">www.wago.com/2002-400</a>
	<b>Item no.: 2002-403</b> Jumper; 3-way; insulated; light gray	<a href="http://www.wago.com/2002-403">www.wago.com/2002-403</a>
	<b>Item no.: 2002-404/000-005</b> Jumper; 4-way; insulated; red	<a href="http://www.wago.com/2002-404/000-005">www.wago.com/2002-404/000-005</a>

Subject to changes. Please also observe the further product documentation!



**Item no.: 2002-403/000-006**  
Jumper; 3-way; insulated; blue

[www.wago.com/2002-403/000-006](http://www.wago.com/2002-403/000-006)



**Item no.: 2002-404/000-006**  
Jumper; 4-way; insulated; blue

[www.wago.com/2002-404/000-006](http://www.wago.com/2002-404/000-006)



**Item no.: 2002-403/000-005**  
Jumper; 3-way; insulated; red

[www.wago.com/2002-403/000-005](http://www.wago.com/2002-403/000-005)



**Item no.: 2002-405/000-005**  
Jumper; 5-way; insulated; red

[www.wago.com/2002-405/000-005](http://www.wago.com/2002-405/000-005)



**Item no.: 2002-402/000-006**  
Jumper; 2-way; insulated; blue

[www.wago.com/2002-402/000-006](http://www.wago.com/2002-402/000-006)



**Item no.: 2002-405/000-006**  
Jumper; 5-way; insulated; blue

[www.wago.com/2002-405/000-006](http://www.wago.com/2002-405/000-006)



**Item no.: 2002-404**  
Jumper; 4-way; insulated; light gray

[www.wago.com/2002-404](http://www.wago.com/2002-404)



**Item no.: 2002-406/000-006**  
Jumper; 6-way; insulated; blue

[www.wago.com/2002-406/000-006](http://www.wago.com/2002-406/000-006)



**Item no.: 2002-406/000-005**  
Jumper; 6-way; insulated; red

[www.wago.com/2002-406/000-005](http://www.wago.com/2002-406/000-005)



**Item no.: 2002-406/020-000**  
Delta jumper; insulated; light gray

[www.wago.com/2002-406/020-000](http://www.wago.com/2002-406/020-000)



**Item no.: 2002-405**  
Jumper; 5-way; insulated; light gray

[www.wago.com/2002-405](http://www.wago.com/2002-405)



**Item no.: 2002-407/000-005**  
Jumper; 7-way; insulated; red

[www.wago.com/2002-407/000-005](http://www.wago.com/2002-407/000-005)

Subject to changes. Please also observe the further product documentation!



**Item no.: 2002-408**  
Jumper; 8-way; insulated; light gray

[www.wago.com/2002-408](http://www.wago.com/2002-408)



**Item no.: 2002-408/000-006**  
Jumper; 8-way; insulated; blue

[www.wago.com/2002-408/000-006](http://www.wago.com/2002-408/000-006)



**Item no.: 2002-405/011-000**  
Star point jumper; 3-way; insulated; light gray

[www.wago.com/2002-405/011-000](http://www.wago.com/2002-405/011-000)



**Item no.: 2002-407/000-006**  
Jumper; 7-way; insulated; blue

[www.wago.com/2002-407/000-006](http://www.wago.com/2002-407/000-006)



**Item no.: 2002-408/000-005**  
Jumper; 8-way; insulated; red

[www.wago.com/2002-408/000-005](http://www.wago.com/2002-408/000-005)



**Item no.: 2002-407**  
Jumper; 7-way; insulated; light gray

[www.wago.com/2002-407](http://www.wago.com/2002-407)



**Item no.: 2002-406**  
Jumper; 6-way; insulated; light gray

[www.wago.com/2002-406](http://www.wago.com/2002-406)



**Item no.: 2002-410/000-005**  
Jumper; 10-way; insulated; red

[www.wago.com/2002-410/000-005](http://www.wago.com/2002-410/000-005)



**Item no.: 2002-410/000-006**  
Jumper; 10-way; insulated; blue

[www.wago.com/2002-410/000-006](http://www.wago.com/2002-410/000-006)



**Item no.: 2002-410**  
Jumper; 10-way; insulated; light gray

[www.wago.com/2002-410](http://www.wago.com/2002-410)



**Item no.: 2002-409/000-006**  
Jumper; 9-way; insulated; blue

[www.wago.com/2002-409/000-006](http://www.wago.com/2002-409/000-006)



**Item no.: 2002-409/000-005**  
Jumper; 9-way; insulated; red

[www.wago.com/2002-409/000-005](http://www.wago.com/2002-409/000-005)

Subject to changes. Please also observe the further product documentation!



**Item no.: 2002-409**  
Jumper; 9-way; insulated; light gray

[www.wago.com/2002-409](http://www.wago.com/2002-409)



**Item no.: 2002-423/000-006**  
Continuous jumper; from 1 to 3; insulated; blue

[www.wago.com/2002-423/000-006](http://www.wago.com/2002-423/000-006)



**Item no.: 2002-423**  
Continuous jumper; from 1 to 3; insulated; light gray

[www.wago.com/2002-423](http://www.wago.com/2002-423)



**Item no.: 2002-433**  
Jumper; from 1 to 3; insulated; light gray

[www.wago.com/2002-433](http://www.wago.com/2002-433)



**Item no.: 2002-434**  
Jumper; from 1 to 4; insulated; light gray

[www.wago.com/2002-434](http://www.wago.com/2002-434)



**Item no.: 2002-423/000-005**  
Continuous jumper; from 1 to 3; insulated; red

[www.wago.com/2002-423/000-005](http://www.wago.com/2002-423/000-005)



**Item no.: 2002-435**  
Jumper; from 1 to 5; insulated; light gray

[www.wago.com/2002-435](http://www.wago.com/2002-435)



**Item no.: 2002-436**  
Jumper; from 1 to 6; insulated; light gray

[www.wago.com/2002-436](http://www.wago.com/2002-436)



**Item no.: 2002-437**  
Jumper; from 1 to 7; insulated; light gray

[www.wago.com/2002-437](http://www.wago.com/2002-437)



**Item no.: 2002-438**  
Jumper; from 1 to 8; insulated; light gray

[www.wago.com/2002-438](http://www.wago.com/2002-438)



**Item no.: 2002-439**  
Jumper; from 1 to 9; insulated; light gray

[www.wago.com/2002-439](http://www.wago.com/2002-439)



**Item no.: 2002-440**  
Jumper; from 1 to 10; insulated; light gray

[www.wago.com/2002-440](http://www.wago.com/2002-440)



**Item no.: 2002-472**  
Staggered jumper; 2-way; insulated; light gray

[www.wago.com/2002-472](http://www.wago.com/2002-472)



**Item no.: 2002-473**  
Staggered jumper; 3-way; insulated; light gray

[www.wago.com/2002-473](http://www.wago.com/2002-473)



**Item no.: 2002-475/011-000**  
Staggered jumper; 3-way; insulated; light gray















[www.wago.com/2002-475/011-000](http://www.wago.com/2002-475/011-000)



**Item no.: 2002-475**  
Staggered jumper; 5-way; insulated; light gray

[www.wago.com/2002-475](http://www.wago.com/2002-475)











Subject to changes. Please also observe the further product documentation!

	<b>Item no.: 2002-476</b> Staggered jumper; 6-way; insulated; light gray	<a href="http://www.wago.com/2002-476">www.wago.com/2002-476</a>
	<b>Item no.: 2002-474</b> Staggered jumper; 4-way; insulated; light gray	<a href="http://www.wago.com/2002-474">www.wago.com/2002-474</a>
	<b>Item no.: 2002-477</b> Staggered jumper; 7-way; insulated; light gray	<a href="http://www.wago.com/2002-477">www.wago.com/2002-477</a>
	<b>Item no.: 2002-473/011-000</b> Staggered jumper; 2-way; from 1 to 3; insulated; light gray	<a href="http://www.wago.com/2002-473/011-000">www.wago.com/2002-473/011-000</a>
	<b>Item no.: 2002-479</b> Staggered jumper; 9-way; insulated; light gray	<a href="http://www.wago.com/2002-479">www.wago.com/2002-479</a>
	<b>Item no.: 2002-478</b> Staggered jumper; 8-way; insulated; light gray	<a href="http://www.wago.com/2002-478">www.wago.com/2002-478</a>
	<b>Item no.: 2002-479/011-000</b> Staggered jumper; insulated; light gray	<a href="http://www.wago.com/2002-479/011-000">www.wago.com/2002-479/011-000</a>
	<b>Item no.: 2002-480</b> Staggered jumper; 10-way; insulated; light gray	<a href="http://www.wago.com/2002-480">www.wago.com/2002-480</a>
	<b>Item no.: 2002-477/011-000</b> Staggered jumper; insulated; light gray	<a href="http://www.wago.com/2002-477/011-000">www.wago.com/2002-477/011-000</a>
	<b>Item no.: 2002-481/011-000</b> Staggered jumper; insulated; light gray	<a href="http://www.wago.com/2002-481/011-000">www.wago.com/2002-481/011-000</a>
	<b>Item no.: 2002-481</b> Staggered jumper; 11-way; insulated; light gray	<a href="http://www.wago.com/2002-481">www.wago.com/2002-481</a>
	<b>Item no.: 2002-482</b> Staggered jumper; 12-way; insulated; light gray	<a href="http://www.wago.com/2002-482">www.wago.com/2002-482</a>
	<b>Item no.: 210-103</b> Wire commoning chain; insulated; black	<a href="http://www.wago.com/210-103">www.wago.com/210-103</a>
	<b>Item no.: 2002-424/000-006</b> Continuous jumper; from 1 to 4; insulated; blue	<a href="http://www.wago.com/2002-424/000-006">www.wago.com/2002-424/000-006</a>

**Carrier rail**

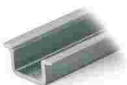
Mounting accessories

Subject to changes. Please also observe the further product documentation!

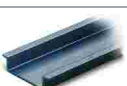
	<b>Item no.: 210-197</b> Steel carrier rail; 35 x 15 mm; 1.5 mm thick; 2 m long; slotted; similar to EN 60715; silver-colored	<a href="http://www.wago.com/210-197">www.wago.com/210-197</a>
	<b>Item no.: 210-198</b> Copper carrier rail; 35 x 15 mm; 2.3 mm thick; 2 m long; unslotted; according to EN 60715; copper-colored	<a href="http://www.wago.com/210-198">www.wago.com/210-198</a>
	<b>Item no.: 210-504</b> Steel carrier rail; 35 x 7.5 mm; 1 mm thick; 2 m long; slotted; galvanized; according to EN 60715; silver-colored	<a href="http://www.wago.com/210-504">www.wago.com/210-504</a>
	<b>Item no.: 210-505</b> Steel carrier rail; 35 x 7.5 mm; 1 mm thick; 2 m long; unslotted; galvanized; according to EN 60715; silver-colored	<a href="http://www.wago.com/210-505">www.wago.com/210-505</a>
	<b>Item no.: 210-506</b> Steel carrier rail; 35 x 15 mm; 1.5 mm thick; 2 m long; unslotted; galvanized; similar to EN 60715; silver-colored	<a href="http://www.wago.com/210-506">www.wago.com/210-506</a>
	<b>Item no.: 210-508</b> Steel carrier rail; 35 x 15 mm; 1.5 mm thick; 2 m long; slotted; galvanized; similar to EN 60715; silver-colored	<a href="http://www.wago.com/210-508">www.wago.com/210-508</a>
	<b>Item no.: 210-113</b> Steel carrier rail; 35 x 7.5 mm; 1 mm thick; 2 m long; unslotted; according to EN 60715; silver-colored	<a href="http://www.wago.com/210-113">www.wago.com/210-113</a>
	<b>Item no.: 210-118</b> Steel carrier rail; 35 x 15 mm; 2.3 mm thick; 2 m long; unslotted; according to EN 60715; silver-colored	<a href="http://www.wago.com/210-118">www.wago.com/210-118</a>
	<b>Item no.: 210-112</b> Steel carrier rail; 35 x 7.5 mm; 1 mm thick; 2 m long; slotted; according to EN 60715; "Hole width 25 mm; silver-colored	<a href="http://www.wago.com/210-112">www.wago.com/210-112</a>
	<b>Item no.: 210-114</b> Steel carrier rail; 35 x 15 mm; 1.5 mm thick; 2 m long; unslotted; similar to EN 60715; silver-colored	<a href="http://www.wago.com/210-114">www.wago.com/210-114</a>
	<b>Item no.: 210-115</b> Steel carrier rail; 35 x 7.5 mm; 1 mm thick; 2 m long; slotted; according to EN 60715; "Hole width 18 mm; silver-colored	<a href="http://www.wago.com/210-115">www.wago.com/210-115</a>
	<b>Item no.: 210-196</b> Aluminum carrier rail; 35 x 8.2 mm; 1.6 mm thick; 2 m long; unslotted; similar to EN 60715; silver-colored	<a href="http://www.wago.com/210-196">www.wago.com/210-196</a>

## Mounting

### Cover carrier



**Item no.: 709-169**  
Cover carrier; Type 3; gray

[www.wago.com/709-169](http://www.wago.com/709-169)

### Cover





**Item no.: 709-156**  
Cover; Type 3; suitable for cover carrier, type 3; 1 m long; transparent

[www.wago.com/709-156](http://www.wago.com/709-156)

Subject to changes. Please also observe the further product documentation!



### Push-in type wire jumper

#### Jumper

	<b>Item no.: 2009-412</b> Push-in type wire jumper; insulated; 60 mm long; black	<a href="http://www.wago.com/2009-412">www.wago.com/2009-412</a>
	<b>Item no.: 2009-414</b> Push-in type wire jumper; 1.5 mm <sup>2</sup> ; insulated; 110 mm long; black	<a href="http://www.wago.com/2009-414">www.wago.com/2009-414</a>
	<b>Item no.: 2009-416</b> Push-in type wire jumper; 1.5 mm <sup>2</sup> ; insulated; 250 mm long; black	<a href="http://www.wago.com/2009-416">www.wago.com/2009-416</a>
	<b>Item no.: 2009-414/000-005</b> Push-in type wire jumper; 1.5 mm <sup>2</sup> ; insulated; 110 mm long; black	<a href="http://www.wago.com/2009-414/000-005">www.wago.com/2009-414/000-005</a>
	<b>Item no.: 2009-414/000-006</b> Push-in type wire jumper; insulated; 110 mm long; black	<a href="http://www.wago.com/2009-414/000-006">www.wago.com/2009-414/000-006</a>

### Tool

#### Operating tool

	<b>Item no.: 210-658</b> Operating tool; Blade: 3.5 x 0.5 mm; with a partially insulated shaft; angled; short; multicoloured	<a href="http://www.wago.com/210-658">www.wago.com/210-658</a>
	<b>Item no.: 210-720</b> Operating tool; Blade: 3.5 x 0.5 mm; with a partially insulated shaft; multicoloured	<a href="http://www.wago.com/210-720">www.wago.com/210-720</a>

### Protective warning marker

#### Cover

	<b>Item no.: 2002-115</b> Protective warning marker; for 5 terminal blocks; with high-voltage symbol, black; yellow	<a href="http://www.wago.com/2002-115">www.wago.com/2002-115</a>
--	--	--

### Downloads

#### Documentation

#### Bid Text

2002-2237 X81 - Datei	2019 Apr 24	xml 4.0 kB	Download
2002-2237 docx - Datei	2019 Apr 18	docx 15.4 kB	Download

Subject to changes. Please also observe the further product documentation!





### Additional Information

Technical Section	pdf	Download
Technical explanations	2.2 MB	

---

### CAD/CAE-Data

#### CAD data

2D/3D Models 2002-2237	URL	Download
------------------------	-----	----------

---

#### CAE data

WSCAD Universe 2002-2237	URL	Download
--------------------------	-----	----------

---

ZUKEN Portal 2002-2237	URL	Download
------------------------	-----	----------

---

EPLAN Data Portal 2002-2237	URL	Download
-----------------------------	-----	----------

---

### Environmental Product Compliance

#### Compliance Search

Environmental Product Compliance 2002-2237	URL	Download
--	-----	----------

Double-deck terminal block; 4-conductor ground terminal block; 2.5 mm<sup>2</sup>; PE; suitable for Ex e II applications; with marker carrier; internal commoning; for DIN-rail 35 x 15 and 35 x 7.5; Push-in CAGE CLAMP®; 2,50 mm<sup>2</sup>; green-yellow

---

### Installation Notes

#### Conductor termination

Subject to changes. Please also observe the further product documentation!

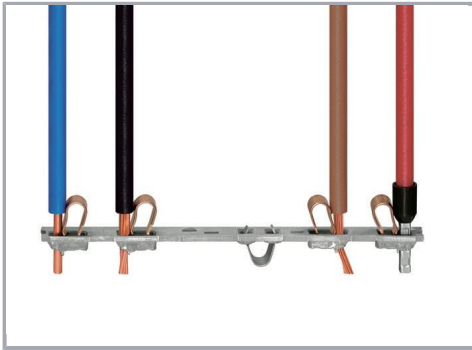

All conductor types at a glance

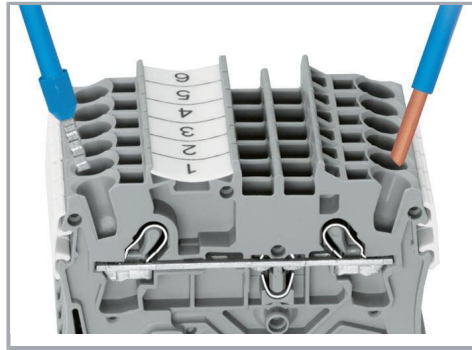

Push-in termination of solid and ferruled conductors

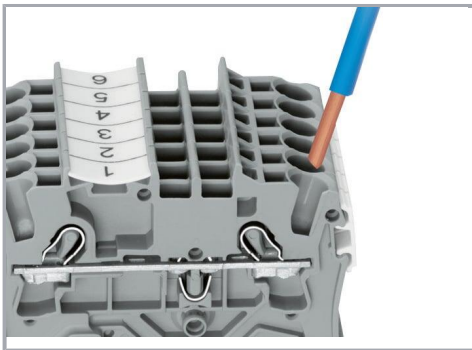

**Inserting a conductor via push-in termination:**

Solid conductors with cross-sections from either one size above, or up to two sizes below, the rated cross-section can be simply pushed in – no tools needed.

Subject to changes. Please also observe the further product documentation!

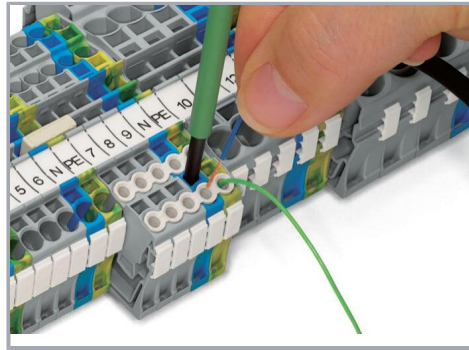
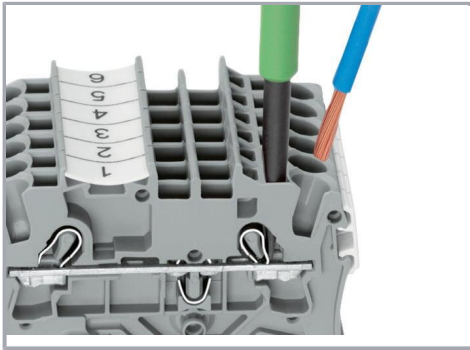

**Inserting a conductor via operating tool:**

**Conductor termination – insulation stop**

Connecting fine-stranded conductors without ferrules, or small cross-sectional conductors that cannot be pushed in, is performed similarly to the original CAGE CLAMP® – just use an operating tool.

**Advantage:**

To open the clamp, the operating tool is inserted vertically. The conductor entry is less than 15 degrees for easier wiring.

**Commoning**

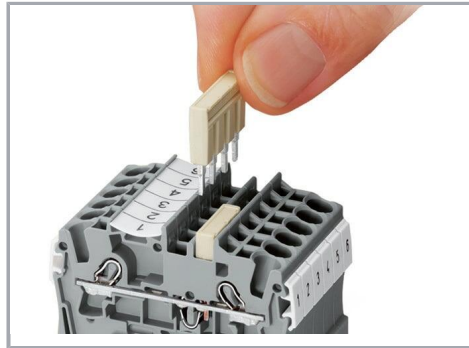
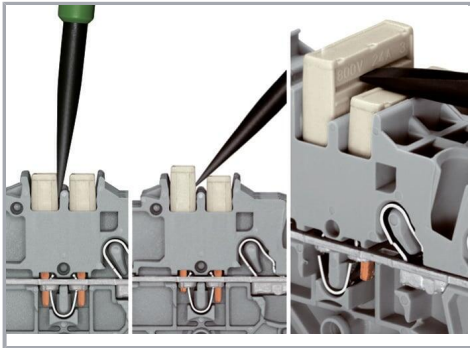

**Removing a push-in type jumper bar:**

Insert push-in type jumper bar and push down until it hits backstop.

Insert the operating tool between the jumper and partition wall of the dual jumper slots, then lift up the jumper.

Place the operating tool in the center of jumpers for up to five contacts (see above), or alternately on both sides for jumpers with more than five contacts.

Subject to changes. Please also observe the further product documentation!

## Marking

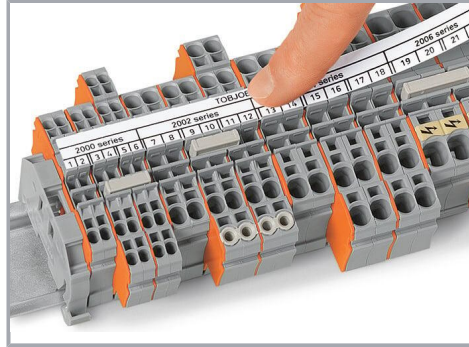
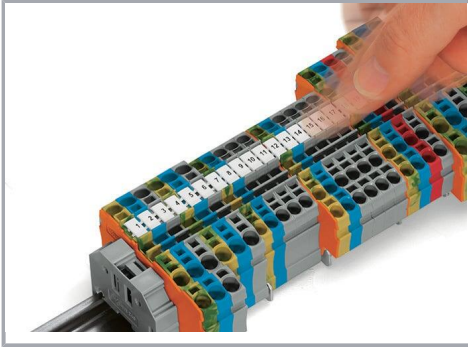

Snapping WMB Inline markers into marker slots.

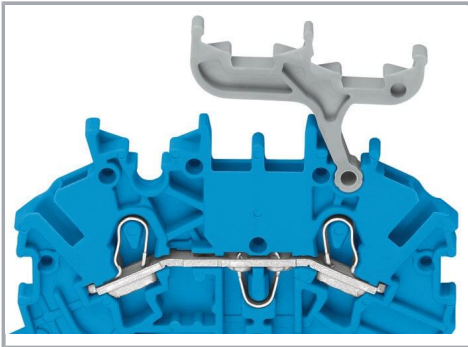

## Double-deck terminal blocks

A double-deck marker carrier (2002-121) can be retrofitted to double-deck terminal blocks without a marker carrier.

## Product family

### TOPJOB® S

TOPJOB® S: In various industrial applications and modern building installations, WAGO's wide and versatile range of rail-mount terminal blocks provides more than just reliable electrical connections.

[Show all products from the family](#)

Subject to changes. Please also observe the further product documentation!