



PURETHERMAL 3

TELEDYNE FLIR Lepton® Smart I/O Module

October 2022 - Datasheet Revision 2

The PureThermal 3 FLIR Lepton Smart I/O Module is a hackable thermal webcam module for the FLIR



Lepton Longwave Infrared (LWIR) camera core. It ships preconfigured to operate as a plug-and-play UVC 1.0 USB thermal webcam that will work with standard webcam apps such as VLC Media Player on PC, Linux, Mac, and Android. Its reference firmware is open source for customized applications. We have also created an open source software application, GetThermal, to view Lepton data on x86 Linux and macOS platforms. For computers using a Microsoft Windows OS you can use the FLIR Lepton User App on the Lepton Getting Started page under the Downloads section. GetThermal as well as the FLIR Lepton User App with a PureThermal 3 (PT3) both support the radiometric mode of Lepton 2.5 & 3.5.



Sample Lepton 3.5 thermal images showing a finished 3D printed object imaged with different colorization settings.

FEATURES

- Powered via USB-C or VIN
- Get Thermal video over USB right out of the box using freeware apps like VLC on Mac, Linux, Windows, or Android
- 9 Hz color video over USB using the [USB UVC class](#)
- STM32F412 ARM microprocessor. Execute on-board image processing without the need for an external system
- Through-holes for GPIO and peripheral breakouts to easily attach other devices
- Open source reference firmware is on the [GroupGets GitHub](#)
- Device Firmware Upgrade (DFU) the STM32 ARM MCU over USB
- Debug via JTAG through a Tag-Connect EC10, an ARM20-CTX, & ST-Link V/2.
- UART, I2C, and GPIO Expansion via standard 0.1" holes
- Compatible with all current 2.x and 3.x Lepton cores
- Compact 25.8 x 28.9mm form-factor that can be embedded into other modules or inconspicuously housed as a standalone web, research, or security camera

APPLICATIONS

- Thermal imaging
- Non-contact temperature measurements
- Motion sensing
- Moisture or leak detection
- Night vision
- Gesture recognition
- Electrical inspection

SPECIFICATIONS

Power Inputs	USB-C, VIN
Input Voltage Range (VIN)	5.5-3.4 VDC, 350mA peak draw
Operating Voltage (Logic level)	3V
Lepton Core Support	Lepton 2.x, 3.x, FS
Expansion	I2C, UART, GPIO, JTAG, SPI
Processor	STM32F412 (1M Flash, 512K RAM)
Thermal Video Outputs	UVC over USB, VoSPI
Part Number	PURETHERMAL-3
RoHS Compliant	Yes

Breakout Pins

Pin #	Label	STM32 Port	Lepton	Type	Notes
1	GPIO 1	PC15-OSC32_OUT	-	I/O	3V, Digital, Analog, Interrupt
16	GPIO 2	PA0	-		3V, Digital, Analog, Interrupt
15	GPIO 3	PH1-OSC_OUT	-		3V, Digital, Analog, Interrupt
2	RST	NRST	-	Reset	LOW to reset
3	CS	PB12	CS	SPI	3V Logic Levels 56Ω resistor on output.
4	SCK	PB13	SCK		
5	MISO	PB14	MISO		
6	MOSI	PB15	MOSI		
7	3V	-	-	OUTPUT	
8	GND	-	-	GND	
9	GND	-	-		
10	VIN	-	-	INPUT	5.5-3.4 VDC, 320mA peak draw
11	SDA	PB9	SDA	I ² C	3V Logic Levels
12	SCL	PB8	SCL		
13	RX	PA3	-	Serial	
14	TX	PA2	-		

Power Consumption

With Lepton 3.X or FS	USB Power - Average (mW)	VIN at 3.7V - Average (mW)
Video over USB	290 ±20	310 ±20
Shutter close (1 second event)	985 ±200	955 ±200
No Lepton	106 ±10	104 ±10

Dimensions

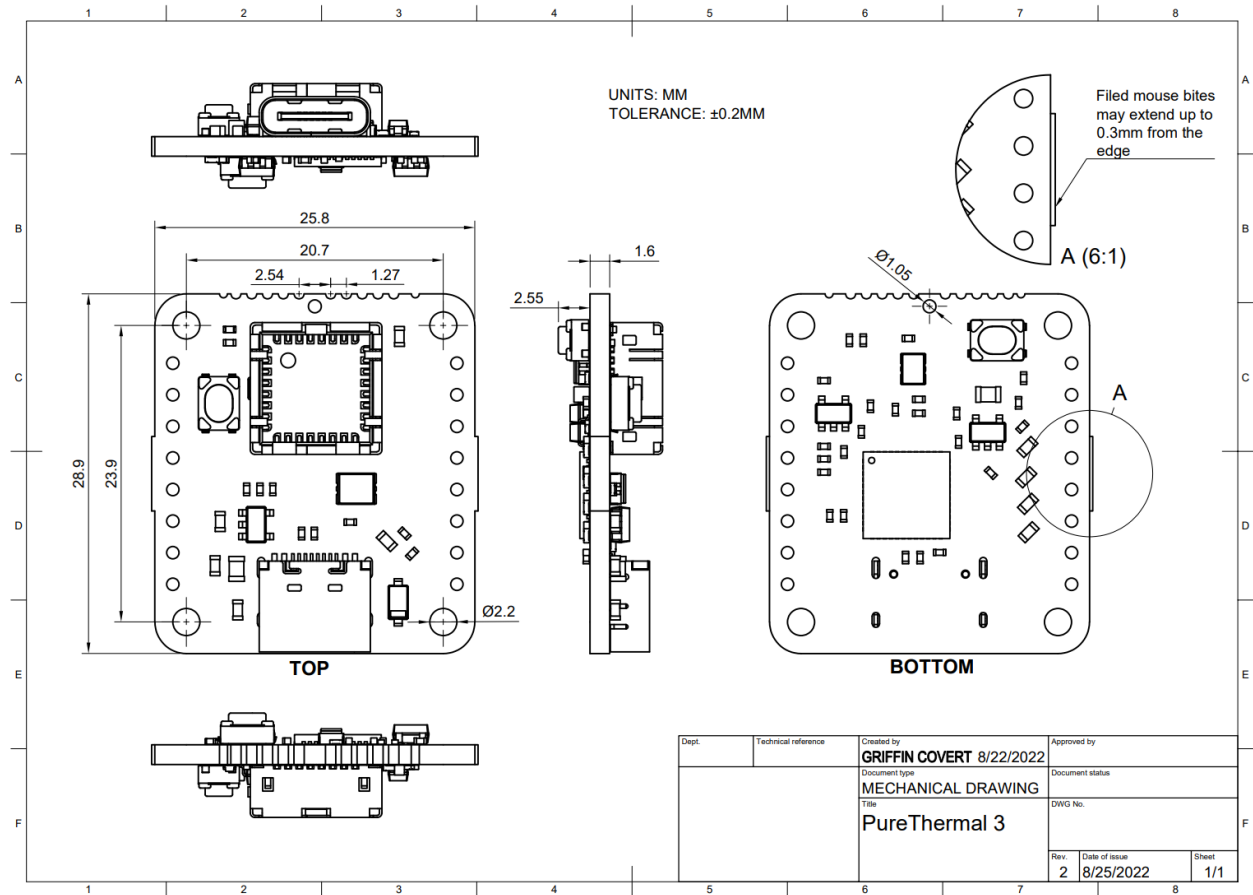

APPLICATION INFORMATION

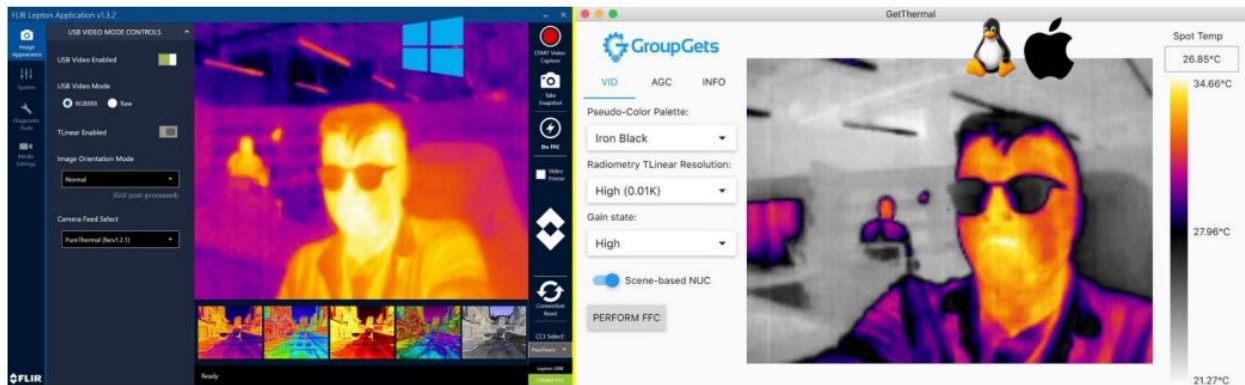

Compatible applications include:

- FLIR Lepton Application for Windows (above image on left).
- GetThermal for Mac OS and Linux (above image on right).
- VLC, and many other video players.

UVC-Capture Examples

The PureThermal FLIR Lepton development board by GroupGets supports the USB video class (UVC), and this makes it very easy to capture thermal imaging data from a host PC using standard tools and libraries. If you want to prototype quickly, your application demands increasing processing power, or you simply don't want to hack on the firmware, check out these examples to get started.

For more information see our purethermal1-uv-capture examples GitHub repository:

<https://github.com/groupgets/purethermal1-uv-capture>

FLIR Lepton Windows SDK

SDK for Windows 10 is provided below. The FLIR Windows Lepton Software Development Kit (SDK) is a software package that you'll include in your project. It is a .NET library for communication over the UVC protocol. These commands allow you to execute commands, pull serial number information, and other useful functions of the camera component. Make sure to visit the Get Started Guide to learn to effectively use the SDK.

<https://lepton.flir.com/sdk/>

Programming PureThermal 3

USB in DFU mode

If you're not compiling from source, you can download the firmware from [our PureThermal Firmware releases section here](#) and substitute the .bin file in the .tgz for main.bin in the commands below.

Entering bootloader (DFU) mode

1. Plug in a USB-C cable.
2. Press and hold the BOOT button.
3. Without releasing BOOT, press and release RST.
4. Release BOOT.
5. When you successfully enter DFU mode, the indicator LED will stop blinking and dim to half brightness.

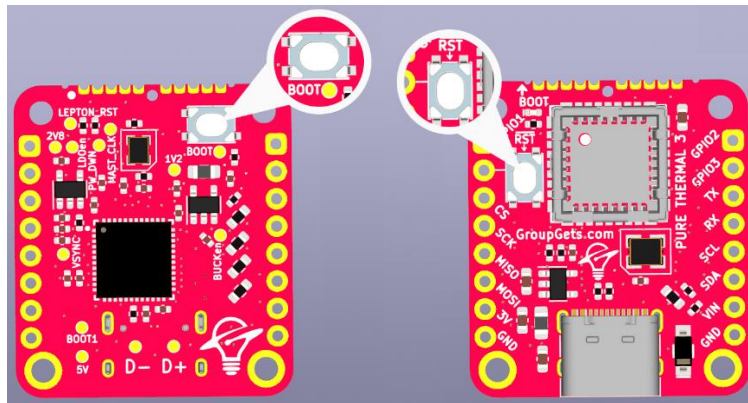

Linux / MacOS Flashing

Install dfu-util:

```
sudo apt-get install dfu-util
```

or

```
brew install dfu-util
```

or your system's package manager.

Then run:

```
dfu-util -a 0 -D main.bin -s 0x08000000
```

or use:

```
scripts/flash.sh
```

Windows Flashing

DfuSE USB drivers: <https://www.st.com/en/development-tools/stsw-stm32080.html>

win32 DFU tools https://files.groupgets.com/purethermal/win32_dfu.zip

To install DFU drivers, may need to use the device manager to select the st drivers

extract win32_dfu.zip to the current folder.

```
win32_dfu\bin2dfu --i main.bin --a 0x08000000 --o main.dfu  
win32_dfu\DfuSeCommand -c -d --fn main.dfu
```

or use:

```
scripts/make_and_flash.bat
```

Alternate Flashing Method (not over usb)

The latest PureThermal firmware release is available [here](#).

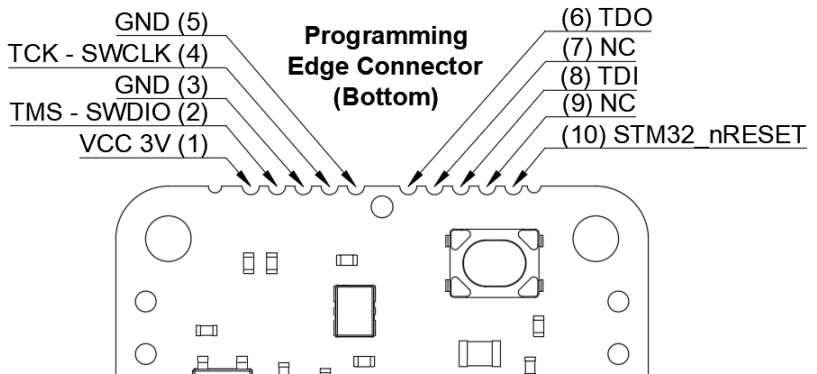

Windows Flashing

Using the hardware below:

- ST-Link V2
- [TagConnect EC10-IDC-050](#) (normal orientation)
- [Olimex ARM-JTAG-20-10 adapter](#) or similar

1. [Download the STM32 ST-LINK Utility](#) (STSW-LINK004)
2. Install STM32 ST-Link Utility and then open the software.
3. Plug the PureThermal 3 into USB and insert the Tag-Connect EC10 connector.
4. Select "Target" then "Connect" to connect the software to the PureThermal device.
5. Next select "File" then "Open file...", now navigate to the folder which contains the PureThermal firmware and select the main.dfu file.
6. Finally click "Target" then "Program & Verify...", make sure that the "Reset after programming" box is selected then press the "Start" button.

FUNCTIONS

LED: When plugged in to micro-usb power and a Lepton is inserted in the socket LED will flash slowly. When video is being transmitted to the viewing program, LED will flash more rapidly.

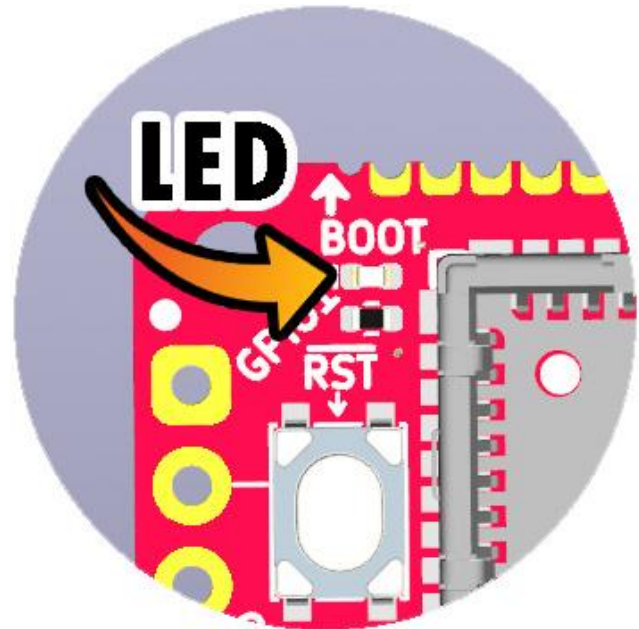

PureThermal 3 Silkscreen Diagram

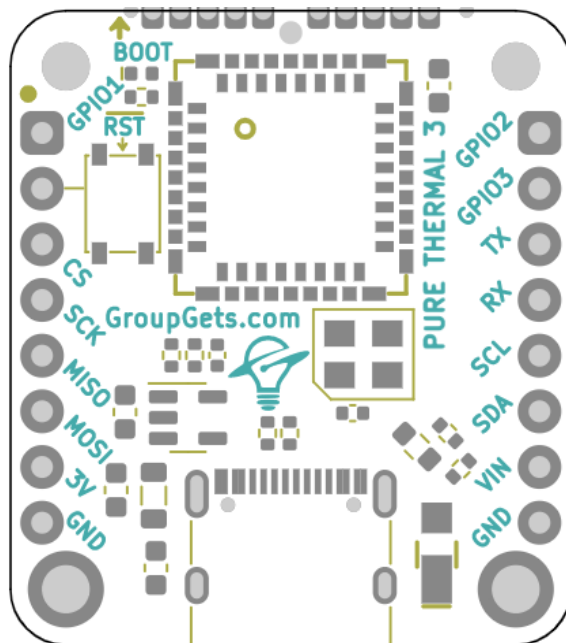

TOP

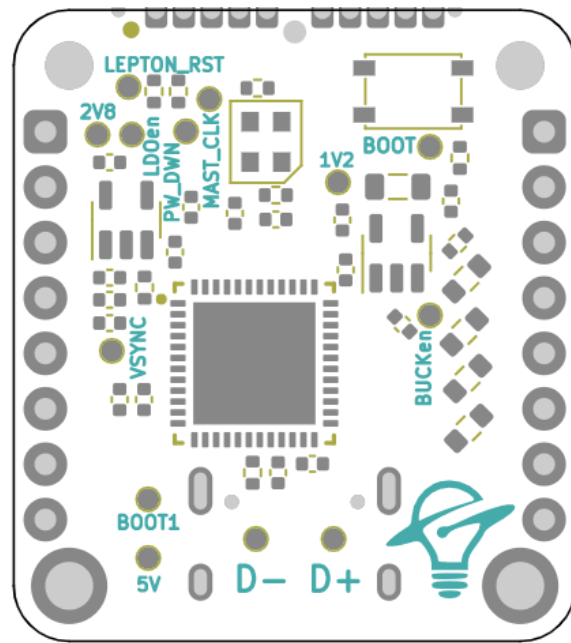

BOTTOM

Revision History

Revision 2 – October 2022

- Added to applications list
- More details in Specifications table
- Added breakout pin table
- Added Power consumption table
- Improved programming edge connector diagram and added pin numbers
- Added revision history

Revision 1 – August 2022

- Datasheet created