

## Silicon PIN Photodiode

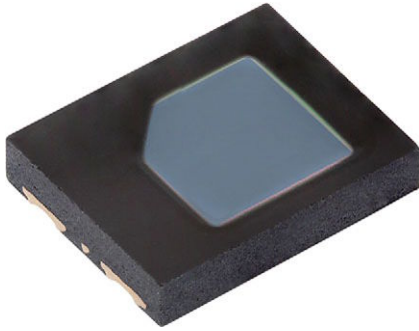

### DESCRIPTION

VEMD5510C is a high speed and high sensitive PIN photodiode. It is a low profile surface-mount device (SMD) including the chip with a 7.5 mm<sup>2</sup> sensitive area detecting visible light much like the human eye. The diode has its peak sensitivity at 550 nm and a low capacitance.

### FEATURES

- Package type: surface-mount
- Package form: top view
- Dimensions (L x W x H in mm): 5 x 4 x 0.9
- Radiant sensitive area (in mm<sup>2</sup>): 7.5
- High photo sensitivity
- Suppression filter for near infrared radiation
- Fast response times
- Angle of half sensitivity:  $\phi = \pm 65^\circ$
- Floor life: 72 h, MSL 4, according to J-STD-020
- Material categorization: for definitions of compliance please see [www.vishay.com/doc?99912](http://www.vishay.com/doc?99912)



### APPLICATIONS

- Wearables
- Optical heart rate monitoring
- Ambient light sensors

### PRODUCT SUMMARY

COMPONENT	$I_{ra}$ ( $\mu A$ )	$\phi$ ( $^\circ$ )	$\lambda_{0.5}$ (nm)
VEMD5510C	0.6	$\pm 65$	440 to 700

#### Note

- Test conditions see table "Basic Characteristics"

### ORDERING INFORMATION

ORDERING CODE	PACKAGING	REMARKS	PACKAGE FORM
VEMD5510C	Tape and reel	MOQ: 1000 pcs, 1000 pcs/reel	Top view
VEMD5510C-GS15	Tape and reel	MOQ: 5000 pcs, 5000 pcs/reel	Top view

#### Note

- MOQ: minimum order quantity

### ABSOLUTE MAXIMUM RATINGS ( $T_{amb} = 25^\circ C$ , unless otherwise specified)

PARAMETER	TEST CONDITION	SYMBOL	VALUE	UNIT
Reverse voltage		$V_R$	20	V
Power dissipation	$T_{amb} \leq 25^\circ C$	$P_V$	215	mW
Junction temperature		$T_j$	110	$^\circ C$
Operating temperature range		$T_{amb}$	-40 to +100	$^\circ C$
Storage temperature range		$T_{stg}$	-40 to +100	$^\circ C$
Soldering temperature	According to reflow solder profile Fig. 8	$T_{sd}$	260	$^\circ C$
Thermal resistance junction-to-ambient		$R_{thJA}$	350	K/W
ESD safety HBM	$\pm 2000$ V, 1.5 k $\Omega$ , 100 pF, 3 pulses	$ESD_{HBM}$	$\geq 2$	kV

<b>BASIC CHARACTERISTICS</b> ( $T_{amb} = 25\text{ }^{\circ}\text{C}$ , unless otherwise specified)						
PARAMETER	TEST CONDITION	SYMBOL	MIN.	TYP.	MAX.	UNIT
Forward voltage	$I_F = 50\text{ mA}$	$V_F$	-	0.9	1.3	V
Breakdown voltage	$I_R = 100\text{ }\mu\text{A}$ , $E = 0$	$V_{(BR)}$	20	-	-	V
Reverse dark current	$V_R = 10\text{ V}$ , $E = 0$	$I_{r0}$	-	0.2	10	nA
Diode capacitance	$V_R = 0\text{ V}$ , $f = 1\text{ MHz}$ , $E = 0$	$C_D$	-	80	-	pF
	$V_R = 3\text{ V}$ , $f = 1\text{ MHz}$ , $E = 0$	$C_D$	-	30	40	pF
Open circuit voltage	$E_V = 100\text{ lx}$ , CIE illuminant A	$V_o$	-	240	-	mV
Temperature coefficient of $V_o$	$E_V = 100\text{ lx}$ , CIE illuminant A	$TK_{V_o}$	-	-2.5	-	mV/K
Short circuit current	$E_V = 100\text{ lx}$ , CIE illuminant A	$I_k$	-	0.6	-	$\mu\text{A}$
Reverse light current	$E_e = 0.2\text{ mW/cm}^2$ , $\lambda = 525\text{ nm}$ , $V_R = 5\text{ V}$	$I_{ra}$	2.0	2.6	-	$\mu\text{A}$
	$E_V = 100\text{ lx}$ , CIE illuminant A, $V_R = 5\text{ V}$	$I_{ra}$	0.46	0.55	-	$\mu\text{A}$
Angle of half sensitivity		$\phi$	-	$\pm 65$	-	$^{\circ}$
Wavelength of peak sensitivity		$\lambda_p$	-	550	-	nm
Range of spectral bandwidth		$\lambda_{0.5}$	-	440 to 700	-	nm
Rise time	$V_R = 5\text{ V}$ , $R_L = 50\text{ }\Omega$ , $\lambda = 525\text{ nm}$	$t_r$	-	40	-	ns
Fall time	$V_R = 5\text{ V}$ , $R_L = 50\text{ }\Omega$ , $\lambda = 525\text{ nm}$	$t_f$	-	30	-	ns

**BASIC CHARACTERISTICS** ( $T_{amb} = 25\text{ }^{\circ}\text{C}$ , unless otherwise specified)

Basic characteristics graphs to be extended to  $110\text{ }^{\circ}\text{C}$  ambient temperatures where applicable.

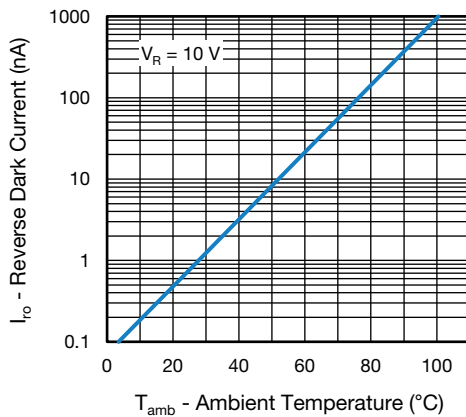

Fig. 1 - Reverse Dark Current vs. Ambient Temperature

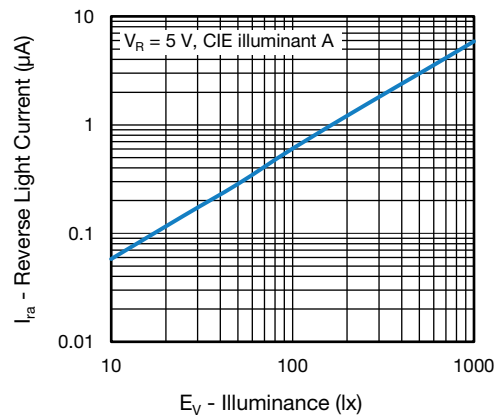

Fig. 2 - Reverse Light Current vs. Irradiance

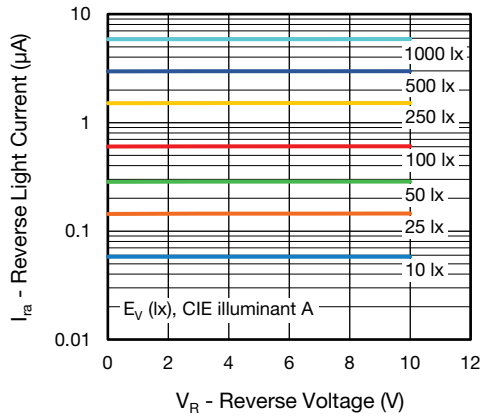

Fig. 3 - Reverse Light Current vs. Reverse Voltage

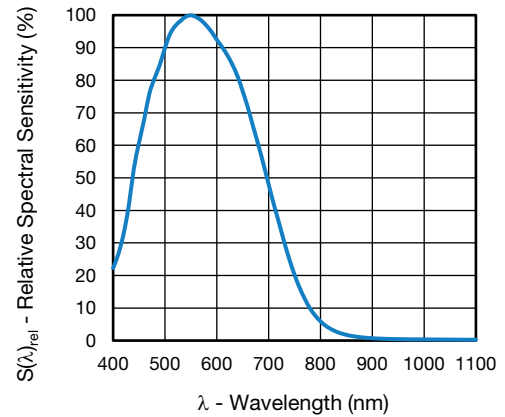

Fig. 5 - Relative Spectral Sensitivity vs. Wavelength

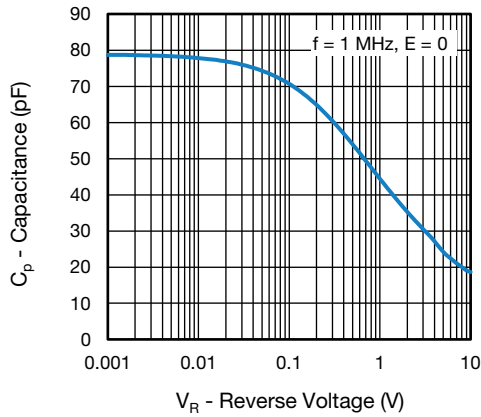

Fig. 4 - Diode Capacitance vs. Reverse Voltage

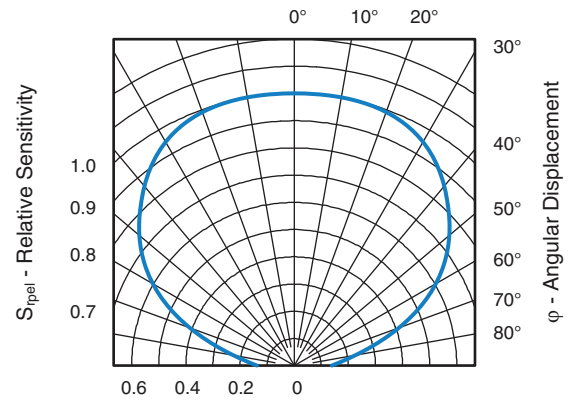
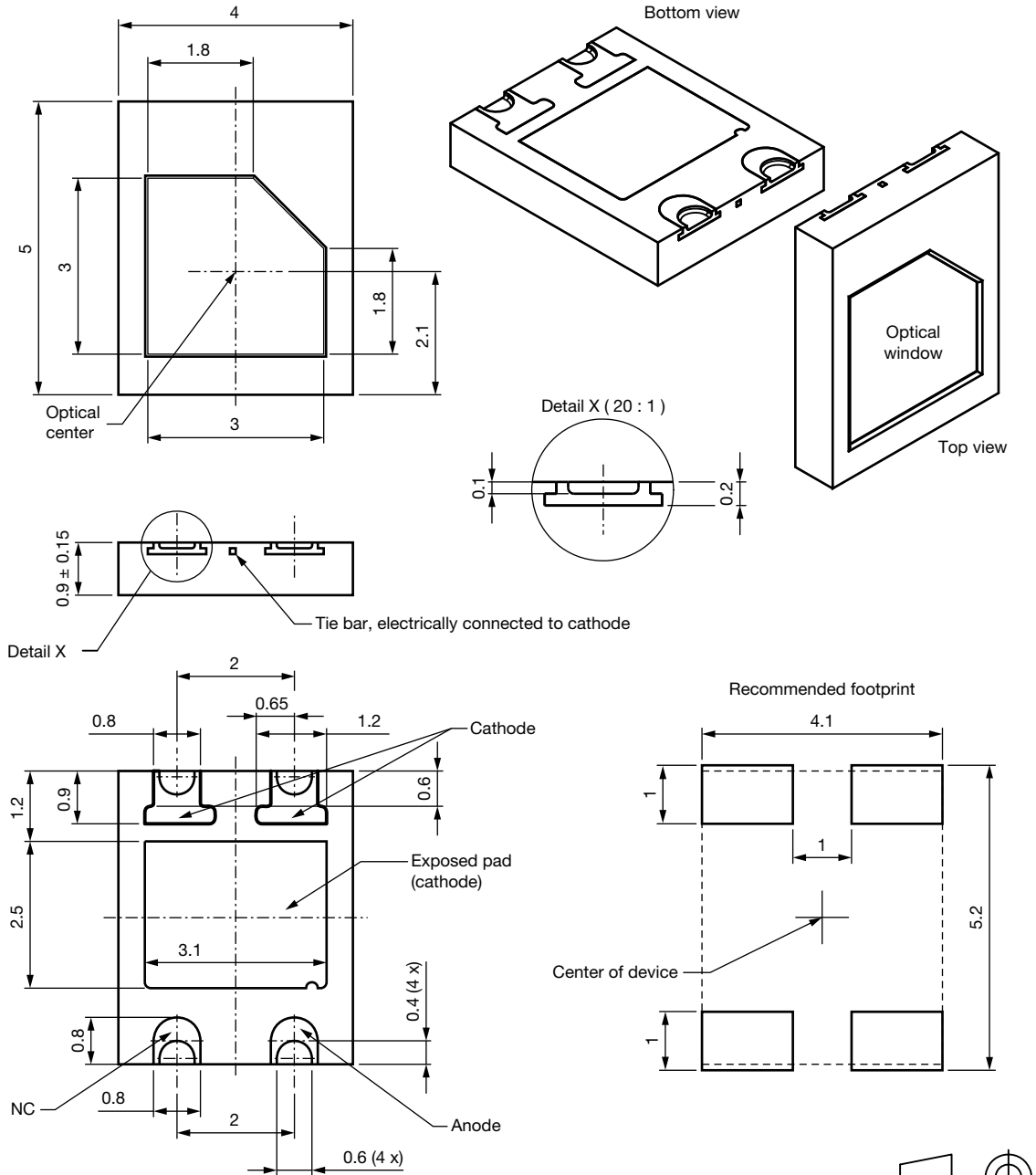

Fig. 6 - Relative Sensitivity vs. Angular Displacement

**PACKAGE DIMENSIONS** in millimeters



Drawing- No.: 6.550-5329.01-4  
Issue: 3; 11.11.2016

Not indicated tolerances  $\pm 0.1$

Technical drawings according to DIN specification



TAPE AND REEL DIMENSIONS in millimeters

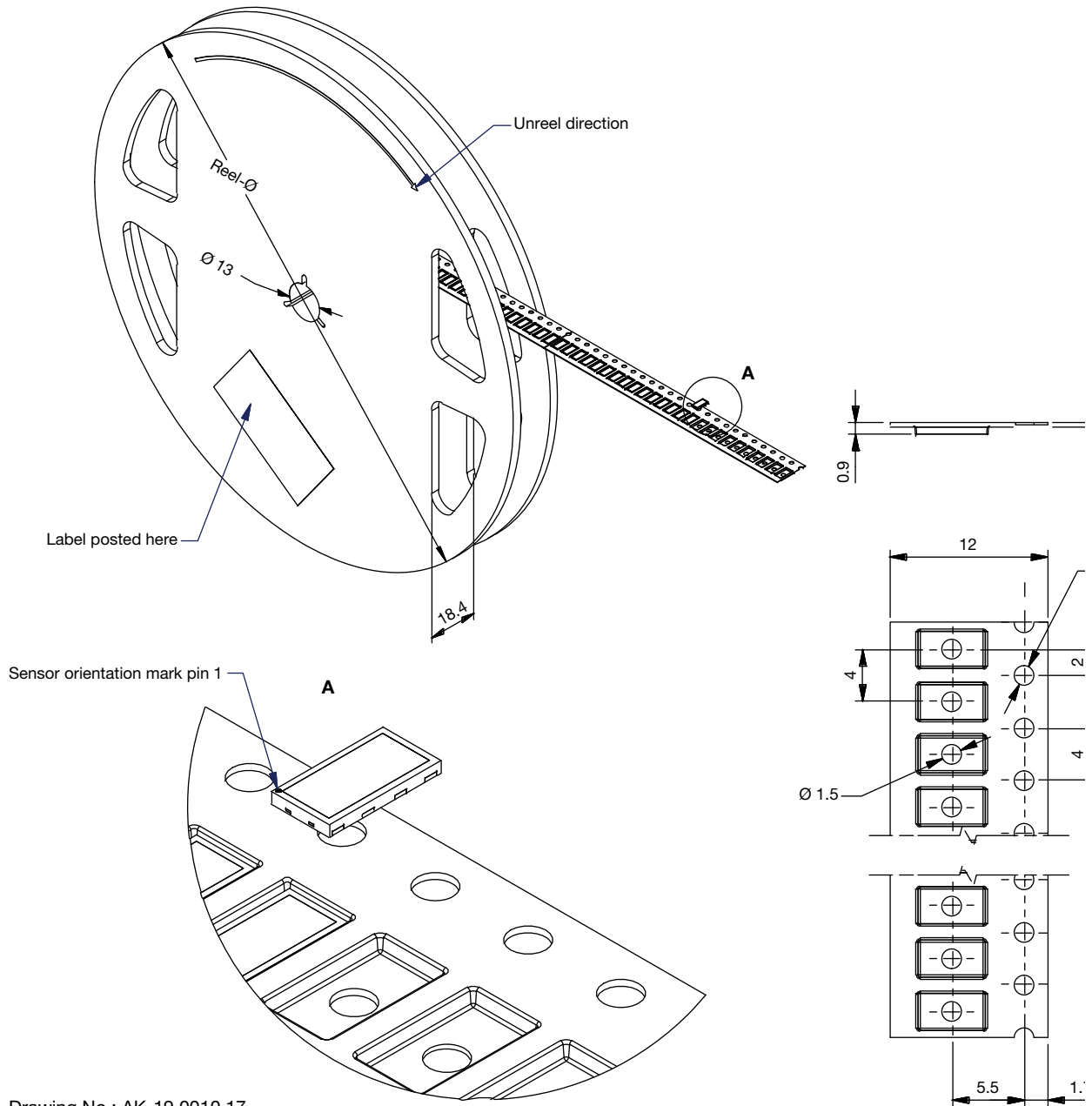

Drawing No.: AK-19.0010.17  
Issue: preliminary; 01.09.2017



**SOLDER PROFILE**



19841

Fig. 7 - Lead (Pb)-free Reflow Solder Profile According to J-STD-020D

**DRYPACK**

Devices are packed in moisture barrier bags (MBB) to prevent the products from moisture absorption during transportation and storage. Each bag contains a desiccant.

**FLOOR LIFE**

Time between soldering and removing from MBB must not exceed the time indicated in J-STD-020:

Moisture sensitivity: level 4

Floor life: 72 h

Conditions:  $T_{amb} < 30\text{ }^{\circ}\text{C}$ ,  $\text{RH} < 60\text{ }%$

**DRYING**

In case of moisture absorption devices should be baked before soldering. Conditions see J-STD-020 or recommended conditions:

192 h at  $40\text{ }^{\circ}\text{C}$  (+ 5 °C),  $\text{RH} < 5\text{ }%$

or

96 h at  $60\text{ }^{\circ}\text{C}$  (+ 5 °C),  $\text{RH} < 5\text{ }%$



## **Disclaimer**

ALL PRODUCT, PRODUCT SPECIFICATIONS AND DATA ARE SUBJECT TO CHANGE WITHOUT NOTICE TO IMPROVE RELIABILITY, FUNCTION OR DESIGN OR OTHERWISE.

Vishay Intertechnology, Inc., its affiliates, agents, and employees, and all persons acting on its or their behalf (collectively, "Vishay"), disclaim any and all liability for any errors, inaccuracies or incompleteness contained in any datasheet or in any other disclosure relating to any product.

Vishay makes no warranty, representation or guarantee regarding the suitability of the products for any particular purpose or the continuing production of any product. To the maximum extent permitted by applicable law, Vishay disclaims (i) any and all liability arising out of the application or use of any product, (ii) any and all liability, including without limitation special, consequential or incidental damages, and (iii) any and all implied warranties, including warranties of fitness for particular purpose, non-infringement and merchantability.

Statements regarding the suitability of products for certain types of applications are based on Vishay's knowledge of typical requirements that are often placed on Vishay products in generic applications. Such statements are not binding statements about the suitability of products for a particular application. It is the customer's responsibility to validate that a particular product with the properties described in the product specification is suitable for use in a particular application. Parameters provided in datasheets and / or specifications may vary in different applications and performance may vary over time. All operating parameters, including typical parameters, must be validated for each customer application by the customer's technical experts. Product specifications do not expand or otherwise modify Vishay's terms and conditions of purchase, including but not limited to the warranty expressed therein.

Except as expressly indicated in writing, Vishay products are not designed for use in medical, life-saving, or life-sustaining applications or for any other application in which the failure of the Vishay product could result in personal injury or death. Customers using or selling Vishay products not expressly indicated for use in such applications do so at their own risk. Please contact authorized Vishay personnel to obtain written terms and conditions regarding products designed for such applications.

No license, express or implied, by estoppel or otherwise, to any intellectual property rights is granted by this document or by any conduct of Vishay. Product names and markings noted herein may be trademarks of their respective owners.