

Chassis Mount

CH / CL Series

Filter Chokes - Single and Dual Windings

Signal's CH and CL Filter Chokes are designed to complement the Step Down Multi-Tapped Isolating transformers. When combined, the Multi-Tapped Transformer and Filter Choke support the development platform of highly reliable conventional DC Power Supplies.

General Specifications

- Inductance - 0.12 mHY to 100 mHY
- DC Current - 1.0 ADC to 200 ADC
- Insulation System - Class B insulation, 130° C



CH / CL Series Datasheet

Part Number Selection

Part Number	Inductance	Current	Resistance	Mounting Style	Dimensions					Mounting Screw	Weight
					L	W	H	ML	MW		
	mHY	Amps	Ohms		Inches (mm)					lbs (kg)	
CH-1	100	1	1.5	B	3.00 (76.2)	2.50 (63.5)	2.50 (63.5)	2.50 (63.5)	2.00 (50.8)	#8	2.3 (1.04)
CH-2	70	2	0.9	B	3.37 (85.7)	2.75 (69.9)	2.87 (73.0)	2.81 (71.4)	2.12 (53.9)	#8	3.2 (1.45)
CH-4	70	4	0.6	B	3.75 (95.3)	3.12 (79.4)	3.25 (82.6)	3.12 (79.4)	2.50 (63.5)	#8	5.3 (2.40)
CH-6	40	6	0.4	B	3.75 (95.3)	3.62 (92.1)	3.25 (82.6)	3.12 (79.4)	3.00 (76.2)	#8	6.5 (2.95)
CH-8	30	8	0.3	B	4.12 (104.8)	3.62 (92.1)	3.50 (88.9)	3.43 (87.3)	3.00 (76.2)	#10	8 (3.63)
CH-12	15	12	0.1	B	5.25 (133.4)	4.00 (101.6)	4.43 (112.7)	4.37 (111.1)	3.12 (79.4)	#10	13.7 (6.21)
CH-16	15	16	0.08	B	5.25 (133.4)	4.62 (117.5)	4.43 (112.7)	4.37 (111.1)	3.62 (92.0)	#10	17.5 (7.94)
CH-20	7	20	0.05	B	5.25 (133.4)	4.00 (101.6)	4.43 (112.7)	4.37 (111.1)	3.12 (79.4)	#10	13.3 (6.03)
CH-25	5	25	0.025	B	5.25 (133.4)	4.75 (120.7)	4.43 (112.7)	4.37 (111.1)	3.87 (98.4)	#10	17.8 (8.07)
CH-30	4	30	0.01	B	6.37 (161.9)	5.00 (127.0)	5.37 (136.5)	5.31 (134.9)	3.37 (85.7)	1/4	24.4 (11.07)
CH-50	1.4	50	0.01	B	6.37 (161.9)	5.25 (133.4)	5.37 (136.5)	5.31 (134.9)	3.75 (95.3)	1/4	26.7 (12.11)
CH-100	0.5	100	0.005	B	6.37 (161.9)	6.25 (158.8)	5.37 (136.5)	5.31 (134.9)	4.12 (104.8)	1/4	31.4 (14.24)
CH-200	0.3	200	0.001	B	7.50 (190.5)	7.50 (190.5)	6.25 (158.8)	6.75 (171.5)	4.12 (104.8)	1/4	48.0 (21.77)

Part Number	Series Connected			Parallel Connected			Mounting Style	Dimensions					Mounting Screw	Weight
	Ind.	Curr.	Res.	Ind.	Curr.	Res.		L	W	H	ML	MW		
	mHY	Amps	Ohms	mHY	Amps	Ohms		Inches (mm)					lbs (kg)	
CL-1-2	72	1	1.4	18	2	0.35	C	2.87 (73.0)	1.75 (44.5)	2.31 (58.7)	2.37 (60.3)	—	#8	0.9 (0.41)
CL-2-4	40	2	0.7	10	4	0.18	C	3.12 (79.4)	2.12 (53.9)	2.75 (69.9)	2.81 (71.4)	—	#8	1.5 (0.68)
CL-4-8	20	4	0.3	5	8	0.075	B	3.00 (76.2)	2.87 (73.0)	2.50 (63.5)	2.50 (63.5)	2.50 (63.5)	#8	3.0 (1.36)
CL-6-12	12	6	0.15	3	12	0.038	B	3.37 (85.7)	3.06 (77.7)	2.81 (71.4)	2.81 (71.4)	2.50 (63.5)	#8	4.0 (1.81)
CL-12-24	4.8	12	0.052	1.2	24	0.013	B	3.37 (85.7)	3.56 (90.5)	2.81 (71.4)	2.81 (71.4)	3.00 (76.2)	#8	5.3 (2.40)
CL-25-50	1.2	25	0.012	0.3	50	0.003	B	3.75 (95.3)	3.37 (85.7)	3.37 (85.7)	3.12 (79.4)	2.75 (69.9)	#8	6.0 (2.72)
CL-50-100	0.5	50	0.0043	0.12	100	0.0011	B	4.50 (114.3)	3.75 (95.3)	3.75 (95.3)	3.75 (95.3)	2.50 (63.5)	#8	8.0 (3.63)

Signal's dual chokes are supplied with 2 windings which may be series or parallel connected with rating shown on chart. This line is designed for applications requiring lower inductance value at high currents such as low voltage, DC supplies or SCR filters.



Custom versions available upon request.



128 Atlantic Avenue, Lynbrook, NY 11563
Toll Free 866-239-5777 | Tel 516-239-5777 | Fax 516-239-7208
sales@signaltransformer.com | techhelp@signaltransformer.com

belfuse.com/signal

Mechanical Specifications

Series

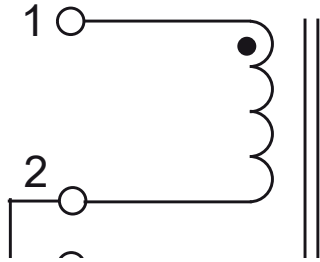

Parallel

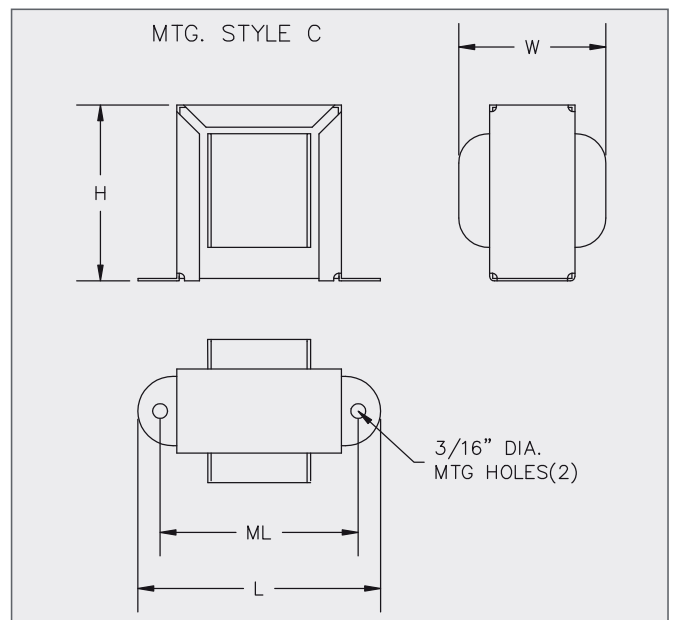
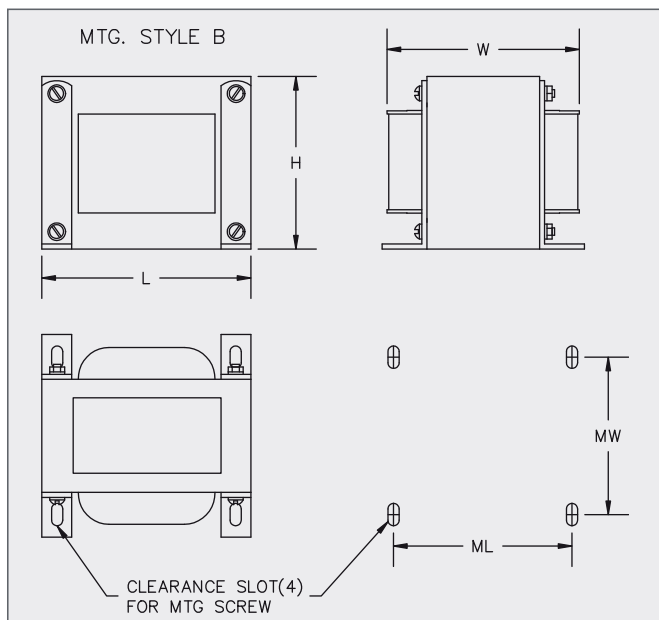
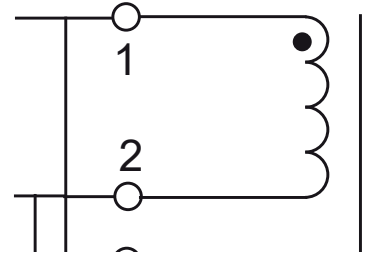

Custom versions available upon request.



128 Atlantic Avenue, Lynbrook, NY 11563
Toll Free 866-239-5777 | Tel 516-239-5777 | Fax 516-239-7208
sales@signaltransformer.com | techhelp@signaltransformer.com

belfuse.com/signal