

Overview

These filters are adapted to attenuate high-frequency noise that may degrade performance or a lifetime of photovoltaic panels. They also reduce EMI noise radiation that may emerge from the panels and connection cables. The filters are geometrically optimized and are designed for the lowest power loss. Two versions are available, with or without Y capacitors, to support various inverter topologies. X and Y capacitors are selected from KEMET's wide range for highest performance and reliability.

Applications

This filter is intended to be used in photovoltaic applications between the solar panel and the inverter system. It can be used within the specifications in any other DC application, such as battery chargers, energy storage systems, and UPS machines.

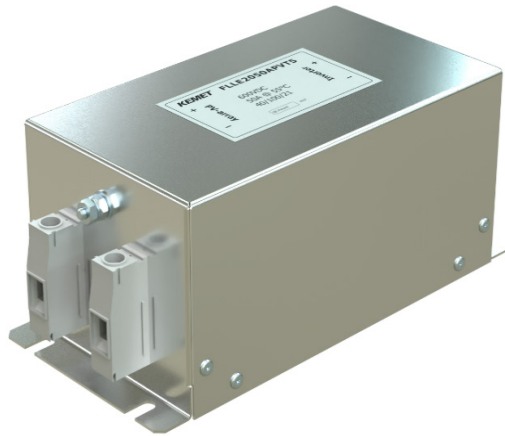

Technical Specifications

Item	Parameters/Characteristics	
Rated Voltage	600 VDC	1,200 VDC
Rated Current	25 – 150 A	250 – 2,500 A
Rated Temperature	55°C	55°C
Temperature Range	-40°C to 100°C	-40°C to 100°C
Climate Category	40/100/21	40/100/21
Voltage Test	P → P 1,300 VDC P → E 1,300 VDC	P → P 3,000 VDC P → E 3,600 VDC

Typical Electrical Schematic

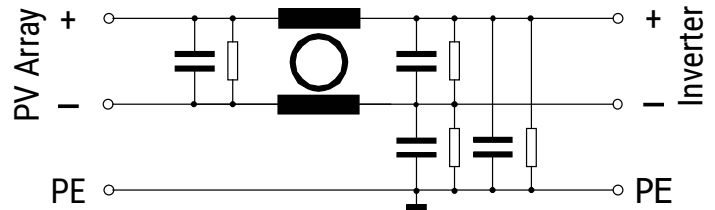

Part Number	Rated Current at 55°C (A)	Power Loss at 25°C/DC (W)	Weight (kg)
FLLE2025AP(*)T3	25	4	1.3
FLLE2050AP(*)T5	50	6	1.8
FLLE2075AP(*)T5	75	10	2.0
FLLE2100AP(*)T6	100	15	2.5
FLLE2150AP(*)T7	150	20	3.0
FLLE2250AP(*)I1	250	10	10
FLLE2400AP(*)I1	400	15	15
FLLE2600AP(*)I1	600	25	25
FLLE2800AP(*)I1	800	30	30
FLLE21K0AP(*)I1	1,000	45	45
FLLE21K6AP(*)I1	1,600	70	70
FLLE22K5AP(*)I1	2,500	150	150

(*) To complete KEMET part number, insert V = Standard, X = Without Y capacitors

Approvals

The FLLE2 – PV is designed according to IEC/EN/UL 60939 and UL 1283.

Environmental Compliance

KEMET EMI filters are RoHS Compliant.



Typical Insertion Loss

25 to 150 A

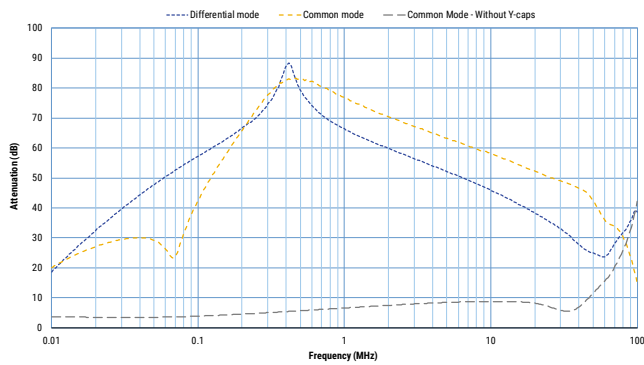

250 to 2,500 A

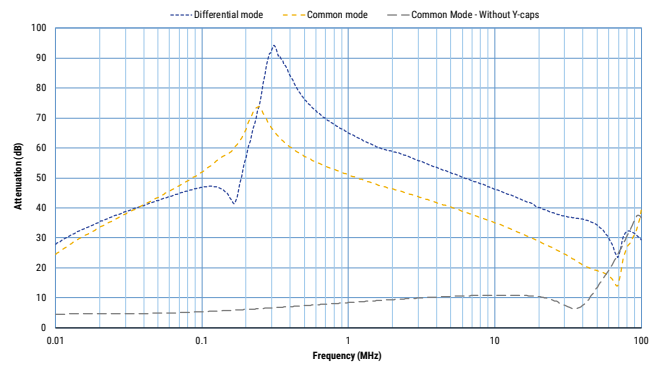

Mechanical Dimensions – Millimeters

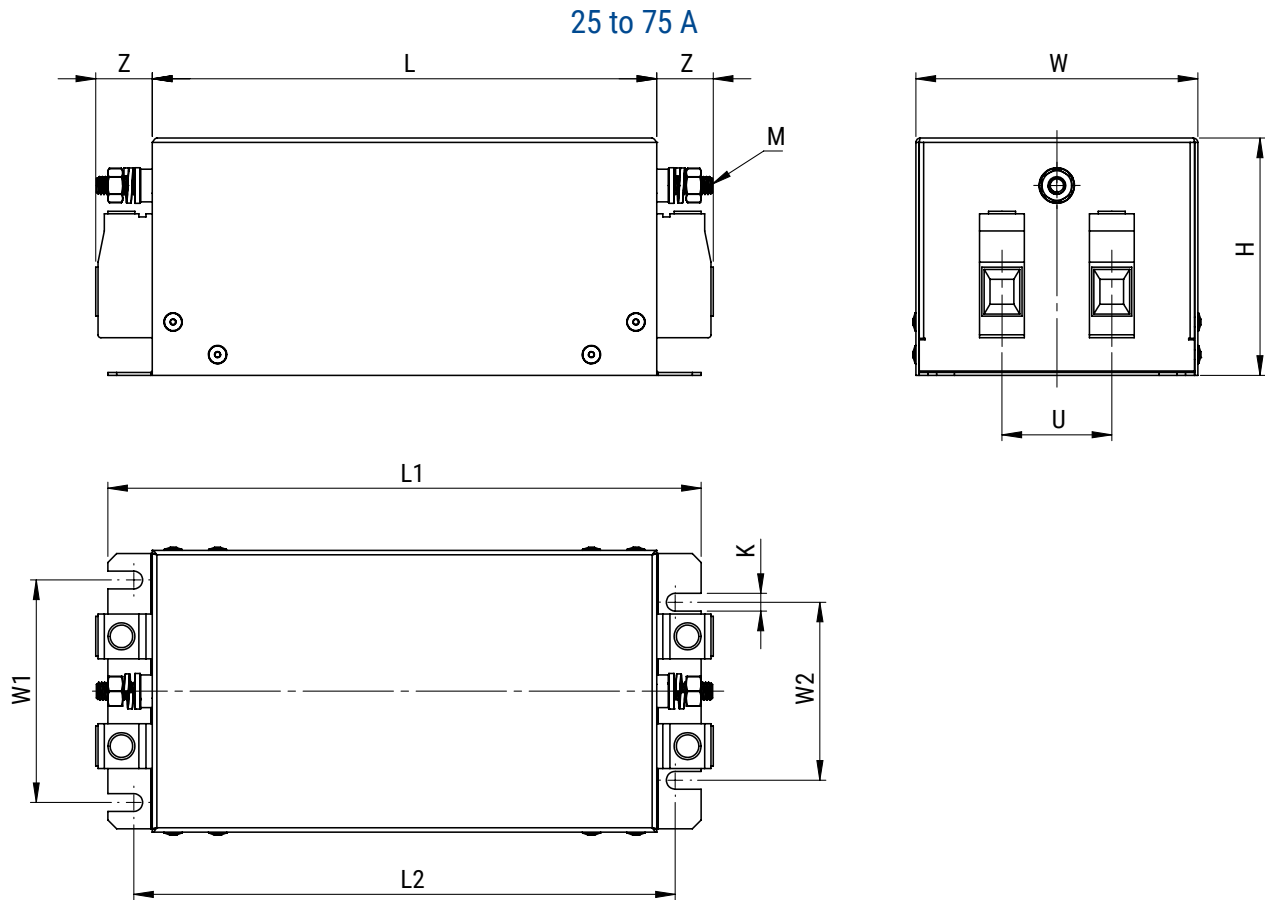

Part Number	Dimensions in mm											Terminal block	
	L	L1	L2	W	W1	W2	H	U	Z	K	M	Wire	Torque
													(mm ²)
FLLE2025AP(*)T3	140	170	153	80	50	60	65	25	15	5.5	M5	1 – 10	1.2 – 1.5
FLLE2050AP(*)T5	170	200	183	95	60	75	80	37	19	6.5	M6	10 – 25	3 – 4
FLLE2075AP(*)T5	170	200	183	95	60	75	80	37	19	6.5	M6	10 – 25	3 – 4
FLLE2100AP(*)T6	190	220	203	125	90	100	95	40	43	6.5	M8	16 – 50	6 – 8
FLLE2150AP(*)T7	220	250	233	140	100	120	115	45	50	6.5	M10	35 – 95	15 – 20

(*) To complete KEMET part number, insert V = Standard, X = Without Y capacitors
 Tolerances, if not stated, according to ISO 2768-c.

Mechanical Dimensions – Millimeters cont.

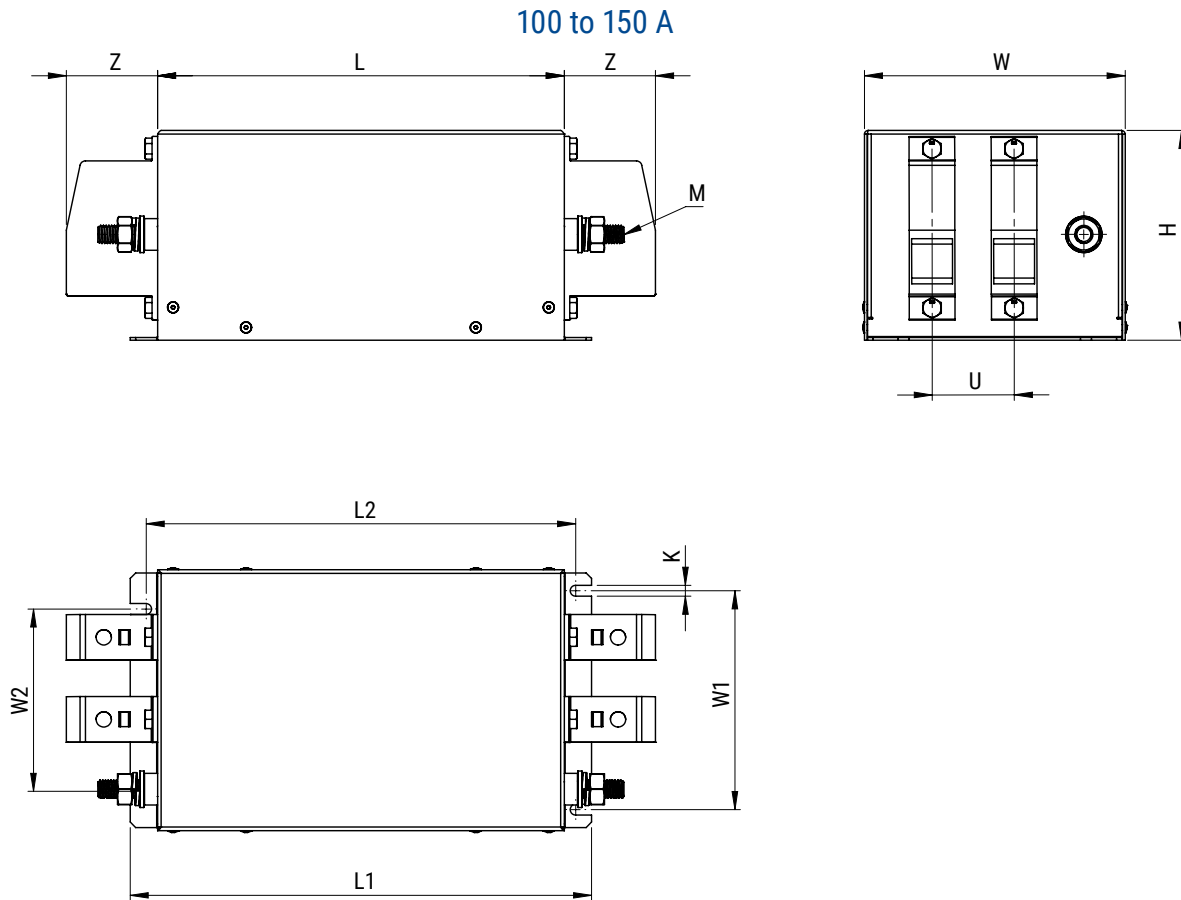

Part Number	Dimensions in mm											Terminal block	
	L	L1	L2	W	W1	W2	H	U	Z	K	M	Wire	Torque
													(mm ²)
FLLE2025AP(*)T3	140	170	153	80	50	60	65	25	15	5.5	M5	1 – 10	1.2 – 1.5
FLLE2050AP(*)T5	170	200	183	95	60	75	80	37	19	6.5	M6	10 – 25	3 – 4
FLLE2075AP(*)T5	170	200	183	95	60	75	80	37	19	6.5	M6	10 – 25	3 – 4
FLLE2100AP(*)T6	190	220	203	125	90	100	95	40	43	6.5	M8	16 – 50	6 – 8
FLLE2150AP(*)T7	220	250	233	140	100	120	115	45	50	6.5	M10	35 – 95	15 – 20

(*) To complete KEMET part number, insert V = Standard, X = Without Y capacitors
 Tolerances, if not stated, according to ISO 2768-c.

Mechanical Dimensions – Millimeters cont.

250 to 1,000 A

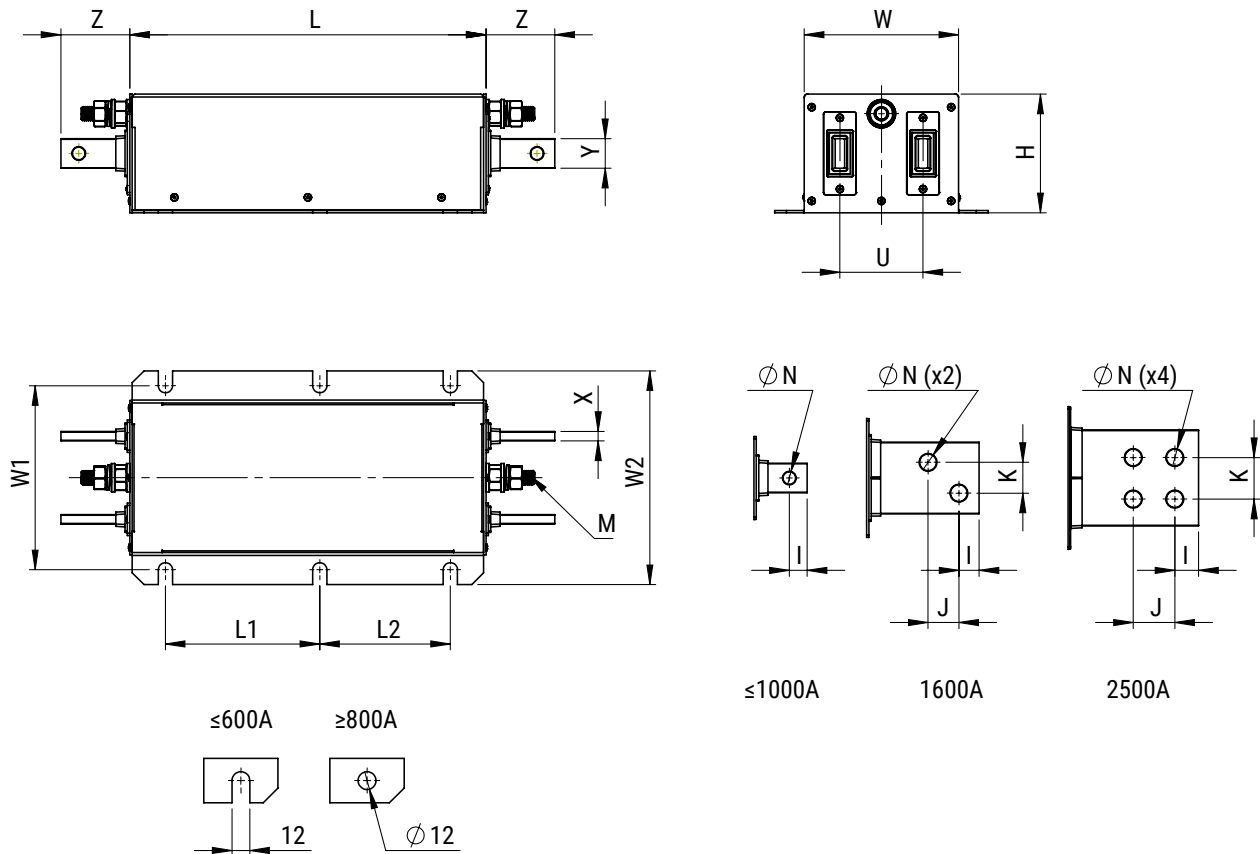

Part Number	Dimensions in mm															
	L	L1	L2	W	W1	W2	H	U	X	Y	Z	I	J	K	ØN	M
FLLE2250AP(*)I1	300	130	110	130	155	180	100	70	5	20	58	15	-	-	9	M10
FLLE2400AP(*)I1	300	130	110	130	165	190	100	70	6	25	58	15	-	-	10.5	M10
FLLE2600AP(*)I1	300	130	110	130	165	190	100	70	8	25	58	15	-	-	10.5	M10
FLLE2800AP(*)I1	300	130	110	150	175	200	130	70	8	40	65	20	-	-	14	M12
FLLE21K0AP(*)I1	300	130	110	150	175	200	130	70	8	40	65	20	-	-	14	M12
FLLE21K6AP(*)I1	300	130	110	150	175	200	130	70	10	60	110	17	43	26	14	M12
FLLE22K5AP(*)I1	400	190	150	190	225	250	180	100	15	80	100	20	35	35	14	M16

(*) To complete KEMET part number, insert V = Standard, X = Without Y capacitors
 Tolerances, if not stated, according to ISO 2768-c.

KEMET Electronics Corporation Sales Offices

For a complete list of our global sales offices, please visit www.kemet.com/sales.

Disclaimer

All product specifications, statements, information and data (collectively, the "Information") in this datasheet are subject to change. The customer is responsible for checking and verifying the extent to which the Information contained in this publication is applicable to an order at the time the order is placed. All Information given herein is believed to be accurate and reliable, but it is presented without guarantee, warranty, or responsibility of any kind, expressed or implied.

Statements of suitability for certain applications are based on KEMET Electronics Corporation's ("KEMET") knowledge of typical operating conditions for such applications, but are not intended to constitute – and KEMET specifically disclaims – any warranty concerning suitability for a specific customer application or use. The Information is intended for use only by customers who have the requisite experience and capability to determine the correct products for their application. Any technical advice inferred from this Information or otherwise provided by KEMET with reference to the use of KEMET's products is given gratis, and KEMET assumes no obligation or liability for the advice given or results obtained.

Although KEMET designs and manufactures its products to the most stringent quality and safety standards, given the current state of the art, isolated component failures may still occur. Accordingly, customer applications which require a high degree of reliability or safety should employ suitable designs or other safeguards (such as installation of protective circuitry or redundancies) in order to ensure that the failure of an electrical component does not result in a risk of personal injury or property damage.

Although all product-related warnings, cautions and notes must be observed, the customer should not assume that all safety measures are indicated or that other measures may not be required.

KEMET is a registered trademark of KEMET Electronics Corporation.