

Type 2 surge protection plug - VAL-MS 580-ST - 2920434

Please be informed that the data shown in this PDF Document is generated from our Online Catalog. Please find the complete data in the user's documentation. Our General Terms of Use for Downloads are valid (<http://phoenixcontact.com/download>)



Type 2 surge protection plug with high-capacity varistor for VAL-MS base element, thermal monitoring, visual fault warning. Design: 580 V AC

Your advantages

- ✓ Single-channel, DIN-rail mountable protective devices
- ✓ Base element with/without floating remote indication contact
- ✓ Disconnect device on each individual plug
- ✓ Consists of base element and plug
- ✓ Optical, mechanical status indication for the individual arresters
- ✓ Mechanical coding of all slots



Key Commercial Data

Packing unit	10 pc
GTIN	 4 046356 163682
GTIN	4046356163682

Technical data

Dimensions

Height	52.4 mm
Width	17.5 mm
Depth	55.3 mm
Horizontal pitch	1 Div.

Ambient conditions

Degree of protection	IP20
Ambient temperature (operation)	-40 °C ... 80 °C
Ambient temperature (storage/transport)	-40 °C ... 80 °C
Altitude	≤ 2000 m (amsl (above mean sea level))

Type 2 surge protection plug - VAL-MS 580-ST - 2920434

Technical data

Ambient conditions

Permissible humidity (operation)	5 % ... 95 %
Shock (operation)	25g (Half-sine / 11 ms / 3x ±X, ±Y, ±Z)
Vibration (operation)	5g (10 ... 500 Hz / 2.5 h / X, Y, Z)

General

IEC test classification	II
	T2
EN type	T2
IEC power supply system	TN
	IT
Mode of protection	L-PE
	L-PEN
Mounting type	on base element
Color	jet black RAL 9005
Housing material	PA 6.6
Degree of pollution	2
Distance between live and grounded parts	5 mm
Flammability rating according to UL 94	V-0
Type	Male
Number of positions	1
Surge protection fault message	optical

Additional descriptions

Note	For use in all low-voltage systems between L-PEN. Only for use in IT systems between L-PE if the bodies of the equipment in the low-voltage system are connected to the grounding system of the transformer station. (common grounding of the HV transformer station and the bodies of the LV consumer's installation. $R_E = R_A$ according to IEC 60364-4-442/VDE 0100-442 Figure 44D/example a)
------	---

Protective circuit

Nominal voltage U_N	400/690 V AC (TN)
	500 V AC (IT)
Nominal frequency f_N	50 Hz (60 Hz)
Maximum continuous voltage U_C	580 V AC
Residual current I_{PE}	≤ 0.25 mA
Standby power consumption P_C	≤ 150 mVA
Nominal discharge current I_n (8/20) μ s	15 kA
Maximum discharge current I_{max} (8/20) μ s	30 kA
Short-circuit current rating I_{SCCR}	25 kA
Voltage protection level U_p	≤ 2.5 kV
Residual voltage U_{res}	≤ 2.5 kV (at I_n)
	≤ 2.3 kV (at 10 kA)

Type 2 surge protection plug - VAL-MS 580-ST - 2920434

Technical data

Protective circuit

	≤ 2.1 kV (at 5 kA)
	≤ 1.9 kV (at 3 kA)
TOV behavior at U_T	690 V AC (5 s / withstand mode)
	762 V AC (120 min / withstand mode)
Response time t_A	≤ 25 ns
Max. backup fuse with branch wiring	125 A (gG)

Connection data

Connection method	pluggable
-------------------	-----------

UL specifications

SPD Type	4CA
Maximum continuous operating voltage MCOV (L-N)	580 V AC
Nom. voltage	400 V AC
Mode of protection	L-N
Power distribution system	Single phase
Nominal frequency	50/60 Hz
Measured limiting voltage MLV (L-N)	2310 V
Nominal discharge current I_n (L-N)	10 kA

Standards and Regulations

Standards/regulations	IEC 61643-11 2011
	EN 61643-11 2012

Environmental Product Compliance

China RoHS	Environmentally friendly use period: unlimited = EFUP-e
	No hazardous substances above threshold values

Drawings

Type 2 surge protection plug - VAL-MS 580-ST - 2920434

Circuit diagram



Type 2 surge protection plug - VAL-MS 580-ST - 2920434

Dimensional drawing

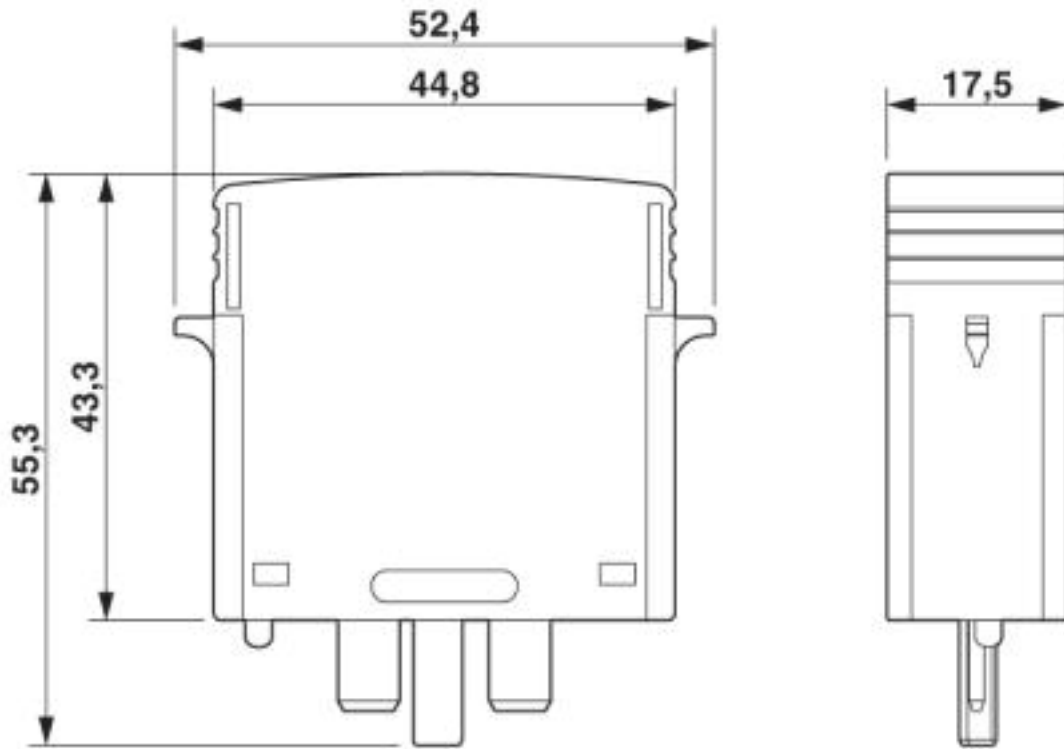

Approvals

Approvals

Approvals

CSA / CCA / UL Recognized / KEMA-KEUR / cUL Recognized / IECCE CB Scheme / ÖVE / EAC / cULus Recognized

Ex Approvals

Approval details







CSA		http://www.csagroup.org/services-industries/product-listing/	13631
-----	--	---	-------

CCA			NTR-AT 1947-A
-----	--	--	---------------

UL Recognized		http://database.ul.com/cgi-bin/XYV/template/LISEXT/1FRAME/index.htm	FILE E 330181
---------------	--	---	---------------

Type 2 surge protection plug - VAL-MS 580-ST - 2920434

Approvals

KEMA-KEUR		http://www.dekra-certification.com	2170208.01
cUL Recognized		http://database.ul.com/cgi-bin/XYV/template/LISEXT/1FRAME/index.htm	FILE E 330181
IECEE CB Scheme		http://www.iecee.org/	AT 2905/M1
ÖVE		https://www.ove.at/zertifizierung-pz/zertifizierungsregister/	18583-001-14
EAC			RU C- DE.A*30.B01561
cULus Recognized			

Phoenix Contact 2019 © - all rights reserved
<http://www.phoenixcontact.com>

PHOENIX CONTACT GmbH & Co. KG
Flachsmarktstr. 8
32825 Blomberg
Germany
Tel. +49 5235 300
Fax +49 5235 3 41200
<http://www.phoenixcontact.com>