

## Voltage Variable Absorptive Attenuator, 1700 - 2000 MHz

Rev. V2

### Features

- Input IP3: +31 dBm Min (Full Attenuation Range)
- Input IP3 is **15 -20 dB** Better than GaAs
- Linear Operation: +20 dBm Typ.
- 35 dB Dynamic Range (With 30 mA Bias Current)
- Single Control Voltage
- 50 ohm Impedance
- Linear Driver, MADR-007098-000100, Available
- Test Boards are Available
- Tape and Reel Packaging Available
- Lead-Free SOW-16 Package
- 100% Matte Tin Plating over Copper
- Halogen-Free “Green” Mold Compound
- 260°C Reflow Compatible
- RoHS\* Compliant Version of AT10-0017

### Description

M/A-COM's MAAV-007090-000100 is a PIN diode based voltage variable attenuator. This device is in a SOW-16, wide body plastic surface mount package. These attenuators have linear operating power and input intercept point levels 15 - 20 dB better than GaAs FET MMIC voltage variable attenuators. They are ideally suited for use where low distortion, high linear operating power and high dynamic range are required. These devices are optimized for the PCS frequency band, but exhibit excellent performance and repeatability over the entire specified frequency band. The MAAV-007090-000100 is ideally suited for wireless communications systems.

### Ordering Information

Part Number	Package
MAAV-007090-000100	Tube
MAAV-007090-0001TR	1000 piece reel
MAAV-007090-0001TB	Unit Mounted on Test Board
MAAV-007090-DR01TB	Unit with Driver on Test Board

Note: Reference Application Note M513 for reel size information.

### Functional Schematic

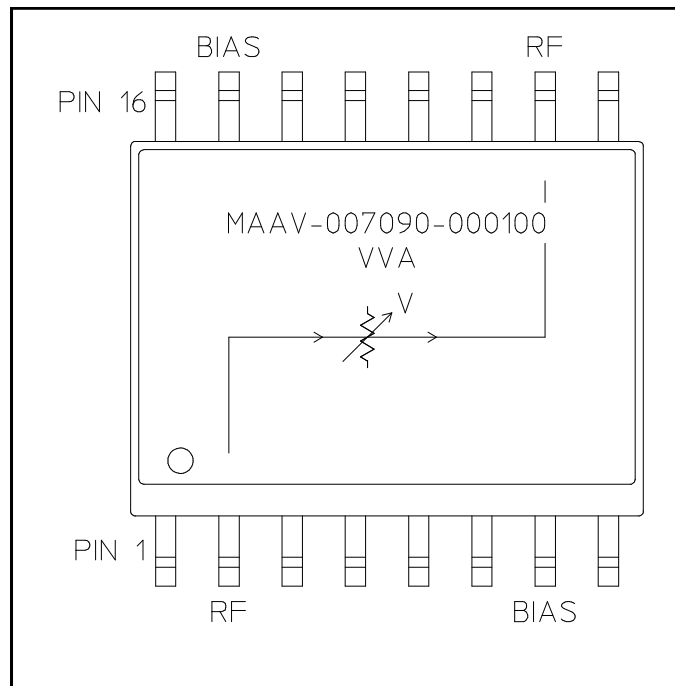

### Pin Configuration

Pin No.	Function	Pin No.	Function
1	GND	9	GND
2	RF	10	RF
3	GND	11	GND
4	GND	12	GND
5	GND	13	GND
6	GND	14	GND
7	BIAS <sup>1</sup>	15	BIAS <sup>1</sup>
8	GND	16	GND

1. Bias currents may be applied to pin 7 or 15. The unused pins should be isolated.

\* Restrictions on Hazardous Substances, European Union Directive 2002/95/EC.

## Voltage Variable Absorptive Attenuator, 1700 - 2000 MHz

Rev. V2

### Electrical Specifications: $T_A = 25^\circ\text{C}$ , $Z_0 = 50\Omega$

Parameter	Test Conditions	Frequency	Units	Min	Typ	Max
Insertion Loss	0 volts	1700-2000 MHz	dB	—	—	3.5
		1930 - 1990 MHz	dB	—	2.5	3.0
Attenuation (Above Loss)	10 mA bias current	1700-2000 MHz	dB	28	—	—
		1930 - 1990 MHz	dB	30	35	—
Attenuation Flatness	0 to 30 dB attenuation	1700-2000 MHz	dB	—	1.5	2.0
		1930 - 1990 MHz	dB	—	0.4	0.6
VSWR	0 to 30 dB attenuation	1700-2000 MHz	Ratio	—	1.6:1	1.8:1
		1930 - 1990 MHz	Ratio	—	1.5:1	1.7:1
Switching Speed	50% Control to 90%/10% RF	1700-2000 MHz	$\mu\text{s}$	—	—	3.0
Linear Operation	—	1700-2000 MHz	dBm	—	+20	—
Input $IP_3$	Two-tone inputs up to +10 dBm	1700-2000 MHz	dBm	+31	—	—
$I_{\text{Control}}$	—	1700-2000 MHz	mA	—	—	30

### Absolute Maximum Ratings <sup>2,3</sup>

Parameter	Absolute Maximum
Max. Input Power 1700 - 2000 MHz	+27 dBm
Operating Temperature	-40°C to +85°C
Storage Temperature	-65°C to +125°C

- Exceeding any one or combination of these limits may cause permanent damage to this device.
- M/A-COM does not recommend sustained operation near these survivability limits.

### Handling Procedures

Please observe the following precautions to avoid damage:

### Static Sensitivity

Gallium Arsenide Integrated Circuits are sensitive to electrostatic discharge (ESD) and can be damaged by static electricity. Proper ESD control techniques should be used when handling these devices.

### Recommended PCB Configuration

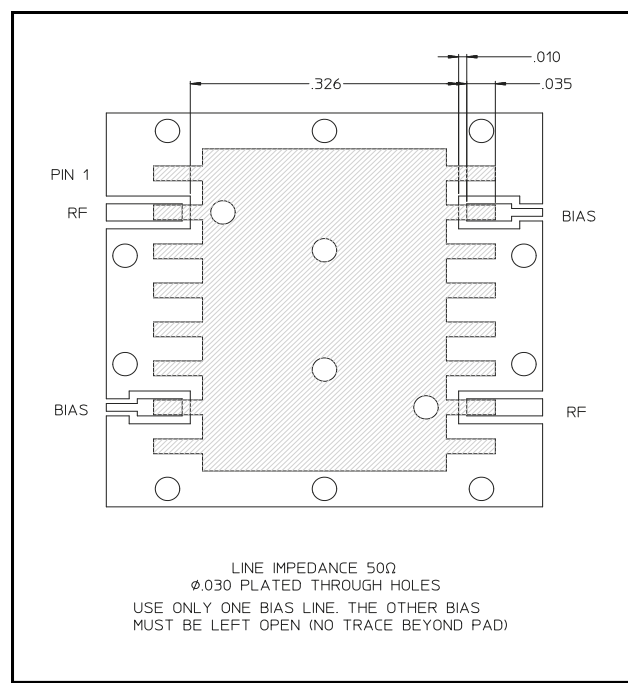

## Typical Performance Curves

*Insertion Loss*

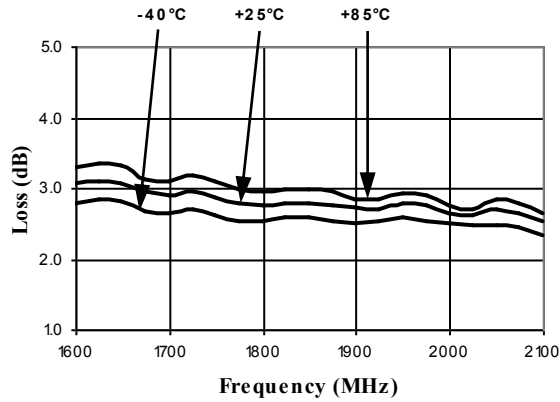

*Attenuation Flatness (dB) @ +25°C*

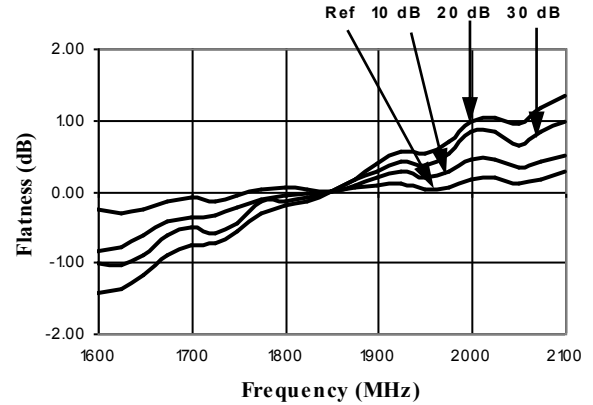

*Typical VSWR @ +25°C*

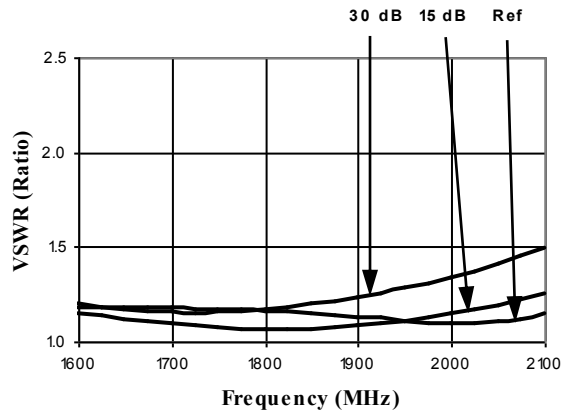

*Attenuation vs. Bias Current,  
Frequency = 2000 MHz*

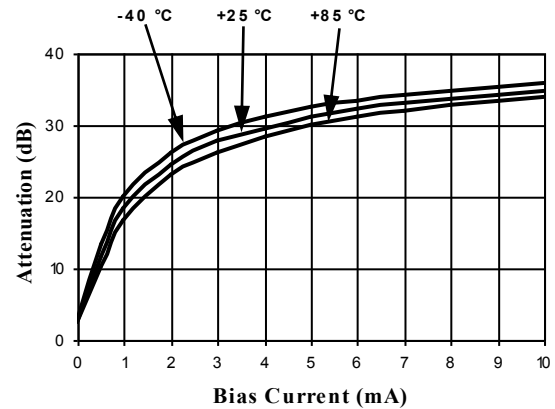

## Voltage Variable Absorptive Attenuator, 1700 - 2000 MHz

Rev. V2

### Lead-Free, SOW-16<sup>†</sup>

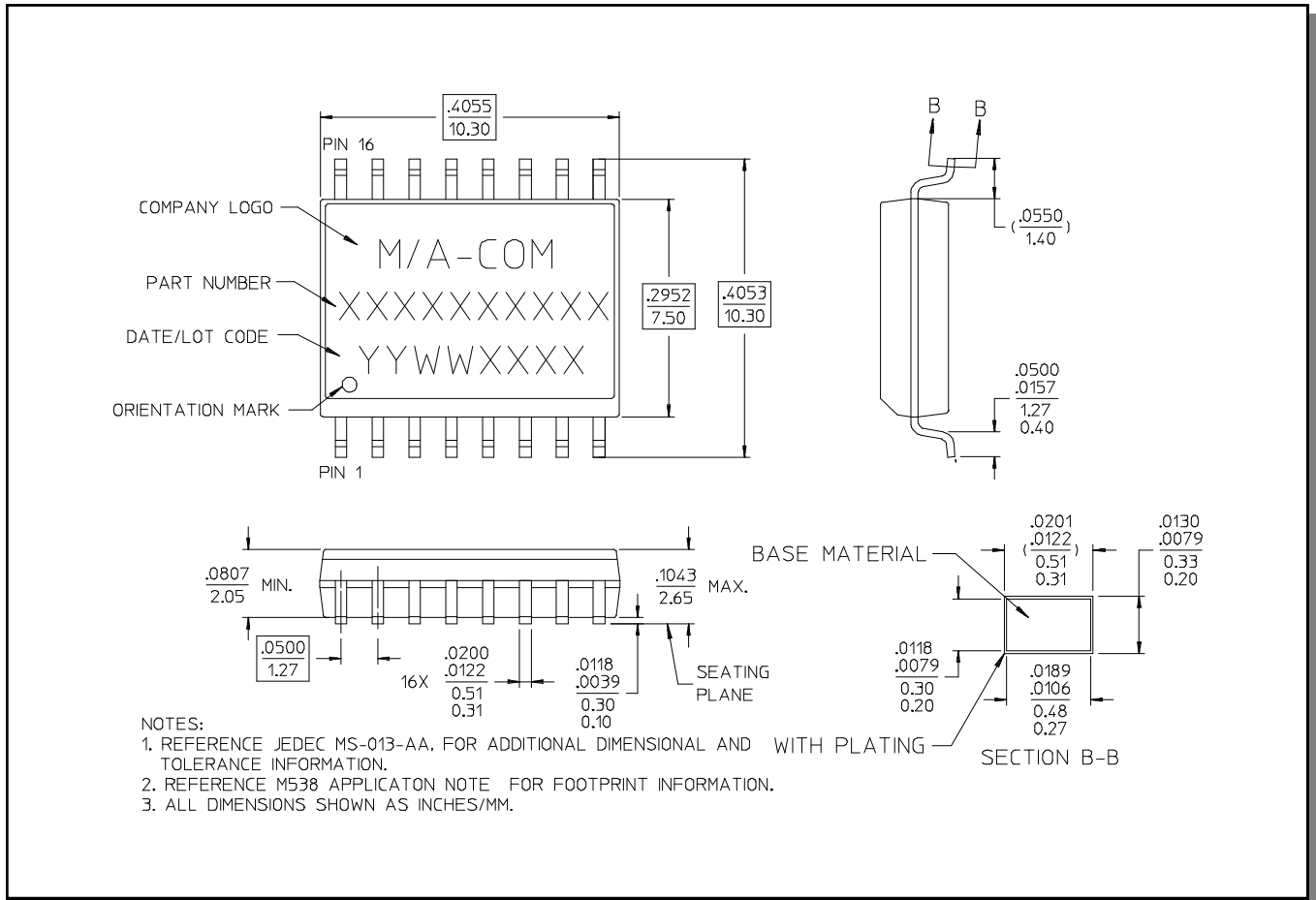

<sup>†</sup> Reference Application Note M538 for lead-free solder reflow recommendations.

M/A-COM Technology Solutions Inc. All rights reserved.

Information in this document is provided in connection with M/A-COM Technology Solutions Inc ("MACOM") products. These materials are provided by MACOM as a service to its customers and may be used for informational purposes only. Except as provided in MACOM's Terms and Conditions of Sale for such products or in any separate agreement related to this document, MACOM assumes no liability whatsoever. MACOM assumes no responsibility for errors or omissions in these materials. MACOM may make changes to specifications and product descriptions at any time, without notice. MACOM makes no commitment to update the information and shall have no responsibility whatsoever for conflicts or incompatibilities arising from future changes to its specifications and product descriptions. No license, express or implied, by estoppel or otherwise, to any intellectual property rights is granted by this document.

THESE MATERIALS ARE PROVIDED "AS IS" WITHOUT WARRANTY OF ANY KIND, EITHER EXPRESS OR IMPLIED, RELATING TO SALE AND/OR USE OF MACOM PRODUCTS INCLUDING LIABILITY OR WARRANTIES RELATING TO FITNESS FOR A PARTICULAR PURPOSE, CONSEQUENTIAL OR INCIDENTAL DAMAGES, MERCHANTABILITY, OR INFRINGEMENT OF ANY PATENT, COPYRIGHT OR OTHER INTELLECTUAL PROPERTY RIGHT. MACOM FURTHER DOES NOT WARRANT THE ACCURACY OR COMPLETENESS OF THE INFORMATION, TEXT, GRAPHICS OR OTHER ITEMS CONTAINED WITHIN THESE MATERIALS. MACOM SHALL NOT BE LIABLE FOR ANY SPECIAL, INDIRECT, INCIDENTAL, OR CONSEQUENTIAL DAMAGES, INCLUDING WITHOUT LIMITATION, LOST REVENUES OR LOST PROFITS, WHICH MAY RESULT FROM THE USE OF THESE MATERIALS.

MACOM products are not intended for use in medical, lifesaving or life sustaining applications. MACOM customers using or selling MACOM products for use in such applications do so at their own risk and agree to fully indemnify MACOM for any damages resulting from such improper use or sale.