

Device Features

- Single Fixed 3.3V supply
- Gain = 14.0 dB @ 3500MHz
- Output P1 dB = 14.0 dBm @ 3500MHz
- 5G NR ACLR = 2.5 dBm @ 3500MHz
- Internally matched to 50 ohms
- RoHS2-compliant SOT-363 SMT package

Product Description

The BGH5 is a BroadBand, HBT Amplifier that is ideal for applications demanding high linearity in a wideband of 40-6000 MHz. The BGH5 is internally matched to 50 Ohms and requires no external matching components. It is available in RoHS2-compliant SOT363 SMT package. These devices are 100% DC and RF tested to assure quality and performance.

Applications

- Mobile Infrastructure
- LTE / WCDMA / EDGE / 5G NR / WIFI
- General Purpose Wireless

Applications Circuit

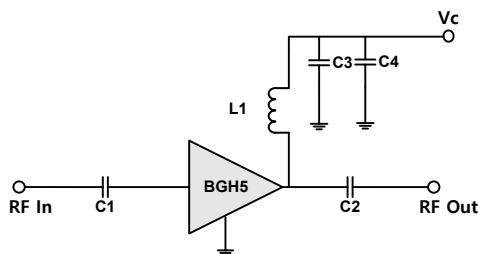

Application Circuit Values Example		
Freq.	0.04 ~ 1GHz	1 ~6GHz
C1	1 nF	10 pF
C2	1 nF	4 pF
C3	100 pF	100 pF
C4	1 nF	1 nF
L1	1 uH	15 nH

Part Marking (XX:Wafer number)

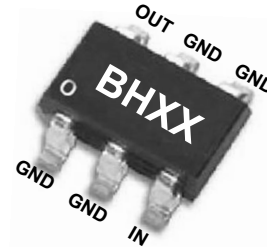

Pin Description	
RF IN	3
RF OUT	6
GND	1,2,4,5

Electrical Specifications

Device performance _ measured on a BeRex evaluation board at 25°C, Vc=3.3V, 50 Ω system.

Parameter	Conditions	Min	Typ	Max	Unit
Operational Frequency Range		40		6000	MHz
Test Frequency			3500		MHz
Gain		12.5	14.0		dB
Input Return Loss			-16.5		dB
Output Return Loss			-11.5		dB
Output IP3	0 dBm / tone , Δf=1 MHz	23.0	26.0		dBm
Output P1dB		13.0	14.0		dBm
5G NR ACLR*		1.5	2.5		dBm
Noise Figure			3.3		dB

*ACLR Channel Power measured at -50dBc.

- 5G set-up: 3GPP 5G NR, 100MHz BW, ±100MHz offset, PAR 9.5 at 0.01% Prob.

Recommended Operating Conditions

Parameter	Min	Typ	Max	Unit
Bandwidth	40		6000	MHz
Ic @ (Vc = 3.3V)	40	50	60	mA
Vc	3.0	3.3	3.6	V
dG/dT		0.01		dB/°C
RTH		52		°C/W
Operating Case Temperature	-40		+105	°C

Electrical specifications are measured at specified test conditions.

Specifications are not guaranteed over all recommended operating conditions.

Absolute Maximum Ratings

Parameter	Rating	Unit
Storage Temperature	-55 to +155	°C
Junction Temperature	140	°C
Supply Voltage	+4	V
Supply Current	130	mA
Input RF Power	27	dBm

Operation of this device above any of these parameters may result in permanent damage.

Typical Performance (Vc=3.3V, Ic=50mA, T=25°C)

Parameter	Frequency							Unit
	70	500	900	2140	3500	4500	5800	MHz
Gain	20.2	18.8	18.1	16.3	14.0	12.5	10.1	dB
S11	-11.8	-17.6	-17.6	-18.4	-16.5	-14.3	-10.9	dB
S22	-12.3	-13.9	-11.4	-13.3	-11.5	-10.2	-6.4	dB
OIP3	31.3	31.1	30.0	28.4	26.0	24.2	21.6	dBm
P1dB	14.1	14.3	14.4	15.3	14.0	12.4	10.4	dBm
LTE 20M ACLR*	5.4	5.4	5.4	5.1	-	-	-	dBm
5G NR ACLR*	-	-	-	-	2.5	1.0	-1.6	dBm
Noise Figure	3.0	3.2	3.1	3.3	3.3	3.5	4.0	dB

*ACLR Channel Power measured at -50dBc.

- LTE set-up: 3GPP LTE, FDD E-TM3.1, 20MHz BW, ±20MHz offset, PAR 9.75 at 0.01% Prob.

- 5G set-up: 3GPP 5G NR, 100MHz BW, ±100MHz offset, PAR 9.5 at 0.01% Prob.

V-I Characteristics

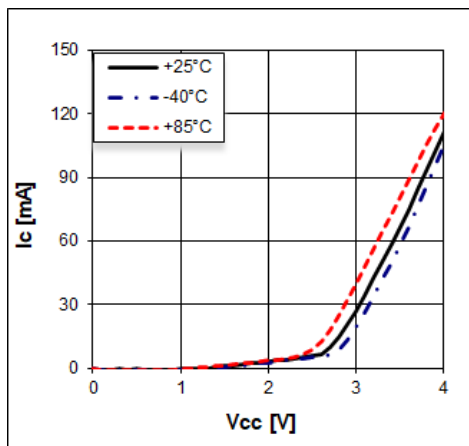

BeRex SOT-363 Evaluation Board

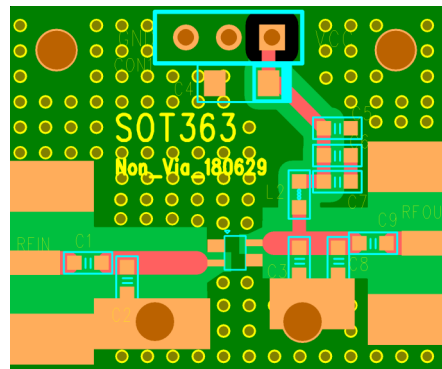

*Dielectric constant _ 4.2 *RF pattern width 52mil *31mil thick FR4

*Without vias under device degrade device performance.

Typical Device Data

S-parameters ($V_c=3.3V$, $I_c=50mA$, $T=25^\circ C$, Bias Tee Data)

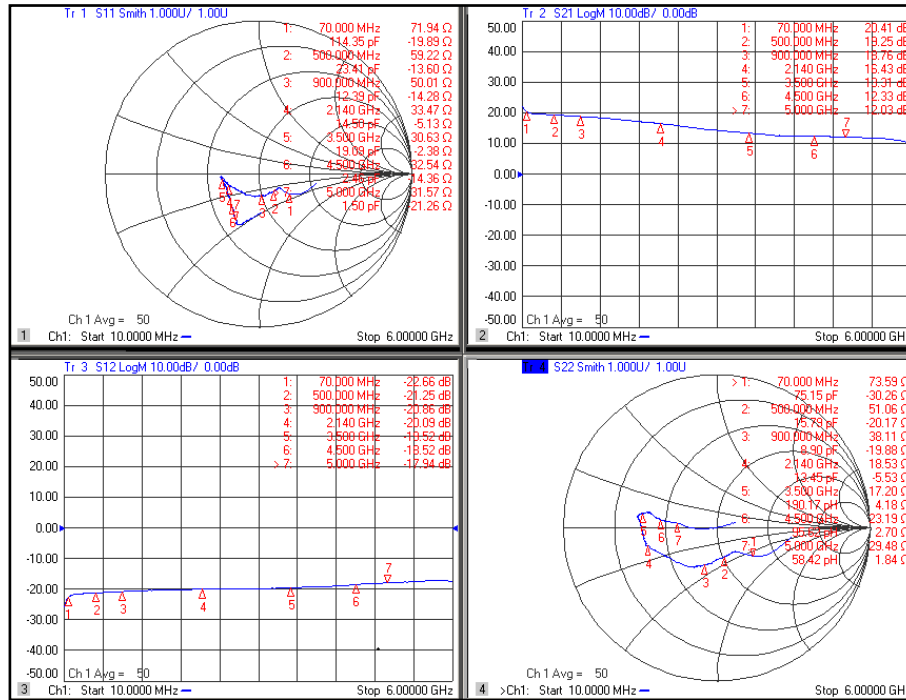

S-Parameter

($V_c = 3.3V$, $I_c = 50mA$, $T = 25^\circ C$, calibrated to device leads, Bias Tee Data)

Freq [MHz]	S11 Mag	S11 Ang	S21 Mag	S21 Ang	S12 Mag	S12 Ang	S22 Mag	S22 Ang
100	0.19	-34.35	9.98	168.89	0.08	10.07	0.25	-43.94
500	0.15	-50.03	9.17	155.55	0.09	4.67	0.20	-76.65
1000	0.14	-91.31	8.51	135.54	0.09	2.75	0.27	-115.17
1500	0.16	-124.20	7.69	116.00	0.10	-0.20	0.35	-141.04
2000	0.19	-154.34	6.84	97.88	0.10	-4.00	0.45	-162.06
2500	0.23	-170.55	5.89	80.51	0.10	-8.09	0.49	-175.87
3000	0.24	-175.82	5.15	66.49	0.10	-11.46	0.52	172.58
3500	0.24	-171.08	4.61	52.46	0.11	-15.89	0.49	169.17
4000	0.23	-153.05	4.21	41.95	0.11	-19.38	0.44	167.30
4500	0.27	-130.27	4.13	29.53	0.12	-24.90	0.36	172.28
5000	0.34	-116.06	3.99	16.84	0.13	-32.23	0.25	173.42
5500	0.35	-108.69	3.81	0.80	0.14	-43.10	0.11	-176.01
6000	0.25	-84.74	3.17	-16.44	0.14	-56.32	0.14	13.85

RF Application Circuit: 40 – 1000MHz

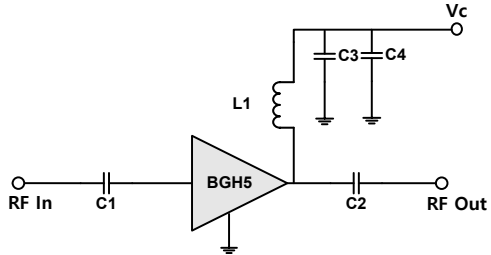
Schematic Diagram		BOM		Tolerance
	C1	1 nF	± 5%	
	C2	1 nF	± 5%	
	C3	100 pF	± 5%	
	C4	1 nF	± 5%	
	L1	1 uH	± 5%	

Typical Performance

$V_c = 3.3V, I_c = 50mA, T = 25^\circ C$

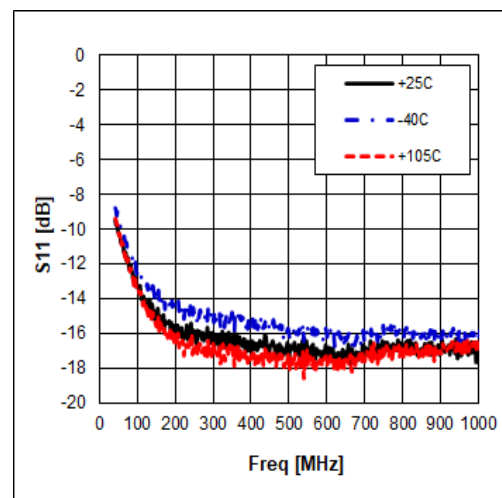
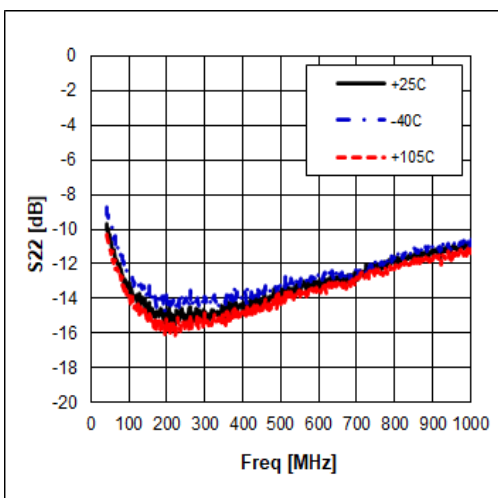
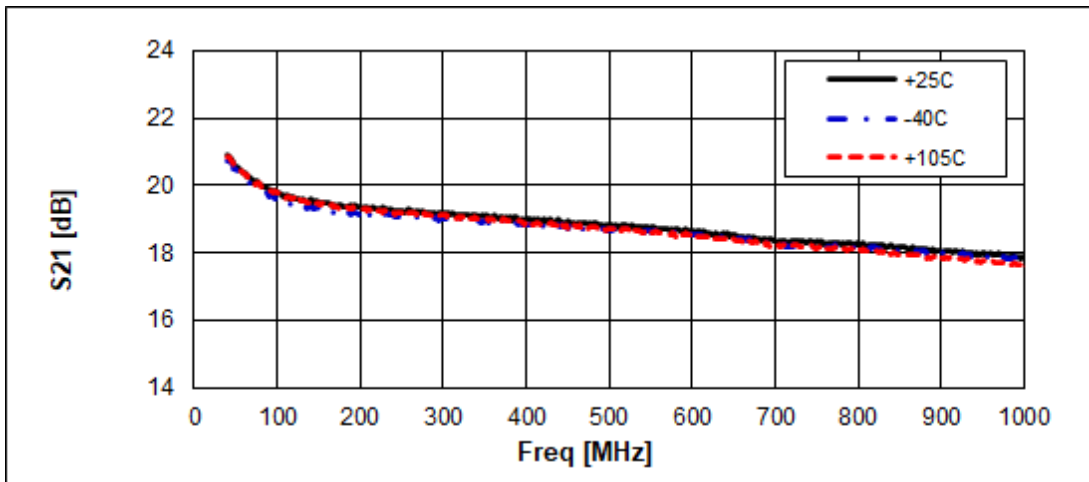

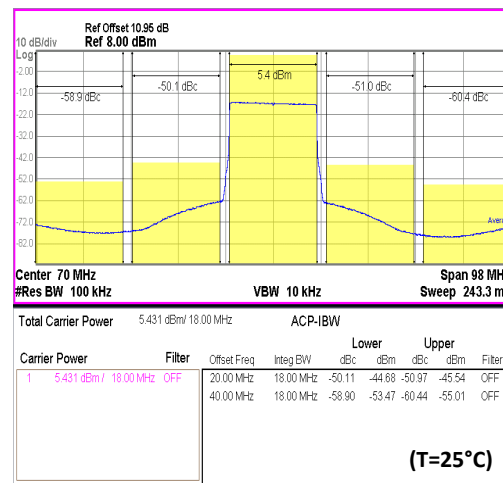
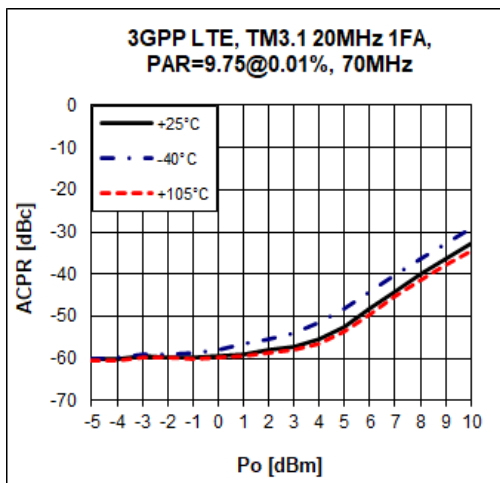
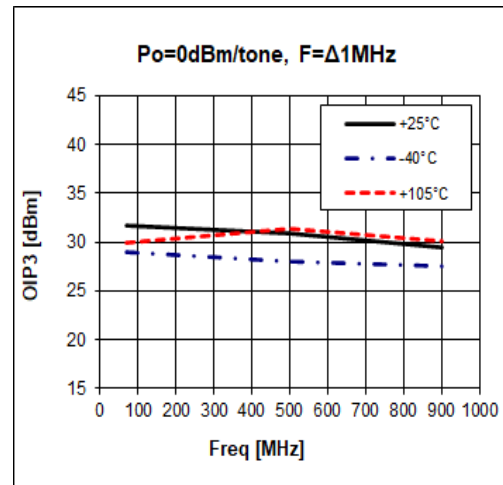
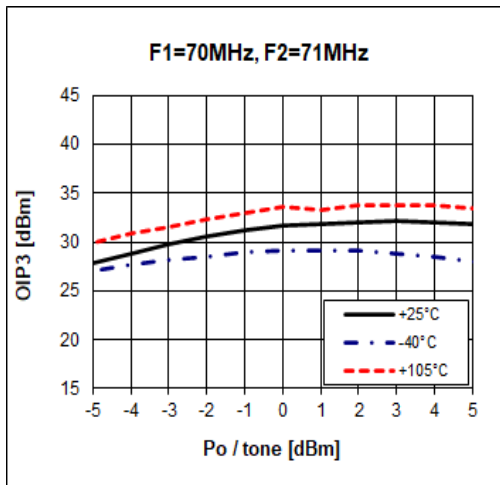
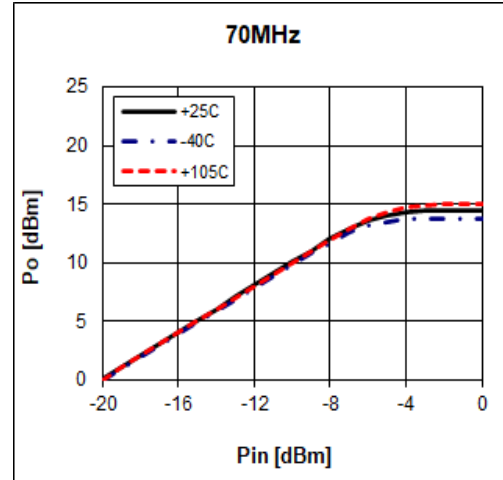
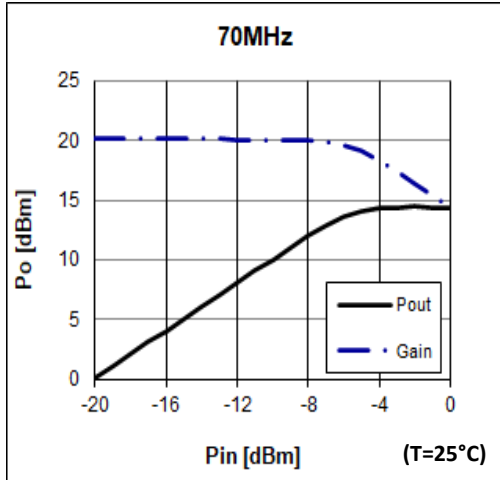

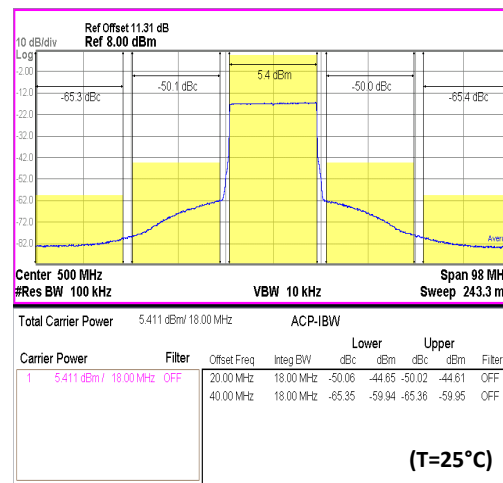
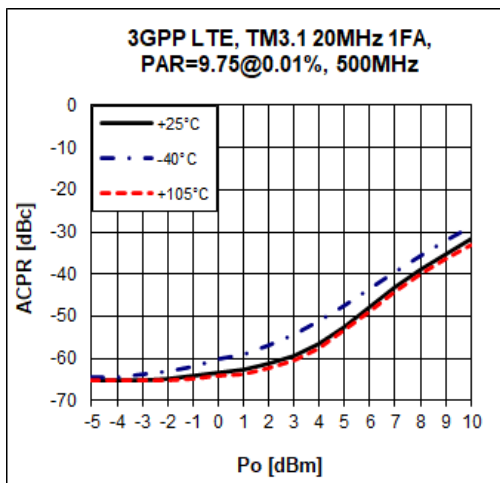
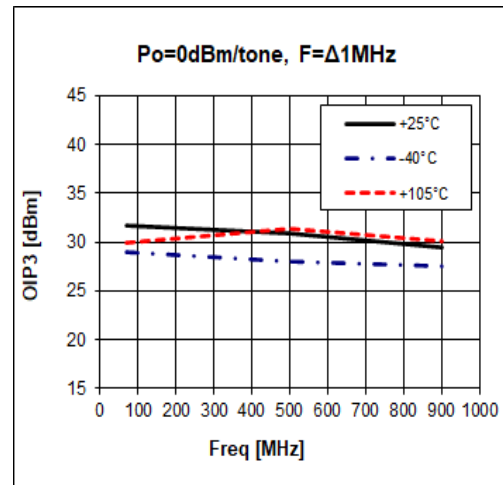
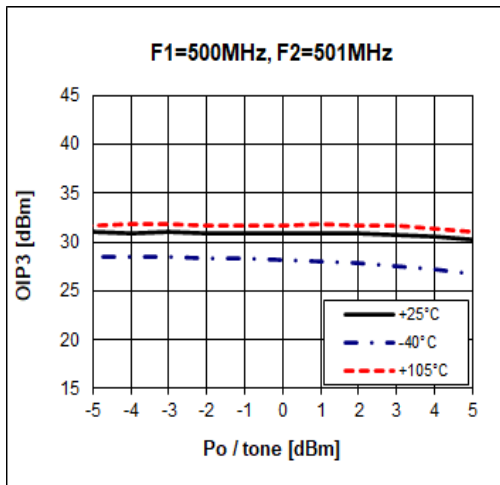
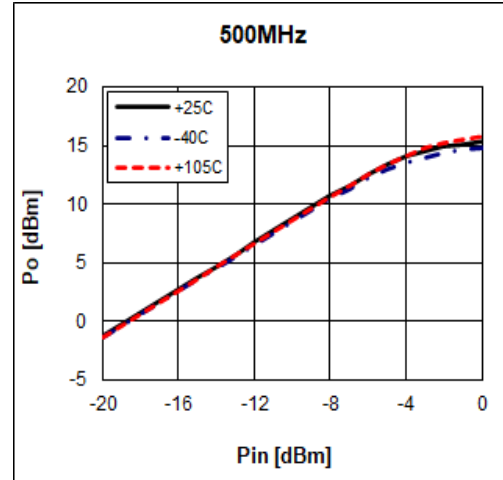
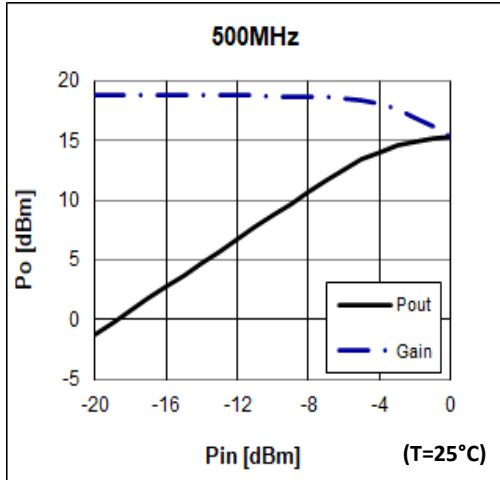

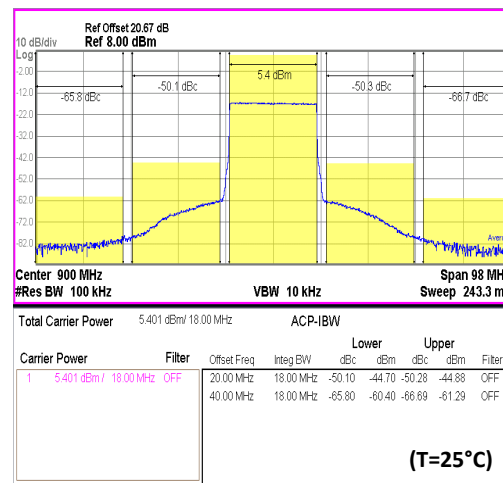
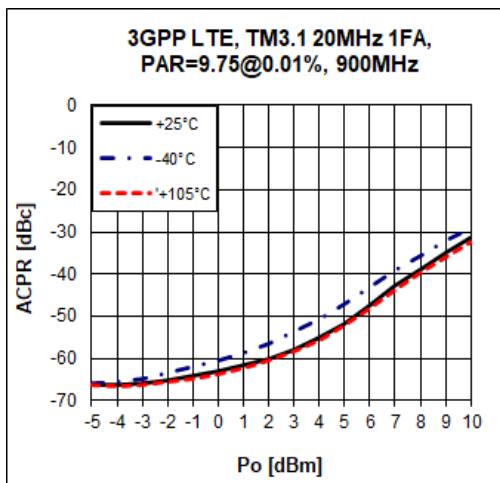
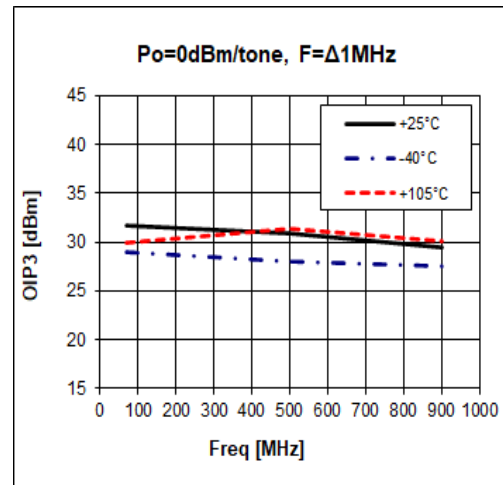
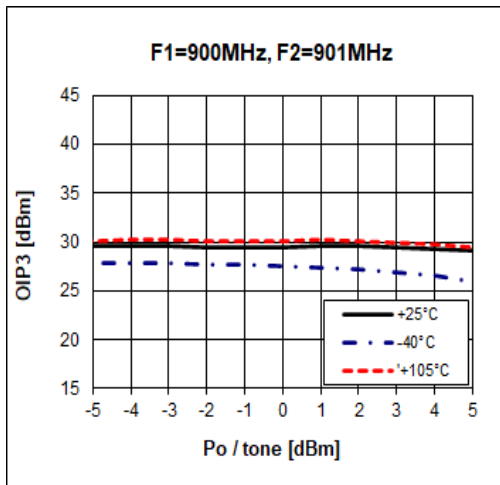
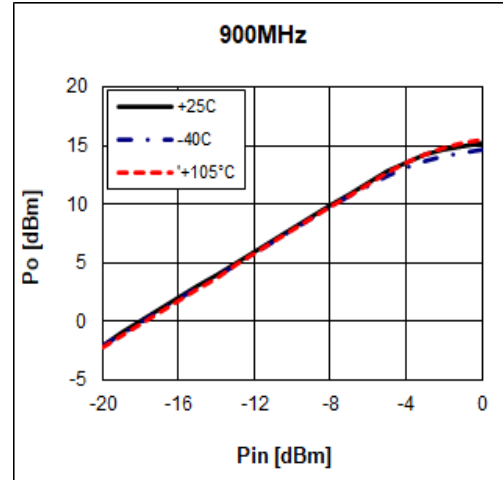
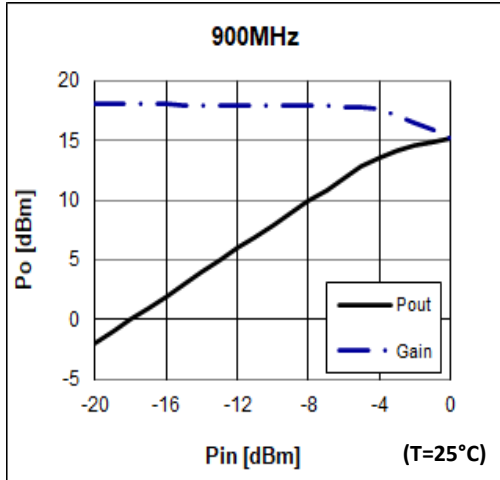

RF Application Circuit: 1000 – 6000MHz

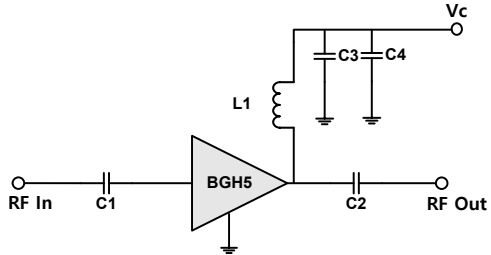
Schematic Diagram		BOM		Tolerance
		C1	10 pF	± 5%
		C2	4 pF	± 5%
		C3	100 pF	± 5%
		C4	1 nF	± 5%
		L1	15 nH	± 5%

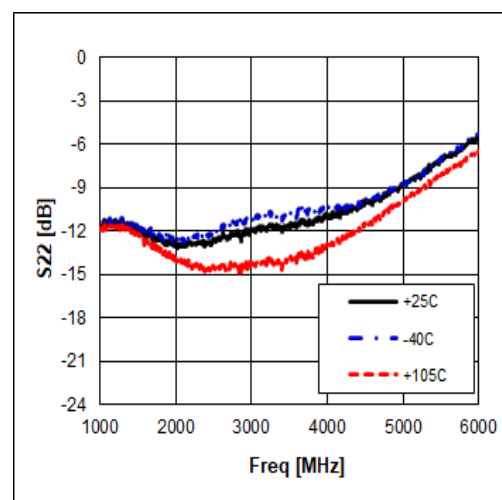
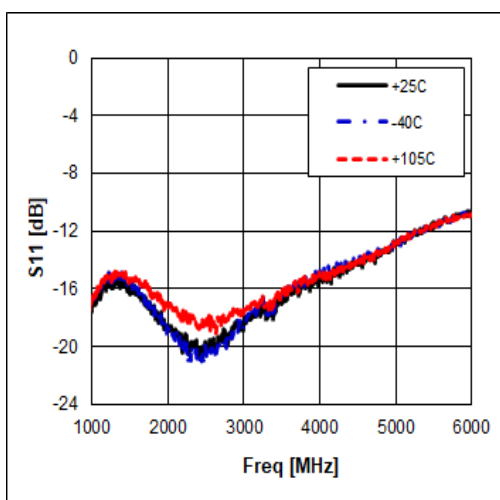
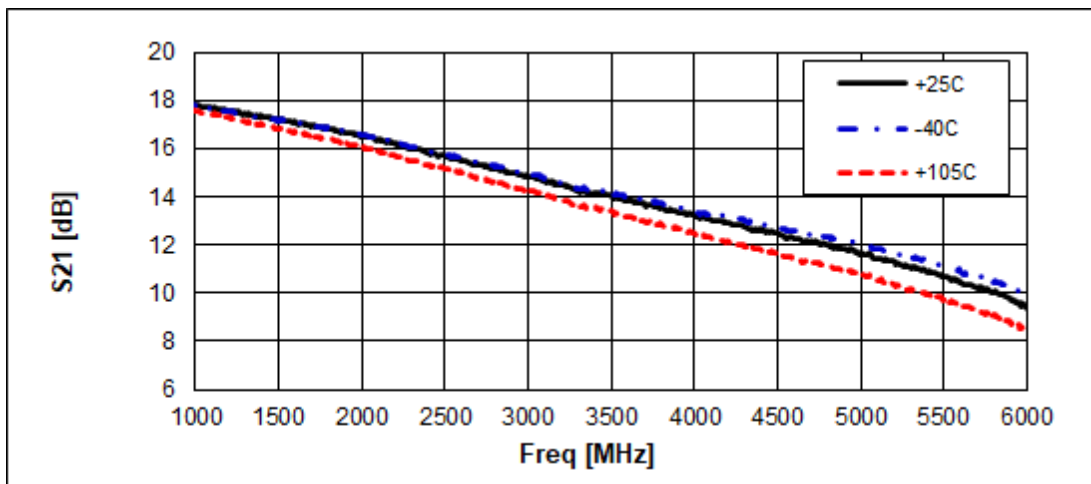
Typical Performance
 $V_c = 3.3V, I_c = 50mA, T = 25^\circ C$

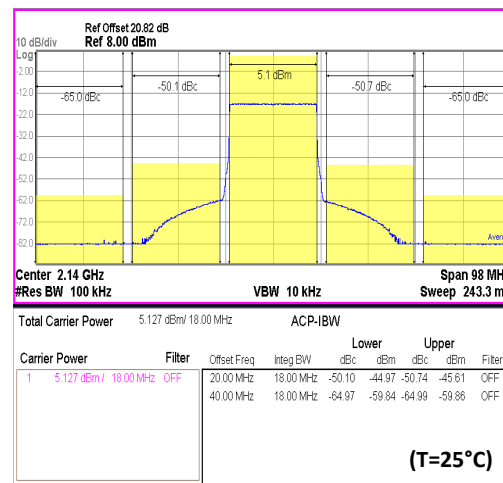
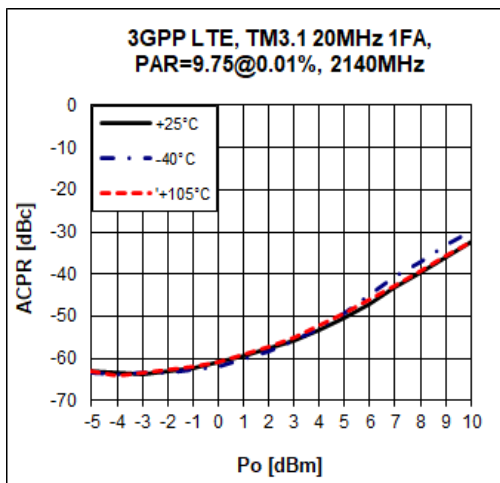
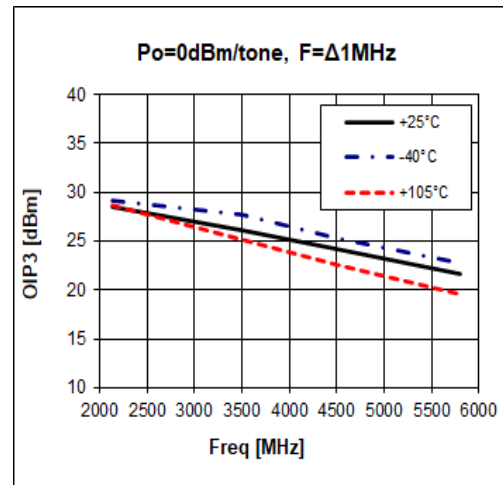
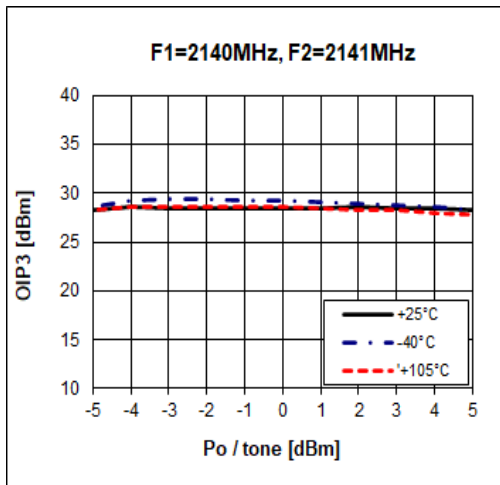
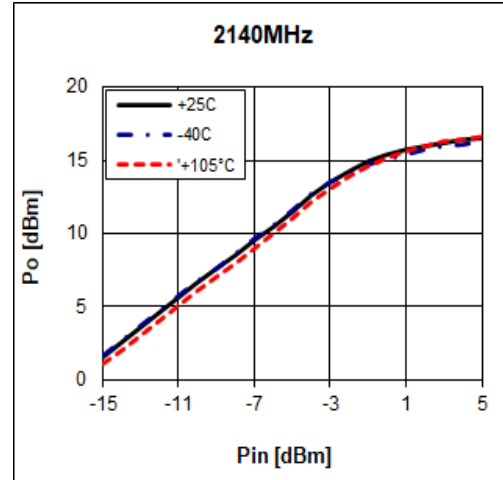
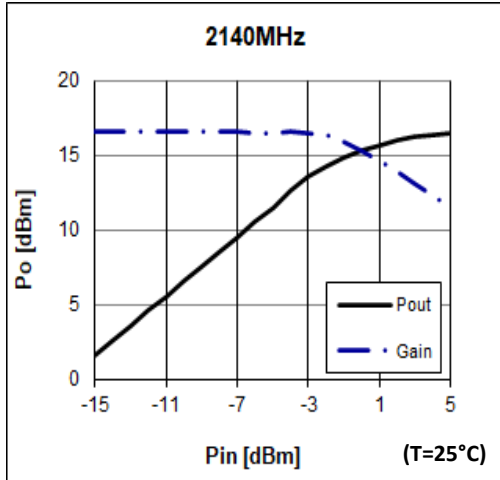

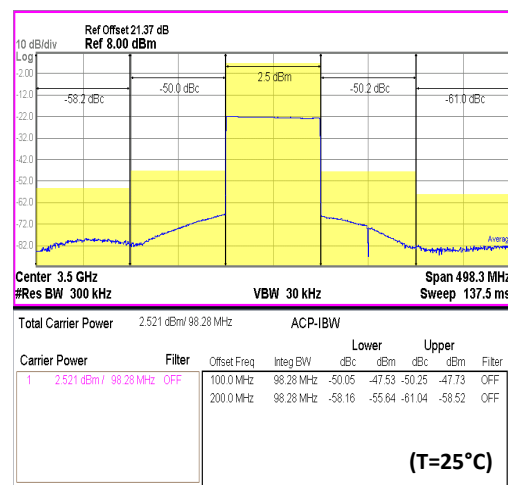
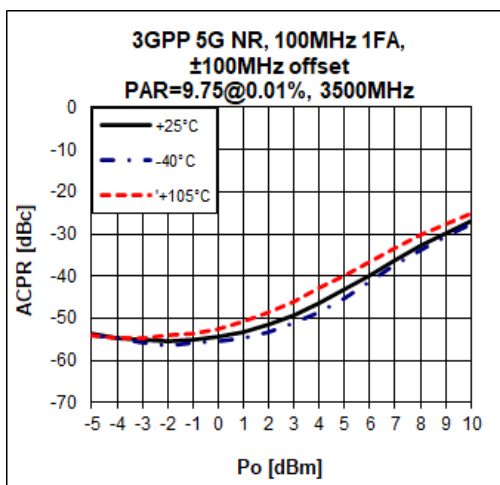
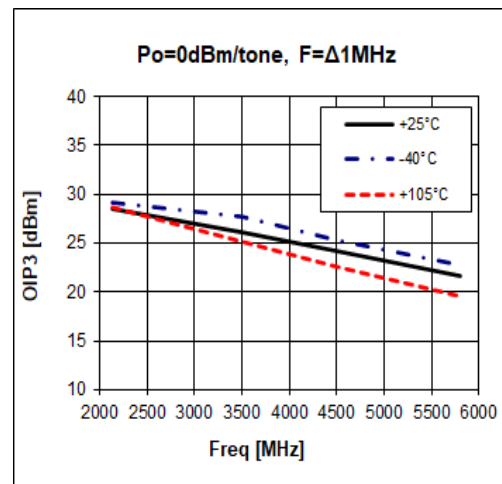
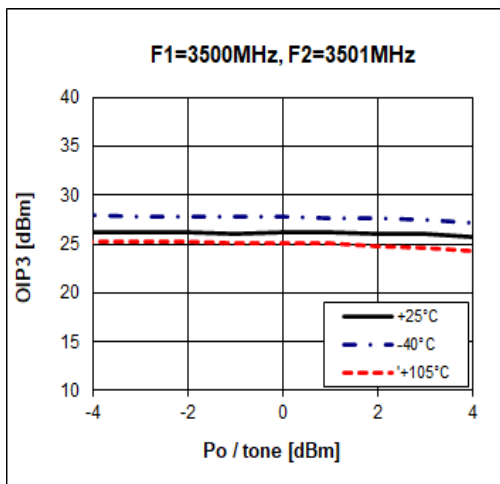
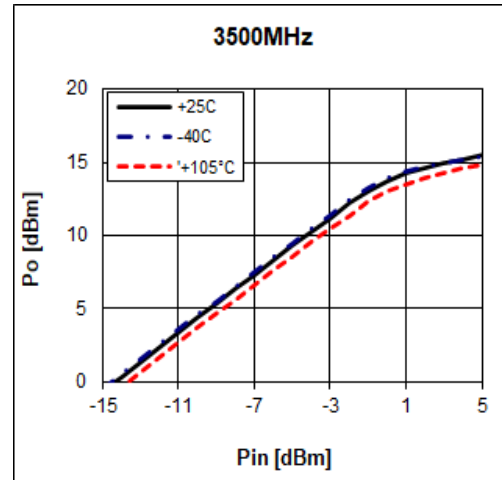
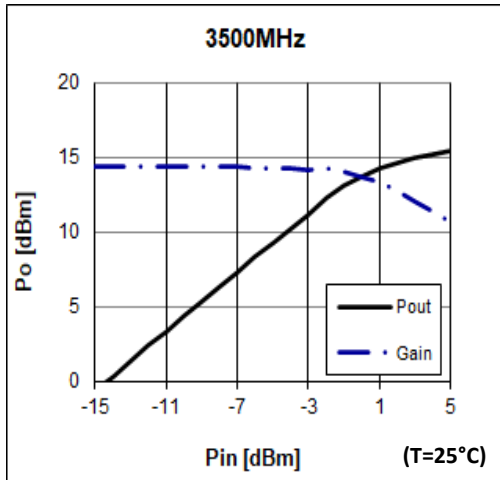

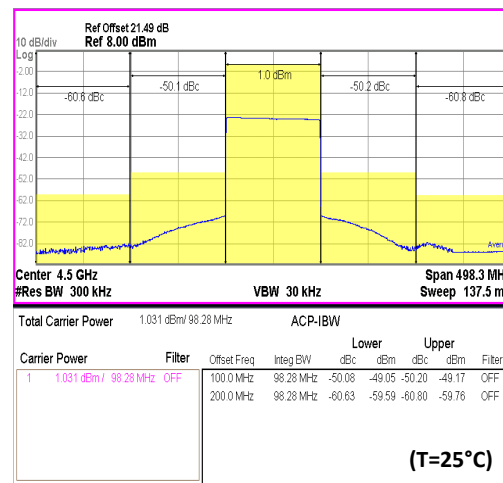
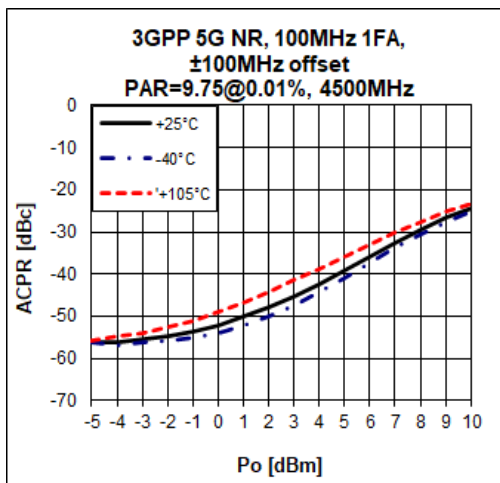
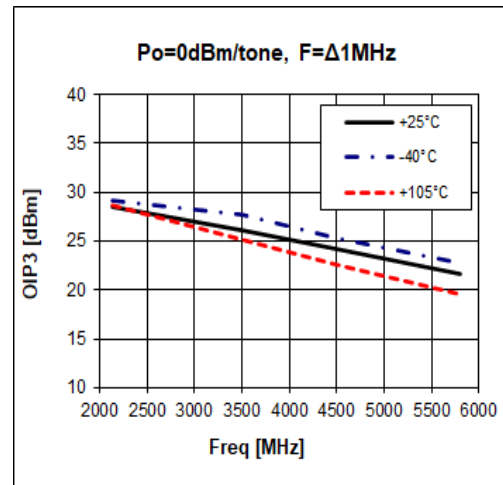
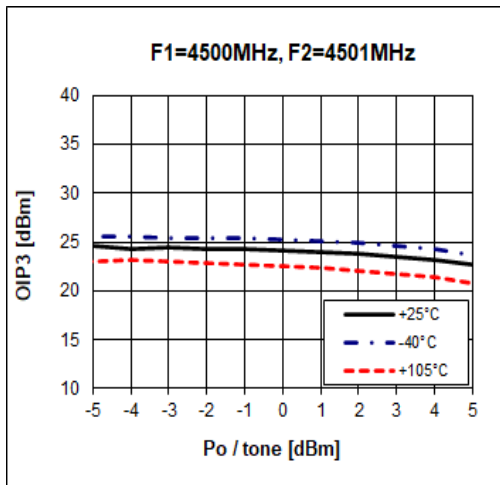
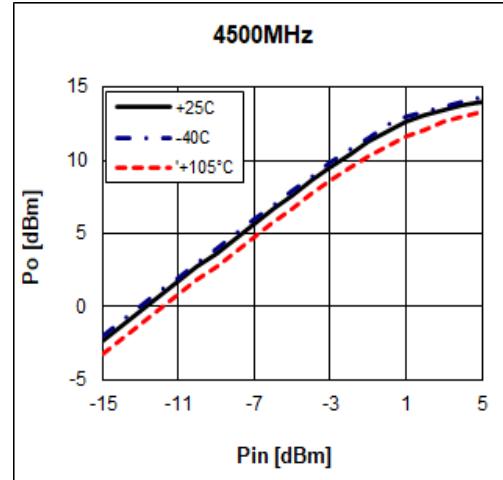
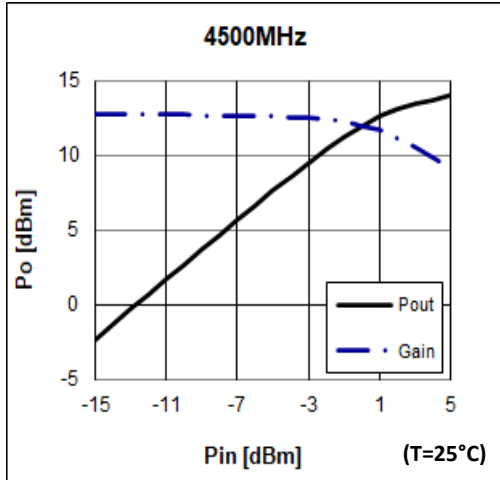

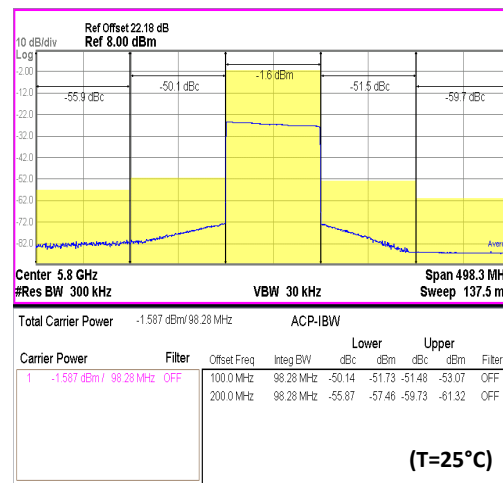
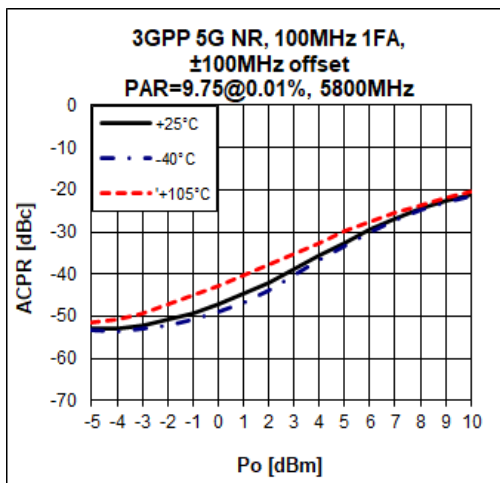
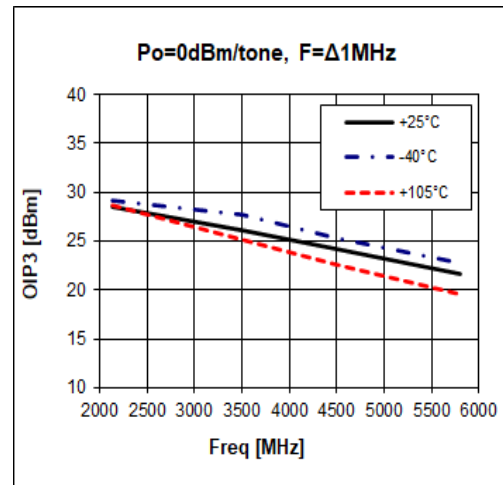
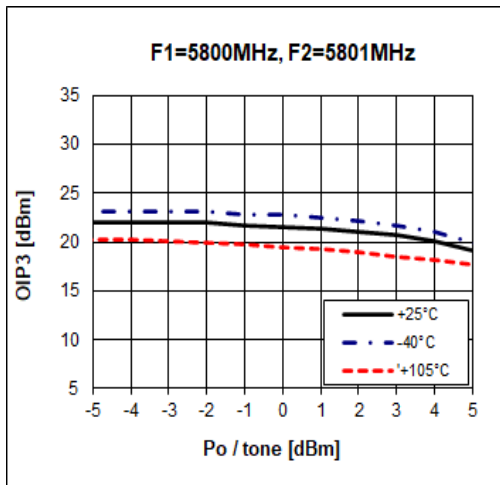
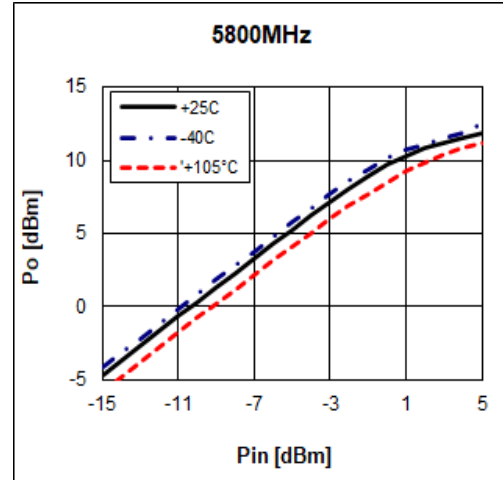
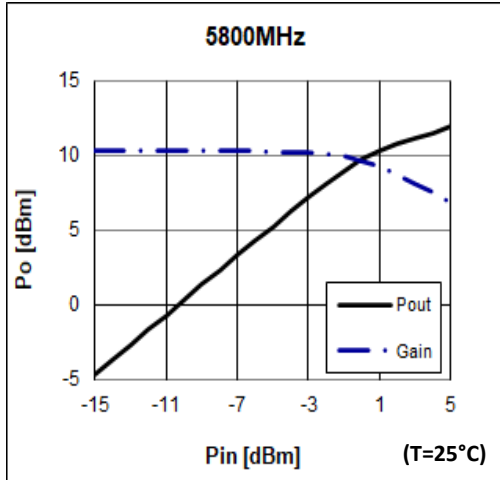

Package Outline Dimension

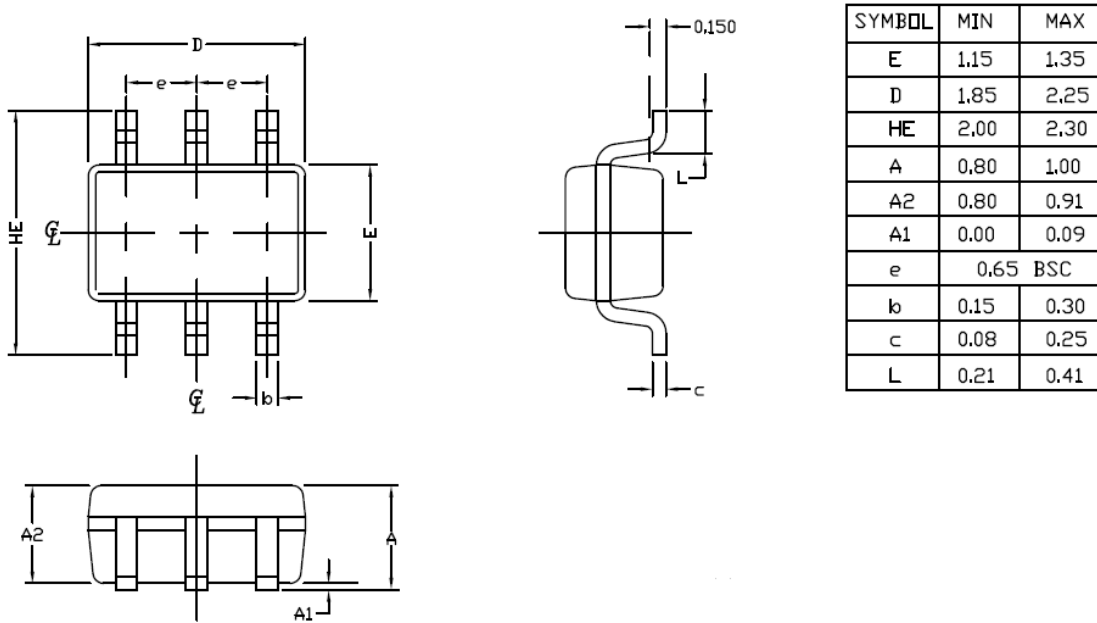

Suggested PCB Land Pattern and PAD Layout

PCB Land Pattern

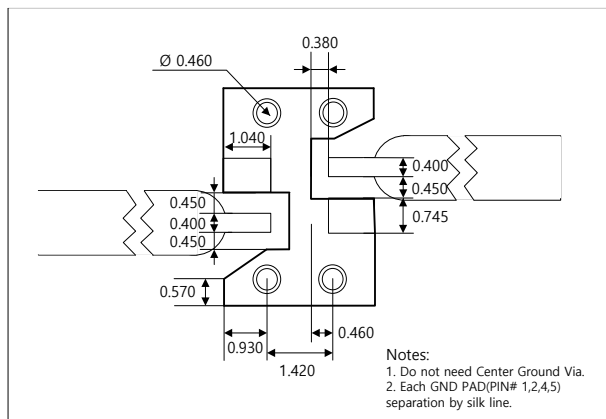

PCB Mounting

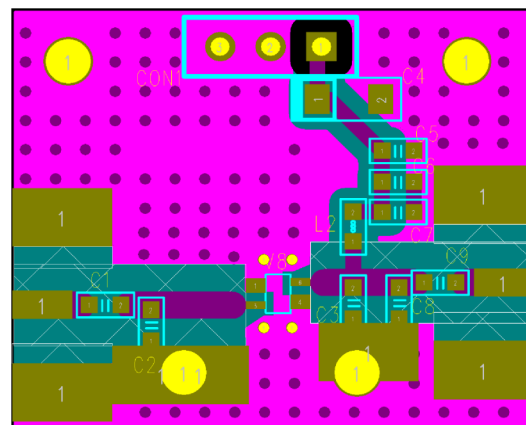

Note : All dimension _ millimeters

PCB lay out _ on BeRex website

Package Marking

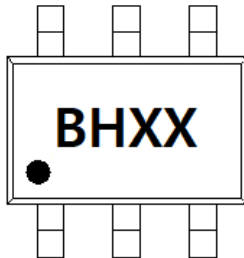

XX = Wafer No.

Pin 1

Lead plating finish

100% Tin Matte finish

(All BeRex products undergoes a 1 hour, 150 degree C, Anneal bake to eliminate thin whisker growth concerns.)

MSL / ESD Rating

ESD Rating:	Class 1B
Value:	Passes <1000V
Test:	Human Body Model (HBM)
Standard:	JEDEC Standard JS-001-2017
MSL Rating:	Level 1 at +260°C convection reflow
Standard:	JEDEC Standard J-STD-020

Tape & Reel

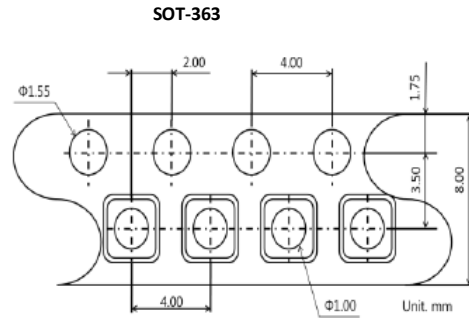

Packaging information:

- Tape Width (mm): 8
- Reel Size (inches): 7
- Device Cavity Pitch (mm): 4
- Devices Per Reel: 3000



Proper ESD procedures should be followed when handling this device.

RoHS Compliance

This part is compliant with Restrictions on the Use of Certain Hazardous Substances in Electrical and Electronic Equipment (RoHS) Directive 2011/65/EU as amended by Directive 2015/863/EU.

This product also is compliant with a concentration of the Substances of Very High Concern (SVHC) candidate list which are contained in a quantity of less than 0.1%(w/w) in each components of a product and/or its packaging placed on the European Community market by the BeRex and Suppliers.

NATO CAGE code:

2	N	9	6	F
---	---	---	---	---