

ECN/PCN No.: R0043

For Manufacturer			
Product Description: Bluetooth modules	Abracon Part Number / Part Series: ABBTM Bluetooth module series	<input type="checkbox"/> Documentation only <input type="checkbox"/> ECN <input checked="" type="checkbox"/> EOL	<input checked="" type="checkbox"/> Series <input type="checkbox"/> Part Number
Affected Revision: N/A	New Revision: EOL	Application: <input type="checkbox"/> Safety <input checked="" type="checkbox"/> Non-Safety	
Prior to Change: ABBTM-2.4GHZ, ABBTM-2.4GHZ-31, ABBTM-2.4GHZ-31-T, ABBTM-2.4GHZ-33, ABBTM-2.4GHZ-33-T, ABBTM-2.4GHZ-51, ABBTM-2.4GHZ-51-T, ABBTM-2.4GHZ-52, ABBTM-2.4GHZ-52-T, ABBTM-2.4GHZ-EVAL, ABBTM-2.4GHZ-T, ABBTM-2.4GHZ-T2, ABBTM-NVC-EVK-56, ABBTM-NVC-EVK-71, ABBTM-NVC-EVK-71-MESH, ABBTM-NVC-MB-EVK, ABBTM-NVC-MDCS42A-CON, ABBTM-NVC-MDCS71, ABBTM-NVC-MDCS71-CON, ABBTM-NVC-MDCS71-MESH, ABBTM-NVC-MDCS71-MESH-CON, ABBTM-NVC-MDCS71-101, ABBTM-NVC-MDCS86-101, ABBTM-101-2.4GHZ-T, ABBTM-2.4GHZ-51-101-, ABBTM-2.4GHZ-52-101, ABBTM-53-2.4GHZ-T, ABBTM-103-2.4GHZ-T, ABBTM-2.4GHZ-T; VER.10, ABBTM-NVC-MDCS42A-101, ABBTM-NVC-MDCS42A-F07, and ABBTM-NVC-MDCS56-102.			
After Change: All 32 EOL			
Cause/Reason for Change: Due to low demand, the Bluetooth Module ABBTM series is discontinued.			
Change Plan			
Effective Date: 06/08/2021	Additional Remarks: N/A		
Change Declaration: EOL			
Issued Date: 06/08/2021	Issued By: <i>Nicholas El-Takach</i>	Issued Department: Engineering	
Approval: <i>Syed Raza</i> Engineering VP	Approval: <i>Reuben Quintanilla</i> Quality Director	Approval: <i>Ying Huang</i> Purchasing Director	
For Abracon EOL only			
Last Time Buy (if applicable): No last time buy.	Alternate Part Number / Part Series: N/A		
Additional Approval:	Additional Approval:	Additional Approval:	
Customer Approval (If Applicable)			
Qualification Status: <input type="checkbox"/> Approved <input type="checkbox"/> Not accepted <i>Note: It is considered approved if there is no feedback from the customer 1 month after ECN/PCN is released.</i>			
Customer Part Number:		Customer Project:	
Company Name:	Company Representative:	Representative Signature:	
Customer Remarks:			

Bluetooth Module Evaluation Kit User Guide

ABBTM-NVC-EVK



RoHS
Compliant

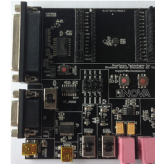

91cm x 106cm

HARDWARE DESCRIPTION:

ABBTM-NVC-EVK Bluetooth module evaluation kit is designed to facilitate engineering evaluation of Abracon's ABBTM-NVC-MDCSxx Bluetooth modules. The kit includes one main board, one Bluetooth module at the customer's choice and the corresponding adaptor board.

Ordering Information:

Part Number	Description
ABBTM-NVC-EVK-42A	Kit includes 1 main board; 1 ABBTM-NVC-MDCS42A adaptor board with 1pc ABBTM-NVC-MDCS42A mounted on the adaptor board; Mini B USB cable
ABBTM-NVC-EVK-56	Kit includes 1 main board; 1 ABBTM-NVC-MDCS56 adaptor board with 1pc ABBTM-NVC-MDCS56 mounted on the adaptor board; Mini B USB cable
ABBTM-NVC-EVK-71	Kit includes 1 main board; 1 ABBTM-NVC-MDCS71 adaptor board with 1pc ABBTM-NVC-MDCS71 mounted on the adaptor board; Mini B USB cable
ABBTM-NVC-EVK-71-MESH*	Kit includes 1 main board; 1 ABBTM-NVC-MDCS71-MESH adaptor board with 1pc ABBTM-NVC-MDCS71-MESH mounted on the adaptor board; Mini B USB cable
ABBTM-NVC-MB-EVK	Evaluation kit main board
ABBTM-NVC-MDCS42A-CON	ABBTM-NVC-MDCS42A adaptor board, BT module is mounted on board
ABBTM-NVC-MDCS56-CON	ABBTM-NVC-MDCS56 adaptor board, BT module is mounted on board
ABBTM-NVC-MDCS71-CON	ABBTM-NVC-MDCS71 adaptor board, BT module is mounted on board
ABBTM-NVC-MDCS71-MESH-CON	ABBTM-NVC-MDCS71-MESH adaptor board, BT module is mounted on board

Note *: In order to evaluate the functionality of the CSRmesh Network, multiple devices need to be paired, necessitating the procurement of multiple Evaluation units.

EVALUATION KIT MAIN BOARD:

The interfaces of the evaluation kit main board (ABBTM-NVC-BM-EVK) includes: DB9 RS232, USB UART (please visit <http://www.ftdichip.com/Drivers/VCP.htm> for latest driver), 3.5mm jack audio input/output, several buttons, LEDs.

In addition, mounting places are reserved on the main board for soldering the Apple authentication coprocessor (2.0B or 2.0C). So it can also be used as a demo or test platform of Abracon's iAP over Bluetooth solutions.

The main board also contains SPK_OUT and MIC_IN jack. There's audio amplifier converting the differential audio output from the Bluetooth module to single-ended, which can be output directly to a common 3.5mm headphone. And with on board MIC bias circuits, a microphone can be inserted directly

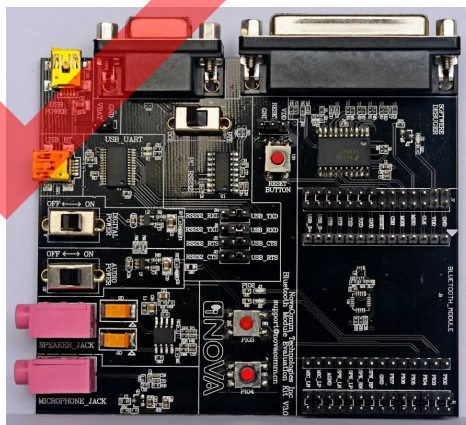

Figure 1: Evaluation Kit Main Board: ABBTM-NVC-MB-EVK

ABRACON IS
ISO 9001:2008
CERTIFIED



2 Faraday, Suite# B | Irvine | CA 92618 Revised: 03.10.15
Ph. 949.546.8000 | Fax. 949.546.8001
Visit www.abracon.com for Terms and Conditions of Sale

Bluetooth Module Evaluation Kit User Guide

ABBTM-NVC-EVK



RoHS
Compliant

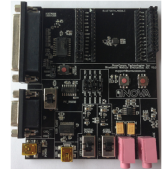

91cm x 106cm

COMPONENT DESCRIPTION:

Figure 2: Evaluation Kit Main Board Layout

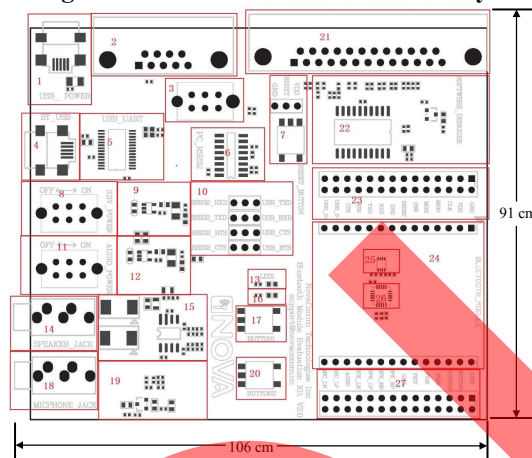

1. USB power & virtual COM: Mini B socket to power the board. And if USB to COM chip (label by 4) is mounted, it also acts as a virtual COM port (USB to COM, a driver for Windows is needed).
2. DB9 port: This can be used to connect to a RS232 COM port.
3. DCE, DTE switch: Switches the connections of the TX and RX signals to the DB9's pin 2&3.
4. USB connection to the adapter board: Mini B socket connect the USB D+/- to the adapter board sockets. With proper firmware, the Bluetooth module can act as a USB HID device, or USB CDC device (so a virtual COM port to Bluetooth SPP is achieved). And DFU (device firmware update) works on this port.
5. USB UART IC, FTDI's FT232.
6. RS232 level shift chip for the DB9 RS232 port.
7. Reset button and Jumper: Reset button to reset the Bluetooth module on adapter board. The jumper set if it's a high level or low level trigger reset. Please also connect the "RESET" jumper in connector "23".
8. Digital power switch: Switch for main 3.3v power supply. When switched to "ON" position, the corresponding LED will light.
9. Digital power circuits: Power supply to adapter board and on board digital circuits.
10. Jumper selector for COM connection: Route the UART from the adapter board to DB9 or USB UART port.
11. Audio power switch: Switch for the 3.3v power supply of the audio headphone amplifier. It is also used as the mic bias. When switched to "ON" position, the corresponding LED will light.
12. Audio power circuits. Power the on board audio amplifier and MIC Bias.
13. AUX LED 1: Connect to PIO2 of the adapter board. The function depends on firmware.
14. 3.5mm audio output jack.
15. Audio headphone amplifier. The differential audio output from the adapter board (connector labeled as 27) is amplified and output to the 3.5mm jack
16. AUX LED 2: Connect to PIO3 of the adapter board. The function depends on firmware..
17. Button1: Connect to PIO3 of the adapter board.
18. Audio input jack: mic input
19. Microphone Bias circuit: Connect a microphone in 3.5mm jack and the signals are processed and routed to MIC_LN, MIC_LP of the adapter board.
20. Button2: Connect to PIO4 of the daughter board.
21. DB25 parallel connector, for Abracon internal use only.
22. Parallel port circuits.
23. Jumpers to connect/disconnect signals to adapter board.
24. The socket of adapter board.
25. Mount place for Apple's Authentication Coprocessor: 2.0C.
26. Mount place for Apple's Authentication Coprocessor: 2.0B.
27. Jumpers to connect/disconnect signals to adapter board.

ABRACON IS
ISO 9001:2008
CERTIFIED

 **ABRACON** LLC
The Power of Linking Together

2 Faraday, Suite# B | Irvine | CA 92618 Revised: 03.10.15
Ph. 949.546.8000 | Fax. 949.546.8001
Visit www.abracon.com for Terms and Conditions of Sale

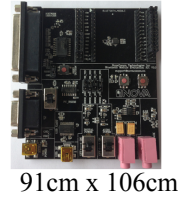

FUNCTIONAL DESCRIPTION – SWITCH AND JUMPER SETTING

Power Switch (As shown in the red line to toggle switch)

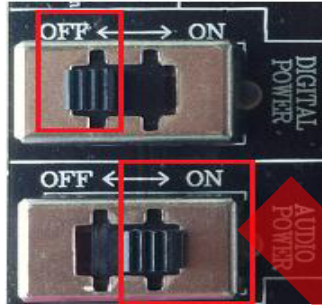

Figure 3: Power switch

DB9 or USB-COM selection (jumper connections as shown in red line connect to DB9)



Figure 4: RS232 jumper connect

DB9 or USB-COM selection (jumper connections as shown in red line connect to USB-COM)



Figure 5: USB to serial jumper connect

When use DB9, Switch to "DTE" if the EVK acts as a DTE

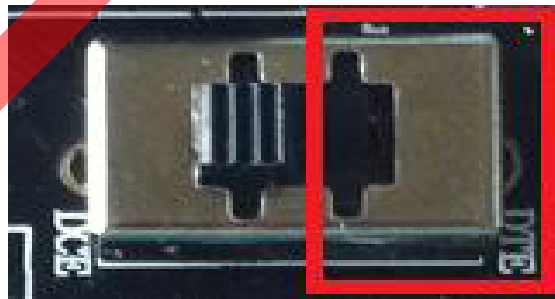

Figure 6: RS232 toggle switch (DTE)

Bluetooth Module Evaluation Kit User Guide

ABBTM-NVC-EVK



RoHS
Compliant

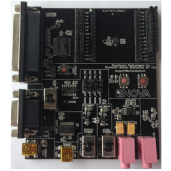

91cm x 106cm

When use DB9, Switch to "DTE" if the EVK acts as a DTE

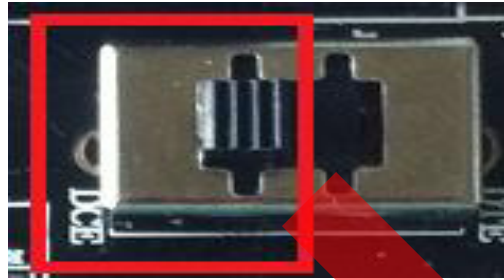

Figure 7 : RS232 toggle switch (DCE)

Jumper for feeding a high level to the daughter board's RESET when push RESET button.



Figure 8: Jumper setting for high effective RESET

Jumper for feeding a low level to the daughter board's RESET when push RESET button



Figure 9: Jumper setting for low effective RESET

Bluetooth Module Evaluation Kit User Guide

ABBTM-NVC-EVK

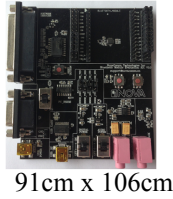

SCHEMATIC OF THE EVALUATION KIT MAIN BOARD

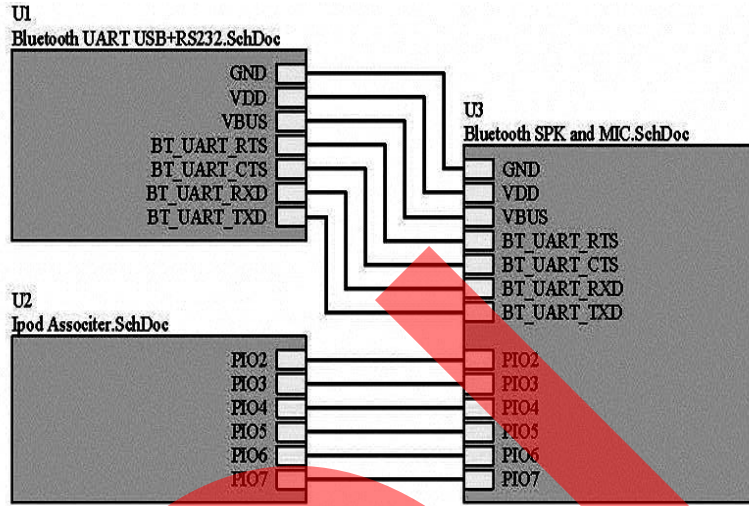

Figure 10: General schematic diagram

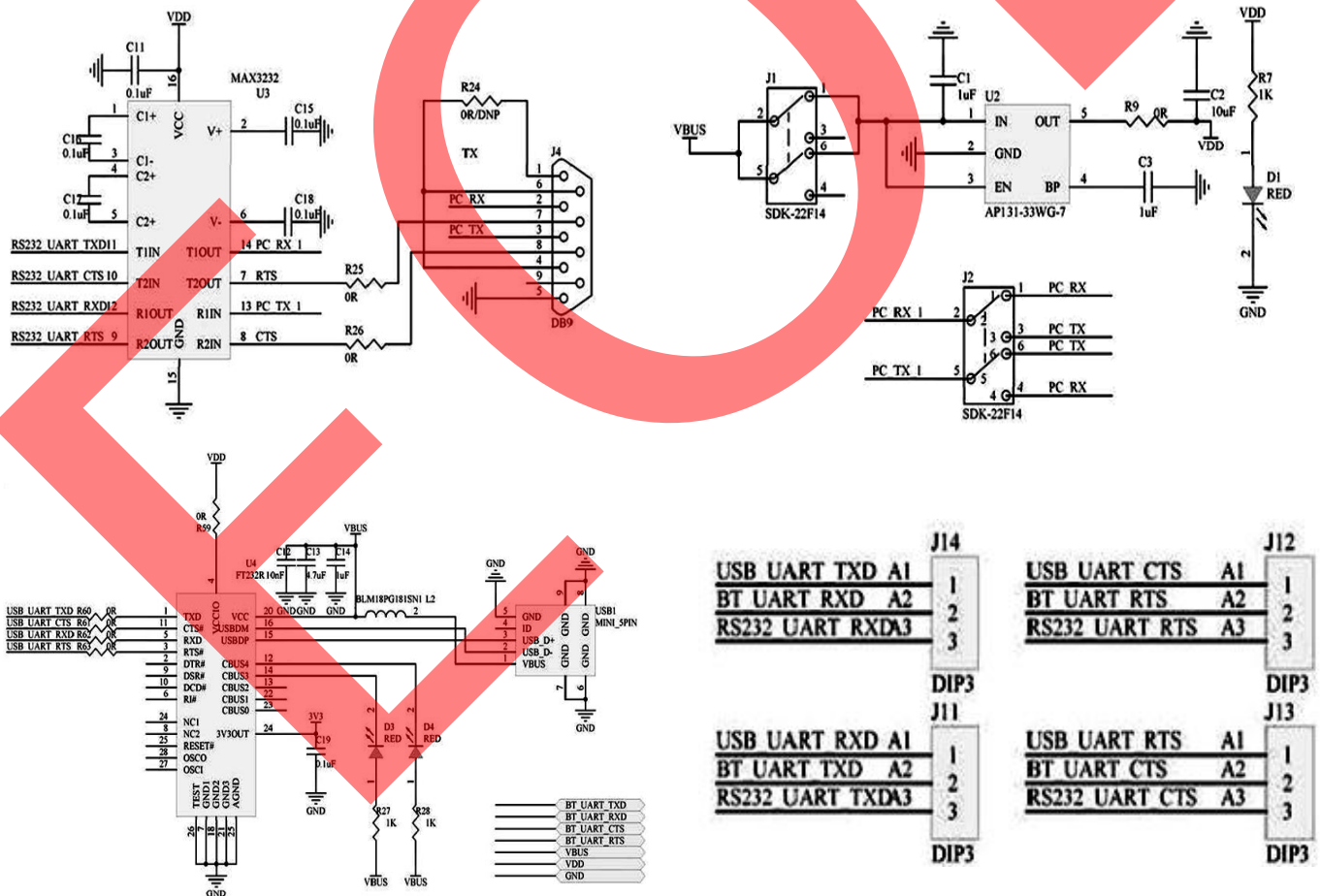

Figure 11: Module SPI and UART Schematic diagram

Bluetooth Module Evaluation Kit User Guide

ABBTM-NVC-EVK



RoHS
Compliant

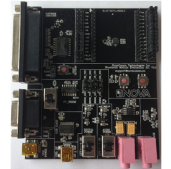

91cm x 106cm

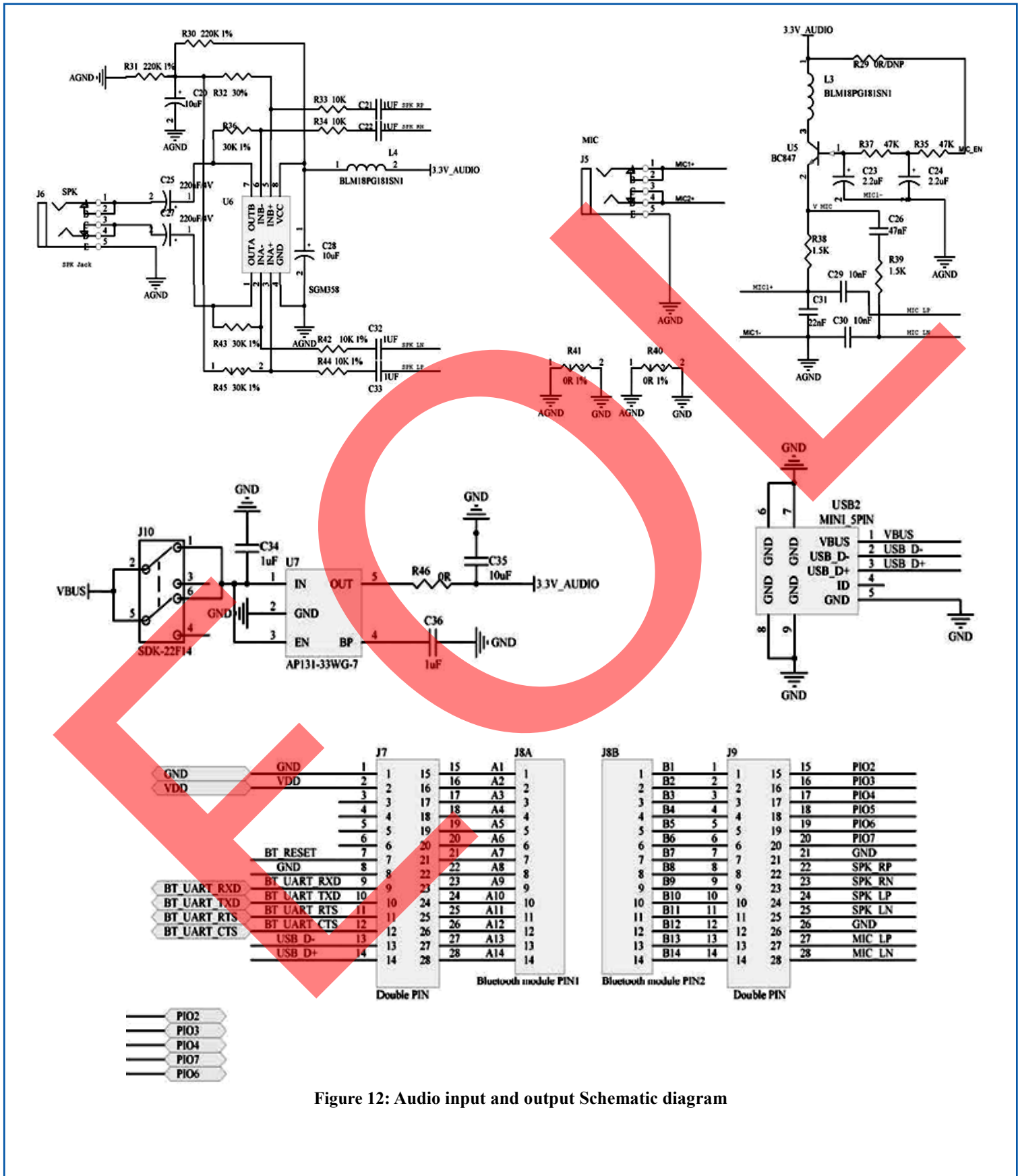

Figure 12: Audio input and output Schematic diagram

Bluetooth Module Evaluation Kit User Guide

ABBTM-NVC-EVK

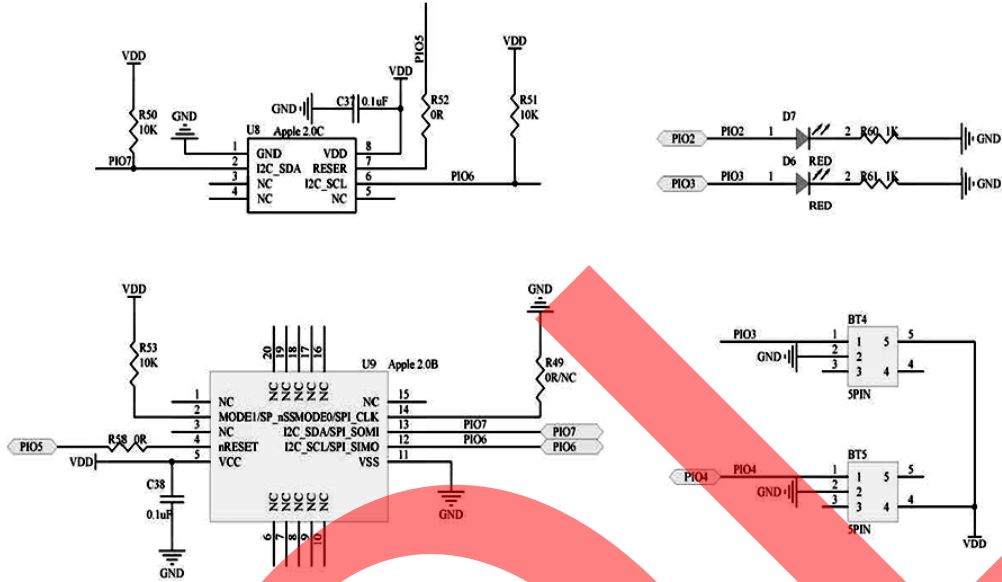
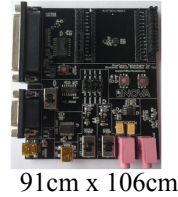

Figure 13: Apple authentication, button and LED Apple authentication

TOP SILK-SCREEN FIGURE

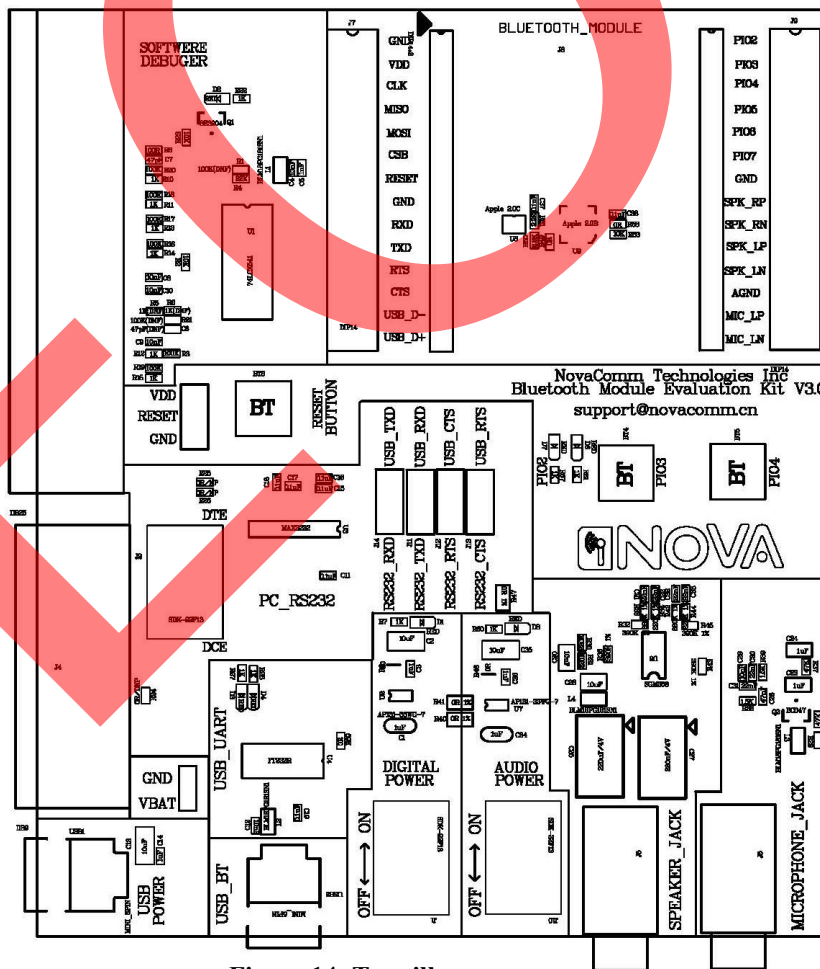

Figure 14: Top silk-screen

ABRACON IS
ISO 9001:2008
CERTIFIED



2 Faraday, Suite# B | Irvine | CA 92618 Revised: 03.10.15
Ph. 949.546.8000 | Fax. 949.546.8001
Visit www.abracon.com for Terms and Conditions of Sale

Bluetooth Module Evaluation Kit User Guide

ABBTM-NVC-EVK

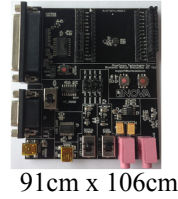

91cm x 106cm

ADAPTOR BOARDS

Different adaptor boards are used to mate with the evaluation kit main board.

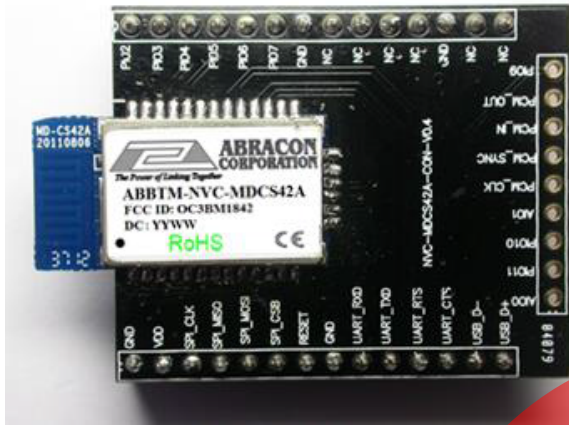

Figure 15: ABBTM-NVC-MDCS42A-CON (47.5 x 33mm)



Figure 16: ABBTM-NVC-MDCS71-CON (41 x 33mm)

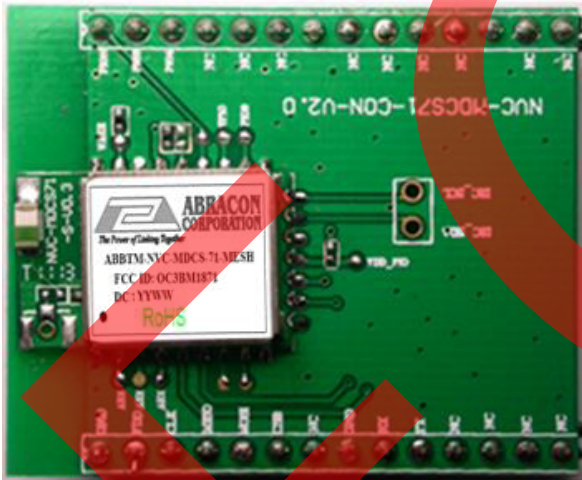

Figure 17: ABBTM-NVC-MDCS71-MESH-CON (41 x 33mm)

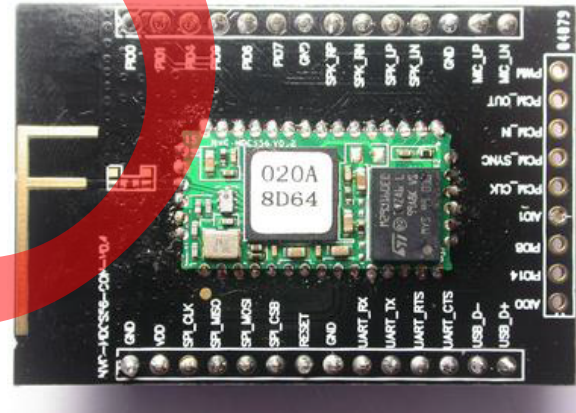

Figure 18: ABBTM-NVC-MDCS56-CON (49 x 33.5mm)

Bluetooth Module Evaluation Kit User Guide

ABBTM-NVC-EVK



RoHS
Compliant

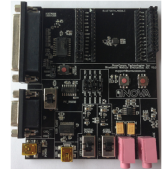

91cm x 106cm

SERIAL INTERFACE COMMUNICATION

In this demo we use a tool “AccessPort” (Freeware, can be downloaded here <http://www.sudt.com/en/ap/index.html>) to access the COM ports in Windows. Customers can use other tools (such as HypterTerminal) in a similar way.

1. Set the proper settings of the RS232 port.

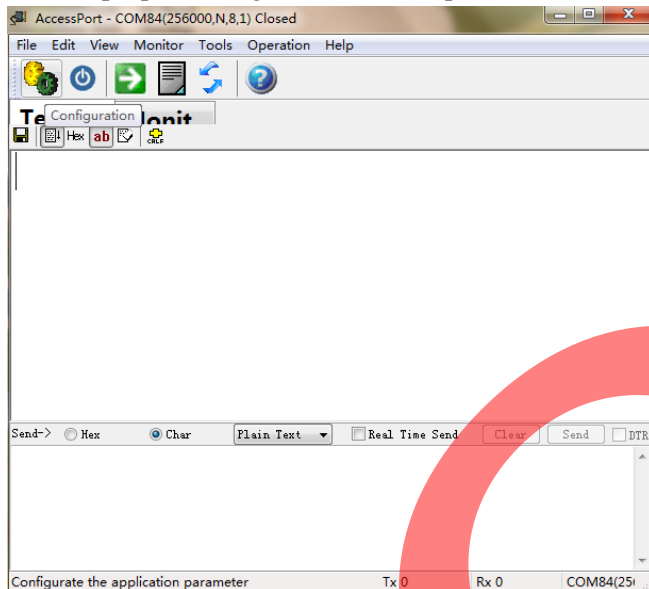

Figure 19: Access port main window

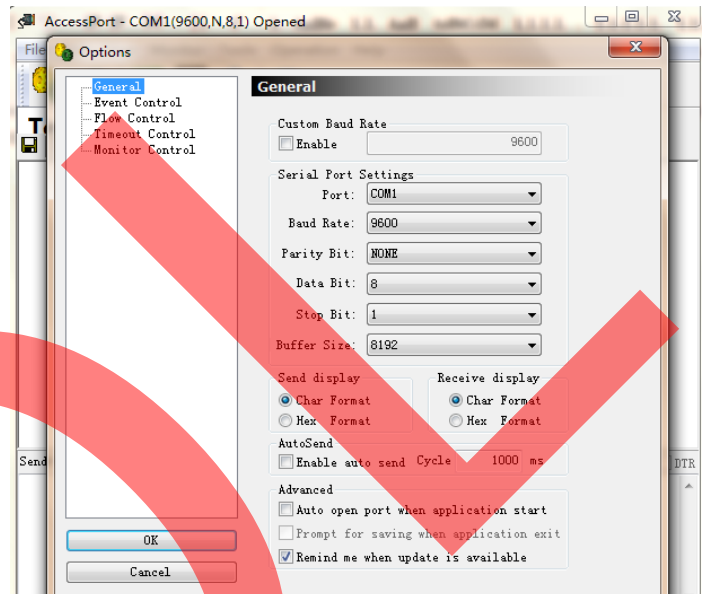

Figure 20: “COM” port settings

2. When an adapter board (a ABBTM-NVC-MDCS42-CON is used here) plugged and the power is switch on, it might show,

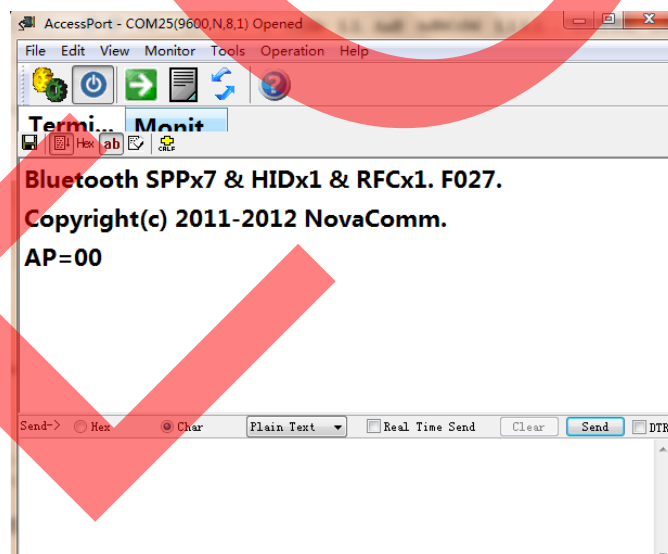

Figure 21: The Bluetooth module prints software version and status when power on

Bluetooth Module Evaluation Kit User Guide

ABBTM-NVC-EVK



RoHS
Compliant

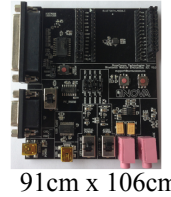

91cm x 106cm

3. Send a command to make the module discoverable. (“BC:MD=01”, refer to ACCI documents)

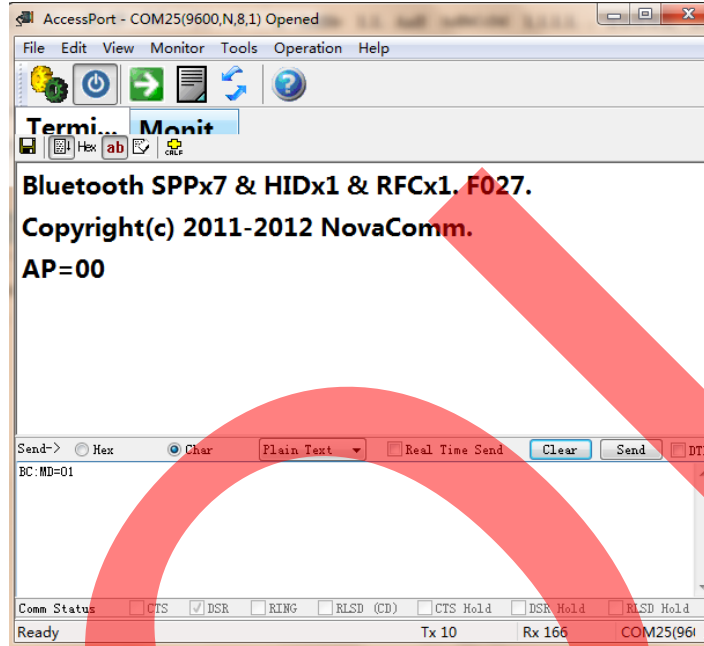

Figure 22: In send box type "BC:MD=01<RETURN>" and click "Send" button

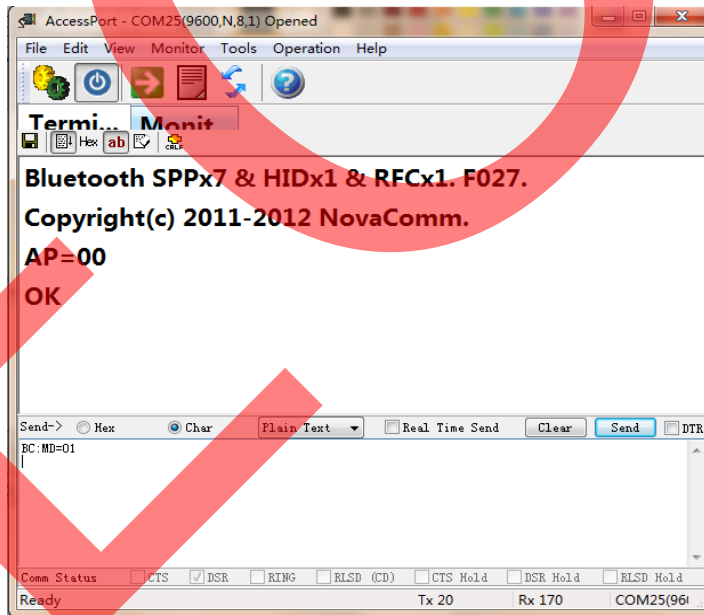

Figure 23: The Bluetooth module reports “ OK<CR><LF>” so it’s discoverable now

Note: <CR><LF> is the terminator of command line

ATTENTION: Abracon Corporation’s products are COTS – Commercial-Off-The-Shelf products; suitable for Commercial, Industrial and, where designated, Automotive Applications. Abracon’s products are not specifically designed for Military, Aviation, Aerospace, Life-dependant Medical applications or any application requiring high reliability where component failure could result in loss of life and/or property. For applications requiring high reliability and/or presenting an extreme operating environment, written consent and authorization from Abracon Corporation is required. Please contact Abracon Corporation for more information.

ABRACON IS
ISO 9001:2008
CERTIFIED



2 Faraday, Suite# B | Irvine | CA 92618 Revised: 03.10.15
Ph. 949.546.8000 | Fax. 949.546.8001
Visit www.abracon.com for Terms and Conditions of Sale