

**Customer Part:**

**Description**

- Standard 5x3.2mm SMD crystal with four pads.  
Ceramic package with a seam sealed metal lid, hermetically sealed.
- Model CFPX-104
- Model Issue number 9

**Frequency Parameters**

- Frequency 12.0MHz
- Frequency Tolerance  $\pm 20.00\text{ppm}$
- Tolerance Condition @ 25°C
- Frequency Stability  $\pm 30.00\text{ppm}$
- Operating Temperature Range -40.00 to 85.00°C
- Overtone Order Fundamental
- Ageing  $\pm 3\text{ppm}$  max per year @ 25°C

**Electrical Parameters**

- Load Capacitance (CL) 18.00pF
- Shunt Capacitance (C0) 7pF max
- Drive Level 100µW max
- ESR 90.00Ω max

**Environmental Parameters**

- Shock: 1500g, 0.5ms, 3 times in each of 3 mutually perpendicular planes
- Vibration: 20g (20Hz-2000Hz), 1.52mm amplitude, 20mins in 3 mutually perpendicular planes, 4 cycles
- Storage Temperature Range: -55 to 125°C

**Manufacturing Details**

- RoHS Terminations Au 0.3µm~1.0µm
- RoHS Reflow Temp 260degC max for 30s max

**Compliance**

- RoHS Status (2015/863/EU) Compliant
- REACH Status Compliant
- MSL Rating (JDEC-STD-033): Not Applicable

**Packaging Details**

- Pack Style: Reel Tape & reel in accordance with EIA-481-D  
Pack Size: 1,000
- *Alternative packing option available*



**Outline (mm)**

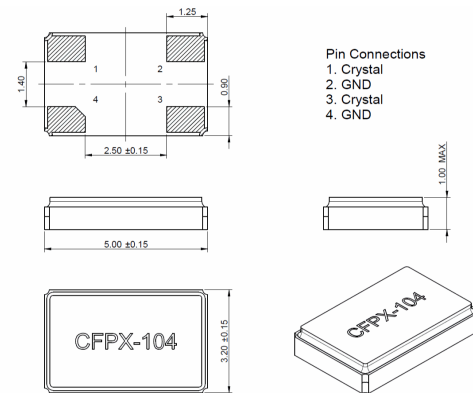

NOTE: The chamfer may appear on pad 1 or 4.  
This causes no change to the electrical performance of the device.

**Recommended Solder Pad Layout**



**Sales Office Contact Details:**

UK: +44 (0)1460 270200  
Germany: 0800 1808 443

France: 0800 901 383  
USA: +1.760.318.2824

Email: [info@iqdfrequencyproducts.com](mailto:info@iqdfrequencyproducts.com)  
Web: [www.iqdfrequencyproducts.com](http://www.iqdfrequencyproducts.com)