

MOLEX P/N	LENGTH	TOLERANCE	RAW CABLE IMPEDANCE	AWG	MECHANICAL SPECIFICATION	ELECTRICAL SPECIFICATION
2050581000	300mm	±10mm	85 Ohms	34	SFF-8611	PCI EXPRESS OCuLink SPECIFICATION REV 1.0
2050581001	500mm	±10mm	85 Ohms	34	SFF-8611	PCI EXPRESS OCuLink SPECIFICATION REV 1.0
2050581002	1000mm	±15mm	85 Ohms	34	SFF-8611	PCI EXPRESS OCuLink SPECIFICATION REV 1.0
2050581003	200mm	±10mm	85 Ohms	34	SFF-8611	PCI EXPRESS OCuLink SPECIFICATION REV 1.0 EXCEPT RETURN LOSS AND FITTED IL
2050581004	600mm	±10mm	85 Ohms	34	SFF-8611	PCI EXPRESS OCuLink SPECIFICATION REV 1.0
2050581005	650mm	±10mm	85 Ohms	34	SFF-8611	PCI EXPRESS OCuLink SPECIFICATION REV 1.0
2050581007	350mm	±10mm	85 Ohms	34	SFF-8611	PCI EXPRESS OCuLink SPECIFICATION REV 1.0
2050581010	150mm	±10mm	85 Ohms	34	SFF-8611	PCI EXPRESS OCuLink SPECIFICATION REV 1.0 EXCEPT RETURN LOSS AND FITTED IL

NOTES:

- MATERIALS:**
 - BACKSHELLS - GLASS FILLED LCP, UL94-V0
COLOR: BLACK
 - LATCHING - STAINLESS STEEL
 - CABLE - TWIN-AX SHIELD: ALUMINIZED POLYESTER FOIL
- SIGNAL PAIR: SOLID SILVER PLATED COPPER
- DRAIN: SOLID COATED COPPER
- CONFORMS TO VW1
 - PCB - HALOGEN FREE
- PLUG MATES TO RIGHT-ANGLE AND VERTICAL RECEPTACLE SERIES 173162.
- RoHS COMPLIANT. NO EXCEPTIONS.
- MINIMAL GAP FROM TAPE TO BACKSHELL IS ACCEPTABLE.

SYMBOLS	THIS DRAWING CONTAINS INFORMATION THAT IS PROPRIETARY TO MOLEX ELECTRONIC TECHNOLOGIES, LLC AND SHOULD NOT BE USED WITHOUT WRITTEN PERMISSION		CURRENT REV DESC:	
	DIMENSION UNITS	SCALE		
▽ = 0	mm	NTS		
▽ = 0	GENERAL TOLERANCES (UNLESS SPECIFIED)			
▽ = 0	ANGULAR TOL	±		
▽ = 0	4 PLACES	±		
▽ = 0	3 PLACES	±		
▽ = 0	2 PLACES	±		
▽ = 0	1 PLACE	±		
▽ = 0	0 PLACES	±		
■ = 0	DRAFT WHERE APPLICABLE MUST REMAIN WITHIN DIMENSIONS		THIRD ANGLE PROJECTION	
▽ = 0			DRAWING	SERIES
		D-SIZE		205058
DOCUMENT STATUS		P1	RELEASE DATE	2019/08/02 07:22:37
		EC NO: 621788		
		DRWN: SMALLESHAPPA		2019/08/01
		CHK'D: PHSU01		2019/08/02
		APPR: VPENG01		2019/08/02
		INITIAL REVISION:		
		DRWN: LOU01		2017/08/07
		APPR: RHSU01		2017/08/23
DOCUMENT NUMBER		DOC TYPE	DOC PART	REVISION
2050581000		PSD	000	E
MATERIAL NUMBER		CUSTOMER		SHEET NUMBER
SEE P/N TABLE		GENERAL MARKET		1 OF 4

molex

8X STR NP10 TO 8X STR NP10 2PC LATCH

PRODUCT CUSTOMER DRAWING

DOCUMENT NUMBER DOC TYPE DOC PART REVISION

2050581000 PSD 000 E

MATERIAL NUMBER CUSTOMER SHEET NUMBER

SEE P/N TABLE GENERAL MARKET 1 OF 4

PINOUT TABLE

P1				P2	
PIN #	DESCRIPTION	SIGNAL TYPE	WIRE ID	PIN #	DESCRIPTION
A1	GROUND	----	TWINAX1	B1	GROUND
A2	PERp0	<---	TWINAX1	B2	PETp0
A3	PERn0	<---	TWINAX1	B3	PETn0
A4	GROUND	----	TWINAX2	B4	GROUND
A5	PERp1	<---	TWINAX2	B5	PETp1
A6	PERn1	<---	TWINAX2	B6	PETn1
A7	GROUND	----	TWINAX3	B7	GROUND
A8	BP_TYPEA	<---	TWINAX3	B8	BP_TYPEA
A9	CWAKEA#	<---	TWINAX3	B9	CWAKEA#
A10	RESERVED	NC	NO WIRE	B10	RESERVED
A11	VSPA+	<---	TWINAX4	B11	VSPA+
A12	VSPA-	<---	TWINAX4	B12	VSPA-
A13	GROUND	----	TWINAX4	B13	GROUND
A14	PERp2	<---	TWINAX5	B14	PETp2
A15	PERn2	<---	TWINAX5	B15	PETn2
A16	GROUND	----	TWINAX5	B16	GROUND
A17	PERp3	<---	TWINAX6	B17	PETp3
A18	PERn3	<---	TWINAX6	B18	PETn3
A19	GROUND	----	TWINAX6	B19	GROUND
A20	RESERVED	NC	NO WIRE	B20	RESERVED
A21	RESERVED	NC	NO WIRE	B21	RESERVED
A22	GROUND	----	TWINAX7	B22	GROUND
A23	PERp4	<---	TWINAX7	B23	PETp4
A24	PERn4	<---	TWINAX7	B24	PETn4
A25	GROUND	----	TWINAX8	B25	GROUND
A26	PERp5	<---	TWINAX8	B26	PETp5
A27	PERn5	<---	TWINAX8	B27	PETn5
A28	GROUND	----	TWINAX9	B28	GROUND
A29	BP_TYPEB	<---	TWINAX9	B29	BP_TYPEB
A30	CWAKEB#	<---	TWINAX9	B30	CWAKEB#
A31	RESERVED	NC	NO WIRE	B31	RESERVED
A32	VSPB+	<---	TWINAX10	B32	VSPB+
A33	VSPB-	<---	TWINAX10	B33	VSPB-
A34	GROUND	----	TWINAX10	B34	GROUND
A35	PERp6	<---	TWINAX11	B35	PETp6
A36	PERn6	<---	TWINAX11	B36	PETn6
A37	GROUND	----	TWINAX11	B37	GROUND
A38	PERp7	<---	TWINAX12	B38	PETp7
A39	PERn7	<---	TWINAX12	B39	PETn7
A40	GROUND	----	TWINAX12	B40	GROUND

P1				P2	
PIN #	DESCRIPTION	SIGNAL TYPE	WIRE ID	PIN #	DESCRIPTION
B1	GROUND	----	TWINAX13	A1	GROUND
B2	PETp0	--->	TWINAX13	A2	PERp0
B3	PETn0	--->	TWINAX13	A3	PERn0
B4	GROUND	----	TWINAX14	A4	GROUND
B5	PETp1	--->	TWINAX14	A5	PERp1
B6	PETn1	--->	TWINAX14	A6	PERn1
B7	GROUND	----	TWINAX15	A7	GROUND
B8	2-WIRE CLOCKA	--->	TWINAX15	A8	2-WIRE CLOCKA
B9	2-WIRE DATAA	--->	TWINAX15	A9	2-WIRE DATAA
B10	RESERVED	NC	NO WIRE	A10	RESERVED
B11	PERSTA#	--->	TWINAX16	A11	PERSTA#
B12	CPRSNTA#	--->	TWINAX16	A12	CPRSNTA#
B13	GROUND	----	TWINAX16	A13	GROUND
B14	PETp2	--->	TWINAX17	A14	PERp2
B15	PETn2	--->	TWINAX17	A15	PERn2
B16	GROUND	----	TWINAX17	A16	GROUND
B17	PETp3	--->	TWINAX18	A17	PERp3
B18	PETn3	--->	TWINAX18	A18	PERn3
B19	GROUND	----	TWINAX18	A19	GROUND
B20	RESERVED	NC	NO WIRE	A20	RESERVED
B21	RESERVED	NC	NO WIRE	A21	RESERVED
B22	GROUND	----	TWINAX19	A22	GROUND
B23	PETp4	--->	TWINAX19	A23	PERp4
B24	PETn4	--->	TWINAX19	A24	PERn4
B25	GROUND	----	TWINAX20	A25	GROUND
B26	PETp5	--->	TWINAX20	A26	PERp5
B27	PETn5	--->	TWINAX20	A27	PERn5
B28	GROUND	----	TWINAX21	A28	GROUND
B29	2-WIRE CLOCKB	--->	TWINAX21	A29	2-WIRE CLOCKB
B30	2-WIRE DATAB	--->	TWINAX21	A30	2-WIRE DATAB
B31	RESERVED	NC	NO WIRE	A31	RESERVED
B32	PERSTB#	--->	TWINAX22	A32	PERSTB#
B33	CPRSNTB#	--->	TWINAX22	A33	CPRSNTB#
B34	GROUND	----	TWINAX22	A34	GROUND
B35	PETp6	--->	TWINAX23	A35	PERp6
B36	PETn6	--->	TWINAX23	A36	PERn6
B37	GROUND	----	TWINAX23	A37	GROUND
B38	PETp7	--->	TWINAX24	A38	PERp7
B39	PETn7	--->	TWINAX24	A39	PERn7
B40	GROUND	----	TWINAX24	A40	GROUND

LEGEND

- = THRU LINE
- > = TRANSMIT TO RECEIVE ON HIGH SPEED LINE
- <--> = SIDEBAND
- NC = NOT CONNECTED

P1 & P2

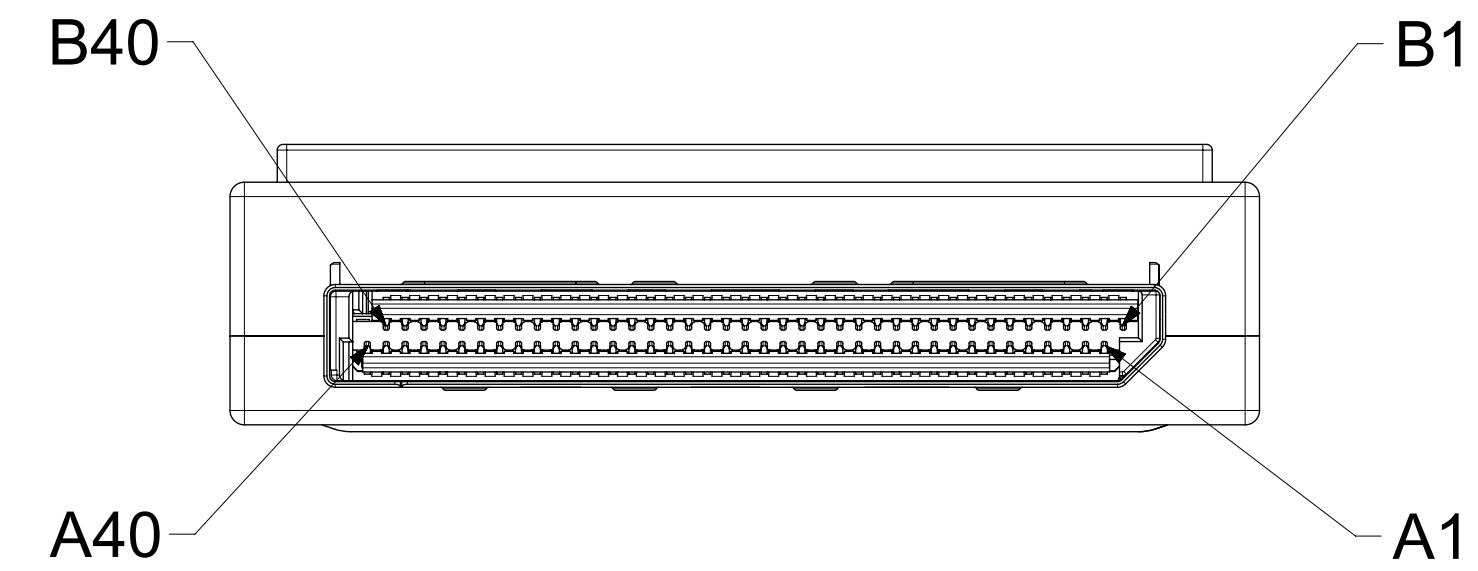

SYMBOLS	THIS DRAWING CONTAINS INFORMATION THAT IS PROPRIETARY TO MOLEX ELECTRONIC TECHNOLOGIES, LLC AND SHOULD NOT BE USED WITHOUT WRITTEN PERMISSION		CURRENT REV DESC:		<h1>molex</h1>
	DIMENSION UNITS	SCALE			
▽ = 0	mm	NTS			8X STR NPPIO TO 8X STR NPPIO 2PC LATCH
▽ = 0	GENERAL TOLERANCES (UNLESS SPECIFIED)				
▽ = 0	ANGULAR TOL	±			PRODUCT CUSTOMER DRAWING
▽ = 0	4 PLACES	±			
▽ = 0	3 PLACES	±			DOCUMENT NUMBER
▽ = 0	2 PLACES	±			
▽ = 0	1 PLACE	±			2050581000
▽ = 0	0 PLACES	±			
☒ = 0	DRAFT WHERE APPLICABLE MUST REMAIN WITHIN DIMENSIONS	THIRD ANGLE PROJECTION	DRAWING	SERIES	MATERIAL NUMBER
▽ = 0			D-SIZE	205058	
			MATERIAL NUMBER		CUSTOMER
			SEE P/N TABLE		
			GENERAL MARKET		SHEET NUMBER
			2 OF 4		

LABEL DETAIL

MOLEX P/N ---->
 MANUFACTURING LOCATION ---->
 MANUFACTURE DATE ---->
 WW: WEEK OF YEAR
 YY: LAST TWO DIGITS OF YEAR

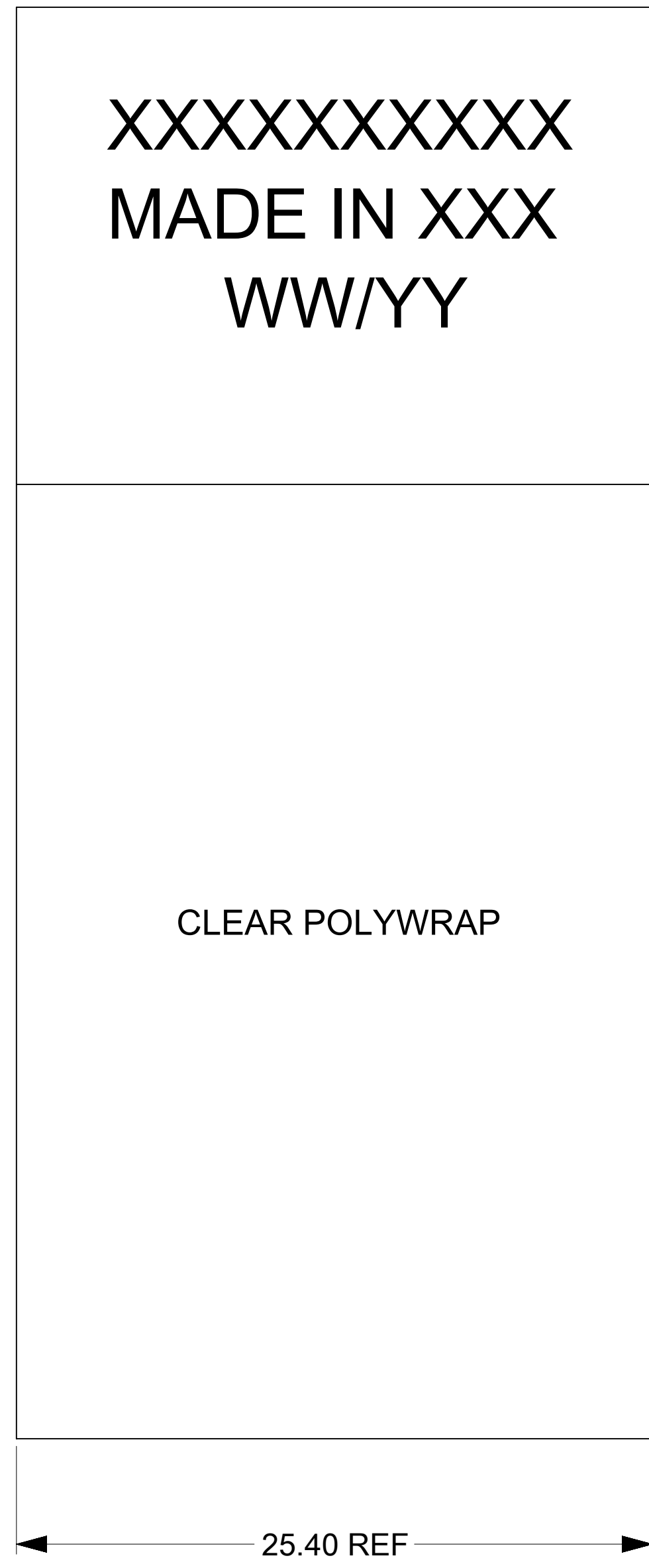

SYMBOLS ▽ = 0 ▽ = 0 ▽ = 0 ▽ = 0 ▽ = 0 ▽ = 0 ▽ = 0 ▽ = 0 ▽ = 0 ▽ = 0 ▽ = 0	THIS DRAWING CONTAINS INFORMATION THAT IS PROPRIETARY TO MOLEX ELECTRONIC TECHNOLOGIES, LLC AND SHOULD NOT BE USED WITHOUT WRITTEN PERMISSION		
	DIMENSION UNITS	SCALE	CURRENT REV DESC:
	mm	NTS	
	GENERAL TOLERANCES (UNLESS SPECIFIED)		
	ANGULAR TOL	±	°
	4 PLACES	±	
	3 PLACES	±	
	2 PLACES	±	
	1 PLACE	±	
	0 PLACES	±	
DRAFT WHERE APPLICABLE MUST REMAIN WITHIN DIMENSIONS	THIRD ANGLE PROJECTION	DRAWING	SERIES
		D-SIZE	205058
DOCUMENT NUMBER		DOC TYPE	DOC PART
2050581000		PSD	000
MATERIAL NUMBER		CUSTOMER	SHEET NUMBER
SEE P/N TABLE		GENERAL MARKET	3 OF 4

molex

8X STR NP10 TO 8X STR NP10 2PC LATCH







PRODUCT CUSTOMER DRAWING

EC NO: 621788
 DRWN: SMALLESHAPPA 2019/08/01
 CHK'D: PHSU01 2019/08/02
 APPR: VPENG01 2019/08/02

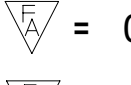
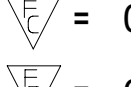
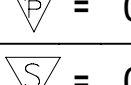
INITIAL REVISION:
 DRWN: LOU01 2017/08/07
 APPR: RHSU01 2017/08/23

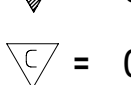
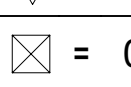
REVISION HISTORY

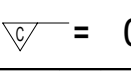
DATE	REV	DESCRIPTION	ENGINEER
2019/08/01	E	SHEET 01: ADDED ONE MORE P/N 2050581010 TO THE P/N TABLE	SACHIN M K

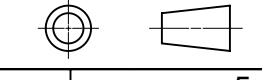
SYMBOLS  = 0  = 0  = 0  = 0  = 0  = 0  = 0  = 0	THIS DRAWING CONTAINS INFORMATION THAT IS PROPRIETARY TO MOLEX ELECTRONIC TECHNOLOGIES, LLC AND SHOULD NOT BE USED WITHOUT WRITTEN PERMISSION		DIMENSION UNITS: mm SCALE: NTS		CURRENT REV DESC:					
	GENERAL TOLERANCES (UNLESS SPECIFIED)		EC NO: 621788		DRWN: SMALLESHAPPA 2019/08/01					
	ANGULAR TOL ± °		4 PLACES ±		CHK'D: PHSU01 2019/08/02		PRODUCT CUSTOMER DRAWING			
	3 PLACES ±		3 PLACES ±		APPR: VPENG01 2019/08/02		DOCUMENT NUMBER: 2050581000 DOC TYPE: PSD DOC PART: 000 REVISION: E			
	2 PLACES ±		2 PLACES ±		INITIAL REVISION:		MATERIAL NUMBER: 205058 CUSTOMER: GENERAL MARKET SHEET NUMBER: 4 OF 4			
	1 PLACE ±		1 PLACE ±		DRWN: LOU01 2017/08/07		DRAFT WHERE APPLICABLE MUST REMAIN WITHIN DIMENSIONS			
	0 PLACES ±		0 PLACES ±		APPR: RHSU01 2017/08/23		THIRD ANGLE PROJECTION			
	DRAFT WHERE APPLICABLE MUST REMAIN WITHIN DIMENSIONS		DRAWING: D-SIZE		SERIES: 205058		SHEET NUMBER: 4 OF 4			
	DRAFT WHERE APPLICABLE MUST REMAIN WITHIN DIMENSIONS		DRAWING: 		SERIES: 205058		SHEET NUMBER: 4 OF 4			