

RECOMMENDED PCB(CONNECTOR SIDE VIEW)
THICKNESS=1.6 TO 2.4 MM

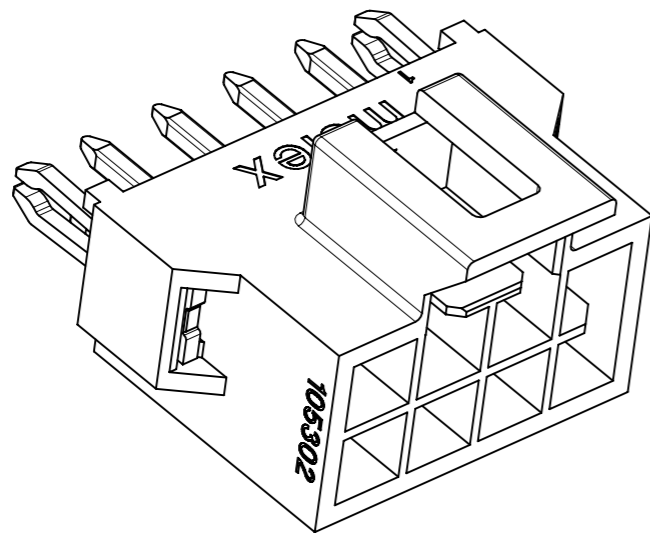

THIS DRAWING CONTAINS INFORMATION THAT IS PROPRIETARY TO MOLEX ELECTRONIC TECHNOLOGIES, LLC AND SHOULD NOT BE USED WITHOUT WRITTEN PERMISSION												
QUALITY SYMBOLS 	2020/08/26	GENERAL TOLERANCES (UNLESS SPECIFIED)		DIMENSION UNITS	SCALE							
	2020/08/27	ANGULAR TOL ± 3.0 °		mm	5:1							
	2020/08/27	4 PLACES	±	DRWN BY	DATE	HEADER OF NANO-FIT, D/R, CLIP, VERTICAL POWER CONNECTOR						
		3 PLACES	± 0.1	GLLI	2014/07/16							
		2 PLACES	± 0.2	CHK'D BY	DATE	PRODUCT CUSTOMER DRAWING						
		1 PLACE	± 0.3	APPR BY	DATE							
		0 PLACES	±	AYIN	2015/04/08	SERIES	MATERIAL NUMBER	CUSTOMER				
				DRAFT WHERE APPLICABLE MUST REMAIN WITHIN DIMENSIONS	DRAWING SIZE	THIRD ANGLE PROJECTION	105312	SEE SHEET 3	GENERAL MARKET			
					A3		DOCUMENT NUMBER		DOC TYPE	DOC PART	SHEET NUMBER	
							1053122100-SD	PSD	000	1 OF 5		

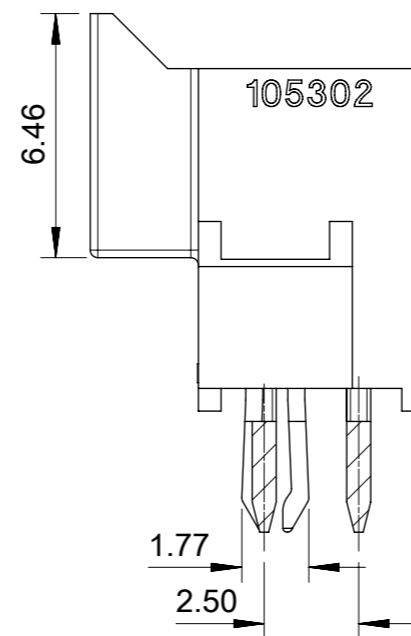
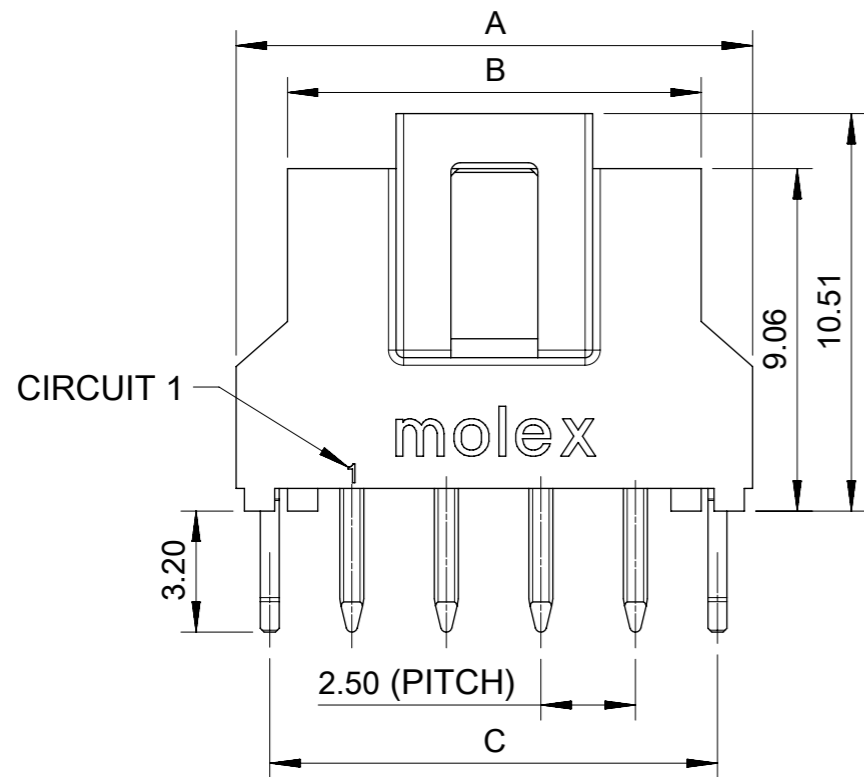
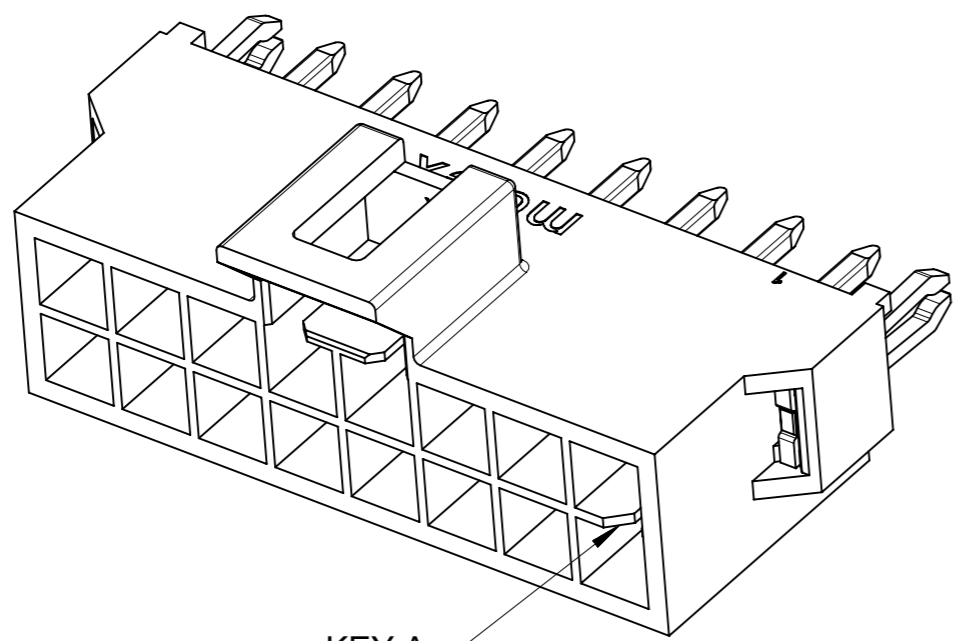

KEY A

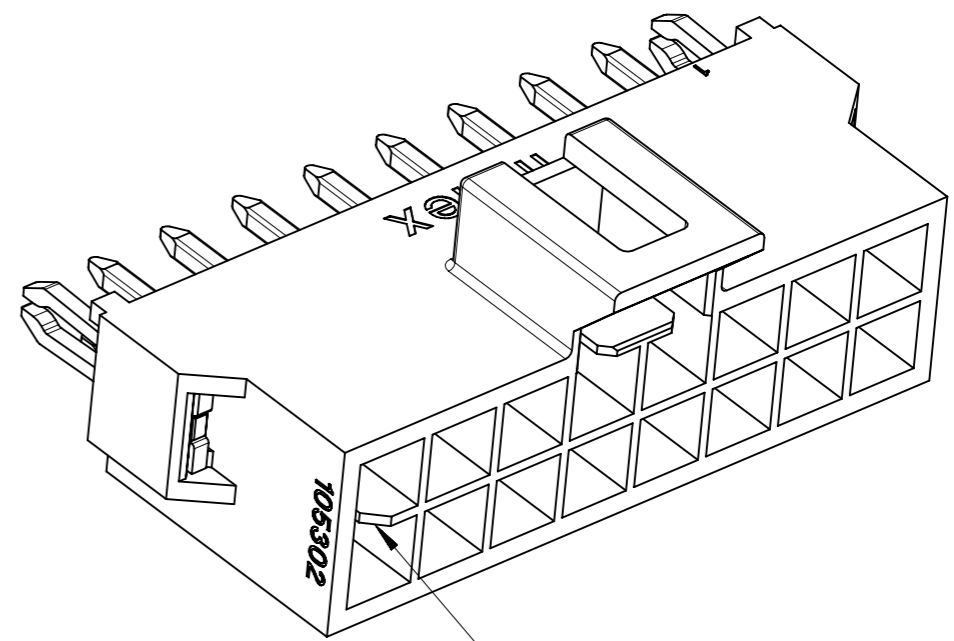

KEY B

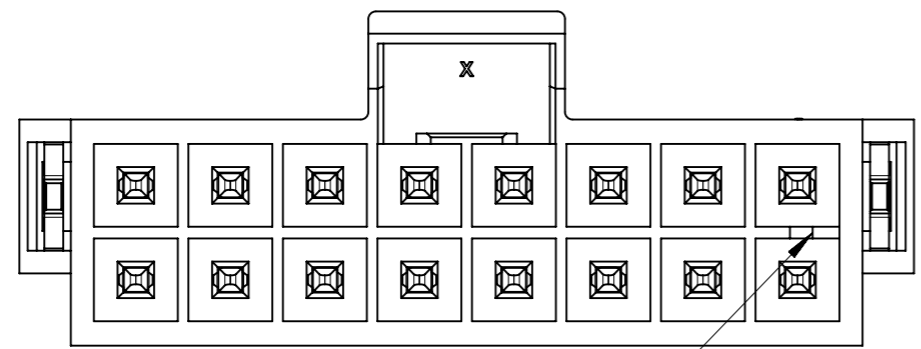

KEY A

BLACK

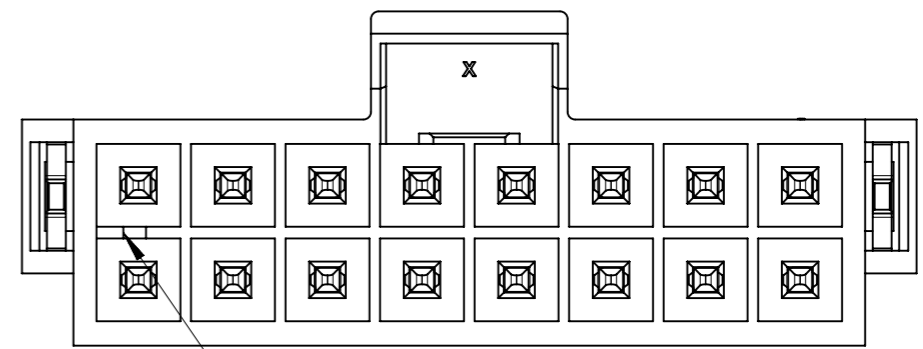

KEY B

NATURAL

COLOR OPTION

THIS DRAWING CONTAINS INFORMATION THAT IS PROPRIETARY TO MOLEX ELECTRONIC TECHNOLOGIES, LLC AND SHOULD NOT BE USED WITHOUT WRITTEN PERMISSION									
SYMBOLS	DIMENSION UNITS	SCALE	CURRENT REV DESC:				molex		
	mm								
▽ = 0	GENERAL TOLERANCES (UNLESS SPECIFIED)		EC NO: 644052				HEADER OF NANO-FIT, D/R, CLIP, VERTICAL POWER CONNECTOR		
▽ = 0	ANGULAR TOL ± 3.0°		DRWN: GLLI 2020/08/26				PRODUCT CUSTOMER DRAWING		
▽ = 0	4 PLACES ±		CHK'D: YXZHENG 2020/08/27				DOCUMENT NUMBER		
▽ = 0	3 PLACES ± 0.1		APPR: YXZHENG 2020/08/27				DOC TYPE		
▽ = 0	2 PLACES ± 0.2		INITIAL REVISION:				DOC PART		
▽ = 0	1 PLACE ± 0.3		DRWN: GLLI 2020/02/21				REVISION		
▽ = 0	0 PLACES ±		APPR: YXZHENG 2020/08/27				1053122100-SD		
□ = 0	DRAFT WHERE APPLICABLE MUST REMAIN WITHIN DIMENSIONS		THIRD ANGLE PROJECTION	DRAWING	SERIES	MATERIAL NUMBER	CUSTOMER	SHEET NUMBER	
▽ = 0				A3-SIZE	105312	SEE SHEET 3	GENERAL MARKET	2 OF 5	



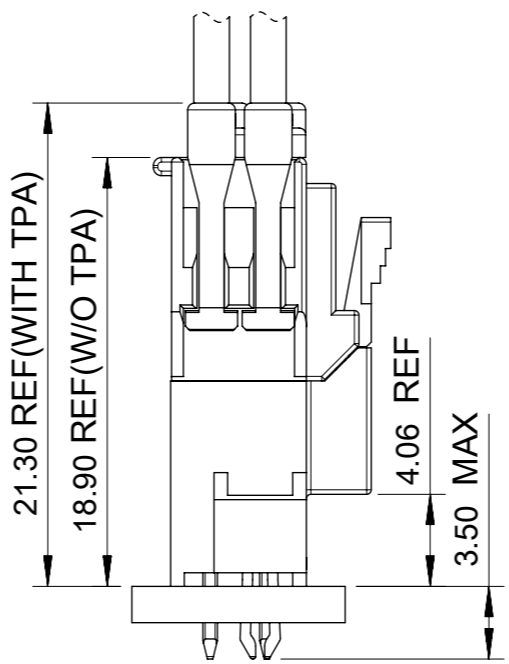



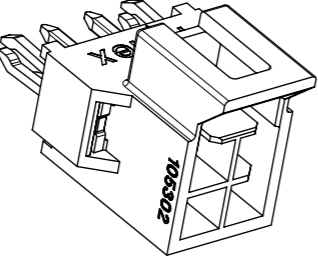
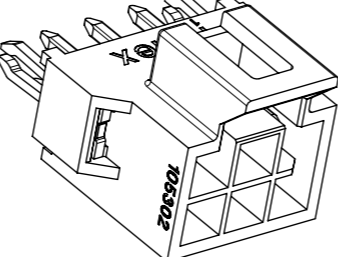
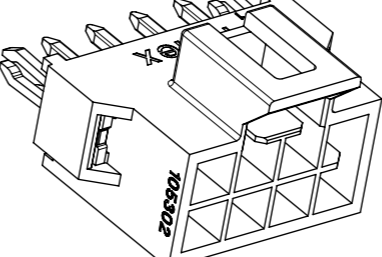
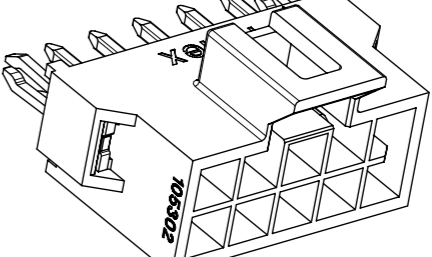
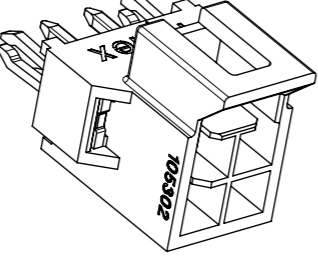
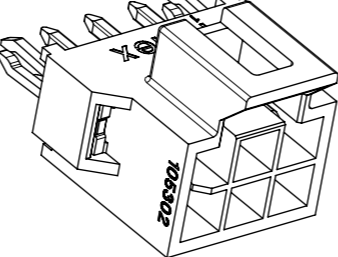
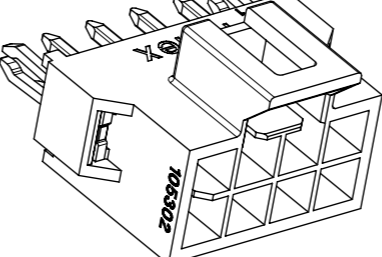
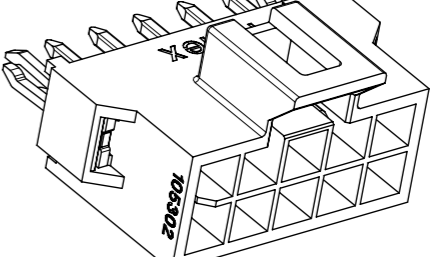
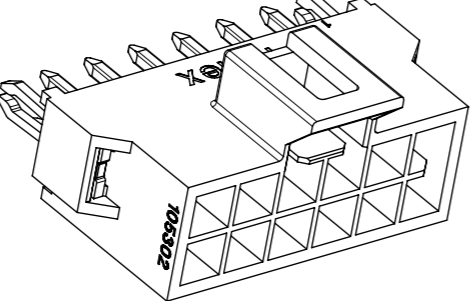
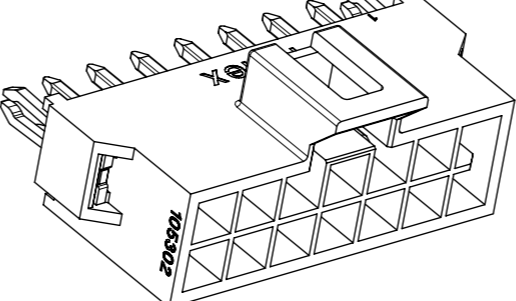
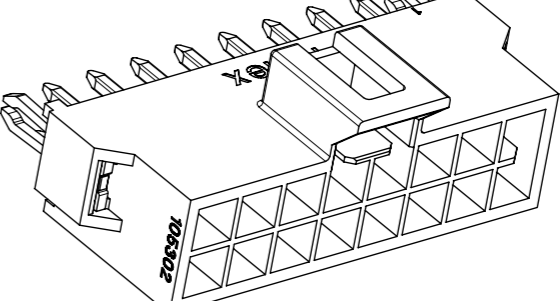
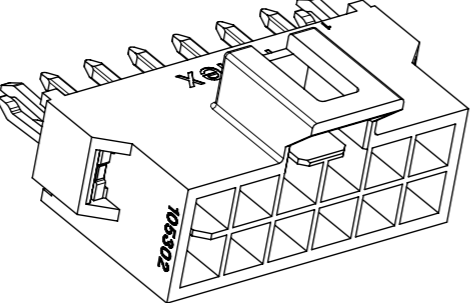
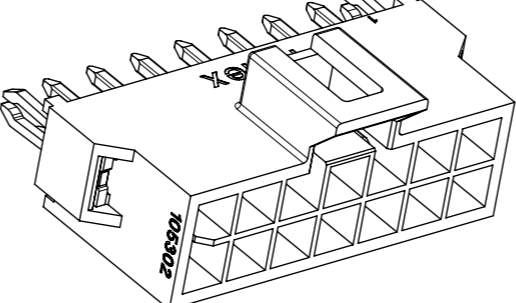
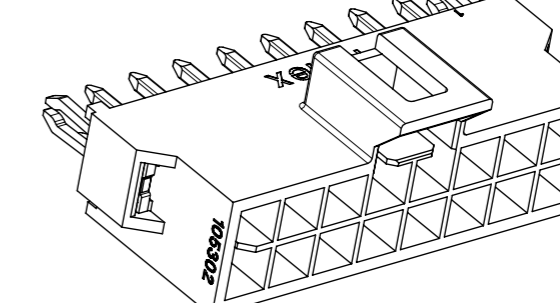

9		8		7		6		5		4		3		2		1	
PART NUMBER	DIM 'A'	DIM 'B'	DIM 'C'	CKT SIZE	PLATING												
105312-5104	8.66	5.94	6.84	4	TIN												
105312-5106	11.16	8.44	9.34	6													
105312-5108	13.66	10.94	11.84	8													
105312-5110	16.16	13.44	14.34	10													
105312-5112	18.66	15.94	16.84	12													
105312-5114	21.16	18.44	19.34	14													
105312-5116	23.66	20.94	21.84	16													
105312-5204	8.66	5.94	6.84	4		GOLD 0.38											
105312-5206	11.16	8.44	9.34	6													
105312-5208	13.66	10.94	11.84	8													
105312-5210	16.16	13.44	14.34	10													
105312-5212	18.66	15.94	16.84	12													
105312-5214	21.16	18.44	19.34	14													
105312-5216	23.66	20.94	21.84	16													
105312-5304	8.66	5.94	6.84	4	GOLD 0.76												
105312-5306	11.16	8.44	9.34	6													
105312-5308	13.66	10.94	11.84	8													
105312-5310	16.16	13.44	14.34	10													
105312-5312	18.66	15.94	16.84	12													
105312-5314	21.16	18.44	19.34	14													
105312-5316	23.66	20.94	21.84	16													
COLOR: BLACK																	



9		8		7		6		5		4		3		2		1	
PART NUMBER	DIM 'A'	DIM 'B'	DIM 'C'	CKT SIZE	PLATING												
105312-6104	8.66	5.94	6.84	4	TIN												
105312-6106	11.16	8.44	9.34	6													
105312-6108	13.66	10.94	11.84	8													
105312-6110	16.16	13.44	14.34	10													
105312-6112	18.66	15.94	16.84	12													
105312-6114	21.16	18.44	19.34	14													
105312-6116	23.66	20.94	21.84	16													
105312-6204	8.66	5.94	6.84	4		GOLD 0.38											
105312-6206	11.16	8.44	9.34	6													
105312-6208	13.66	10.94	11.84	8													
105312-6210	16.16	13.44	14.34	10													
105312-6212	18.66	15.94	16.84	12													
105312-6214	21.16	18.44	19.34	14													
105312-6216	23.66	20.94	21.84	16													
105312-6304	8.66	5.94	6.84	4	GOLD 0.76												
105312-6306	11.16	8.44	9.34	6													
105312-6308	13.66	10.94	11.84	8													
105312-6310	16.16	13.44	14.34	10													
105312-6312	18.66	15.94	16.84	12													
105312-6314	21.16	18.44	19.34	14													
105312-6316	23.66	20.94	21.84	16													
COLOR: NATURAL																	

SYMBOLS = 0 = 0 = 0 = 0 = 0 = 0 = 0 = 0 = 0	THIS DRAWING CONTAINS INFORMATION THAT IS PROPRIETARY TO MOLEX ELECTRONIC TECHNOLOGIES, LLC AND SHOULD NOT BE USED WITHOUT WRITTEN PERMISSION DIMENSION UNITS: mm SCALE:	CURRENT REV DESC: EC NO: 644052 DRWN: GLLI 2020/08/26 CHK'D: YXZHENG 2020/08/27 APPR: YXZHENG 2020/08/27	 HEADER OF NANO-FIT, D/R, CLIP, VERTICAL POWER CONNECTOR		
	GENERAL TOLERANCES (UNLESS SPECIFIED) ANGULAR TOL ± 3.0° 4 PLACES ± 3 PLACES ± 0.1 2 PLACES ± 0.2 1 PLACE ± 0.3 0 PLACES ±	INITIAL REVISION: DRWN: GLLI 2020/02/21 APPR: YXZHENG 2020/08/27			
	DRAFT WHERE APPLICABLE MUST REMAIN WITHIN DIMENSIONS THIRD ANGLE PROJECTION DRAWING: A3-SIZE SERIES: 105312 MATERIAL NUMBER: CUSTOMER: GENERAL MARKET SHEET NUMBER: 3 OF 5				

		4 CKT	6 CKT	8 CKT	10 CKT
BLACK					
NATURAL					
		12 CKT	14 CKT	16 CKT	
BLACK					
NATURAL					

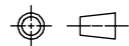
THIS DRAWING CONTAINS INFORMATION THAT IS PROPRIETARY TO MOLEX ELECTRONIC TECHNOLOGIES, LLC AND SHOULD NOT BE USED WITHOUT WRITTEN PERMISSION													
QUALITY SYMBOLS  = 0  = 0  = 0  = 0  = 0  = 0  = 0  = 0		EC NO: 644052 DRWN: GLLI CHK'D: YXZHENG APPR: YXZHENG		2020/08/26 2020/08/27 2020/08/27		GENERAL TOLERANCES (UNLESS SPECIFIED) ANGULAR TOL ± 3.0 ° 4 PLACES ± 3 PLACES ± 0.1 2 PLACES ± 0.2 1 PLACE ± 0.3 0 PLACES ±		DRAFT WHERE APPLICABLE MUST REMAIN WITHIN DIMENSIONS		DIMENSION UNITS: mm SCALE: 3:1 DRWN BY: GLLI DATE: 2014/07/16 CHK'D BY: DATE: APPR BY: AYIN DATE: 2015/04/08 DRAWING SIZE: A3 THIRD ANGLE PROJECTION: 		<div style="text-align: center;">molex[®]</div> HEADER OF NANO-FIT, D/R, CLIP, VERTICAL POWER CONNECTOR PRODUCT CUSTOMER DRAWING SERIES: 105312 MATERIAL NUMBER: SEE SHEET 3 CUSTOMER: GENERAL MARKET DOCUMENT NUMBER: 1053122100-SD DOC TYPE: PSD DOC PART: 000 SHEET NUMBER: 4 OF 5	

NOTES FOR ALL PARTS

1> MATERIAL:
 HOUSING: LCP, UL 94V-0.
 TERMINAL: BRASS.
 SOLDER CLIP: BRASS.

2> PLATING FINISHED:
 TERMINAL:
 CONTACT AREA: a. REFLOW MATTE TIN 1.5MICRONS MIN;
 b. GOLD 0.38 MICRONS MIN;
 c. GOLD 0.76 MICRONS MIN.
 SOLDER AREA: TIN 1.5 MICRONS MIN, UNDER PLATING NICKEL 1.25 MICRONS MIN.
 SOLDER CLIP: TIN 2.5 MICRONS MIN, UNDER PLATING NICKEL 1.25 MICRONS MIN.

3> PRODUCT SPECIFICATION: PS-105300-100.
 4> PACKAGE: TAPE REEL, 1053122000-PK.
 5> PRODUCT MATE WITH SERIES OF 105308(RECEPTACLE), 105300(CRIMP TERMINAL).
 6> PARTS CONFORM TO CLASS 'B'REQUIREMENTS OF COSMETIC SPECIFICATION PS-45499-002.
 7> DISCOLORATION IN THE BANDOLIER PIN CARRIER AREA OF THE PIN IS INHERENT TO THE PLATING PROCESS AND IS DUE TO THE MASKING DEFECT OF THE CARRIER, THIS DISCOLORATION IS IN A NON-FUNCTION AREA OF THE PIN AND WILL NOT AFFECT THE PERFORMANCE OF THE HEADER ASSEMBLY.

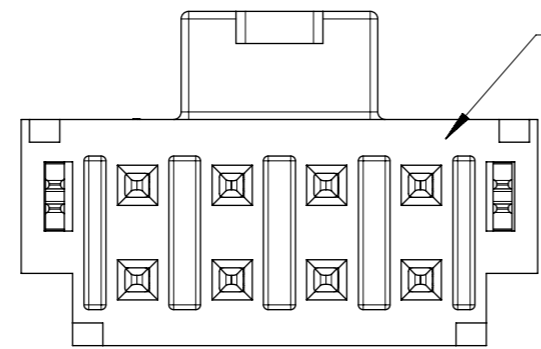

IF ANY NUMBER MARK APPEARS ON THIS SURFACE, PLEASE DISREGARD IT, IT IS NO ANY FUCTION AND NO ANY RELATION TO PIN NUMBER, IT IS JUST FOR MOLDING IDENDIFICATION.

QUALITY SYMBOLS ▽ = 0 ▽ = 0 ▽ = 0 ▼ = 0 ▽ = 0 ⊗ = 0 ■ = 0 ▽ = 0	THIS DRAWING CONTAINS INFORMATION THAT IS PROPRIETARY TO MOLEX ELECTRONIC TECHNOLOGIES, LLC AND SHOULD NOT BE USED WITHOUT WRITTEN PERMISSION																			
	EC NO: 644052 DRWN: GLLI CHK'D: YXZHENG APPR: YXZHENG	2020/08/26		2020/08/27		2020/08/27		GENERAL TOLERANCES (UNLESS SPECIFIED)		DIMENSION UNITS		SCALE								
		ANGULAR TOL ± 3.0 °		4 PLACES ±		3 PLACES ± 0.1		2 PLACES ± 0.2		1 PLACE ± 0.3		0 PLACES ±								
		DRAFT WHERE APPLICABLE MUST REMAIN WITHIN DIMENSIONS		mm		mm		DRWN BY		DATE		GLLI 2020/02/21								
				CHK'D BY		DATE		APPR BY		DATE		YXZHENG 2020/08/27								
				DRAWING SIZE		THIRD ANGLE PROJECTION		A3												
	molex® HEADER OF NANO-FIT, D/R, CLIP, VERTICAL POWER CONNECTOR										PRODUCT CUSTOMER DRAWING									
	SERIES		MATERIAL NUMBER				CUSTOMER				105312		SEE SHEET 3		GENERAL MARKET					
	DOCUMENT NUMBER						DOC TYPE		DOC PART		SHEET NUMBER		1053122100-SD		PSD		000		5 OF 5	