

TeSys™ VLS

Disconnect Switches

16–125 A

Catalog
9400CT1601R07/20
2020



CONTENTS

Three-pole switch disconnectors	4
Fourth pole add on	6
Add-on blocks and accessories	12
Dimensions	18
Wiring diagrams	22
Technical specifications	23

TeSys™ VLS Disconnect Switches
Disconnect Switches, 16–125 A

Disconnect Switches, 16–125 A



- Versions: DIN rail mounting, door mounting, and rear mounting
- Wide range of accessories
- Changeover switches
- Conforming to UL60947-4-1 (16–63 A) or UL98 (63–125 A) specifications

Table 1: VLS Series, 16–125 A

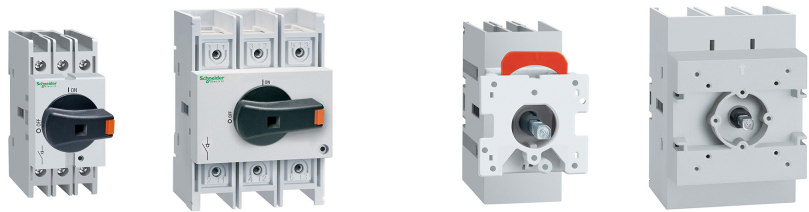

Style	DIN Rail, Rear Mounting								Door Mounting								
	36 mm (1.42 in.)				70 mm (2.75 in.)				36 mm (1.42 in.)				70 mm (2.75 in.)				
Width	16	25	32	40	63	63	80	100	125	16	25	32	40	63	80	100	125
Ampere rating	•	•	•	•	•	•	•	•	•	•	•	•	•	•	•	•	•
Three pole	•	•	•	•	•	•	•	•	•	•	•	•	•	•	•	•	•
4th pole—simultaneous closing		•				•	•	•	•		•			•	•	•	•
4th pole—early-make closing		•				•		•			•				•		
Fuse holder		•															
Mechanical 6-8 pole coupling system			•					•									
Mechanical interlock for line switching			•					•									

Table 2: Interpreting the Catalog Number

Some combinations are not available. Use only for interpreting the catalog number.

Example	VLS	3P	016	R	1
Description	Disconnect switch	1P= 1 pole 3P = 3 poles	016 = 16 A 063 = 63 A 025 = 25 A 080 = 80 A 032 = 32 A 100 = 100 A 040 = 40 A 125 = 125 A	D = Door mounting R = DIN rail mounting	1 = Small size (16–63 A), UL508 2 = Large size (63–125 A), UL98

Example	VLSH	2	S	5	R
Description	Rotary handle	1 = Recessed, 65 x 65 mm 2 = Protruding, 65 x 65 mm 3 = Pistol grip, 75 mm dia. 4 = Protruding, 48 x 48 mm	H = Hole fixing S = Screw mounting	5 = 5 mm shaft opening 7 = 7 mm shaft opening	B = Black BC = Black, changeover BD = Black, defeatable R = Red RD = Red, defeatable

Product Overview



Compact Size

The three-pole 16–63 A disconnect switches are made up of a single unit body, a mere 36 mm (1.4 in.) wide, while those rated 63–125 A are only 70 mm (2.8 in.) wide.

Accessory Flexibility

Mounting and removal of the fourth pole and add-on blocks are simple and quick operations with no need for tools.

Certifications

All VLS disconnect switches are certified by cCSAus and are UL Listed for Canada and USA. The 16–63 A types are certified according to UL60947-4-1/CSA 22.2 n° 60947-4-1-14 while the 63–125 A types to UL98/CSA 22.2 n° 4 standards.



Features

Side Mount Add-on Fourth Pole

Simultaneous or early-make contact operation of the fourth pole with respect to the disconnect switch poles.

Add-on Auxiliary Contacts

One add-on block suitable for use with all eight ratings of disconnect switches, having simultaneous operation with the switch poles. Includes versions with an early-break NO contact.



Maximum Combinations

On each disconnect switch, mount up to four auxiliary contacts, or three auxiliary contacts plus a fourth pole (two blocks on the right and two on the left). The ground and neutral terminals and fuse holder can also be added.

IP65 Padlockable Handles

Offers a wide range of selector or pistol grip handles, with screw or ring (hole) mounting. All handles are equipped with a built-in padlockable mechanism.

VLSH2H5R selector handles snap onto the 16–40 A door-mounting disconnect switches with no need for tools.

Handle Adaptability

The predrilled mounting holes in the front handle plate make it easier to replace disconnect switches in the field without additional drilling.

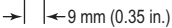

Defeatable UL60947-4-1 Handle Version

UL60947-4-1 standards require internal panel inspection by authorized personnel, with power applied. For rear mounting devices, selector and lever handles are available with a UL60947-4-1 feature as part of the operating handle, to provide a defeat function when the disconnect switch is closed (that is, in the On position).

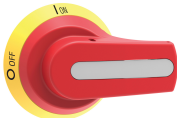

6 and 8 Pole Version

A mechanical coupling system is available for the 16–125 A disconnect switches for DIN rail mounting, to allow for 6- or 8-pole disconnectors, along with a mechanical interlock mechanism for the line changeover function (I – O – II).

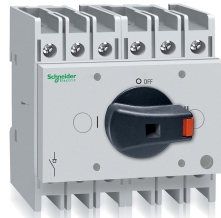

Fuse Holders

A three-pole fuse holder can be added to 16–32 A disconnect switches for DIN rail mounting, to provide a single compact unit. The fuse can be accessed only when the disconnect is in the Off position. Fuses: UL listed, 30 A, Class CC.



Reduced Handle Thickness

VLSH1S5R and VLSH1S5B handles are only 23 mm (0.9 in.) thick.

Switch Status Indication

The open or closed state of the switch is clearly visible at a distance thanks to the simple and modern design of the handle.

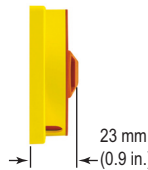

DIN Rail Mounting

The disconnect switch is mounted and removed from the 35 mm (IEC/EN 60715) DIN rail by simply pressing it downward, with no need for tools.

Slide-Resistant Rubber Insert

A rubber insert helps prevent the disconnect switches from sliding on the DIN rail, even when they are out of tolerance or mounted vertically.



Terminal Adaptability

Terminals can accept solid or stranded wire in either metric or AWG sizes. They can withstand high tightening torques as specified on the device.

High IEC Capability in AC23

Offers high rated currents (I_e) in AC23 at 690 Vac.

Modularity

The disconnect switches can be mounted in modular panels.

TeSys™ VLS Disconnect Switches

Three-Pole Disconnect Switches

Three-Pole Disconnect Switches

Table 3: General Specifications

IEC ampere ratings	16–125 A
Available versions	<ul style="list-style-type: none"> DIN rail mounting Door mounting Rear mounting: use the DIN rail mounting disconnect switch, and separately purchase the handle and shaft extension. See pages 14–17.
Size	Compact and modular
Mounting	Screw or 35 mm DIN rail (IEC/EN 60715)
Locking	Padlockable in 0 position with no extra accessory

Table 4: Operational Specifications

IEC rated insulation voltage U_i	1000 V
IEC rated impulse withstand U_{imp}	8 kV
Electrical life in IEC AC21A	<ul style="list-style-type: none"> 100,000 cycles for VLS3P016–VLS3P040 15,000 cycles for VLS3P063R1 30,000 cycles for VLS3P063–VLS3P125
Mechanical life	<ul style="list-style-type: none"> 100,000 cycles for VLS3P016–VLS3P040 and VLS3P063R1 30,000 cycles for VLS3P063–VLS3P125

Table 5: Selection—Three-Pole Disconnect Switches

Catalog number	IEC conventional free air thermal current (I _{th}) AC21A (≤690V) (A)	IEC rated operational current (I _e) AC22A (≤690V) AC23A (≤415V) (A)	Qty per package	Weight, kg (lb)
----------------	--	---	-----------------	-----------------

DIN rail mounting version, complete with black handle. For rear-mounting version, separately purchase the handle and shaft extension. Refer to pages 14 and 16.

VLS3P016R1	16	16	1	0.146 (0.32)
VLS3P025R1	25	25	1	0.146 (0.32)
VLS3P032R1	32	32	1	0.146 (0.32)
VLS3P040R1	40	40	1	0.146 (0.32)
VLS3P063R1	63	45	1	0.148 (0.33)
VLS3P063R2	63	63	1	0.388 (0.86)
VLS3P080R2	80	80	1	0.388 (0.86)
VLS3P100R2	100	100	1	0.388 (0.86)
VLS3P125R2	125	125	1	0.388 (0.86)

Door-mounting version, complete with shaft. Separately purchase the handle. Refer to page 14.

VLS3P016D1	16	16	1	0.170 (0.37)
VLS3P025D1	25	25	1	0.170 (0.37)
VLS3P032D1	32	32	1	0.170 (0.37)
VLS3P040D1	40	40	1	0.170 (0.37)
VLS3P063D2	63	63	1	0.404 (0.89)
VLS3P080D2	80	80	1	0.404 (0.89)
VLS3P100D2	100	100	1	0.404 (0.89)
VLS3P125D2	125	125	1	0.404 (0.89)

Strokes of VLS switch poles

	Travel 0 → 1	0°	30°	60°	90°
VLS3P016R1–VLS3P063R1				60°	
VLS3P016D1–VLS3P040D1				60°	
VLS3P063R2–VLS3P125R2			55°		
VLS3P063D2–VLS3P125D2			55°		

Off On



VLS3P016R1–
VLS3P063R1



VLS3P063R2–
VLS3P125R2

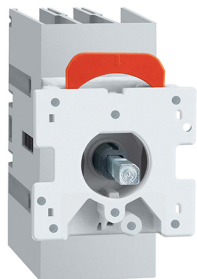

VLS3P016D1–
VLS3P040D1

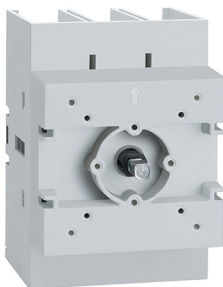

VLS3P063D2–
VLS3P125D2

TeSys™ VLS Disconnect Switches Three-Pole Disconnect Switches

Table 6: Certifications and Compliance (● = certification obtained)

Catalog number	cULus per UL60947-4-1 / CSA C22.2 n° 60947-4-1-14 UL Listed (File E487906)	cULus per UL98 / CSA C22.2 n° 4 UL Listed (File E487907)	IEC/EN 60947-1, IEC/EN 60947-3, UL60947-4-1, UL98, CSA C22.2
VLS3P016R1–VLS3P040R1	●	—	Compliant
VLS3P063R1	●	—	
VLS3P016D1–VLS3P040D1	●	—	
VLS3P063R2–VLS3P125R2	—	●	
VLS3P063D2–VLS3P125D2	—	●	

Table 7: UL/CSA Ratings

Catalog number	Horsepower						General use at 600 Vac (A)	Short-circuit rating at 600 Vac (kA)	Max. fuse rating at 600 V (A)
	1 phase		3 phase						
	120 V	240 V	200–208 V	240 V	480 V	600 V			
UL60947-4-1 and CSA 22.2 n° 60947-4-1-14 [1]									
VLS3P016**	1	2	5	5	10	10	16	5	30 (Type RK5)
VLS3P025**	1.5	3	7.5	7.5	15	20	25	5	30 (Type RK5)
VLS3P032**	2	5	10	10	20	20	32	5	45 (Type RK5)
VLS3P040**	2	5	10	15	20	25	40	5	45 (Type RK5)
VLS3P063R1	2	7.5	10	15	30	30	60	5	45 (Type RK5)
UL98 and CSA C22.2 n° 4 [2]									
VLS3P063**	3	7.5	20 [3]	20	40	40	60	50	60
VLS3P080**	3	10	25 [3]	25	40	40	100	50	100
VLS3P100**	5	10	30 [3]	30	50	50	100	50	100
VLS3P125**	7.5	10	30 [3]	30	60	60	100	50	100

[1] Ratings are valid for VLS3P***R• and VLS3P***D• types, according to UL60947-4-1 and CSA 22.2 n° 60947-4-1-14. UL Listed for USA and Canada (cULus - File E487907) as Manual Motor Controllers, while the UL designation is "General Purpose Switch. Interrupter Usage General" and "Suitable As Motor Disconnect."

[2] Ratings are valid for VLS3P***R• and VLS3P***D• types, according to UL98 and CSA 22.2 n° 4. UL Listed for USA and Canada (cULus - File E487907) as Open Type Switches – Open type unfused switch, while UL designation is "General Purpose Switch. Interrupter Usage General."

[3] Voltage value is not considered in UL98 / CSA 22.2 n° 4 standards, and so is not indicated in the UL product marking.

Fourth Pole Add-on

Table 8: General Specifications—Fourth Pole Add-on

IEC ampere ratings	16–125 A
Available versions	<ul style="list-style-type: none"> • DIN rail mounting • Door mounting • Simultaneous closing with switch poles • Early-make closing with respect to switch poles
Size	Compact and modular

Table 9: Operational Specifications—Fourth Pole Add-on

IEC rated insulation voltage, U_i	1000 V
IEC rated impulse withstand, U_{imp}	8 kV
Electrical life in IEC AC21A	<ul style="list-style-type: none"> • 100,000 cycles for VLS1P040R1S/D1S and VLS1P040R1E/D1E • 15,000 cycles for VLS1P063R1S and VLS1P063R1E • 30,000 cycles for VLS1P063R2S/D2S and VLS1P125R2E/C
Mechanical life	<ul style="list-style-type: none"> • 100,000 cycles for VLS1P040R1S/D1S, VLS1P040R1E/D1E, VLS1P063R1S, and VLS1P063R1E • 30,000 cycles for VLS1P063R2S/D2S – VLS1P125R2S/D2S and VLS1P125R2E/D2E

Table 10: Selection—Fourth Pole Add-on

Catalog number	IEC conventional free air thermal current I_{th} AC21A [1] (s690V) (A)	IEC rated operational current I_e [1] AC22A (s690V), AC23A (s415V) (A)	Qty per package	Weight kg (lb)
Simultaneous closing operation with respect to switch poles				
DIN Rail Mounting (VLS3P***R•)				
VLS1P040R1S [2]	40	40	1	0.045 (0.10)
VLS1P063R1S [3]	63	45	1	0.045 (0.10)
VLS1P063R2S	63	63	1	0.126 (0.28)
VLS1P080R2S	80	80	1	0.126 (0.28)
VLS1P100R2S	100	100	1	0.126 (0.28)
VLS1P125R2S	125	125	1	0.126 (0.28)
Door Mounting (VLS3P***D•)				
VLS1P040D1S [4]	40	40	1	0.045 (0.10)
VLS1P063D2S	63	63	1	0.128 (0.28)
VLS1P080D2S	80	80	1	0.128 (0.28)
VLS1P100D2S	100	100	1	0.128 (0.28)
VLS1P125D2S	125	125	1	0.128 (0.28)
Early-make closing operation with respect to switch poles				
DIN Rail Mounting (VLS3P***R•)				
VLS1P040R1E [2]	40	40	1	0.046 (0.10)
VLS1P063R1E [4]	63	45	1	0.046 (0.10)
VLS1P125R2E [5]	125	125	1	0.116 (0.26)
Door Mounting (VLS3P***D•)				
VLS1P040D1E [4]	40	40	1	0.046 (0.10)
VLS1P125D2E [6]	125	125	1	0.128 (0.28)

[1] See page 5 for UL/CSA ratings, which are the same as the ratings for the corresponding switch types.

[2] For VLS3P016R1–040R1 only.

[3] For VLS3P063R1 only.

[4] For VLS3P016D1–040D1 only.

[5] For VLS3P063R2–125R2 only.

[6] For VLS3P063D2–125D2 only.



VLS1P***R•S
VLS1P***R•E



VLS1P040D1S
VLS1P040D1E

Strokes of VLS poles (switch and add-on pole)

	Travel 0→1	0°	30°	60°	90°
VLS3P016R1/D1–VLS3P040R1/D1, VLS3P063R1				60°	
Main poles					
VLS1P040R1S–VLS1P063R1S				60°	
Simultaneous fourth-pole add on					
VLS1P040R1E/D1E, VLS1P063R1E				55°	
Early-make fourth-pole add on					
VLS3P063R2/D2–VLS3P125R2/D2				55°	
Main poles					
VLS1P063R2S/D2S–VLS1P125R2S/D2S				55°	
Simultaneous fourth-pole add on					
VLS1P125R2E/D2E				48°	
Early-make fourth-pole add on					
	Off				On

Table 11: Certifications and Compliance for the Fourth Pole Add-on Blocks in Table 10 (● = certification obtained)

Catalog number	cULus per UL60947-4-1 / CSA C22.2 n° 60947-4-1-14 UL Listed (File E487906)	Certification Standard	
		cULus per UL98 / CSA C22.2 n° 4 UL Listed (File E487907)	IEC/EN 60947-1, IEC/EN 60947-3, UL60947-4-1, UL98, CSA C22.2
VLS1P040R1E, VLS1P040R1S	●	—	Compliant
VLS1P063R1E, VLS1P063R1S	●	—	
VLS1P040D1E, VLS1P040D1S	●	—	
VLS1P125R2E, VLS1P125D2E	—	●	
VLS1P063R2S–VLS1P125R2S	—	●	
VLS1P063D2S–VLS1P125D2S	—	●	

TeSys™ VLS Disconnect Switches
Sequence and Maximum Combination of Add-on Blocks

Sequence and Maximum Combination of Add-on Blocks

DIN Rail Mounting Disconnect Switches

Table 12: VLS3P016R1–VLS3P040R1 (DIN Rail Mounting)

VLS1NR1	VLS1GR1	VLSA11RS	VLSA10R1E	VLS1P040R1E VLS1P040R1S		VLS1P040R1E VLS1P040R1S	VLSA10R1E	VLSA11RS	VLS1GR1	VLS1NR1
1	1	1	—	1	VLS3P016R1 VLS3P025R1 VLS3P032R1 VLS3P040R1	—	—	2	1	1
1	1	2	—	—		1	—	1	1	1
1	1	1	—	1		—	1	1	1	1
1	1	1	1	—		1	—	1	1	1
1	1	1	1	—		—	—	2	1	1
1	1	2	—	—		—	1	1	1	1
1	1	2	—	—		—	—	2	1	1
1	1	—	—	—		1	—	—	1	1
1	1	—	—	1		—	—	—	1	1
1	1	—	—	—		—	—	—	1	1

Table 13: VLS3P063R1 (DIN Rail Mounting)

VLS1NR1	VLS1GR1	VLSA11RS	VLSA10R1E	VLS1P063R1E VLS1P063R1S		VLS1P063R1E VLS1P063R1S	VLSA10R1E	VLSA11RS	VLS1GR1	VLS1NR1
1	1	1	—	1	VLS3P063R1	—	—	2	1	1
1	1	2	—	—		1	—	1	1	1
1	1	1	—	1		—	1	1	1	1
1	1	1	1	—		1	—	1	1	1
1	1	1	1	—		—	—	2	1	1
1	1	2	—	—		—	1	1	1	1
1	1	2	—	—		—	—	2	1	1
1	1	—	—	—		1	—	—	1	1
1	1	—	—	1		—	—	—	1	1
1	1	—	—	—		—	—	—	1	1

TeSys™ VLS Disconnect Switches Sequence and Maximum Combination of Add-on Blocks

Table 14: VLS3P063R2–VLS3P125R2 (DIN Rail Mounting)

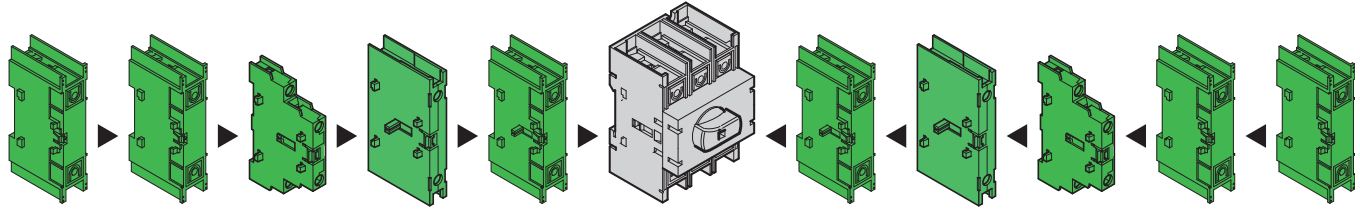

VLS1NR2	VLS1GR2	VLSA11RS	VLSA10R2E	VLS1P125R2E VLS1P...R•S	VLS3P063R2 VLS3P080R2 VLS3P100R2 VLS3P125R2	VLS1P125R2E VLS1P...R•S	VLSA10R2E	VLSA11RS	VLS1GR2	VLS1NR2	
—	—	1	—	1		—	—	—	2	—	—
—	—	2	—	—		1	—	—	1	—	—
—	—	1	—	1		—	1	—	1	—	—
—	—	1	1	—		1	—	—	1	—	—
—	—	1	1	—		—	—	—	2	—	—
—	—	2	—	—		—	1	—	1	—	—
—	—	2	—	—		—	—	—	2	—	—
1	1	—	—	—		1	—	—	—	1	1
1	1	—	—	1		—	—	—	—	1	1
1	1	—	—	—	—	—	—	—	1	1	

Door Mounting Disconnect Switches

Table 15: VLS3P016D1–VLS3P040D1 (Door Mounting)

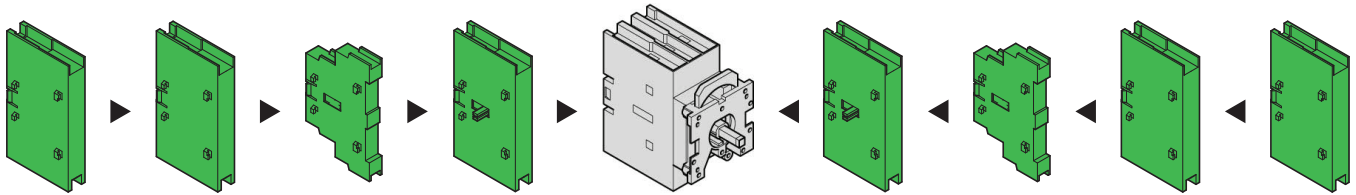

VLS1ND1	VLS1GD1	VLSA11DS	VLS1P040D1E VLS1P040D1S	VLS3P016D1 VLS3P025D1 VLS3P032D1 VLS3P040D1	VLS1P040D1E VLS1P040D1S	VLSA11DS	VLS1GD1	VLS1ND1	
1	1	1	1		—	—	1	1	1
1	1	1	—		1	1	1	1	1
1	1	—	1		—	—	1	1	1
1	1	1	—		—	1	—	1	1
1	1	—	—		—	—	—	1	1

TeSys™ VLS Disconnect Switches

Sequence and Maximum Combination of Add-on Blocks

Table 16: VLS3P063D2–VLS3P125D2 (Door Mounting)

VLS1ND2	VLS1GD2	VLSA11DS	VLS1P125D2E VLS1P125D2S	VLS3P063D2 VLS3P080D2 VLS3P100D2 VLS3P125D2	VLS1P125D2E VLS1P125D2S	VLSA11DS	VLS1GD2	VLS1ND2
—	—	1	1		—	1	—	—
—	—	1	—	1	1	—	—	
1	1	—	1	—	—	1	—	
—	—	1	—	1	—	1	1	
—	—	1	—	—	1	—	—	
1	1	—	—	—	—	1	1	

Mechanical Coupling and Mechanical Interlock for Line Changeover

Table 17: VLS3P016R1–VLS3P040R1, VLS8C1–VLS8M1 (Rear Mounting)

VLS1NR1	VLS1GR1	VLSA11RS	VLSA10R1E	VLS1P040R1E VLS1P040R1S	VLS8C1–VLS8M1	VLS1P040R1E VLS1P040R1S	VLSA10R1E	VLSA11RS	VLS1GR1	VLS1NR1	
1	1	1	—	1	VLS3P016R1 + VLS3P016R1 VLS3P025R1 + VLS3P025R1 VLS3P032R1 + VLS3P032R1 VLS3P040R1 + VLS3P040R1	1	—	1	1	1	
1	1	1	—	1		—	—	2	1	1	
1	1	2	—	—		1	—	1	1	1	
1	1	1	—	1		—	1	—	1	1	
1	1	1	1	—		—	—	2	1	1	
1	1	2	—	—		—	1	—	1	1	
1	1	2	—	—		—	—	2	1	1	
1	1	—	—	1		—	1	—	—	1	1
1	1	—	—	—		—	—	—	—	1	1

TeSys™ VLS Disconnect Switches Sequence and Maximum Combination of Add-on Blocks

Table 18: VLS3P063R1 + VLS8C1–VLS8M1 (Rear Mounting)

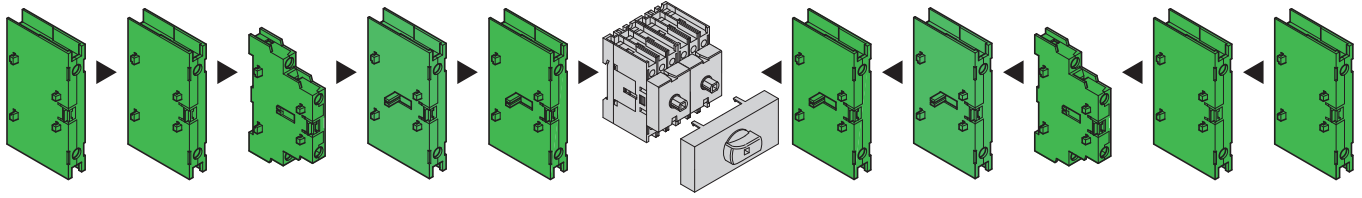

VLS1NR1	VLS1GR1	VLSA11RS	VLSA10R1E	VLS1P063R1E VLS1P063R1S	VLS8C1– VLS8M1	VLS1P063R1E VLS1P063R1S	VLSA10R1E	VLSA11RS	VLS1GR1	VLS1NR1	
1	1	1	—	1	VLS3P063R1 + VLS3P063R1	1	—	1	1	1	
1	1	1	—	1		—	—	2	1	1	
1	1	2	—	—		1	—	1	1	1	
1	1	1	—	1		—	1	1	1	1	
1	1	1	1	—		1	—	1	1	1	
1	1	1	1	—		—	—	2	1	1	
1	1	2	—	—		—	1	1	1	1	
1	1	2	—	—		—	—	2	1	1	
1	1	—	—	1		—	1	—	—	1	1
1	1	—	—	—		—	—	—	—	1	1

Table 19: VLS3P063R2–VLS3P125R2 + VLS8C2–VLS8M2 (Rear Mounting)

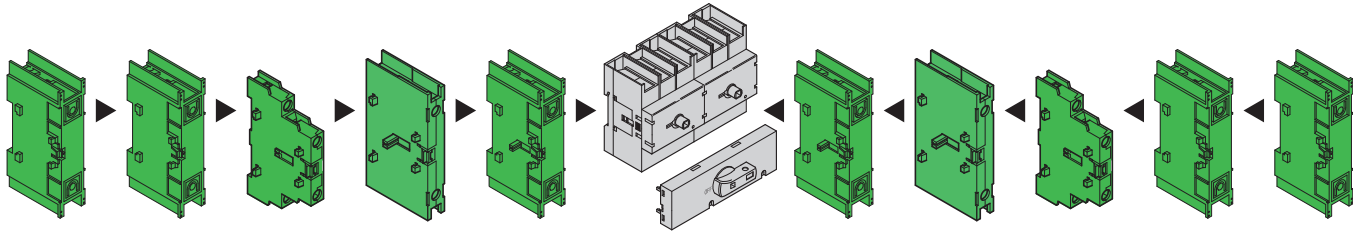

VLS1NR2	VLS1GR2	VLSA11RS	VLSA10R2E	VLS1P125R2E VLS1P***R*S	VLS8C2 - VLS8M2	VLS1P125R2E VLS1P***R*S	VLSA10R2E	VLSA11RS	VLS1GR2	VLS1NR2	
—	—	1	—	1	VLS3P063R2 + VLS3P063R2 VLS3P080R2 + VLS3P080R2 VLS3P100R2 + VLS3P100R2 VLS3P125R2 + VLS3P125R2	1	—	1	—	—	
—	—	1	—	1		—	—	2	—	—	
—	—	2	—	—		1	—	1	—	—	
—	—	1	—	1		—	1	1	—	—	
—	—	1	1	—		—	—	2	—	—	
—	—	2	—	—		—	1	1	—	—	
—	—	2	—	—		—	—	2	—	—	
1	1	—	—	1		—	1	—	—	1	1
1	1	—	—	—		—	—	—	—	1	1

Accessories

Add-on Blocks



VLSA11RS VLSA11DS



VLSA10R1E

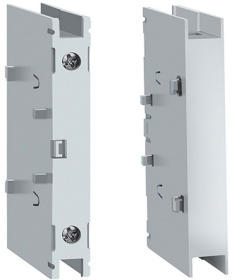

VLS1NR• VLS1GR• VLS1ND• VLS1GD•



VLS8C• VLS8M•

Table 20: Operational Specifications

Auxiliary contacts	
IEC conventional free air thermal current (I _{th})	10 A
UL/CSA and IEC/EN 60947-5-1 designation	A600-Q600
Tightening torque	0.8 N•m (7.1 lb-in.)
Other devices	
Tightening torque	VLS1NR1/D1, VLS1GR1/D1 terminals: 1.8–2 N•m (16–18 lb-in) VLS1NR2/D2, VLS1GR2/D2 terminals: 5–6 N•m (45–54 lb-in) VLS8C1/C2, VLS8M1/M2: mounting: 0.5 N•m (4.4 lb-in) extension with handle: 0.8 N•m (7.1 lb-in)

Table 21: Selection—Add-on Blocks

Catalog number	Specifications	Qty per package	Weight kg (lb)
Auxiliary contacts, simultaneous operation with respect to switch poles			
VLSA11RS	1NO+1NC for VLS3P***R• and VLS3P063R1	1	0.030 (0.07)
VLSA11DS	1NO+1NC for VLS3P***D•	1	0.030 (0.07)
Auxiliary contacts, early-break operation with respect to switch poles			
VLSA10R1E	1EB (NO) for VLS3P016R1–VLS3P040R1, VLS3P063R1	1	0.035 (0.08)
VLSA10R2E	1EB (NO) for VLS3P063R2–VLS3P125R2	1	0.035 (0.08)
Neutral terminal			
VLS1NR1	For VLS3P016R1–VLS3P040R1, VLS3P063R1	1	0.040 (0.09)
VLS1NR2	For VLS3P063R2–VLS3P125R2	1	0.110 (0.24)
VLS1ND1	For VLS3P016D1–VLS3P040D1	1	0.040 (0.09)
VLS1ND2	For VLS3P063D2–VLS3P125D2	1	0.110 (0.24)
Earth/Ground terminal			
VLS1GR1	For VLS3P016R1–VLS3P040R1, VLS3P063R1	1	0.040 (0.09)
VLS1GR2	For VLS3P063R2–VLS3P125R2	1	0.110 (0.24)
VLS1GD1	For VLS3P016D1–VLS3P040D1	1	0.040 (0.09)
VLS1GD2	For VLS3P063D2–VLS3P125D2	1	0.110 (0.24)
Mechanical interlock for line changeover (I-0-II)			
VLS8C1	For VLS3P016R1–VLS3P040R1, VLS3P063R1, and VLSH2S5BC: □ 5 mm (0.2 in.) [1]	1	0.050 (0.11)
VLS8C2	For VLS3P063R2–VLS3P125R2 and VLSH2S5BC: □ 5 mm (0.2 in.) [1]	1	0.075 (0.17)
Mechanical coupling system for 6–8 pole disconnect switches			
VLS8M1	For VLS3P016R1–VLS3P040R1 and VLS3P063R1: □ 5 mm (0.2 in.) [1]	1	0.050 (0.11)
VLS8M2	For VLS3P063R2–VLS3P125R2: □ 7 mm (0.3 in.) [2]	1	0.075 (0.17)

[1] Use VLSS shaft extensions.

[2] Use VLSH3S7RD handles and VLSS***7 extensions for a rear-mounting version.

Figure 1: Transformation of the DIN rail mounting version into the rear mounting version

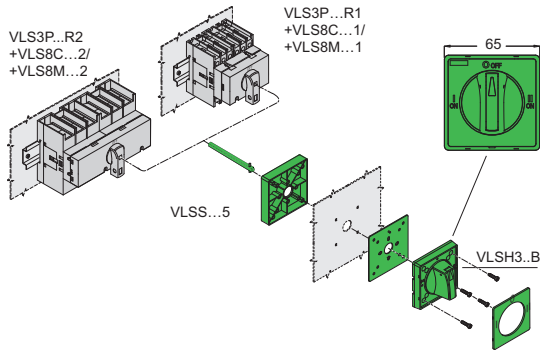

Strokes of VLS poles (switch with auxiliary contact blocks)

	Travel 0 → 1	0°	30°	60°	90°
VLS3P016R1/D1, VLS3P040R1/D1, VLS3P063R1				60°	
Main poles				60°	
VLSA11RS/DS				60°	
Auxiliary contacts (1 NO + 1 NC)	NO				
	NC				
		40°			
VLSA10R1E				60°	
Auxiliary contact (1EB – NO early break)				70°	
VLS3P063R2/D2...VLS3P125R2/D2				55°	
Main poles				45°	
VLSA11RS/DS				45°	
Auxiliary contacts (1 NO + 1 NC)	NO				
	NC				
		25°			
VLSA10R2E				55°	
Auxiliary contact (1EB – NO early break)				65°	
	Off				On

Table 22: Certifications and Compliance (● = certification obtained)

Catalog number	cULus per UL60947-4-1 / CSA C22.2 n° 60947-4-1-14 UL Listed (File E487906)	cULus per UL98 / CSA C22.2 n° 4 UL Listed (File E487907)
VLSA11RS/DS	UL Listed, cULus File E478582	—
VLSA10R1E	CSA C22.2 n° 14-10	—
VLSA10R2E		—
VLS1NR1/D1	●	—
VLS1NR2/D2	—	●
VLS1GR1/D1	●	—
VLS1GR2/D2	—	●
VLS8C1/M1	●	—
VLS8C2/M2	—	●
VLSH1S5R/B	●	●
VLSH2S5R/B	●	●
VLSH2H5R/B	●	●
VLSH4S5R/B	●	●
VLSH2S5RD/BD	●	●
VLSH3S7RD/BD	—	●
VLSH2H5BC	●	●
VLSHA7	—	●

Compliant with standards: IEC/EN 60947-1, IEC/EN 60947-3, IEC/EN 60947-5-1, UL60947-4-1, UL98, CSA C22.2.

NOTE: VLSH1S5R/B and VLSH3S7NRD/BD are UL/CSA Type 1, 12, 3R, 4, and 4X outdoor use with all VLS switch models. VLSH2S5R/B, VLSH2H5R/B, VLSH2H5RD/BD and VLSH2S5BC are UL/CSA Type 1, 12, 3R, 4, and 4X outdoor use with VLS3P016R1/D1–VLS3P040R1/D1 and VLS3P063R1 models, otherwise Type 1 only.

TeSys™ VLS Disconnect Switches Accessories

Rotary Handles



VLSH1S5R (65 x 65 mm)



VLSH2S5R (65 x 65 mm)

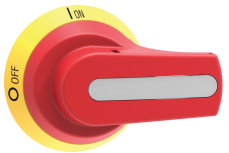

VLSH3S7NRD
(75 mm dia.)



VLSH4S5R (48 x 48 mm)

Table 23: Selection—Rotary Handles

Catalog number	Specifications	Qty per package	Weight, kg (lb)
Door Mounting^[1] and Rear Mounting Handles, Padlockable			
Red/yellow, rotating			
VLSH1S5R	For VLS3P***R• and VLS3P***D•. Screw mounting. Recessed selector. □ 5 mm (0.2 in.) ^[2] . IEC IP65 and NEMA 1, 12, 3R, 4, 4X.	1	0.073 (0.16)
VLSH2S5R	For VLS3P***R• and VLS3P***D•. Screw mounting. Protruding selector. □ 5 mm (0.2 in.) ^[2] . IEC IP65 and NEMA 1, 12, 3R, 4, 4X.	1	0.072 (0.16)
VLSH2H5R	For VLS3P***R• and VLS3P016D1–VLS3P040D1. Ring mounting. Protruding selector. □ 5 mm (0.2 in.) ^[2] ^[3] . IEC IP65 and NEMA 1, 12, 3R, 4, 4X.	1	0.068 (0.15)
VLSH2H5RD	For VLS3P***R•. Ring mounting. Protruding selector with release, defeatable per UL60947-4-1; □ 5 mm (0.2 in.) ^[2] . IEC IP65 and NEMA 1, 12, 3R, 4, 4X.	1	0.064 (0.14)
VLSH3S7NRD	For VLS3P063R2–VLS3P125R2, and VLS8M2. Screw mounting. Pistol grip with release, defeatable per 60947-4-1; □ 7 mm (0.3 in.) ^[4] . IEC IP66 and NEMA 1, 12, 3R, 4, 4X.	1	0.140 (0.31)
VLSH4S5R	For VLS3P***R• and VLS3P***D•. Screw mounting. Protruding selector. 48 mm square. □ 5 mm (0.2 in.) ^[2] . IEC IP65 and NEMA 1, 12, 3R, 4, 4X.	1	0.072 (0.16)
Black, rotating			
VLSH1S5B	For VLS3P***R• and VLS3P***D•. Screw mounting. Recessed selector. □ 5 mm (0.2 in.) ^[2] . IEC IP65 and NEMA 1, 12, 3R, 4, 4X.	1	0.073 (0.16)
VLSH2S5B	For VLS3P***R• and VLS3P***D•. Screw mounting. Protruding selector. □ 5 mm (0.2 in.) ^[2] . IEC IP65 and NEMA 1, 12, 3R, 4, 4X.	1	0.072 (0.16)
VLSH2H5B	For VLS3P***R•, VLS3P063R1, VLS3P016D1–VLS3P040D1. Ring mounting. Protruding selector. □ 5 mm (0.2 in.) ^[2] ^[3] . IEC IP65 and NEMA 1, 12, 3R, 4, 4X.	1	0.068 (0.15)
VLSH2H5BD	For VLS3P***R•. Ring mounting. Protruding selector with release, defeatable per 60947-4-1. □ 5 mm (0.2 in.) ^[2] . IEC IP65 and NEMA 1, 12, 3R, 4, 4X.	1	0.064 (0.14)
VLSH3S7NBD	For VLS3P063R2–VLS3P125R2, and VLS8M2. Screw mounting. Pistol grip with release, defeatable per UL60947-4-1; □ 7 mm (0.3 in.) ^[4] . IEC IP66 and NEMA 1, 12, 3R, 4, 4X.	1	0.140 (0.31)
VLSH2S5BC	For VLS8C• mechanical interlock mechanism (I-O-II). □ 5 mm (0.2 in.) ^[2] . IEC IP65 and NEMA 1, 12, 3R, 4, 4X.	1	0.078 (0.17)
VLSH4S5B	For VLS3P***R• and VLS3P***D•. Screw mounting. Protruding selector. □ 5 mm (0.2 in.) ^[2] . IEC IP65 and NEMA 1, 12, 3R, 4, 4X.	1	0.072 (0.16)
Accessories for Rear Mounting Control For VLSH3S7RD and VLSH3S7BD handles.			
VLSHA7	Adapter, □ 7 mm (0.3 in.) for VLS3P063R2–VLS3P125R2.	1	0.010 (0.02)

^[1] Catalog numbers ending in BD or RD are for rear mounting units only.

^[2] For VLS3P***R• disconnect switches, separately purchase VLSS shaft extensions.

^[3] Snap-on mounting of VLS3P016–VLS3P040D1 disconnect switches with the handle.

^[4] Separately purchase the VLSS***7 shaft extension and a VLSHA7 handle having a 7 mm (0.3 in.) square section—not required for VLS8M2.



VLSH2H5B (65 x 65 mm)



VLSH2S5BC (65 x 65 mm)



VLSH4S5B (48 x 48 mm)

Table 24: Operating Specifications

Handle mounting		ring or screw
Mounting handle interaxis (compatible with the pre-existing drillings of the most common types in the marketplace)	VLSH1S5R/B VLSH2S5R/B VLSH2S5BC	36 x 36 mm (1.4 x 1.4 in.) or 48 x 48 mm (1.9 x 1.9 in.)
	VLSH3S7NRD/BD	36 x 36 mm (1.4 x 1.4 in.)
Padlocks		1–3 for all handles Ø4–8 mm (Ø0.2–0.3 in.)
Tightening torque	Mounting ring types	2.3 N•m (20.4 lb-in)
	VLS8M1	0.8 N•m (7 lb-in)
	VLSH3S7NRD/BD	1.5 N•m (13.3 lb-in)
	All others	1 N•m (9 lb-in)
Degree of protection		IEC/EN IP65 for all except VLSH3S7RD/BD with IP66; for UL/CSA ratings, see the Note on page 13.

Figure 2: Changing the DIN rail mounting version for rear mounting

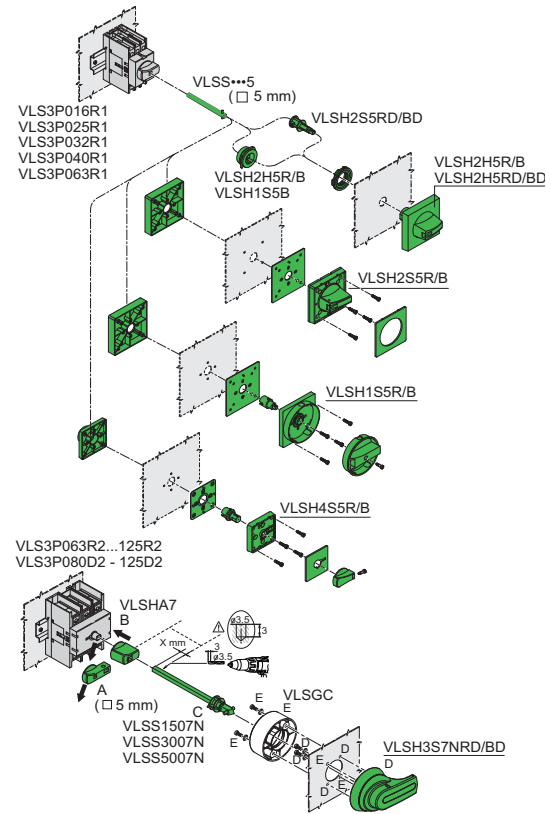
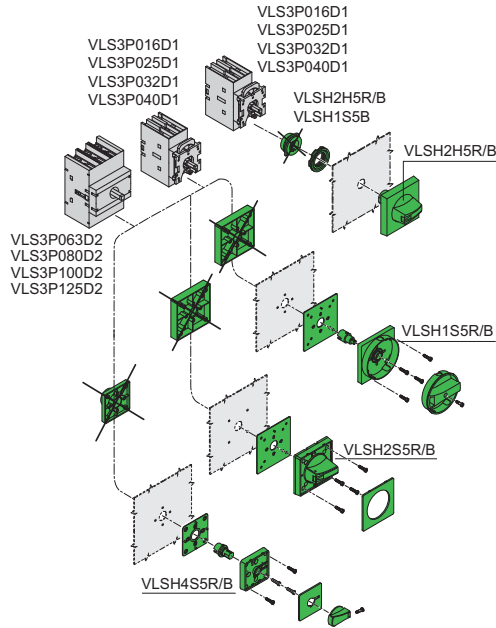

Figure 3: Door mounting version



Certifications and Compliance

See Table 22 on page 13 for details.

Shaft Extensions, Terminal Covers, Fuse Holders, and Fuse Blocks

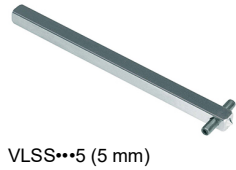

VLSS...7 (7 mm)



VLSCC

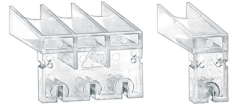

VLSC

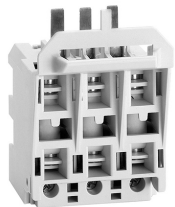

VLSFH1UL

Table 25: Selection—Shaft Extensions, Terminal Covers, Fuse Holders, and Fuse Blocks

Catalog number	Specifications	Qty per package	Weight, kg (lb)
Shaft extension for rear-mounting handles VLSH1S5R–VLSH2H5RD, VLSH1S5B–VLSH2H5BD, VLSH2S5BC; interlocking changeover type VLS8C1, VLS8C2; and mechanical disconnect switch system VLS8M1			
VLSS1505	150 mm long; □ 5 mm (0.2 in.)	1	0.032 (0.07)
VLSS3005	300 mm long; □ 5 mm (0.2 in.)	1	0.068 (0.15)
VLSS5005	500 mm long; □ 5 mm (0.2 in.)	1	0.090 (0.20)
Shaft extension for rear-mounting handles VLSH3S7RD/BD, and mechanical coupling system VLS8M2			
VLSS1507N	150 mm long; □ 7 mm (0.3 in.)	1	0.090 (0.20)
VLSS3007N	300 mm long; □ 7 mm (0.3 in.)	1	0.35 (0.77)
VLSS5007N	500 mm long, □ 7 mm (0.3 in.)	1	0.50 (1.10)
VLSCC	Guide cone for use with pistol grip handles and shafts, □ 75 mm (3 in.)	1	0.10 (0.22)
Set of 2 one-pole terminal covers for fourth pole			
VLSC1P1	For VLS1P040R1S, VLS1P040D1S, VLS1P040R1E, VLS1P040D1E, VLS1P063R1E, VLS1P063R1S	1	0.009 (0.02)
VLSC1P2	For VLS1P063R2S–VLS1P125R2S, VLS1P063D2S–VLS1P125D2S, VLS1P125R2E, VLS1P125D2E	1	0.012 (0.03)
Set of 2 three-pole terminal covers			
VLSC3P1	For VLS3P016R1–VLS3P040R1, VLS3P063R1, VLS3P016D1–VLS3P040D1	1	0.018 (0.04)
VLSC3P2	For VLS3P063R2–VLS3P125R2, VLS3P063D2–VLS3P125D2	1	0.030 (0.07)
Fuse holder/block for disconnect switches			
VLSFH1UL	For VLS3P016R1–VLS3P032R1 (suitable for Class CC fuses)	1	0.135 (0.30)

Table 26: Operational Specifications of Fuse Holder

IEC rated insulation voltage, Ui	1000 V
IEC rated impulse withstand voltage, Uimp	8 kV

- The fuse holder/block connects directly to the disconnect switches.
- Access to fuses only when the disconnect switches are in Off position.

Figure 4: Terminal covers

For disconnect switches

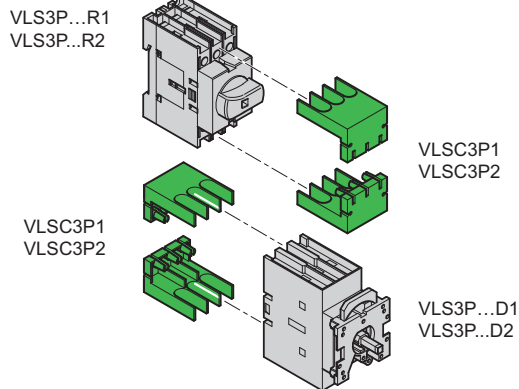

For fourth pole

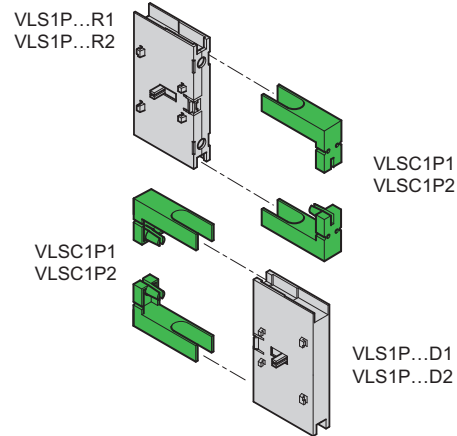

Table 27: Certifications and Compliance (● = certification obtained)

Catalog number	cULus per UL60947-4-1 / CSA C22.2 n° 60947-4-1-14 UL Listed (File E487906)	cULus per UL98 / CSA C22.2 n° 4 UL Listed (File E487907)
VLSS1505, VLSS3005, VLSS5005	●	—
VLSS1507N, VLSS3007N, VLSS5007N	●	—
VLSC1P1, VLSC3P1	—	—
VLSC1P2, VLSC3P2	—	—
VLSFH1UL	●	—
Compliant with standards: IEC/EN 60947-1, IEC/EN 60947-3, UL60947-4-1, UL98, CSA C22.2.		

TeSys™ VLS Disconnect Switches
Dimensions: 16–125 A Disconnect Switches

Dimensions: 16–125 A Disconnect Switches

DIN Rail Mounting Disconnect Switches

VLS3P016R1–VLS3P040R1, VLS3P063R1

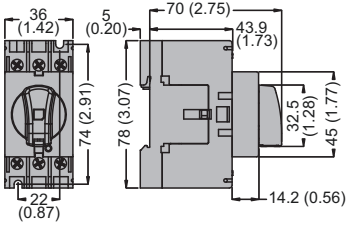

VLS3P063R2–VLS3P125R2

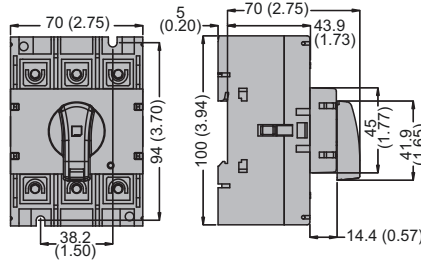

Dim. = mm (in.)

Door Mounting Disconnect Switches

VLS3P016D1–VLS3P040D1

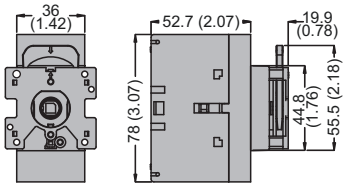

VLS3P063D2–VLS3P125D2

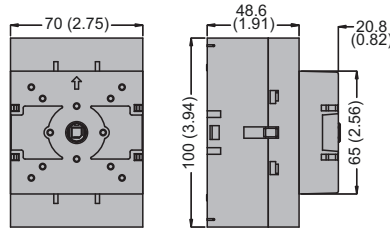

Dim. = mm (in.)

Add-on Blocks and Accessories

For VLS3P016R1–VLS3P040R1, VLS3P063R1

Auxiliary contacts

VLSA11RS, VLSA10R1E

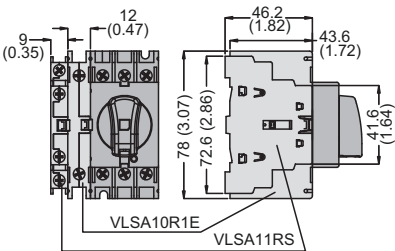

Fourth pole

VLS1P040R1E/R1S, VLS1P063R1E/R1S
 VLS1NR1 neutral, VLS1GR1 ground terminals

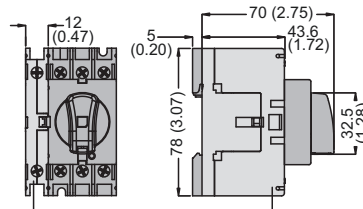

Dim. = mm (in.)

VLS3P016R1, VLS3P025R1, VLS3P032R1, VLS3P040R1, VLS3P063R1, VLSA11RS, VLS3P040R1DC

For VLS3P063R2–VLS3P125R2

Auxiliary contacts

VLSA11RS
 VLSA10R2E

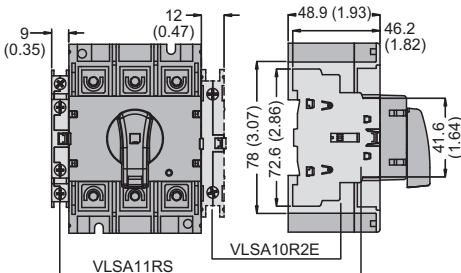

Fourth pole

VLS1P125R2E, VLS1P063R2S–VLS1P125R2S
 VLS1NR2 neutral, VLS1GR2 ground terminals

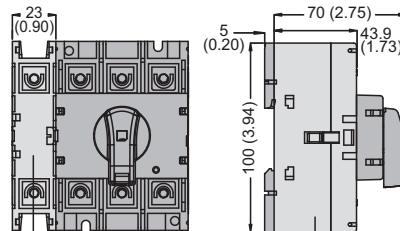

Dim. = mm (in.)

VLS3P063R2, VLS3P080R2, VLS3P100R2, VLS3P125R2, VLSA10R1E, VLSA10R2E, VLS1P063R2S, VLS1P080R2S, VLS1P100R2S, VLS1P125R2S, VLS1P125R2

TeSys™ VLS Disconnect Switches

Dimensions: 16–125 A Disconnect Switches

Mechanical interlock VLS8C1 and mechanical coupling system VLS8M1

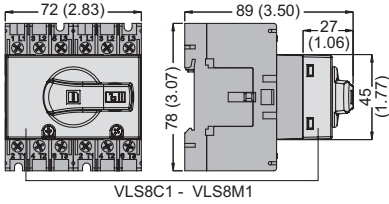

Mechanical interlock VLS8C2 and mechanical coupling system VLS8M2

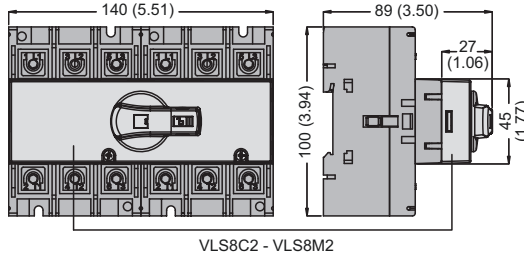

Dim. = mm (in.)

For VLS3P016D1–VLS3P040D1

Auxiliary contacts

VLSA11DS

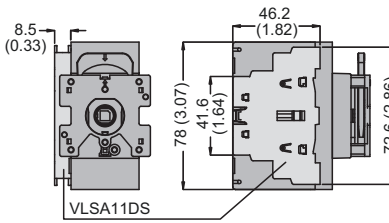

Fourth pole

VLS1P040D1E–VLS1P040D1S

VLS1ND1 neutral, VLS1GD1 ground terminals

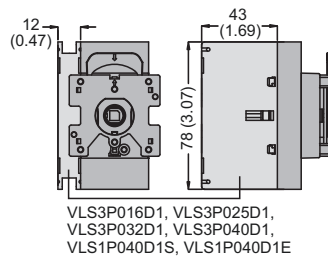

Dim. = mm (in.)

For VLS3P063D2–VLS3P125D2

Auxiliary contacts

VLSA11DS

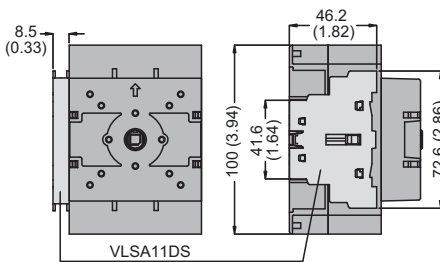

Fourth pole

VLS1P125D2E, VLS1P063D2S–125D2S

VLS1ND2 neutral, VLS1GD2 ground terminals

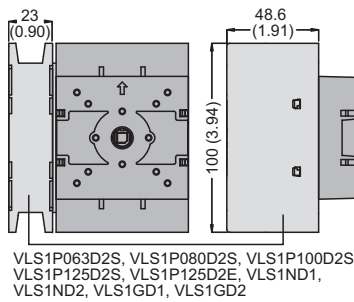

Dim. = mm (in.)

TeSys™ VLS Disconnect Switches

Dimensions: 16–125 A Disconnect Switches

Rotary handles

VLSH1S5R/B

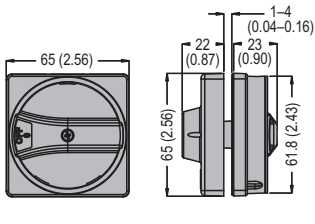

VLSH2S5R/B

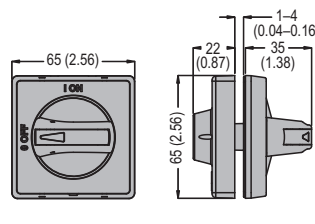

VLSH2H5R/B

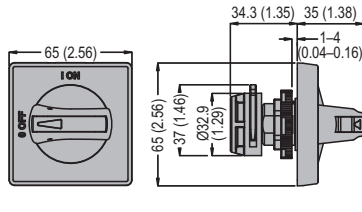

VLSH2H5RD/BD

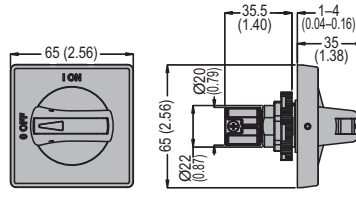

VLSH3S7NRD/BD

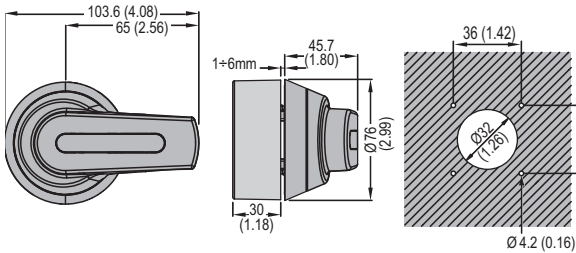

VLSH2S5BC

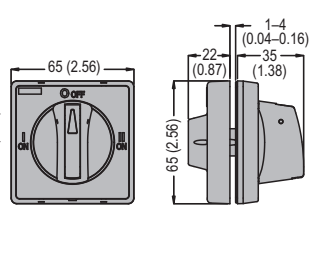

VLSH4S5R/B

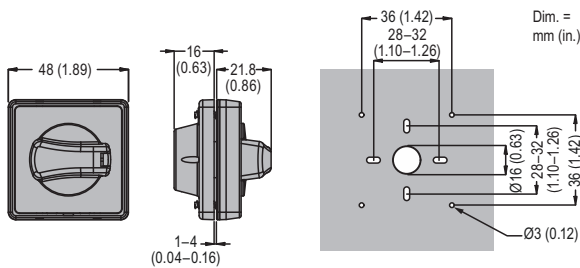
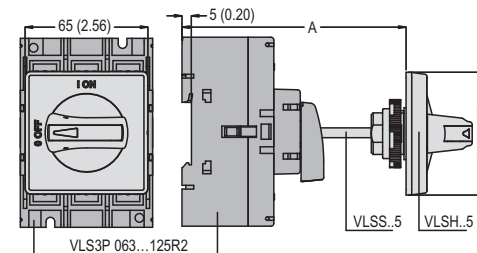
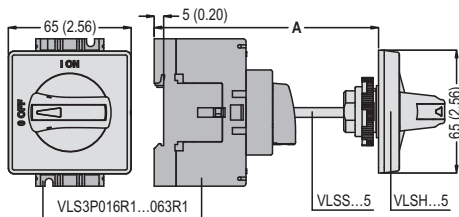

Table 28: Dimension A for VLSS Shaft Extensions (see below)

Extension	Length mm (in.)	Maximum Dimension A, mm (in.)				
		Type of handle				
		VLSH 1S5*	VLSH 2S5*	VLSH 2H5R	VLSH 2H5RD	VLSH 2S5BC
VLSS1505	150 (5.90)	194 (7.64)	192 (7.56)	197 (7.75)	211 (8.31)	192 (7.56)
VLSS3005	300 (11.81)	344 (13.54)	342 (13.46)	347 (13.66)	361 (14.21)	342 (13.46)
VLSS5005	500 (19.68)	544 (21.42)	542 (21.34)	547 (21.53)	561 (22.09)	542 (21.34)

Shaft extensions for rear-mounting handles (for Dimension A, see Table 28)

VLSS



TeSys™ VLS Disconnect Switches

Dimensions: 16–125 A Disconnect Switches

VLSS used with VLS8C1, VLS8C2, and VLS8M1

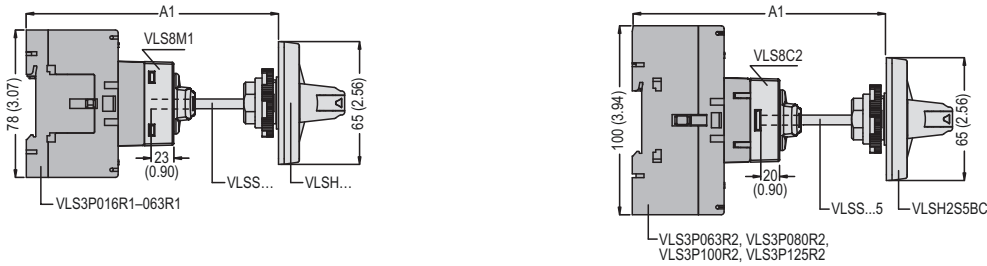

Dim. = mm (in.)

Table 29: Dimension A1 for VLSS used with VLS8C1, VLS8C2, and VLS8M1

Extension	Length mm (in.)	A1 maximum, mm (in.)				
		Used with VLS8M1			Used with VLS8C1/VLS8C2	
		Type of handle				
		VLSH1S5•	VLSH2S5•	VLSH2H5R	VLSH2H5RD	VLSH2S5BC
VLSS1505	150 (5.90)	211 (8.31)	209 (8.23)	214 (8.42)	228 (8.98)	209 (8.23)
VLSS3005	300 (11.81)	361 (14.21)	359 (14.13)	364 (14.33)	378 (14.88)	359 (14.13)
VLSS5005	500 (19.68)	561 (22.09)	559 (22.01)	564 (22.20)	578 (22.75)	559 (22.01)

VLSS•••7N used with VLHA7 and VLSH3S7NRD/BD

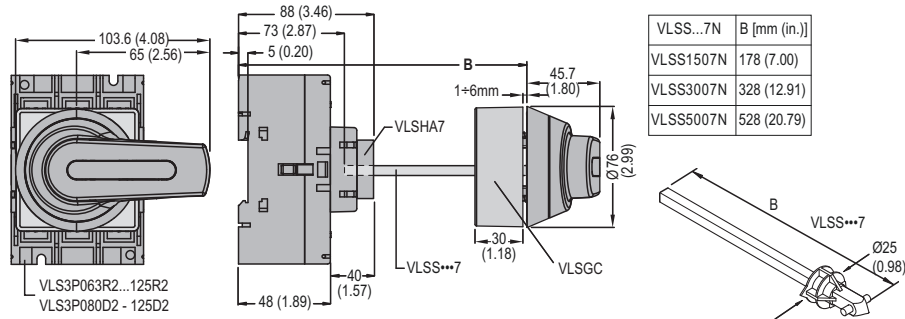

VLSS•••7N used with VLS8M2 and VLSH3S7NRD/BD handle

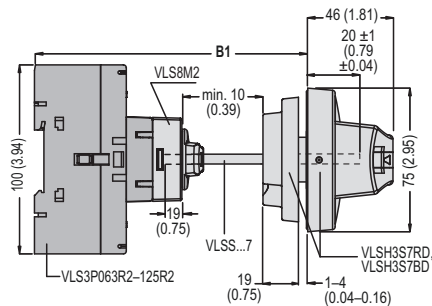

Table 30: Dimensions B and B1 for VLSS•••7

Extension	Length mm (in.)	B	B1
		with VLSH3S7NRD/BD handle	
		mm (in.)	mm (in.)
VLSS1507N	178 (7.00)	118–229 (4.64–9.01)	119–205 (4.68–8.07)
VLSS3007N	328 (12.91)	118–279 (4.64–10.99)	119–255 (4.68–10.03)
VLSS5007N	528 (20.79)	118–379 (4.64–14.92)	119–355 (4.68–13.98)

TeSys™ VLS Disconnect Switches Wiring Diagrams

Terminal Cover Dimensions

VLSC1P1, VLSC3P1

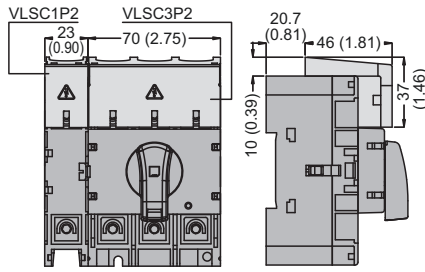
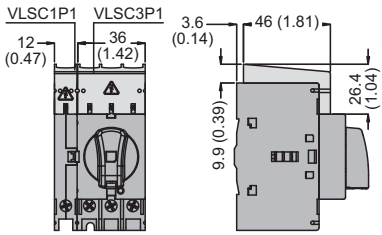

Fuse Holder Dimensions

VLSFH1UL

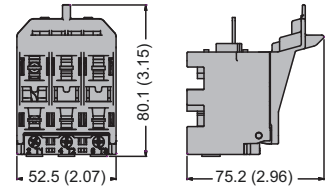

VLSC1P2, VLSC3P2

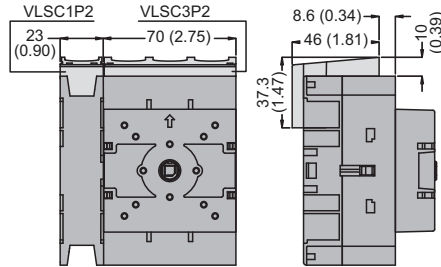
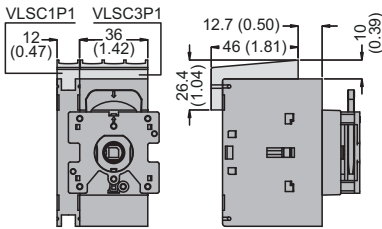

Wiring Diagrams

VLS Disconnect Switches (16–125 A)

Three-pole disconnectors

Fourth pole add-on

VLS3P016... – VLS3P125R2/D2

VLS1P.....S

VLS1P.....E

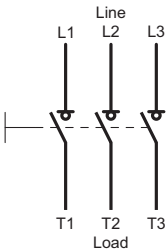

Add-on Blocks and Accessories

Auxiliary contacts

VLSA11•S

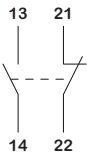

VLSA10R1E–VLSA10R2E



Neutral terminal

VLS1NR1/D1–VLS1NR2/D2



Earth/Ground terminal

VLS1GR1/D1–VLS1GR2/D2



Fuse holder

VLSFH1

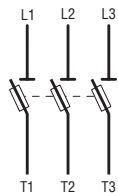

Table 31: Technical Specifications, VLS Range, 16–125 A

Model	3-pole: VLS3P...	016...	025...	032...	040...	063R1	063R2	080...	100...	125...	
	4th pole: VLS1P...	040...	040...	040...	040...	063R1S	063R2S	080...	100...	125...	
Contact Specifications											
IEC conventional free air thermal current, I _{th} (≤40°C)	A	16	25	32	40	63	63	80	100	125	
IEC rated insulation voltage, U _i	V	1000									
IEC rated impulse withstand voltage, U _{imp}	kV	8									
IEC rated operational current, I _e											
AC21A	400 V	A	16	25	32	40	63	63	80	100	125
	500 V	A	16	25	32	40	63	63	80	100	125
	690 V	A	16	25	32	40	63	63	80	100	125
AC22A	400 V	A	16	25	32	40	45	63	80	100	125
	500 V	A	16	25	32	40	45	63	80	100	125
	690 V	A	16	25	32	40	45	63	80	100	125
AC23A	400 V	A	16	25	32	40	45	63	80	100	125
	500 V	A	16	25	25	25	25	63	63	80	100
	690 V	A	16	25	25	25	25	47	47	47	47
IEC rated operational power											
AC23A	400 V	kW	7.5	11	15	18.5	22	30	45	55	55
	690 V	kW	11	22	22	22	22	45	45	45	45
IEC reactive power for capacitor control 400 V	kvar	7.5	10	12.5	15	15	25	30	40	50	
IEC protection against short-circuit											
Rated short-time withstand current (1s), I _{cw}	A rms	800						2500			
Rated conditional short-circuit current	kA rms	50									
With fuse class gG	A	16	25	32	40	63	63	80	100	125	
IEC making capacity (AC23A 400 V)	A	400					450	1250			
IEC breaking capacity (AC23A 400 V)	A	320					360	1000			
Mechanical life	cycles	100,000					100,000	30,000			
Electrical life (IEC AC21A)	cycles	100,000					15,000	30,000			
UL/CSA general use at 600 V	A	16	25	32	40	50	60	100	100	100	
UL/CSA short-circuit rating at 600 V	kA	5	5	5	5	5	10	10	10	10	
UL/CSA fuse class/max rating at 600 V	Type/A	RK5/20	RK5/30	RK5/35	RK5/45	RK5/45	–/100	–/100	–/100	–/100	
UL/CSA HP ratings											
Single phase	120 V	HP	1	1.5	2	2	2	3	3	5	7.5
	240 V	HP	2	3	5	5	7.5	7.5	10	10	10
Three phase	200-208 V	HP	5	7.5	10	10	10	20	25	30	25
	240 V	HP	5	7.5	10	15	15	20	30	30	30
	480 V	HP	10	15	20	20	30	40	40	50	50
	600 V	HP	10	20	20	25	30	40	40	60	40
Terminals											
	Type	Lug clamp ^[1]									
	A mm	5.6 mm (0.22 in.)					12.4 mm (0.49 in.)				
	B mm	6.5 mm (0.26 in.)					10.4 mm (0.41 in.)				
	Screw	M4					M8				
	Tool	Phillips 2					Metric Allen key 4				
Tightening torque											
	N•m	1.8–2					5–6				
	lb-in	16–18					45–54				
Conductor section (solid/stranded)											
	mm ²	0.75–16					4–50				
	AWG	18–6					12–1				
Ambient Conditions											
Temperature	Operating	°C	–25 to +55								
	Storage	°C	–40 to +70								
Maximum altitude	m	3000									
Mounting position	Normal	Vertical									
	Admissible	Any									
Mounting	Screw or 35 mm DIN rail (IEC/EN 60715)										

[1] IEC/EN 60947-1 designation: Pillar terminal.

Schneider Electric USA, Inc.
800 Federal Street
Andover, MA 01810 USA
888-778-2733
www.schneider-electric.us

Schneider Electric and TeSys are trademarks and the property of Schneider Electric SE, its subsidiaries, and affiliated companies. All other trademarks are the property of their respective owners.
9400CT1601R07/20
© 2016–2020 Schneider Electric All Rights Reserved