

## High Power Density Surface Mount Automotive Transient Voltage Suppressors

**DO-220AA (SMP)**

<b>MAJOR RATINGS AND CHARACTERISTICS</b>	
$V_{(BR)}$	6.8 V to 43 V
$P_{PPM}$ (for $V_{(BR)}$ 6.8 V)	250 W
$P_{PPM}$ (for $V_{(BR)}$ 7.5 V - 12 V)	300 W
$P_{PPM}$ (for $V_{(BR)}$ 13 V - 43 V)	400 W
$P_D$	1.0 W
$I_{FSM}$	40 A
$T_J$ max.	185 °C

**FEATURES**

- Very low profile - typical height of 1.0 mm
- Ideal for automated placement
- Unidirection only
- Exclusive patented PAR oxide passivated chip construction
- Excellent clamping capability
- Low incremental surge resistance
- Very fast response time
- Meets MSL level 1, per J-STD-020C
- Solder Dip 260 °C, 40 seconds
- Component in accordance to RoHS 2002/95/EC and WEEE 2002/96/EC

**TYPICAL APPLICATIONS**

Protection for Ics, drive transistors, signal lines of sensor units, and electronic units in consumer, computer, industrial and automotive applications.

**MECHANICAL DATA**

**Case:** DO-220AA (SMP)

Epoxy meets UL-94V-0 flammability rating

**Terminals:** Matte tin plated leads, solderable per J-STD-002B and JESD22-B102D

E3 suffix for commercial grade, HE3 suffix for high reliability grade (AEC Q101 qualified)

**Polarity:** Color band denotes cathode end

<b>MAXIMUM RATINGS</b> ( $T_A = 25$ °C, unless otherwise specified)			
PARAMETER	SYMBOL	VALUE	UNIT
Peak power dissipation with a 10/1000 $\mu$ s waveform <sup>(1)(2)</sup> (Fig. 1 & 3)	$P_{PPM}$	see table next page	W
Peak power pulse current with a 10/1000 $\mu$ s waveform <sup>(1)</sup> (Fig. 1)	$I_{PPM}$	see table next page	A
Power dissipation on infinite heatsink, $T_A = 50$ °C	$P_D$	1.0	W
Peak forward surge current 10 ms single half sine-wave superimposed on rated load	$I_{FSM}$	40	A
Maximum instantaneous forward voltage at 25 A <sup>(3)</sup>	$V_F$	2.5	V
Operating junction and storage temperature range	$T_J, T_{STG}$	- 65 to + 185	°C

**Note:**

(1) Non-repetitive current pulse, per fig. 3 and derated above  $T_A = 25$  °C per Fig. 2

(2) Mounted on P.C.B. with 5.0 x 5.0 mm copper pads attached to each terminal

(3) Pulse test: 300  $\mu$ s pulse width, 1 % duty cycle

# TPSMP6.8 thru TPSMP43A

Vishay General Semiconductor



## ELECTRICAL CHARACTERISTICS ( $T_A = 25\text{ }^\circ\text{C}$ , unless otherwise specified)

DEVICE TYPE	DEVICE MARKING CODE	BREAKDOWN VOLTAGE $V_{(BR)}$ <sup>(1)</sup> AT $I_T$ (V)		TEST CURRENT $I_T$ (mA)	STAND-OFF VOLTAGE $V_{WM}$ (V)	MAXIMUM REVERSE LEAKAGE AT $V_{WM}$ $I_R$ ( $\mu\text{A}$ )	MAXIMUM REVERSE LEAKAGE AT $V_{WM}$ $T_J = 150\text{ }^\circ\text{C}$ $I_D$ ( $\mu\text{A}$ )	MAXIMUM PEAK PULSE SURGE CURRENT $I_{PPM}$ <sup>(2)</sup> (AMPS)	MAXIMUM CLAMPING VOLTAGE AT $I_{PPM}$ $V_C$ (VOLTS)	MAXIMUM TEMPERATURE COEFFICIENT OF $V_{(BR)}$ ( $\%/^\circ\text{C}$ )
		MIN	MAX							
TPSMP6.8	ADP	6.12	7.48	10.0	5.50	300	1000	23.2	10.8	0.057
TPSMP6.8A	AEP	6.45	7.14	10.0	5.80	300	1000	23.8	10.5	0.057
TPSMP7.5	AFP	6.75	8.25	10.0	6.05	150	500	25.6	11.7	0.060
TPSMP7.5A	AGP	7.13	7.88	10.0	6.40	150	500	26.5	11.3	0.061
TPSMP8.2	AHP	7.38	9.02	10.0	6.63	50.0	200	24.0	12.5	0.065
TPSMP8.2A	AKP	7.79	8.61	10.0	7.02	50.0	200	24.8	12.1	0.065
TPSMP9.1	ALP	8.19	10.0	1.0	7.37	10.0	50.0	21.7	13.8	0.068
TPSMP9.1A	AMP	8.65	9.55	1.0	7.78	10.0	50.0	22.4	13.4	0.068
TPSMP10	ANP	9.00	11.0	1.0	8.10	5.0	20.0	20.0	15.0	0.073
TPSMP10A	APP	9.50	10.5	1.0	8.55	5.0	20.0	20.7	14.5	0.073
TPSMP11	AQP	9.90	12.1	1.0	8.92	2.0	10.0	18.5	16.2	0.075
TPSMP11A	ARP	10.5	11.6	1.0	9.40	2.0	10.0	19.2	15.6	0.075
TPSMP12	ASP	10.8	13.2	1.0	9.72	1.0	5.0	17.3	17.3	0.076
TPSMP12A	ATP	11.4	12.6	1.0	10.2	1.0	5.0	18.0	16.7	0.078
TPSMP13	AUP	11.7	14.3	1.0	10.5	1.0	5.0	21.1	19.0	0.081
TPSMP13A	AVP	12.4	13.7	1.0	11.1	1.0	5.0	22.0	18.2	0.081
TPSMP15	AWP	13.5	16.3	1.0	12.1	1.0	5.0	18.2	22.0	0.084
TPSMP15A	AXP	14.3	15.8	1.0	12.8	1.0	5.0	18.9	21.2	0.084
TPSMP16	AYP	14.4	17.6	1.0	12.9	1.0	5.0	17.0	23.5	0.086
TPSMP16A	AZP	15.2	16.8	1.0	13.6	1.0	5.0	17.8	22.5	0.086
TPSMP18	BDP	16.2	19.8	1.0	14.5	1.0	5.0	15.1	26.5	0.088
TPSMP18A	BEP	17.1	18.9	1.0	15.3	1.0	5.0	15.9	25.5	0.088
TPSMP20	BFP	18.0	22.0	1.0	16.2	1.0	5.0	13.7	29.1	0.090
TPSMP20A	BGP	19.0	21.0	1.0	17.1	1.0	5.0	14.4	27.7	0.090
TPSMP22	BHP	19.8	24.2	1.0	17.8	1.0	5.0	12.5	31.9	0.092
TPSMP22A	BKP	20.9	23.1	1.0	18.8	1.0	5.0	13.1	30.6	0.092
TPSMP24	BLP	21.6	26.4	1.0	19.4	1.0	5.0	11.5	34.7	0.094
TPSMP24A	BMP	22.8	25.2	1.0	20.5	1.0	5.0	12.0	33.2	0.094
TPSMP27	BNP	24.3	29.7	1.0	21.8	1.0	5.0	10.2	39.1	0.100
TPSMP27A	BPP	25.7	28.4	1.0	23.1	1.0	5.0	10.7	37.5	0.096
TPSMP30	BQP	27.0	33.0	1.0	24.3	1.0	5.0	9.2	43.5	0.097
TPSMP30A	BRP	28.5	31.5	1.0	25.6	1.0	5.0	9.7	41.4	0.097
TPSMP33	BSP	29.7	36.3	1.0	26.8	1.0	5.0	8.4	47.7	0.098
TPSMP33A	BTP	31.4	34.7	1.0	28.2	1.0	5.0	8.8	45.7	0.098
TPSMP36	BUP	32.4	39.6	1.0	29.1	1.0	5.0	7.7	52.0	0.099
TPSMP36A	BVP	34.2	37.8	1.0	30.8	1.0	5.0	8.0	49.9	0.099
TPSMP39	BWP	35.1	42.9	1.0	31.6	1.0	5.0	7.1	56.4	0.100
TPSMP39A	BXP	37.1	41.0	1.0	33.3	1.0	5.0	7.4	53.9	0.100
TPSMP43	BYP	38.7	47.3	1.0	34.8	1.0	5.0	6.5	61.9	0.101
TPSMP43A	BZP	40.9	45.2	1.0	36.8	1.0	5.0	6.7	59.3	0.101

**Note:**

- (1)  $V_{(BR)}$  measured after  $I_T$  applied for 300  $\mu\text{s}$ ,  $I_T$  = square wave pulse or equivalent
- (2) Surge current waveform per fig. 3 and derated per fig. 2
- (3) All terms and symbols are consistent with ANSI/IEEE C62.35



ORDERING INFORMATION				
PREFERRED P/N	UNIT WEIGHT (g)	PREFERRED PACKAGE CODE	BASE QUANTITY	DELIVERY MODE
TPSMP6.8A-E3/84A	0.024	84A	3000	7" Diameter Plastic Tape & Reel
TPSMP6.8A-E3/85A	0.024	85A	10000	13" Diameter Plastic Tape & Reel

**RATINGS AND CHARACTERISTICS CURVES**

(T<sub>A</sub> = 25 °C unless otherwise specified)

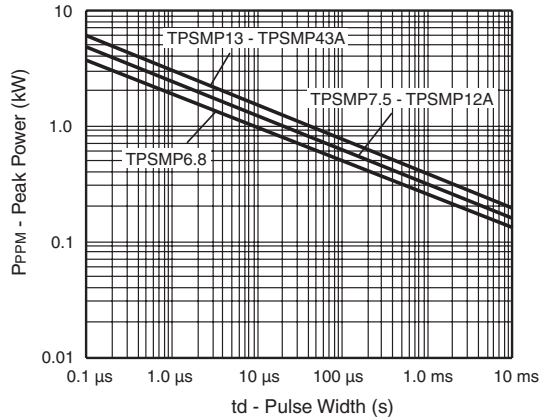

Figure 1. Peak Pulse Power Rating Curve

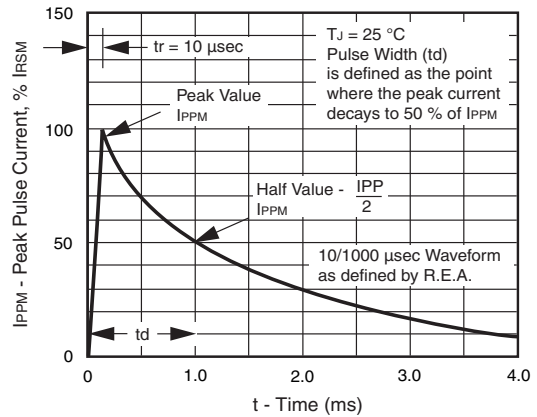

Figure 3. Pulse Waveform

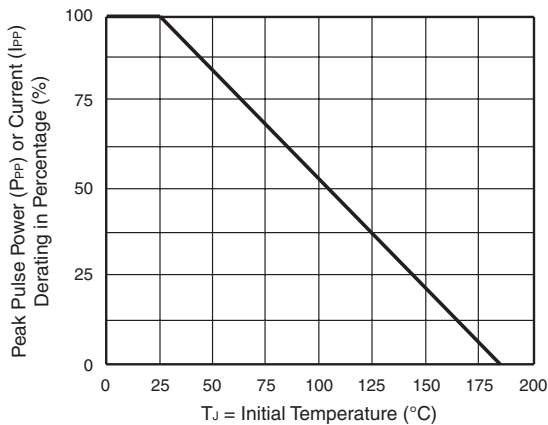

Figure 2. Pulse Derating Curve

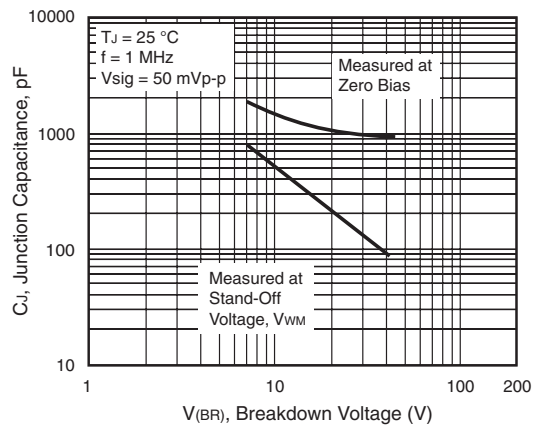

Figure 4. Typical Junction Capacitance

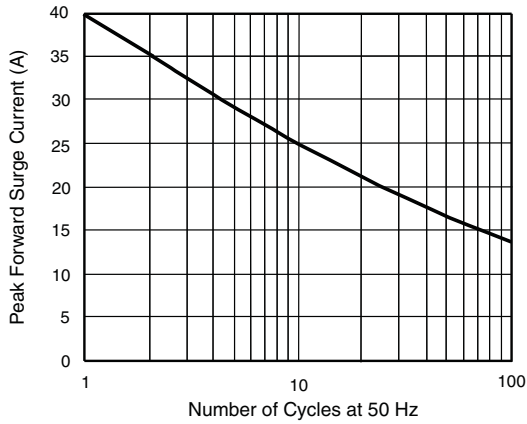

Figure 5. Maximum Peak Forward Surge Current

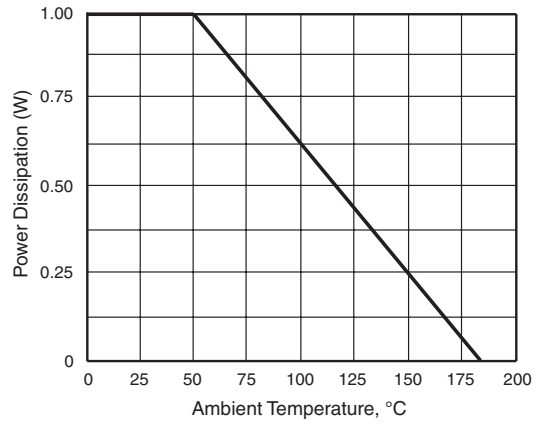
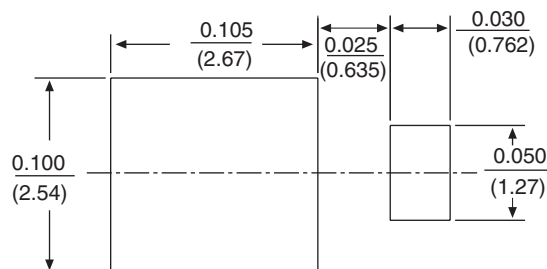
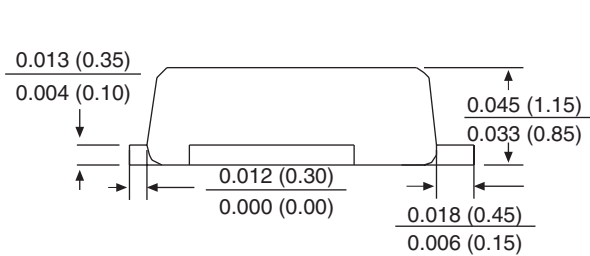
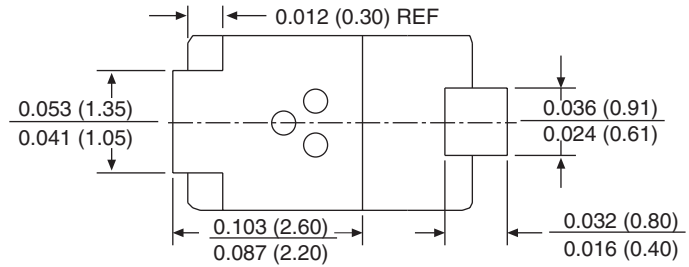
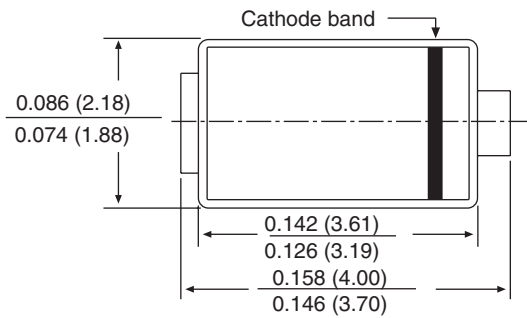

Figure 6. Maximum Peak Forward Surge Current

## PACKAGE OUTLINE DIMENSIONS in inches (millimeters)

### DO-220AA (SMP)





## Notice

Specifications of the products displayed herein are subject to change without notice. Vishay Intertechnology, Inc., or anyone on its behalf, assumes no responsibility or liability for any errors or inaccuracies.

Information contained herein is intended to provide a product description only. No license, express or implied, by estoppel or otherwise, to any intellectual property rights is granted by this document. Except as provided in Vishay's terms and conditions of sale for such products, Vishay assumes no liability whatsoever, and disclaims any express or implied warranty, relating to sale and/or use of Vishay products including liability or warranties relating to fitness for a particular purpose, merchantability, or infringement of any patent, copyright, or other intellectual property right.

The products shown herein are not designed for use in medical, life-saving, or life-sustaining applications. Customers using or selling these products for use in such applications do so at their own risk and agree to fully indemnify Vishay for any damages resulting from such improper use or sale.