



CeraCharge

Rechargeable Multilayer Ceramic Battery

Series/Type: BCT1812M101AG
Ordering code: B73180A0101M062
Date: 2019-06-21
Version: P6

Important Notes

Please observe that CeraCharge™ components must be used only under specified conditions:

- temperature between -20 to +80 °C
- relative humidity ≤ 60%

- Delivered parts are engineering samples, prototypes or pre-series products.
- They are to be used to establish suitability for the intended application. They are not intended for commercial use in series products of the purchaser. TDK Electronics assumes no warranty. Any use is at the sole risk of the purchaser.
- The electrical data or any other feature of these samples may, in terms of the continuing development process, be subject to product and performance improvement. The test results will determine whether the particular development will be completed and incorporated into series production.

Applications

- Internet of things, such as Beacons
- Power backup, such as real time clocks
- Energy storage for energy harvesting devices
- Sub battery for smoothing voltage and current
- Wearable devices

Features

- Rechargeable, long life/cycling time for energy storage and supplying devices
- All-ceramic-structure, eliminating the risks of explosion, burning, and leakage of liquids
- SMT compatible chip, Pb-free reflow solderable
- RoHS compatible
- Li-based ceramic oxide electrolyte / electrode and copper charge collector
- Sputtered Cr/Ni/Ag terminal electrodes

General technical data

Nominal voltage	1.5	V
Typical operating voltage V_{op} ¹⁾	0 ... 1.6	V
Maximum charge voltage ¹⁾	1.8	V
Nominal capacity ²⁾	100	μ Ah
Nominal discharge current	20	μ A
Operating temperature	-20 ... +80	$^{\circ}$ C

1) It is recommended to operate below 1.6 V. In case cycle lifetime degradation is acceptable, it is also possible to charge up to 1.8 V.

2) At ambient condition 25 $^{\circ}$ C and relative humidity less than 60 %

Recommended charge profile

- Constant current charge: setting current in range 10 μ A up to 50 μ A with end voltage 1.6 V.
- Constant voltage charge: setting voltage to 1.6 V with limited current under 200 μ A, end current below 10 μ A.
- Constant current charge / constant voltage charge: For constant current charge set current in range 10 μ A up to 50 μ A with end voltage 1.6 V; for constant voltage charge set voltage to 1.6 V with end current below 10 μ A.

Typical discharge characteristic

($T_A = 25\text{ }^\circ\text{C}$, constant voltage charge with 1.6 V for 3 h)

Constant current discharge with 20 μA (0.2C), 100 μA (1C), 200 μA (2C), 500 μA (5C), 1000 μA (10C) to 0 V

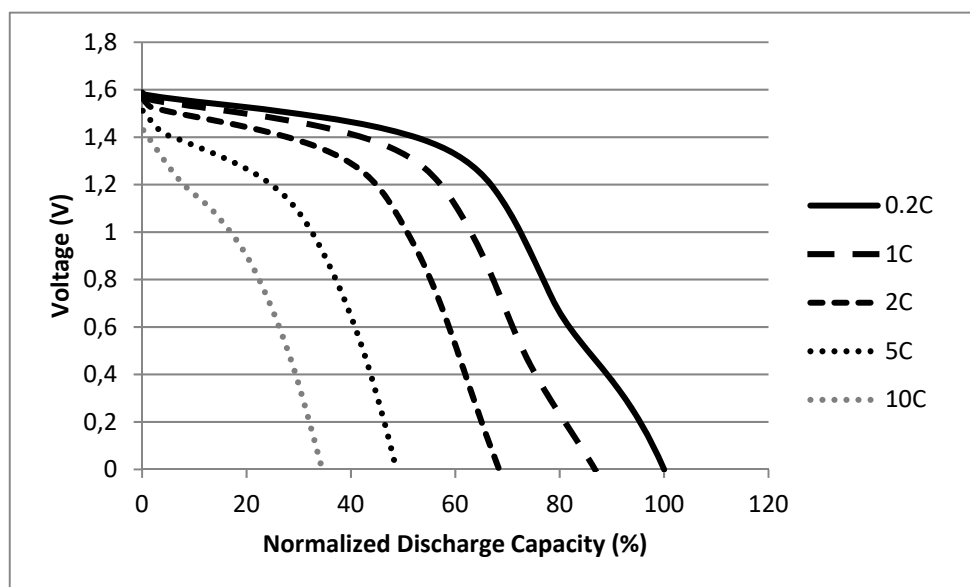

Typical temperature characteristic

($T_A = -20\text{ }^\circ\text{C}$, $0\text{ }^\circ\text{C}$, $25\text{ }^\circ\text{C}$, and $80\text{ }^\circ\text{C}$, constant voltage charge with 1.6 V for 3 h)

Constant current discharge with 20 μA to 0 V

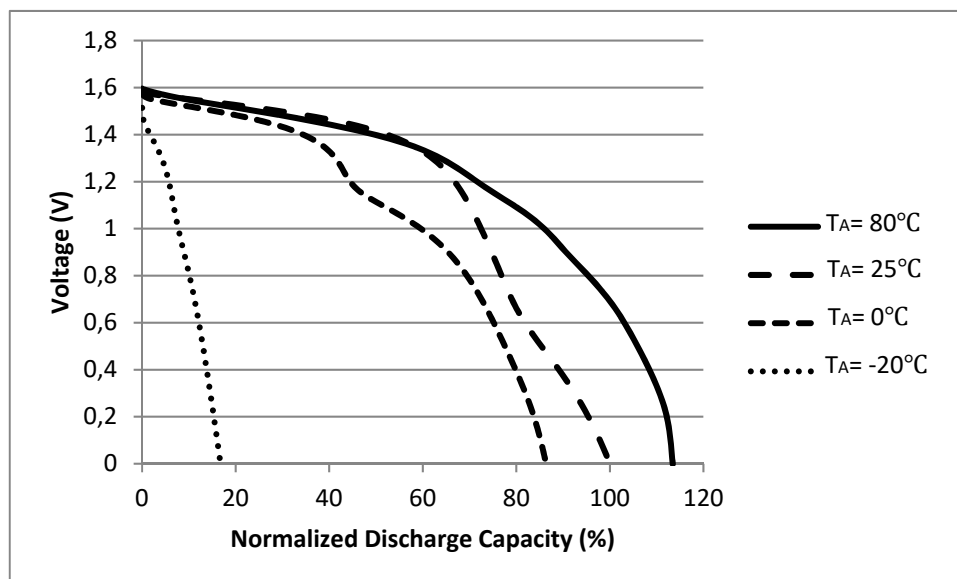

Typical cycle characteristic

(Depth rate 5%, $T_A = 25\text{ }^\circ\text{C}$, relative humidity 20% to 45%)

Charge: constant current with 20 μA to 1.6 V

Discharge: constant current with 20 μA for 15 min

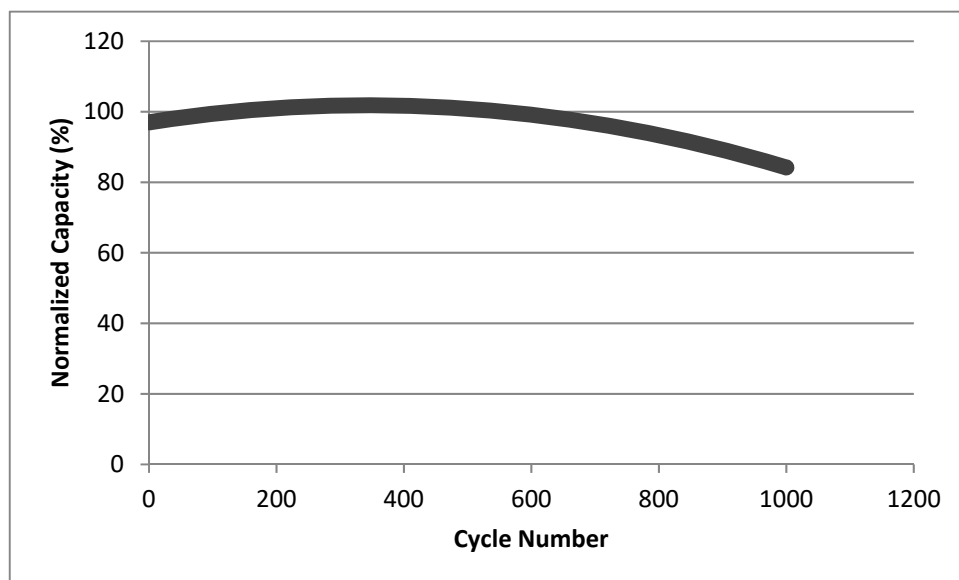

Typical cycle characteristic

(Depth rate 100%, $T_A = 25\text{ }^\circ\text{C}$, relative humidity 30%)

Charge: constant voltage 1.6 V for 3 h

Discharge: constant current with 20 μA until 0 V

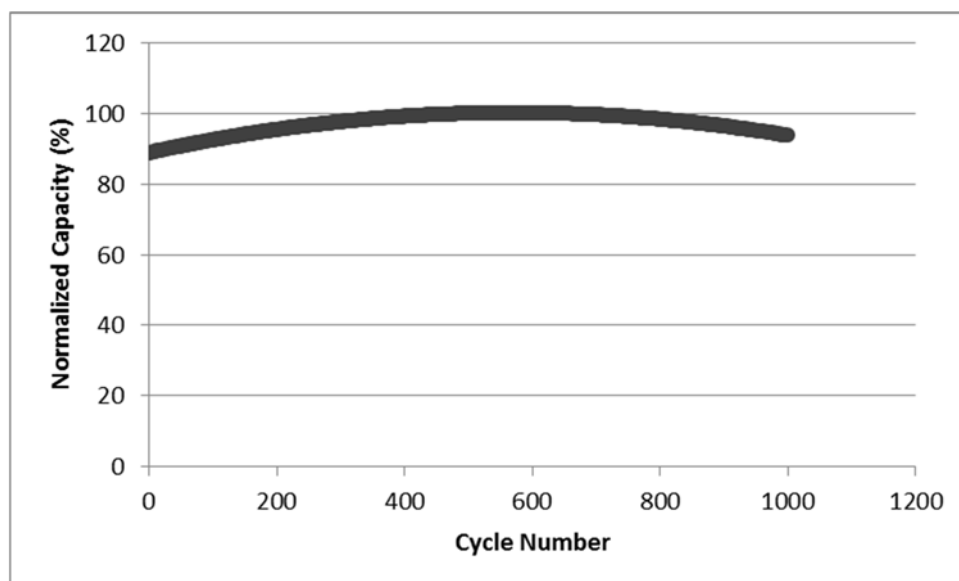

Typical pulse power

($T_A = 25\text{ }^\circ\text{C}$)

Current square pulse length	0.8 ms	1 s	60 s	> 2400 s
Interval	1 s	30 s	none (continuous)	none (continuous)

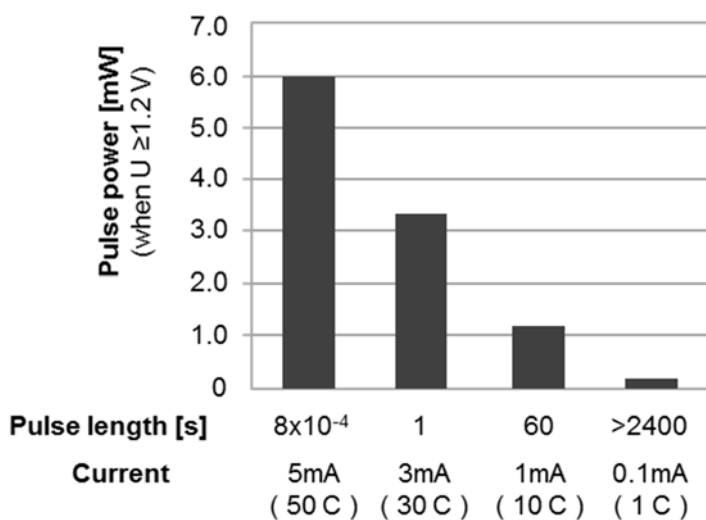

Dimensional drawings

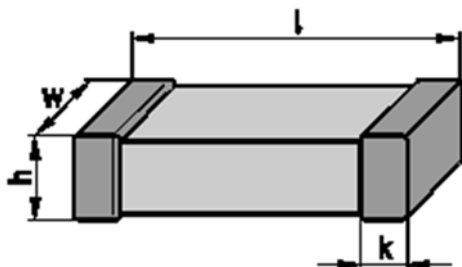

Dimensions in mm (typical values)

Case size	l	W	h	k
1812	4.4±0.2	3.0±0.2	1.1±0.2	Max. 1.0

Materials / dimensions are under development. Changes will be without notification.

Recommended solder pad layout

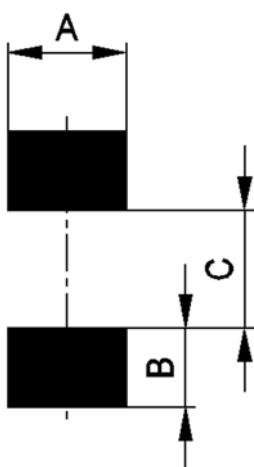

Dimensions in mm

Case size	A	B	C
1812	3.6	1.5	3.0

Recommended reflow soldering profile

Temperature ranges for reflow soldering are according to IEC60068-2-58 recommendations.

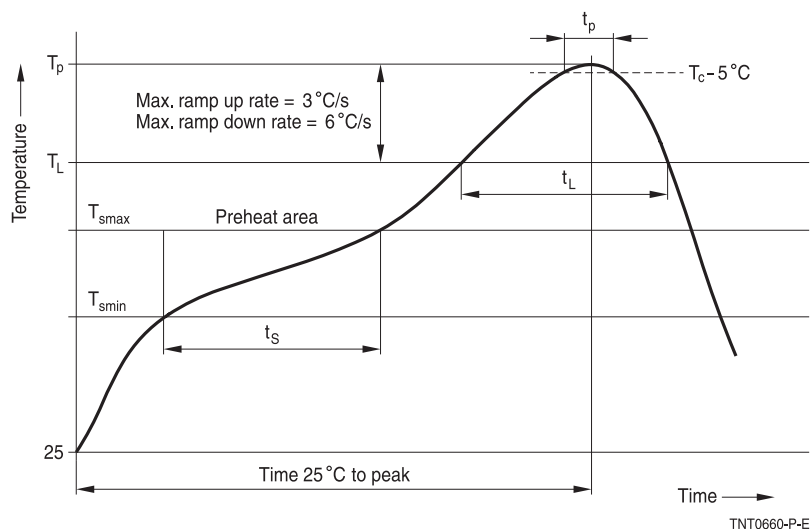

Profile feature		Pb-free assembly
Preheat and soak		
- Temperature min.	T_{smin}	150 °C
- Temperature max.	T_{smax}	200 °C
- Time	t_{smin} to t_{smax}	60 ... 120 s
Average ramp-up rate	T_{smax} to T_p	3 °C/s max.
Liquidous temperature	T_L	217 °C
Time at liquidous	t_L	40 ... 150 s
Peak package body temperature	$T_p^{1)}$	235 ... 260 °C
Time (t_p) above ($T_p - 5$ °C)	t_p	10 ... 40 s
Average ramp-down rate	T_p to T_{smax}	6 °C/s max.
Time 25 °C to peak temperature		max. 8 min

1) Depending on package thickness.

Note: All temperatures refer to topside of the package, measured on the package body surface.

Number of reflow cycles: 1

Iron soldering should be avoided, hot air methods are recommended for repair purposes.

Taping and packaging

Tape and reel packing according to IEC 60286-3.

Tape material: Blister

Dimensions and tolerances

Definition	Symbol	Dimension mm	Tolerance mm
Tape width	W	12.0	±0.3

Package: 12-mm tape

Packing

Packing material: Plastic

Reel dimensions

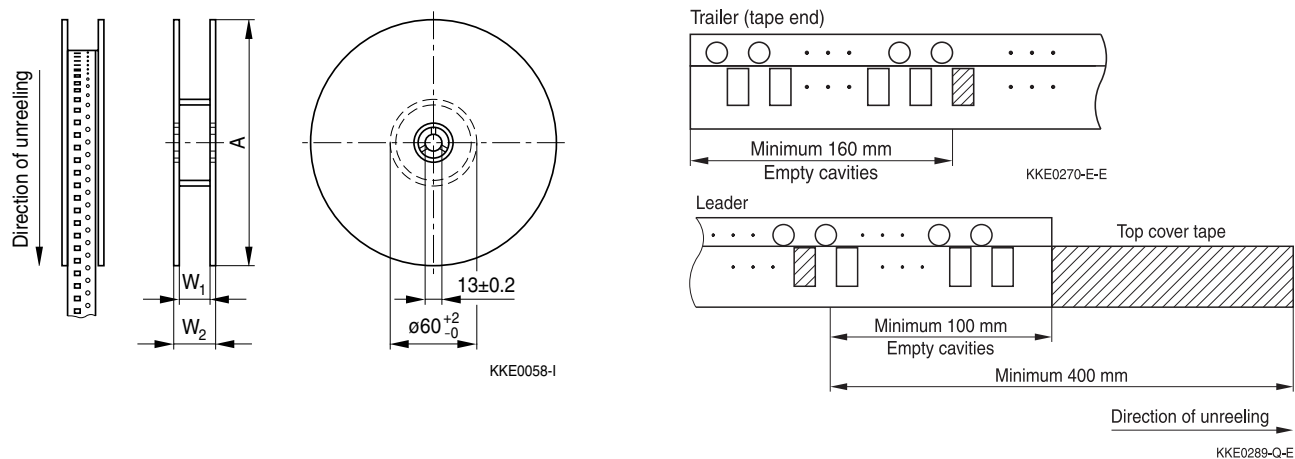

Definition	Symbol	Dimension mm	Tolerance mm
Reel diameter	A	180	+0/-3
Reel width (inside)	W ₁	12.4	+1.5/-0
Reel width (outside)	W ₂	18.4	max.

Symbols and terms

T_A	Ambient temperature
V_{op}	Operating Voltage
SMT	Surface Mount Technology
RoHS	Restriction on Hazardous Substances

Cautions and warnings

Important notes

- CeraCharge will be delivered in uncharged status.
- Do not charge CeraCharge chips before soldering.
- First Charging must be applied after soldering.

General

Some parts of this publication contain statements about the suitability of our CeraCharge components for certain areas of application, including recommendations about incorporation/design-in of these products into customer applications. The statements are based on our knowledge of typical requirements often made of our CeraCharge devices in the particular areas. We nevertheless expressly point out that such statements cannot be regarded as binding statements about the suitability of our CeraCharge components for a particular customer application. As a rule, TDK Electronics is either unfamiliar with individual customer applications or less familiar with them than the customers themselves. For these reasons, it is always incumbent on the customer to check and decide whether the CeraCharge devices with the properties described in the product specification are suitable for use in a particular customer application.

- Do not use CeraCharge components for purposes not identified in our specifications.
- Ensure the suitability of a CeraCharge in particular by testing it for reliability during design-in.
- Always evaluate a CeraCharge component under worst-case application conditions.
- Pay special attention to the reliability of CeraCharge devices intended for use in safety-critical applications (e.g. medical equipment, automotive).
- CeraCharge component is recommended to use below 60% of relative humidity condition.
- Please take care to use each CeraCharge component within the voltage range of the specified value when using multiple in parallel and series.
- Please note that charging the battery leads to a volume change of the active material due to the electrochemical reactions therein. The volume change may lead to a stress relief procedure.
- Polarity will be applied with the first charging.
- Nominal capacity will be observed after a few (typically more than three) cycles of charge and discharge.

Design notes

- In some cases the malfunctioning of electronic components or failure before the end of their service life cannot be completely ruled out in the current state of the art, even if they are operated as specified. In applications requiring a very high level of operational safety and especially when the malfunction or failure of an electronic component could endanger human life or health (e.g. in accident prevention, life-saving systems), ensure by suitable design of the application or other measures that no injury or damage is sustained by third parties in the event of such a malfunction or failure.
- Specified values only apply to CeraCharge components that have not been subject to prior electrical, mechanical or thermal damage.

Storage

- Only store CeraCharge in their original packaging. Do not open the package prior to processing.
- Storage conditions in original packaging: temperature -25 to +45 °C, relative humidity ≤ 75% annual average, dew precipitation is inadmissible.
- Do not store CeraCharge components where they are exposed to heat or direct sunlight. Otherwise the packaging material may be deformed or CeraCharge may stick together, causing problems during mounting.
- Avoid contamination of the CeraCharge surface during storage, handling and processing.
- Avoid storing CeraCharge components in harmful environments where they are exposed to corrosive gases (e.g. Hydrogen Sulphide, Hydrogen Sulphate, Chlorine, Ammonia and Sulfur).
- Use CeraCharge as soon as possible after opening factory seals such as polyvinyl-sealed packages.
- Solder CeraCharge components after shipment from TDK Electronics within 3 months. After opening the package, solder CeraCharge components within 1 week.

Handling

- Do not drop CeraCharge components and allow them to be chipped.
- Do not touch CeraCharge components with your bare hands - gloves are recommended.
- Avoid contamination of the CeraCharge surface during handling.
- Washing processes may damage the product due to the possible static or cyclic mechanical loads (e.g. ultrasonic cleaning). They may cause cracks to develop on the product and its parts, which might lead to reduced reliability or lifetime.

Mounting

- When CeraCharge components are encapsulated with sealing material or overmolded with plastic material, prevent any mechanical clamping of the components.
- Make sure an electrode is not scratched before, during or after the mounting process.
- Make sure contacts and housings used for assembly with CeraCharge components are clean before mounting.
- Avoid contamination of the CeraCharge surface during processing.
- The P.C. board which has CeraCharge components shall not be bended more than 1 mm.

Soldering

- Complete removal of flux is recommended to avoid surface contamination that can result in an instable and/or high leakage current.
- Use resin-type or non-activated flux.
- Bear in mind that insufficient preheating may cause ceramic cracks.
- Rapid cooling by dipping in solvent is not recommended, otherwise a component may crack.

Operation

- Use CeraCharge only within the specified operating temperature range and recommended relative humidity condition.
- Use CeraCharge only within specified voltage and current ranges.
- The CeraCharge has to be operated in a dry atmosphere, which must not contain any additional chemical vapors or substances.
- Environmental conditions must not harm the CeraCharge. Prevent a CeraCharge from contacting liquids and solvents.
- Avoid dewing and condensation.
- CeraCharge components are mainly designed for encased applications. Under all circumstances avoid exposure to:
 - rain or condensation
 - steam, saline spray
 - corrosive gases

This listing does not claim to be complete, but merely reflects the experience of TDK Electronics.

Display of ordering codes for TDK Electronics products

The ordering code for one and the same product can be represented differently in data sheets, data books, other publications, on the company website, or in order-related documents such as shipping notes, order confirmations and product labels. **The varying representations of the ordering codes are due to different processes employed and do not affect the specifications of the respective products.** Detailed information can be found on the Internet under www.tdk-electronics.tdk.com/orderingcodes.

Important notes

The following applies to all products named in this publication:

1. Some parts of this publication contain **statements about the suitability of our products for certain areas of application**. These statements are based on our knowledge of typical requirements that are often placed on our products in the areas of application concerned. We nevertheless expressly point out **that such statements cannot be regarded as binding statements about the suitability of our products for a particular customer application**. As a rule, we are either unfamiliar with individual customer applications or less familiar with them than the customers themselves. For these reasons, it is always ultimately incumbent on the customer to check and decide whether a product with the properties described in the product specification is suitable for use in a particular customer application.
2. We also point out that **in individual cases, a malfunction of electronic components or failure before the end of their usual service life cannot be completely ruled out in the current state of the art, even if they are operated as specified**. In customer applications requiring a very high level of operational safety and especially in customer applications in which the malfunction or failure of an electronic component could endanger human life or health (e.g. in accident prevention or life-saving systems), it must therefore be ensured by means of suitable design of the customer application or other action taken by the customer (e.g. installation of protective circuitry or redundancy) that no injury or damage is sustained by third parties in the event of malfunction or failure of an electronic component.
3. **The warnings, cautions and product-specific notes must be observed.**
4. In order to satisfy certain technical requirements, **some of the products described in this publication may contain substances subject to restrictions in certain jurisdictions (e.g. because they are classed as hazardous)**. Useful information on this will be found in our Material Data Sheets on the Internet (www.tdk-electronics.tdk.com/material). Should you have any more detailed questions, please contact our sales offices.
5. We constantly strive to improve our products. Consequently, **the products described in this publication may change from time to time**. The same is true of the corresponding product specifications. Please check therefore to what extent product descriptions and specifications contained in this publication are still applicable before or when you place an order.

We also **reserve the right to discontinue production and delivery of products**. Consequently, we cannot guarantee that all products named in this publication will always be available. The aforementioned does not apply in the case of individual agreements deviating from the foregoing for customer-specific products.

6. Unless otherwise agreed in individual contracts, **all orders are subject to our General Terms and Conditions of Supply**.
7. **Our manufacturing sites serving the automotive business apply the IATF 16949 standard**. The IATF certifications confirm our compliance with requirements regarding the quality management system in the automotive industry. Referring to customer requirements and customer specific requirements ("CSR") TDK always has and will continue to have the policy of respecting individual agreements. Even if IATF 16949 may appear to support the acceptance of unilateral requirements, we hereby like to emphasize that **only requirements mutually agreed upon can and will be implemented in our Quality Management System**. For clarification purposes we like to point out that obligations from IATF 16949 shall only become legally binding if individually agreed upon.

Important notes

8. The trade names EPCOS, CeraCharge, CeraDiode, CeraLink, CeraPad, CeraPlas, CSMP, CTVS, DeltaCap, DigiSiMic, ExoCore, FilterCap, FormFit, LeaXield, MiniBlue, MiniCell, MKD, MKK, MotorCap, PCC, PhaseCap, PhaseCube, PhaseMod, PhiCap, PowerHap, PQSine, PQvar, SIFERRIT, SIFI, SIKOREL, SilverCap, SIMDAD, SiMic, SIMID, SineFormer, SIOV, ThermoFuse, WindCap are **trademarks registered or pending** in Europe and in other countries. Further information will be found on the Internet at www.tdk-electronics.tdk.com/trademarks.

Release 2018-10