

Main Product Characteristics

$BV_{(BR)DSS}$	-40V
$R_{DS(ON)}$	14mΩ
I_D	-38A

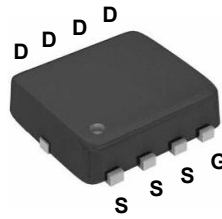

PPAK3x3

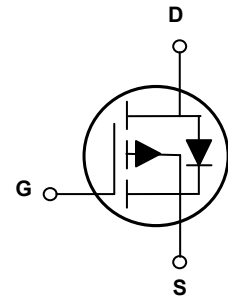

Schematic Diagram

Features and Benefits

- Advanced MOSFET process technology
- Ideal for hand-held devices, battery protection and load switch
- Low on-resistance with low gate charge
- Fast switching and reverse body recovery



Description

The SSFN4903 utilizes the latest techniques to achieve high cell density and low on-resistance. These features make this device extremely efficient and reliable for use in high efficiency switch mode power supply and a wide variety of other applications.

Absolute Maximum Ratings ($T_C=25^{\circ}C$ unless otherwise specified)

Parameter	Symbol	Max.	Unit
Drain-Source Voltage	V_{DS}	-40	V
Gate-Source Voltage	V_{GS}	±20	V
Drain Current-Continuous ($T_C=25^{\circ}C$)	I_D	-38	A
Drain Current-Continuous ($T_C=100^{\circ}C$)		-24	
Drain Current-Pulsed ¹	I_{DM}	-152	A
Single Pulse Avalanche Energy ²	E_{AS}	130	mJ
Single Pulse Avalanche Current ²	I_{AS}	51	A
Power Dissipation ($T_C=25^{\circ}C$)	P_D	52	W
Power Dissipation-Derate above 25°C		0.42	
Thermal Resistance, Junction-to-Ambient	$R_{\theta JA}$	62	°C/W
Thermal Resistance, Junction-to-Case	$R_{\theta JC}$	2.4	°C/W
Operating Junction Temperature Range	T_J	-55 To +150	°C
Storage Temperature Range	T_{STG}	-55 To +150	°C

Electrical Characteristics ($T_J=25^{\circ}\text{C}$ unless otherwise specified)

Parameter	Symbol	Conditions	Min.	Typ.	Max.	Unit
On/Off Characteristics						
Drain-Source Breakdown Voltage	BV_{DSS}	$V_{GS}=0V, I_D=-250\mu A$	-40	-	-	V
Drain-Source Leakage Current	I_{DSS}	$V_{DS}=-40V, V_{GS}=0V, T_J=25^{\circ}\text{C}$	-	-	-1	μA
		$V_{DS}=-32V, V_{GS}=0V, T_J=125^{\circ}\text{C}$	-	-	-10	μA
Gate-Source Leakage Current	I_{GSS}	$V_{GS}=\pm 20V, V_{DS}=0V$	-	-	± 100	nA
Static Drain-Source On-Resistance	$R_{DS(ON)}$	$V_{GS}=-10V, I_D=-15A$	-	11.3	14	m Ω
		$V_{GS}=-4.5V, I_D=-8A$	-	15.6	21	m Ω
Gate Threshold Voltage	$V_{GS(th)}$	$V_{GS}=V_{DS}, I_D=-250\mu A$	-1.0	-1.6	-2.5	V
Forward Transconductance	g_{fs}	$V_{DS}=-10V, I_D=-4A$	-	11	-	S
Dynamic and Switching Characteristics						
Total Gate Charge ^{3,4}	Q_g	$V_{DS}=-32V, I_D=-10A, V_{GS}=-4.5V$	-	22.2	40	nC
Gate-Source Charge ^{3,4}	Q_{gs}		-	8.2	16	
Gate-Drain Charge ^{3,4}	Q_{gd}		-	8.8	16	
Turn-On Delay Time ^{3,4}	$t_{d(on)}$	$V_{DD}=-20V, R_G=6\Omega, V_{GS}=-10V, I_D=-1A$	-	23	40	nS
Rise Time ^{3,4}	t_r		-	10	20	
Turn-Off Delay Time ^{3,4}	$t_{d(off)}$		-	135	250	
Fall Time ^{3,4}	t_f		-	46	90	
Input Capacitance	C_{iss}	$V_{DS}=-25V, V_{GS}=0V, F=1\text{MHz}$	-	2757	4000	pF
Output Capacitance	C_{oss}		-	240	360	
Reverse Transfer Capacitance	C_{rss}		-	137	200	
Drain-Source Diode Characteristics and Maximum Ratings						
Continuous Source Current	I_S	$V_G=V_D=0V,$ Force Current	-	-	-38	A
Pulsed Source Current	I_{SM}		-	-	-76	A
Diode Forward Voltage	V_{SD}	$V_{GS}=0V, I_S=-1A, T_J=25^{\circ}\text{C}$	-	-	-1	V

Note:

1. Repetitive rating: Pulsed width limited by maximum junction temperature.
2. $V_{DD}=25V, V_{GS}=10V, L=0.1\text{mH}, I_{AS}=51A, R_G=25\Omega,$ starting $T_J=25^{\circ}\text{C}$.
3. Pulse test: pulse width $\leq 300\mu s,$ duty cycle $\leq 2\%$.
4. Essentially independent of operating temperature.

Typical Electrical and Thermal Characteristic Curves

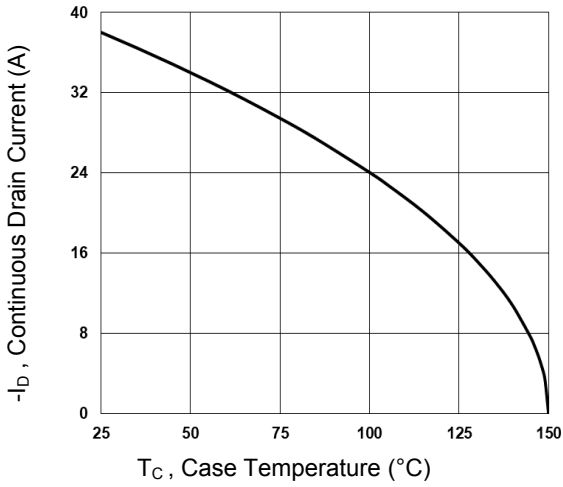

Figure 1. Continuous Drain Current vs. T_C

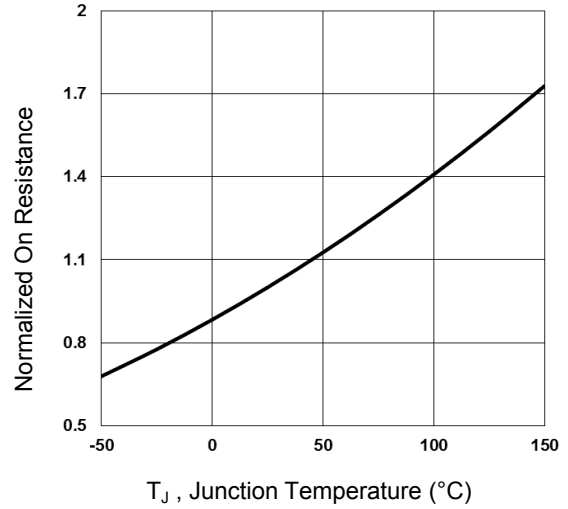

Figure 2. Normalized $R_{DS(ON)}$ vs. T_J

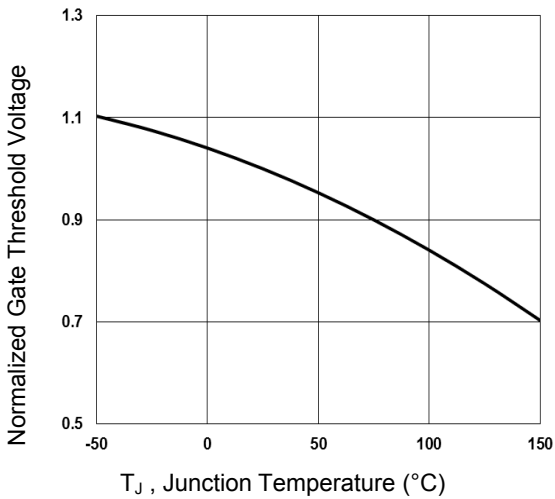

Figure 3. Normalized V_{th} vs. T_J

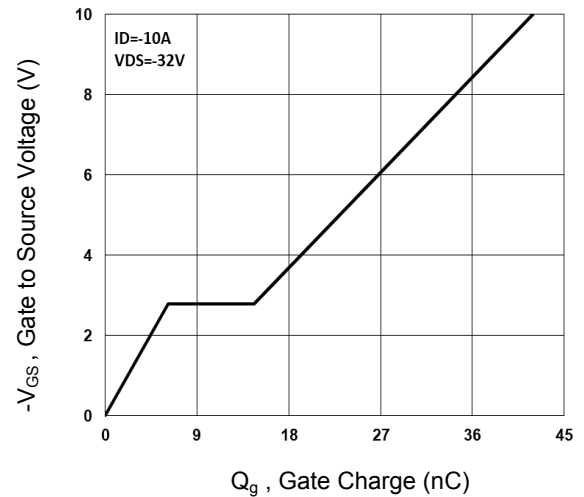

Figure 4. Gate Charge Waveform

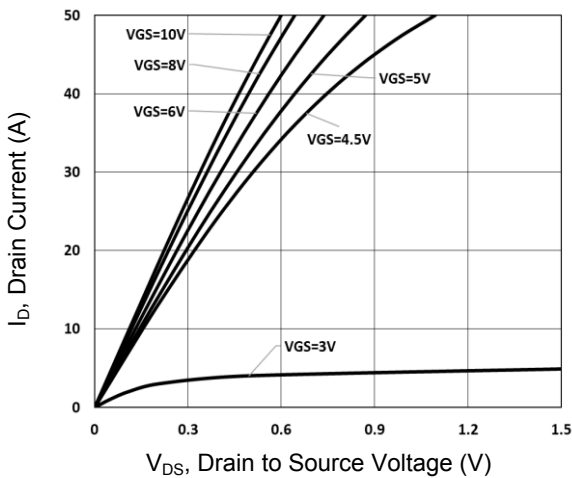

Figure 5. Typical Output Characteristics

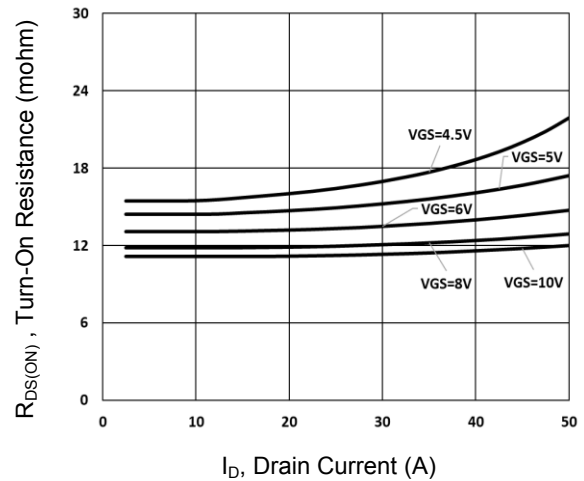

Figure 6. Turn-on Resistance vs. I_D

Typical Electrical and Thermal Characteristic Curves

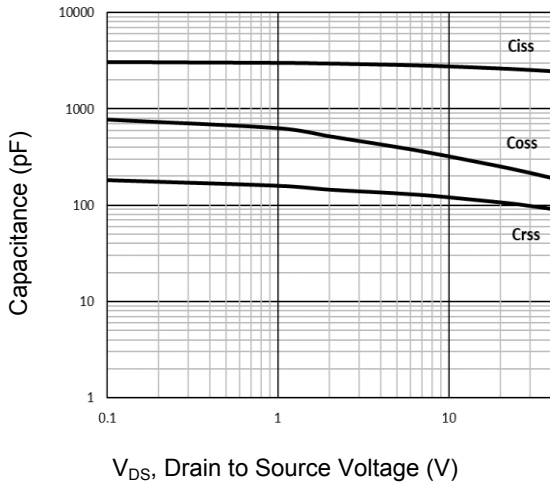

Figure 7. Capacitance Characteristics

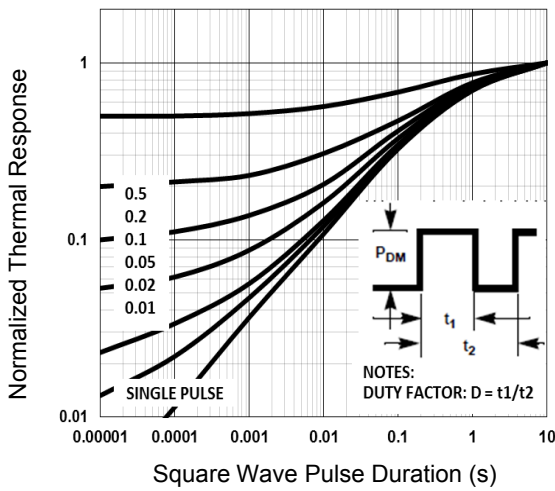

Figure 8. Normalized Transient Impedance

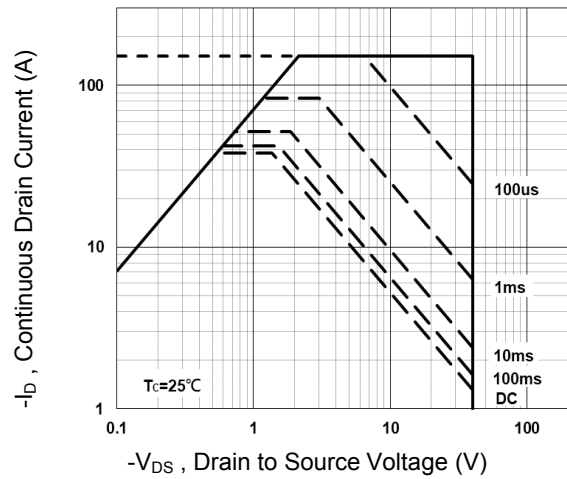

Figure 9. Maximum Safe Operation Area

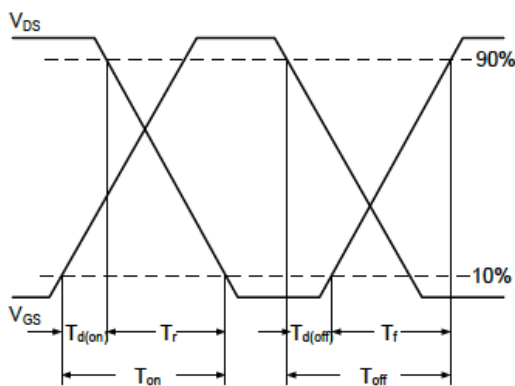

Figure 10. Switching Time Waveform

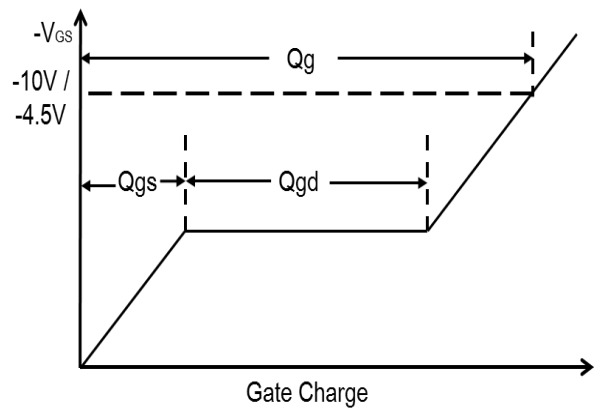
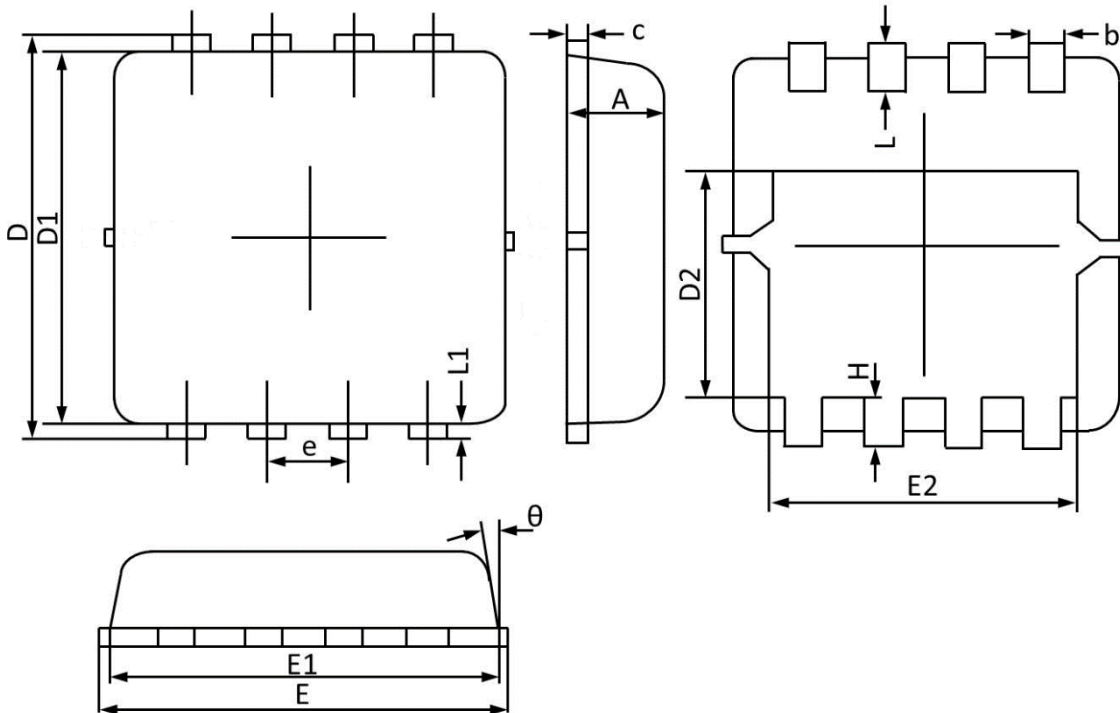

Figure 11. Gate Charge Waveform

Package Outline Dimensions

PPAK3x3



Symbol	Dimensions In Millimeters		Dimensions In Inches	
	MAX	MIN	MAX	MIN
A	0.900	0.700	0.035	0.028
b	0.350	0.250	0.014	0.010
c	0.250	0.100	0.010	0.004
D	3.500	3.050	0.138	0.120
D1	3.200	2.900	0.126	0.114
D2	1.950	1.350	0.077	0.053
E	3.400	3.000	0.134	0.118
E1	3.300	2.900	0.130	0.114
E2	2.600	2.350	0.102	0.093
e	0.65BSC		0.026BSC	
H	0.750	0.300	0.030	0.012
L	0.600	0.300	0.024	0.012
L1	0.200	0.060	0.008	0.002
θ	14°	6°	14°	6°

Recommended Pad Layout

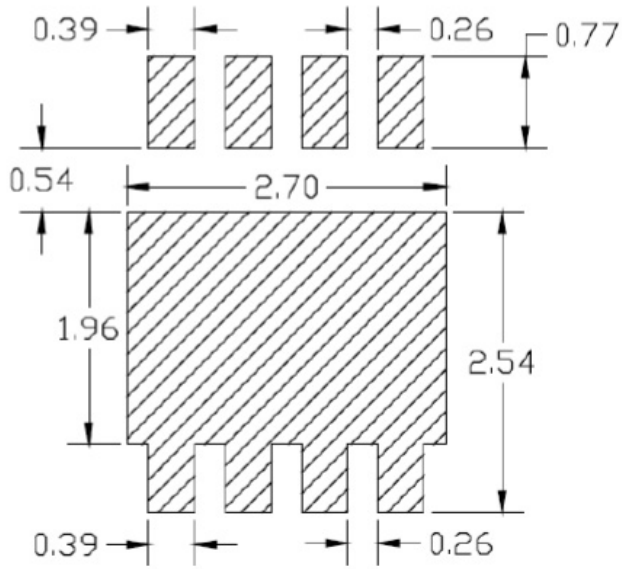

unit : mm