

# PSE Technology Corporation

## SPECIFICATION FOR APPROVAL

CUSTOMER \_\_\_\_\_

NOMINAL FREQUENCY 32.768 KHz



PRODUCT TYPE TYPE KK 3.2x2.5 SEAM SEALED CRYSTAL CLOCK OSCILLATOR

SPEC. NO. ( P/N ) KK3270051

CUSTOMER P/N \_\_\_\_\_

ISSUE DATE May 26, 2011

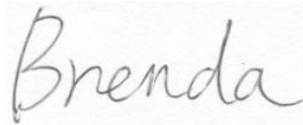
VERSION A

APPROVED	PREPARED	QA
		
<b>APPROVED BY CUSTOMER :</b>		<b>AVL Status</b>
Please return one copy with approval to PSE-TW		

### PSE Technology Corporation

No.2, Tzu-Chiang 5th Rd, Chung Li Industrial Park,  
 Chung Li City, Taoyuan County, Taiwan (R.O.C.)  
 TEL: 886-3-451-8888  
 FAX: 886-3-461-3865  
<http://www.saronix-ecera.com.tw>

- \*Pb-free
- \*RoHS Compliant
- \*HF-Halogen Free
- \*REACH Compliant

\*\*\* A company of  **PERICOM Semiconductor Corporation** \*\*\*



# TYPE KK 3.2x2.5 SEAM SEALED CRYSTAL CLOCK OSCILLATOR

## KK3270051

VER. A    2-Jun-11

### ELECTRICAL SPECIFICATIONS

**SRe Part Number :      KK3270051**

Item	Symbol	Specifications	Units	Notes
Nominal Frequency	F <sub>0</sub>	32.768	KHz	
Frequency Stability	FT	± 25	ppm	**See note
Operating Temperature Range	TR	-40 to +85	°C	
Supply Voltage	V <sub>DD</sub>	+1.8V ± 5%	V	
Logic Type	LT	LVC MOS		
Supply Current, Output Enabled	I <sub>DD/OE</sub>	0.3	mA	Max.
Supply Current, Output Disabled	I <sub>DD/OD</sub>	10	µA	Max.
Duty Cycle (Symmetry)	DC/SY	45 / 55	%	Measured 50% of Waveform
Rise / Fall Time	T <sub>R</sub> /T <sub>F</sub>	15	ns	Measured at 10 / 90% of Waveform
Output Voltage "0" Level	V <sub>OL</sub>	10% V <sub>DD</sub>	V	Max.
Output Voltage "1" Level	V <sub>OH</sub>	90% V <sub>DD</sub>	V	Min.
Output Load	CL	15	pF	Max.
Start Up Time		10	ms	Max.
Storage Temperature Range		-55°C to +125°C	°C	

※ This product doesn't include harmful substance that stipulated by SONY SS-00259 Level 1 and S-AT2-001 Level 1 standard. RoHS Compliant (Pb - Free).

**\*\*Stability includes all combinations of Operating Temperature, Load changes, rated Input (Supply) Voltage changes, Initial Calibration Tolerance (25°C), Aging (1 year at 25°C Average Effective Ambient Temperature), Shock and Vibration.**

#### Output Enable / Disable Function

Parameter	Min.	Typ.	Max.	Units	Notes
Input Voltage (Pin1), Output Enable	0.7V <sub>DD</sub>			V	Or Open
Input Voltage (Pin1), Output Disable (low power standby)			0.3V <sub>DD</sub>	V	Output is Hi-Z
Internal Pullup Resistance		470		KΩ	
Output Disable Delay			100	ns	
Output Enable Delay			10	ms	

# TYPE KK 3.2x2.5 SEAM SEALED CRYSTAL CLOCK OSCILLATOR

## KK3270051

VER. A 2-Jun-11

### TEST CIRCUIT

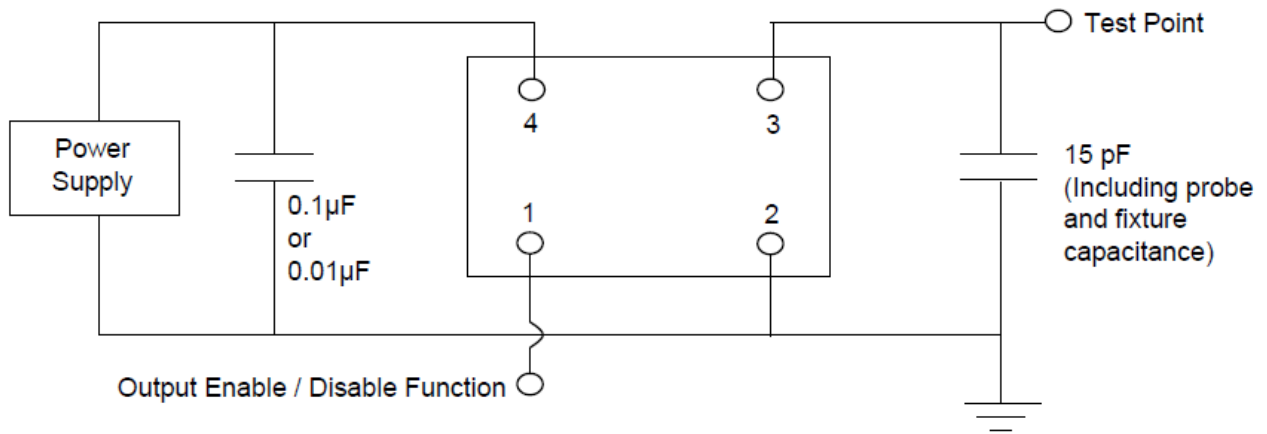

### OUTPUT WAVEFORM

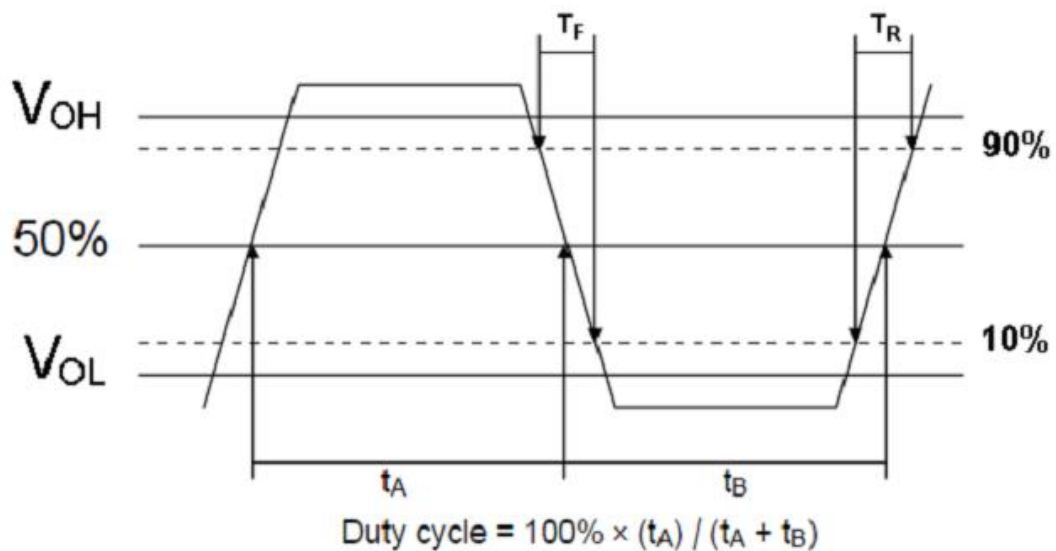

# TYPE KK 3.2x2.5 SEAM SEALED CRYSTAL CLOCK OSCILLATOR

**KK3270051**

VER. A 2-Jun-11

## RELIABILITY SPECIFICATIONS

### ENVIRONMENTAL:

- a) THERMAL SHOCK: MIL-STD-883, Method 1011, Condition A
- b) MOISTURE RESISTANCE: MIL-STD-883, Method 1004
- c) VIBRATION: MIL-STD-883, Method 2007, Condition A
- d) RESISTANCE TO SOLDERING HEAT: J-STD-020D Table 5-2 Pb-free devices (except 2 cycles max)
- e) HAZARDOUS SUBSTANCE: Pb - free and RoHS Compliant.

### MECHANICAL:

- a) SHOCK: MIL-STD-883, Method 2002, Condition B
- b) SOLDERABILITY: JESD22-B102-D Method 2 (Preconditioning E)
- c) TERMINAL STRENGTH: MIL-STD-883, Method 2004, Test Condition D
- d) GROSS LEAK: MIL-STD-883, Method 1014, Condition C
- e) FINE LEAK: MIL-STD-883, Method 1014, Condition A2,  $R1=2 \times 10^{-8}$  atm cc/s
- f) SOLVENT RESISTANCE: MIL-STD-202, Method 215

## SUGGESTED IR REFLOW PROFILE

\*As per IPC-JEDEC J-STD-020D

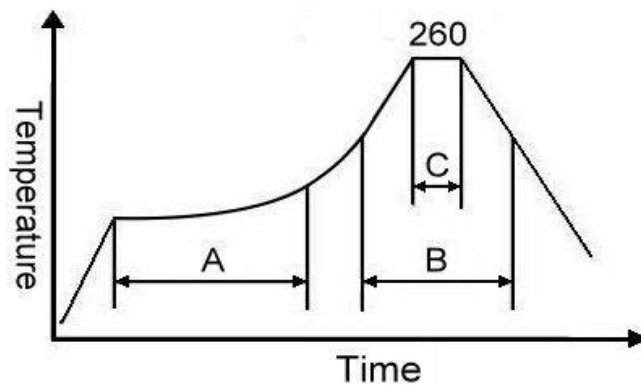

Note:

	Stage	Temperature	Time
A	Preheat	150~200°C	60~120 Sec
B	Primary Heat	217°C	60~150 Sec
C	Peak	260°C	10 Sec

For soldering reflow profile and reliability test ratings go to: <http://www.pericom.com/pdf/sre/reflow.pdf>

# TYPE KK 3.2x2.5 SEAM SEALED CRYSTAL CLOCK OSCILLATOR

## KK3270051

VER. A 2-Jun-11

### MARKING

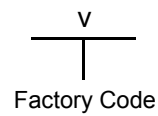
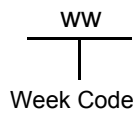
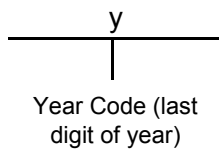

### MECHANICAL DRAWINGS ( Scale:None. Dimensions are in mm.)

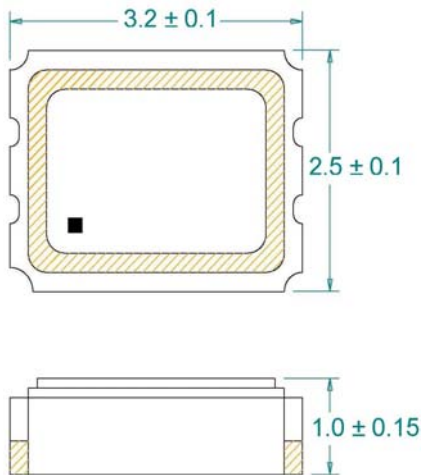

#### Recommended Land Pattern\*

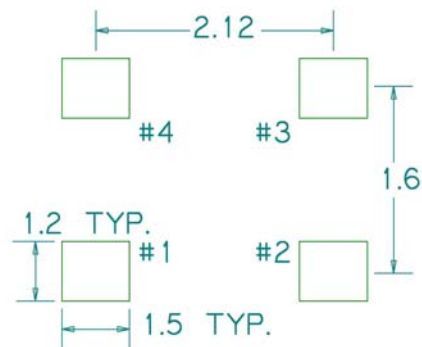

\*External high-frequency power decoupling is recommended.(see test circuit for minimum recommendation). To ensure optimal performance, do not route traces beneath the package.

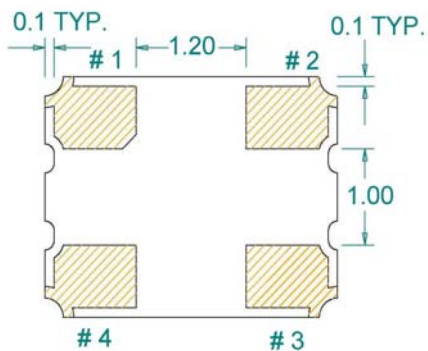

Pin	Function
1	OE
2	Ground
3	Clock Output
4	V <sub>DD</sub>

# TYPE KK 3.2x2.5 SEAM SEALED CRYSTAL CLOCK OSCILLATOR

**KK3270051**

VER. A 2-Jun-11

## TAPE&REEL

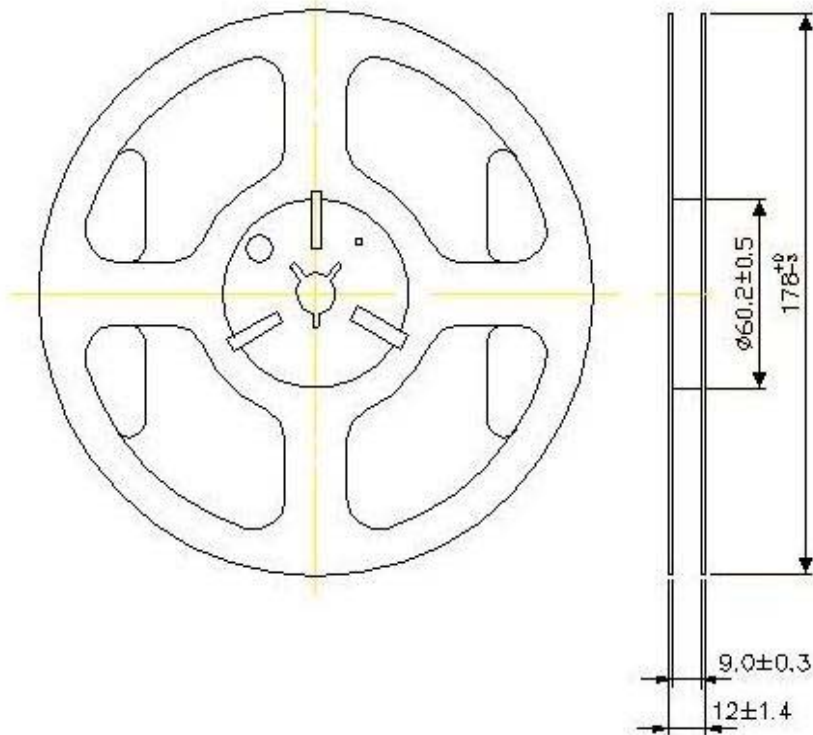
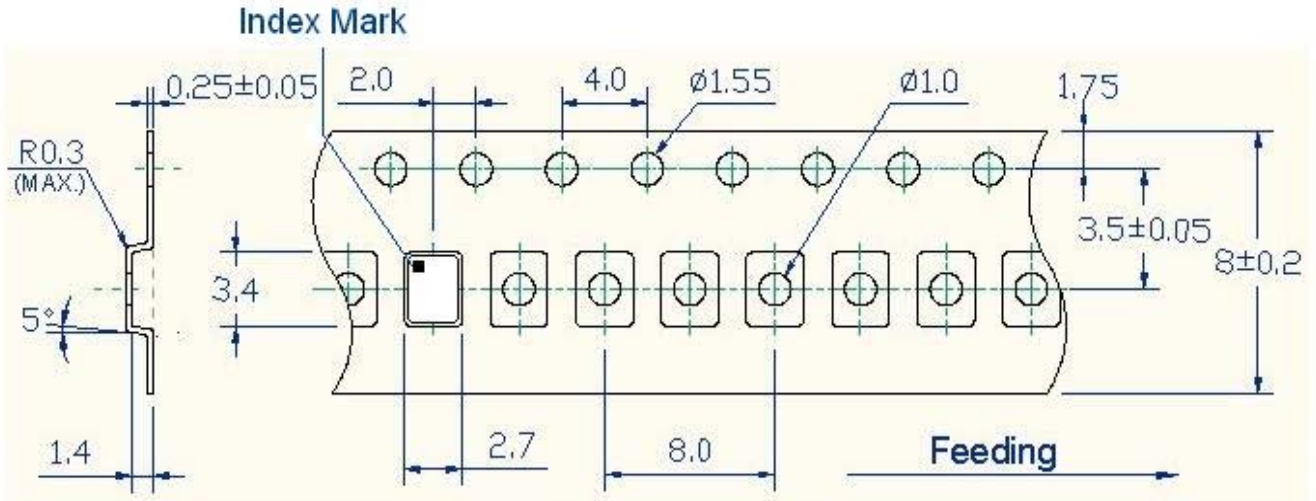

1. 230mm minimum leader which consist of carrier and/or tape followed by a minimum of 160mm of empty carrier tape sealed with cover tape.
2. 160mm minimum trailer of empty carrier tape sealed with cover tape.

# TYPE KK 3.2x2.5 SEAM SEALED CRYSTAL CLOCK OSCILLATOR

## KK3270051

VER. A 2-Jun-11

### PACKING

