



Standard Power Supplies

From The World's No.1 Power Supply Company

October 2018



www.DeltaPSU.com



Table of Contents

■ Company Profile	01	■ Delta Medical Power Supplies	71 - 104
■ Typical Applications	02 - 03	Selection Guide	72 - 75
■ Latest Products	04 - 06	Enclosed Power Supply	76 - 79
■ Delta Industrial Power Supplies	07 - 70	MDS Enclosed Power Supply	77
Selection Guide	8 - 15	MEB Enclosed Power Supply	79
DIN Rail Power Supply	16 - 32	Open Frame Power Supply	80 - 91
CliQ DIN Rail Power Supply	18	MDS Open Frame Power Supply	81
CliQ II DIN Rail Power Supply	20	MEP Open Frame Power Supply	89
CliQ III DIN Rail Power Supply	25	MEU Open Frame Power Supply	90
CliQ M DIN Rail Power Supply	26	ATX Power Supply	92 - 93
CliQ VA DIN Rail Power Supply	27	MDS ATX Power Supply	93
Lyte DIN Rail Power Supply	28	Configurable Power Supply	94 - 95
Chrome DIN Rail Power Supply	29	MEG Configurable Power Supply	95
Sync DIN Rail Power Supply	31	Adapter	96 - 104
Panel Mount Power Supply	33 - 53	MDS Adapter	97
PMT Panel Mount Power Supply	35	MEA Adapter	103
PMT2 Panel Mount Power Supply	40	MEF Adapter	104
PMC Panel Mount Power Supply	41	■ Delta LED Power Supplies	105 - 121
PMH Panel Mount Power Supply	47	Selection Guide	106 - 107
PMF Panel Mount Power Supply	50	LED Driver	108 - 119
PMR Panel Mount Power Supply	51	LNE LED Driver	109
PMU Panel Mount Power Supply	53	LNV LED Driver	119
Open Frame Power Supply	54 - 65	Open Frame Power Supply	120 - 121
PJT Open Frame Power Supply	56	PJL Open Frame Power Supply	121
PJ Open Frame Power Supply	60	■ Accessories	122 - 123
PJB Open Frame Power Supply	63	■ Standards & Approvals	124 - 133
PJH Open Frame Power Supply	64	■ FAQs	134
PJU Open Frame Power Supply	65	■ Notes	135
DIN Rail Modules	66 - 70	■ Augmented Reality (AR)	136
CliQ II Redundancy Modules	67	■ More Information	137
CliQ II Buffer Modules	68		
CliQ II DC-UPS Module	69		
Chrome DC-UPS Module	70		

Company Profile

Delta Electronics Group

World's No.1* Power Supply Company

Delta Electronics Group is the world's largest provider of switching power supplies and a major source for power management and renewable energy solutions. Established in 1971, Delta has sales offices and R&D facilities worldwide with manufacturing plants located in Taiwan, Thailand, China, Mexico, India and Europe.

As a global leader in power electronics, Delta has long been adopting Green manufacturing processes, recycling initiatives, waste management programs and environmentally-friendly green buildings. In 2017, Delta Electronics was selected for the prestigious Dow Jones Sustainability Index (DJSI) World for the seventh consecutive year. Amongst many other national and international awards, since 2010, Delta has also received more than 49 internationally recognized technology and design awards.

1 Standard Industrial and Medical Power Supplies



Delta offers an extensive range of standard power supplies for industrial and medical applications. The industrial power supplies comprise of DIN rail, panel mount and open frame types and LED drivers. The medical power supplies include open frame, enclosed, ATX and AC adapter types. All Delta standard power supplies offer customers the same industrial leading technology and quality that Delta's ODM partners are familiar with. Due to Delta's highly reliable products and world class customer support, we have been expanding our product portfolio aggressively to meet the global demands which have been growing annually. Please visit our standard product homepage at www.DeltaPSU.com for more product information.

2 Modified Standard Power Supplies



Many top tier electronics companies on the Fortune® 500 list have long regarded Delta as a trusted ODM partner. These companies expect nothing less than the best technology and quality. With decades of industrial leading manufacturing and design experiences in ODM power management products, the IPS team can also offer our customers modified standard products by leveraging from the wide range of standard products in our catalog. Modified standard products enable our customers to optimize their costs and product development time. For further query, please contact your local Delta distributor or simply send your query to info@deltapsu.com.

* Based on global sales revenue as reported in Micro-Tech Consultants March 2018 Report.

Typical Applications

Delta Standard Power Supplies



LED Signage/ Display

LED Signage

Applicable Series

PMC, PMT, PMF, PMR



Oil & Gas

Oil & Gas

- Petrol station
- Oil refinery

Applicable Series

CliQ, CliQ II, CliQ M



LED Lighting

LED Lighting

Applicable Series

LNE, LNV, PJJ



Factory

Industry

- Automation process
- Automation engineering

Applicable Series

CliQ, CliQ II, CliQ III, CliQ M, CliQ VA, Lyte, Chrome, MEB, MEP, MEU, PMC, PMT, PMT2, PMF, PMU, Sync



Maritime

Marine

- Offshore

Applicable Series

CliQ M





IT

Smart Building

- Elevator
- Escalator
- Data center
- HVAC

Applicable Series

CliQ, CliQ II, CliQ III, CliQ M, CliQ VA, Chrome, Lyte, Sync



IT

Department Store

- Automatic door
- Vending machine
- ATM

Applicable Series

PMC, PMT, PMH, PMF, PMU, PJ, PJB, PJH, PJJ, PJT, PJJ



Medical

Hospital

Applicable Series

MDS, MEA, MEB, MEF, MEP, MEU



Renewable Energy

Green Energy

- Wind turbine
- Solar farm

Applicable Series

CliQ, CliQ II, CliQ III, CliQ M, CliQ VA, Lyte



Household

Home

- Electrical appliances
- Home automation controller

Applicable Series

CliQ II, CliQ M, Chrome, PJH, PMC, PMH, PMT2, Sync

Latest Products

Delta Standard Power Supplies

Delta Industrial Power Supplies

CliQ III

High Power Density and Competitively Priced



CliQ III

24V
120W-480W

PAGE 25

CliQ VA

Slim Design with Smart Monitoring Function



CliQ VA

24V
120W-480W

PAGE 27

PMT2

Panel Mount with Low Profile Design (30mm)



PMT2

12V, 24V
50W-150W

PAGE 40

PMC

Panel Mount with Power Boost



PMC

12V, 48V
600W

PAGES 43, 46

PJH

Open Frame for Household Application

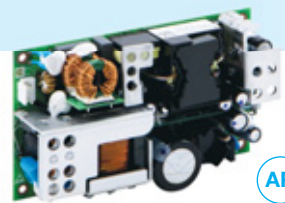

PJH

24V, 36V
300W

PAGE 64

PJU

Open Frame with Integrated DC-UPS



PJU

13V
60W

PAGE 65

Delta Medical Power Supplies

MEB

Intelligent Fan Speed Control



MEB

48V
1,200W

PAGE 79

MEU

PMBus Ver 1.3 Supported



MEU

24V, 48V
600W

PAGE 90

MEP

Open Frame with High MTBF



MEP

15V
25W

PAGE 89

MEG

Compact Size & High Power Density



MEG

Configurable Output
2,100W

PAGE 95

MEA

Desktop Adapter with Efficiency Level VI



MEA

15V 120W
24V 250W

PAGE 103

MEF

Wall Mount Adapter with IP22 Rating



MEF

5V
10W

PAGE 104

Latest Products

Delta Standard Power Supplies

Delta LED Power Supplies

PJL

Open Frame for LED Lighting Power Solution



PJL

48V
200W-400W

PAGE 121

Standard Products

Delta Industrial Power Supplies



Product Types

1 DIN Rail

Delta's feature-rich DIN rail power supplies come with various features such as start up at -40°C , Advanced Power Boost (CliQ M & CliQ VA) and smart monitoring function (CliQ VA) for demanding applications.



3 Open Frame

The Open Frame series offers varieties of nominal output voltage with versatile configuration options, such as enclosed, L frame and open frame (bareboard).



2 Panel Mount

Delta offers many series of panel mount power supplies for different application. For example, the innovative PMC series with corrosion resistant aluminium body. The affordable PMT series with specifications bigger than its price tag. And the PMH series designed for household electrical appliances safety approvals.



4 Modules

The DIN rail modules are useful accessories to enhance your power management solution. The modules include UPS, buffer and redundancy modules are designed to work seamlessly with Delta DIN rail power supplies.



Selection Guide

Delta Industrial Power Supplies

New products are frequently introduced. Please visit www.DeltaPSU.com for latest product updates.

Product Type	Series	Model Name	Phase			PFC	Output Voltage	Output Current	Output Power	Input Voltage Range*	Page			
			1	2	3									
DIN Rail Power Supply	CliQ • Terminal block • Power Boost up to 3s (except DRP-24V48W1AZ)	DRP012V015W1A□	●				12V	1.25A	15W	85-264Vac (DC input range 120-375Vdc)	18			
		DRP012V030W1A□	●					2.5A	30W					
		DRP012V060W1AA	●					5.0A	60W					
		DRP012V100W1AA	●					8.33A	100W					
		DRP-24V48W1AZ	●					24V	2.0A			48W	85-264Vac (DC input range 120-375Vdc)	19
		DRP024V060W1AZ	●					2.5A	60W					
		DRP024V060W1AA	●					2.5A	60W					
		DRP024V120W1AA	●			●		5.0A	120W					
		DRP024V240W1AA	●			●		10.0A	240W					
	DRP024V480W1AA	●			●		20.0A	480W						
	CliQ II • IP20 connector • Power Boost up to 5s	DRP024V060W1B□	●				24V	2.5A	60W	85-264Vac (DC input range 120-375Vdc)	20			
		DRP024V120W1B□	●					5.0A	120W					
		DRP024V240W1B□	●			●		10.0A	240W					
		DRP024V480W1B□	●			●		20.0A	480W					
		DRP024V060W1N□	●					2.5A	60W	85-264Vac (DC input range 120-375Vdc)	21			
		DRP-24V100W1NN	●			●		3.8A	91.2W					
		DRP-24V120W2BN	●	●				5.0A	120W	2 x 180-550Vac or 180-305Vac (Single Phase) (DC input range 254-780Vdc)	22			
		DRP-24V240W2BN	●	●		●		10.0A	240W					
		DRP024V060W3B□		●	●			2.5A	60W	3 x 320-600Vac or 2 x 360-600Vac (DC input range 450-800Vdc)	23			
		DRP024V120W3B□		●	●			5.0A	120W					
		DRP024V240W3B□		●	●			10.0A	240W					
		DRP024V480W3B□		●	●	●		20.0A	480W					
		DRP024V960W3BN		●	●	●		40.0A	960W	For 960W: 3 x 320-600Vac or 2 x 380-600Vac (DC input range 450-800Vdc)				
		DRP048V060W1B□	●					48V	1.25A	60W	85-264Vac (DC input range 120-375Vdc)	24		
	DRP048V120W1B□	●			●		2.5A	120W						
	DRP048V240W1B□	●			●		5.0A	240W						
	DRP048V480W1B□	●			●		10.0A	480W						
	CliQ III • Slim design with high power density • Power Boost up to 5s	DRP-24V120W1CAN	●			●	24V	5.0A	120W	88-264Vac	88-264Vac (DC input range 88-375Vdc)	25		
		DRP-24V120W1CBN	●			●		5.0A	120W					
		DRP-24V240W1CAN	●			●		10.0A	240W					
		DRP-24V240W1CBN	●			●		10.0A	240W					
		DRP-24V480W1CAN	●			●		20.0A	480W					
		DRP-24V480W1CBN	●			●		20.0A	480W					

* DC input is certified for selected models

DIN Rail Power Supply Model Numbering

DR	P	XXXV	XXXW	1	A	□	
DIN Rail	Product Type P - Power Supply	Output Voltage	Output Power	Phase Input 1 - Single Phase	A - CliQ Series	A - Metal Case, with Class I, Div 2 and ATEX approvals Y - Plastic Case, with Class I, Div 2 and ATEX approvals Z - Plastic Case, without Class I, Div 2 and ATEX approvals	
DR	P	XXXV	XXXW	□	□	□	
DIN Rail	Product Type P - Power Supply	Output Voltage	Output Power	Phase Input 1 - Single Phase 2 - Two Phase 3 - Three Phase	B - CliQ II Series N - NEC Class 2	A - Metal Case, with Class I, Div 2 and ATEX approvals N - Metal Case, without Class I, Div 2 and ATEX approvals Y - Plastic Case, with Class I, Div 2 and ATEX approvals Z - Plastic Case, without Class I, Div 2 and ATEX approvals	
DR	P -	XXV	XXXW	1	C	□	N
DIN Rail	Product Type P - Power Supply	Output Voltage	Output Power	Phase Input 1 - Single Phase	C - CliQ III Series	Input Voltage A - AC Input B - AC & DC Input	N - Metal Case, without Class I, Div 2 and ATEX approvals

Product Type	Series	Model Name	Phase	PFC	Output Voltage	Output Current	Output Power	Input Voltage Range*	Page		
			1								
DIN Rail Power Supply	CliQ M <ul style="list-style-type: none"> Slim design with high power density Advanced Power Boost Maritime approvals 	DRM-24V80W1PN	●	●	24V	3.4A	80W	85-276Vac (DC input range 88-375Vdc)	26		
		DRM-24V120W1PN	●	●		5.0A	120W	85-264Vac (DC input range 88-375Vdc)			
		DRM-24V240W1PN	●	●		10.0A	240W	85-276Vac (DC input range 88-375Vdc)			
		DRM-24V480W1PN	●	●		20.0A	480W				
		DRM-24V960W1PN	●	●		40.0A	960W	85-264Vac			
	CliQ VA <ul style="list-style-type: none"> Smart monitoring function Advanced Power Boost 	DRV-24V120W1PN	●	●	24V	5.0A	120W	85-264Vac (DC input range 88-375Vdc)	27		
		DRV-24V240W1PN	●	●		10.0A	240W	85-276Vac (DC input range 88-375Vdc)			
		DRV-24V480W1PN	●	●		20.0A	480W				
	Lyte <ul style="list-style-type: none"> Competitively priced Built-in constant current circuit 	DRL-24V120W1A□	●		24V	5.0A	120W	85-264Vac (DC input range 120-375Vdc)	28		
		DRL-24V240W1A□	●	●		10.0A	240W				
		DRL-24V480W1A□	●	●		20.0A	480W				
		DRL-48V120W1A□	●			48V	2.5A			120W	
	Chrome <ul style="list-style-type: none"> Compact Class II double isolation NEC Class 2 	DRC-5V10W1A□	●		5V	1.5A	7.5W	90-264Vac	29		
		DRC-12V10W1A□	●			12V	0.83A			10W	
		DRC-12V30W1A□	●			2.1A	25.2W				
		DRC-12V60W1A□	●			4.5A	54W				
		DRC-12V100W1AZ	●			6.0A	72W				
		DRC-24V10W1A□	●		24V	0.42A	10W			90-264Vac	30
		DRC-24V10W1HZ	●			0.42A	10W				
		DRC-24V30W1A□	●			1.25A	30W				
	DRC-24V60W1A□	●			2.5A	60W					
	DRC-24V100W1A□	●			3.8A	91.2W	90-264Vac (DC input range 120-375Vdc)				
	Sync <ul style="list-style-type: none"> Compact NEC Class 2 Competitively priced 	DRS-5V30W1NZ	●		5V	3.0A	15W	85-264Vac (DC input range 120-375Vdc)	31		
		DRS-5V50W1A□	●			6.0A	30W				
		DRS-5V50W1N□	●			5.0A	25W				
		DRS-12V50W1N□	●		12V	4.0A	48W			85-264Vac	
		DRS-24V30W1AZ	●			24V	1.25A				30W
		DRS-24V30W1NZ	●		1.25A		30W				
DRS-24V50W1N□		●			2.1A	50W					
DRS-24V100W1A□		●	●		4.0A	96W					
DRS-24V100W1N□	●	●		3.8A	91.2W						

* DC input is certified for selected models

DIN Rail Power Supply Model Numbering

DR	M –	XXV	XXXW	1	P	N
DIN Rail	Product Series M - CliQ M Series	Output Voltage	Output Power	Phase Input 1 - Single Phase	Advanced Power Boost (APB)	N - Metal Case, without Class I, Div 2 and ATEX approvals
DR	V –	XXV	XXXW	1	P	N
DIN Rail	Product Series V - CliQ VA Series	Output Voltage	Output Power	Phase Input 1 - Single Phase	Advanced Power Boost (APB)	N - Metal Case, without Class I, Div 2 and ATEX approvals
DR	L –	XXV	XXXW	1	A	□
DIN Rail	Product Series L - Lyte Series	Output Voltage	Output Power	Phase Input 1 - Single Phase	Standard Bracket	A - Without DC OK Relay Contact S - With DC OK Relay Contact
DR	C –	XXV	XXXW	1	□	□
DIN Rail	Product Type C - Isolation Class II Power Supply	Output Voltage	Output Power	Phase Input 1 - Single Phase	A - No PFC H - Household Approval	Z - Black Plastic Case G - Grey Plastic Case C - Black Plastic Case with conformal coating ¹⁾

1) Options for DRC-24V60W1A□ and DRC-24V100W1A□ only

DR	S –	XXV	XXXW	1	□	□
DIN Rail	Product Series S - Sync Series	Output Voltage	Output Power	Phase Input 1 - Single Phase	A - Non NEC Class 2 N - NEC Class 2	Z - Without DC OK Relay Contact R - With DC OK Relay Contact

Selection Guide

Delta Industrial Power Supplies

New products are frequently introduced. Please visit www.DeltaPSU.com for latest product updates.

Product Type	Series	Model Name	Phase	PFC	Output Voltage	Output Current	Output Power	Input Voltage Range	Page	
			1							
Panel Mount Power Supply	PMT	PMT-4V350W1A□	●		4.2V	60.0A	252W	90-132Vac, 180-264Vac (Selectable by Switch)	35	
		PMT□-5V35W1A□	●		5V	7.0A	35W	85-264Vac		
		PMT□-5V50W1A□	●			10.0A	50W			
		PMT-5V350W1A□	●			60.0A	300W	90-132Vac, 180-264Vac (Selectable by Switch)		
		PMT□-12V35W1A□	●			12V	2.92A	35W	90-264Vac	36
		PMT□-12V50W1A□	●			4.2A	50W			
		PMT□-12V100W1A□	●			8.5A	100W			
		PMT□-12V150W1A□	●			12.5A	150W	90-132Vac, 180-264Vac (Selectable by Switch)		
		PMT-12V350W1A□	●			29.0A	348W			
		PMT□-15V50W1A□	●			15V	3.4A	50W	85-264Vac	37
		PMT□-24V35W1A□	●			24V	1.46A	35W	90-264Vac	
		PMT□-24V50W1A□	●				2.09A	50W		
		PMT□-24V100W1A□	●				4.5A	100W	90-132Vac, 180-264Vac (Selectable by Switch)	
		PMT□-24V150W1A□	●				6.5A	150W		
		PMT□-24V200W1A□	●				8.8A	200W	90-132Vac, 180-264Vac (Selectable by Switch)	38
		PMT-24V350W1AG	●				14.6A	350W		
		PMT-24V350W1AM	●				14.6A	350W		
		PMT-24V350W1AK	●				14.6A	350W		
		PMT-24V350W1AR	●				14.6A	350W		
		PMT-36V350W1A□	●				36V	9.7A	349.2W	90-132Vac, 180-264Vac (Selectable by Switch)
	PMT□-48V150W1A□	●				48V	3.3A	150W		
	PMT-48V350W1A□	●					7.3A	350W		
	PMT□-D1V100W1A□	●				12V/5V	7.0A/3.0A	100W	88-132Vac, 176-264Vac (Selectable by Switch)	
	PMT□-D2V100W1A□	●				24V/5V	3.5A/3.0A	100W		
	PMT2	Universal AC input voltage • Low profile 30mm height	PMT-12V50W2BA	●		12V	4.2A	50W	90-264Vac	40
			PMT-12V100W2BA	●			8.5A	100W		
			PMT-12V150W2BA	●			12.5A	150W	90-132Vac, 170-264Vac (Selectable by Switch)	
			PMT-24V50W2BA	●			24V	2.2A	50W	
PMT-24V100W2BA			●				4.5A	100W		
PMT-24V150W2BA			●				6.25A	150W	90-132Vac, 170-264Vac (Selectable by Switch)	

Panel Mount Power Supply Model Numbering

PM	□ -	XXV	XXXW	1	A	□	□	CC Code ⁶⁾
Panel Mount	Product Type T - Enclosed L - L Frame ¹⁾ B - Open Frame ²⁾	Output Voltage	Output Power	Phase Input Single Phase	No PFC	Connector Type With UL, TUV, CE, CCC A - Terminal Block G - Front Face ³⁾ H - Harness ³⁾ With UL, TUV, CE R - Terminal Block K - Front Face ⁴⁾ With UL M - Terminal Block ⁵⁾ N - Front Face	Blank - Without connector cover A - With connector cover B - With conformal coating C - With conformal coating and connector cover	
Panel Mount	Product Type T - Enclosed L - L Frame ¹⁾	Output Voltage Dual Output D1 - 12V / 5V D2 - 24V / 5V	Output Power	Phase Input Single Phase	No PFC	Connector Type A - Terminal Block G - Front Face ⁷⁾ H - Harness ⁷⁾	Blank - Without connector cover B - With conformal coating	

1) Options for 35W-200W

2) Options for 35W and 50W (except for 5V/35W, 5V/50W and 15V/50W models)

3) Options (Harness connector is not available for 5V/50W model)

4) Options for PMT-24V350W1AK, PMT-36V350W1A□ and PMT-48V350W1A□

5) PMT-24V350W1AG and PMT-24V350W1AM is certified to UL only

6) Options for Terminal Block with Enclosed type only

A - For 4V/350W, 5V/350W, 24V/35W-100W models

B - For 4V/350W, 5V/350W, 12V/35W-150W, 24V/35W-200W models

C - For PMT-4V350W1AM and PMT-5V350W1AM

7) Options for dual output

PM	T -	XXV	XXXW	2	B	A	□	CC Code ¹⁾
Panel Mount	Product Type T - Enclosed	Output Voltage	Output Power	Single Phase with Low Profile	Family Code B - No PFC	Connector Type A - Terminal Block	Blank - Without connector cover A - With connector cover	

1) Options

Product Type	Series	Model Name	Phase	PFC	Output Voltage	Output Current	Output Power	Input Voltage Range*	Page
			1						
Panel Mount Power Supply	PMC • Aluminium casing • Universal AC input voltage	PMC-05V015W1AA	●		5V	3.0A	15W	85-264Vac (DC input range 125-375Vdc)	41
		PMC-05V035W1A□	●			7.0A	35W		
		PMC-05V050W1AA	●			10.0A	50W		
		PMC-12V035W1A□	●		12V	3.0A	35W	85-264Vac (DC input range 125-375Vdc)	42
		PMC-12V050W1A□	●			4.17A	50W		
		PMC-12V060W1NA	●			5.0A	60W		
		PMC-12V100W1A□	●			8.34A	100W		
		PMC-12V150W1B□	●	●		12.5A	150W		
		PMC-12V600W1BA	●	●		50.0A	600W		
		PMC-24V035W1A□	●		24V	1.46A	35W	85-264Vac (DC input range 125-375Vdc)	44
		PMC-24V050W1A□	●			2.1A	50W		
		PMC-24V075W1A□	●			3.12A	75W		
		PMC-24V100W1A□	●			4.17A	100W		
		PMC-24V150W1A□	●			6.25A	150W		
		PMC-24V150W2AA	●			6.25A	150W		
		PMC-24V150W1B□	●	●		6.25A	150W		
		PMC-24V300W1BA	●	●		12.5A	300W		
		PMC-24V600W1BA	●	●		25.0A	600W		
		PMC-DSPV100W1A	●			24V/5V	2.7A/7.0A		
		PMC-48V150W1BA	●	●	48V	3.125A	150W	85-264Vac (DC input range 125-375Vdc)	46
PMC-48V600W1BA	●	●	12.5A	600W					

* DC input is certified for selected models

Panel Mount Power Supply Model Numbering

PM	C -	XXV	XXXW	□	□	□
Panel Mount	Product Type C - Enclosed	Output Voltage	Output Power	Phase Input 1 - Single Phase, Wide Range Input Voltage 2 - Single Phase, High Line Input Voltage	A - No PFC B - With PFC N - NEC Class 2	Connector Type A - Terminal Block ³⁾ J - IP20 Connector ¹⁾ L - Front Face ²⁾ H - Harness ¹⁾
PM	C -	D	SPV	100W	1	A
Panel Mount	Product Type C - Enclosed	Dual Output	Output Voltage S - 24V P - 5V	Output Power	Phase Input Single Phase	Delta Standard

1) Options

2) Options for 150W with PFC

3) For PMC-05V015W1AA and PMC-□V600W1BA, the connector type is a Front Face connector.

For PMC-24V300W1BA, the connector type is an IP20 connector.

Connector Options



Terminal Block connector



IP20 connector



Front Face connector



Harness connector

Selection Guide

Delta Industrial Power Supplies

New products are frequently introduced. Please visit www.DeltaPSU.com for latest product updates.

Product Type	Series	Model Name	Phase	PFC	Output Voltage	Output Current	Output Power	Input Voltage Range*	Page		
			1								
Panel Mount Power Supply	PMH • IEC 60335, IEC 61558 approvals • Withstand line input voltage surge 300Vac up to 7 seconds • Low profile (for selected models)	PMH-24V50WCA□	●		24V	2.1A	50W	85-264Vac (DC input range 120-375Vdc)	47		
		PMH-24V100WCA□	●			4.16A	100W				
		PMH-24V100WCC□	●			4.16A	100W				
				PMH-24V100WCN□	●		24V	3.8A	91.2W	85-264Vac (DC input range 120-375Vdc)	48
				PMH-24V150WCB□	●	●		6.25A	150W		
				PMH-24V150WCD□	●	●		6.25A	150W		
				PMH-24V200WCB□	●	●		8.33A	200W	85-264Vac (DC input range 120-375Vdc)	49
				PMH-12V100WCL□	●		12V	8.5A	100W		
				PMH-24V100WCL□	●		24V	4.5A	100W		
				PMH-24V100WCM□	●			3.8A	91.2W		
			PMH-24V150WCL□	●			6.5A	150W			
		PMF • Remote ON/OFF • Built-in PFC	PMF-4V320WC□□	●	●	4.2V	55.0A	231W	85-264Vac	50	
			PMF-5V320WC□□	●	●	5V	55.0A	275W			
			PMF-24V200WC□□	●	●	24V	8.4A	200W			
			PMF-24V240WC□□	●	●		10.0A	240W			
			PMF-24V320WC□□	●	●		13.3A	320W	88-264Vac	51	
	PMR • Thickness < 1U • Built-in PFC	PMR-4V320WC□A	●	●	4.2V	60.0A	252W				
		PMR-4V320WDAA	●	●		60.0A	252W				
		PMR-4V320WDGA	●	●		60.0A	252W				
		PMR-4V320WDBA	●	●		60.0A	252W				
		PMR-4V320WDCA	●	●		60.0A	252W				
		PMR-5V320WC□A	●	●	5V	60.0A	300W				
		PMR-5V320WDAA	●	●		60.0A	300W				
		PMR-5V320WDGA	●	●		60.0A	300W				
		PMR-5V320WDBA	●	●		60.0A	300W				
		PMR-5V320WDCA	●	●		60.0A	300W				

* DC input is certified for selected models

Panel Mount Power Supply Model Numbering

PM	H –	XXV	XXXW	C	□	□
Panel Mount	Product Series H - Household Series	Output Voltage	Output Power	Package Type C - Enclosed	Pollution Degree 2 A - No PFC B - With PFC Pollution Degree 3 C - No PFC D - With PFC L - Low Profile M - Low Profile with NEC Class 2 N - NEC Class 2	Output Non-Isolated to PE (PELV) A - Terminal Block J - IP20 connector L - Front Face H - Harness Output Isolated to PE (SELV) S - Terminal Block U - IP20 Connector V - Front Face T - Harness

PM	F –	XXV	XXXW	C	□	□
Panel Mount	Product Series F - PFC Series	Output Voltage	Output Power	Package Type C - Enclosed	Connector Type G - Front Face A - Terminal Block ¹⁾	Variable B - No Remote ON/OFF R - With Remote ON/OFF ¹⁾

PM	R –	XXV	XXXW	□	□	□
Panel Mount	Product Series R - Standard Rack Type Series (1U)	Output Voltage	Output Power	Package Type C - Enclosed with Fan D - Enclosed without Fan	Connector Type A - Terminal Block B - Terminal Block (Parallel Operation) ²⁾ G - Front Face ¹⁾ C - Front Face (Parallel Operation) ²⁾	Variable A - With conformal coating

1) Options

2) Options for Enclosed without Fan (PMR-□V320WDBA and PMR-□V320WDCA)

Product Type	Series	Model Name	Phase	PFC	Output Voltage	Output Current	Output Power	Input Voltage Range	Page
			1						
Panel Mount Power Supply	PMU • Power supply with integrated DC-UPS	PMU-13V155W□BA	●		13.8V	V1: 9.5A B+: 1.5A	151W	90-132Vac, 180-264Vac (Selectable by Switch)	53
		PMU-13V155W□CA	●						
		PMU-27V155W□BA	●		27.6V	V1: 4.0A (Enclosed) B+: 1.5A (Enclosed) V1: 4.3A (L Frame) B+: 1.2A (L Frame)	151W		
		PMU-27V155W□CA	●						

Panel Mount Power Supply Model Numbering

PM	U –	XXV	XXXW	□	□	A
Panel Mount	Product Series U - With DC UPS Function	Output Voltage	Output Power	Package Type C - Enclosed L - L Frame ¹⁾	Signal B - Without Signal C - With Signal	Connector Type A - Terminal Block

1) Options

Product Type	Series	Model Name	Phase	PFC	Output Voltage	Output Current	Output Power	Input Voltage Range	Page
			1						
Open Frame Power Supply	PJT • High efficiency • Small footprint	PJT-12V40WBA□	●		12V	3.33A	40W	90-264Vac	56
		PJT-12V65WBA□	●			5.0A	60W		
		PJT-12V100WBA□	●	●		8.33A	100W		
		PJT-12V100WB□	●			6.67A (Convection) 8.33A (Forced Air)	80W (Convection) 100W (Forced Air)		
		PJT-15V40WBA□	●		15V	2.67A	40W	90-264Vac	57
		PJT-15V65WBA□	●			4.2A	65W		
		PJT-15V100WBA□	●	●		6.67A	100W		
		PJT-15V100WB□	●			5.33A (Convection) 6.67A (Forced Air)	80W (Convection) 100W (Forced Air)		
		PJT-18V40WBA□	●		18V	2.22A	40W	90-264Vac	58
		PJT-18V65WBA□	●			3.61A	65W		
		PJT-18V100WBA□	●	●		5.55A	100W		
		PJT-18V100WB□	●			4.44A (Convection) 5.55A (Forced Air)	80W (Convection) 100W (Forced Air)		
		PJT-24V40WBA□	●		24V	1.66A	40W	90-264Vac	59
		PJT-24V65WBA□	●			2.71A	65W		
		PJT-24V100WBA□	●	●		4.17A	100W		
		PJT-24V100WB□	●			3.33A (Convection) 4.17A (Forced Air)	80W (Convection) 100W (Forced Air)		
PJT-27V150WBNA	●	●	V1: 27V V _{SS} : 12V	V1: 5.55A V _{SS} : 0.5A	150W	85-264Vac			

Open Frame Power Supply Model Numbering

PJ	T –	XXV	XXXW	B	□	□
Open Frame	Product Series T - ITE Application Series	Output Voltage	Output Power	Package Type B - Open Frame	A - Family Code B - Family Code N - No Remote ON/OFF	Connector Type A - JST connector B - Molex connector ¹⁾ C - JWT connector ¹⁾

1) Options

Selection Guide

Delta Industrial Power Supplies

New products are frequently introduced. Please visit www.DeltaPSU.com for latest product updates.

Product Type	Series	Model Name	Phase	PFC	Output Voltage	Output Current	Output Power	Input Voltage Range	Page
			1						
Open Frame Power Supply	PJ • Built-in PFC • Versatile configurations • Conformal coating	PJ-12V15W□NA	●		12V	1.3A	15W	85-264Vac	60
		PJ-12V30W□NA	●			2.5A	30W		
		PJ-12V50W□NA	●	●		4.3A	50W		
		PJ-12V100W□□A	●	●		8.5A	100W		
		PJ-12V150W□□A	●	●		12.5A	150W		
		PJ-24V30W□NA	●		24V	1.25A	30W	85-264Vac	61
		PJ-24V50W□NA	●	●		2.1A	50W		
		PJ-24V100W□□A	●	●		4.3A	100W		
		PJ-24V150W□□A	●	●		6.3A	150W		
		PJ-5V15W□NA	●		5V	3.0A	15W	85-264Vac	62
	PJ-48V50W□NA	●	●	48V	1.1A	50W			
	PJB • Power Boost up to 10s • Conformal coating	PJB-24V100W□□A	●	●	24V	4.3A	100W	85-264Vac	63
		PJB-24V150W□□A	●	●		6.3A	150W		
		PJB-24V240W□□A	●	●		10.0A	240W		
	PJH • Household and ITE safety approvals	PJH-24V300WBB□	●	●	V1: 24V V _{SB} : 5V	V1: 12.5A V _{SB} : 1.2A	300W	90-264Vac	64
		PJH-24V300WBC□	●	●	V1: 24V V _{SB} : 12V	V1: 12.5A V _{SB} : 0.5A	300W		
		PJH-36V300WBB□	●	●	V1: 36V V _{SB} : 5V	V1: 8.33A V _{SB} : 1.2A	300W		
		PJH-36V300WBC□	●	●	V1: 36V V _{SB} : 12V	V1: 8.33A V _{SB} : 0.5A	300W		
	PJU • Power supply with integrated DC-UPS • Compact size	PJU-13V60W□A□	●		V1: 13.8V B+: 13.6V	V1: 3.9A B+: 0.4A	60W	90-264Vac	65
		PJU-13V60W□B□	●			V1: 3.9A B+: 0.4A	60W		
PJU-27V60W□A□		●		V1: 27.6V B+: 12.4V	V1: 1.75A B+: 0.4A	60W			
PJU-27V60W□B□		●			V1: 1.75A B+: 0.4A	60W			

Open Frame Power Supply Model Numbering

PJ-		XXV	XXXW	□	□	A
Open Frame		Output Voltage	Output Power	Product Type C - Enclosed L - L Frame ¹⁾ B - Open Frame ¹⁾	Remote ON/OFF Function N - No Remote ON/OFF R - With Remote ON/OFF ²⁾	Delta Standard
PJ	B-	XXV	XXXW	□	□	A
Open Frame	Product Series B - Power Boost Series	Output Voltage	Output Power	Package Type C - Enclosed L - L Frame ¹⁾ B - Open Frame ¹⁾	Remote ON/OFF Function N - No Remote ON/OFF R - With Remote ON/OFF ¹⁾	Delta Standard
PJ	H-	XXV	XXXW	B	□	□
Open Frame	Product Type H - Household Series	Output Voltage	Output Power	Package Type B - Open Frame	Voltage Standby B - 5V ¹⁾ C - 12V	Connector Type A - JST connector B - Molex connector ¹⁾ C - JWT connector ¹⁾
PJ	U-	XXV	XXXW	□	□	□
Open Frame	Product Series U - With DC-UPS Function	Output Voltage	Output Power	Package Type C - Enclosed L - L Frame ¹⁾ B - Open Frame ¹⁾	Signal A - Without Signal ¹⁾ B - With Signal	Connector Type A - Terminal Block B - JST connector ¹⁾ C - Molex connector ¹⁾

1) Options

2) Options for 100W and above

Product Type	Series	Model Name	Output Voltage	Output Current	Input Current	Input Voltage Range	Page
Redundancy Module	CliQ II	DRR-20□	22-60V	20.0A	(1+1 Redundancy) = Nominal 2 × 12.5A (N+1 Redundancy) = Nominal 2 × 10A	22-60Vdc	67
		DRR-40□		40.0A	(1+1 Redundancy) = Nominal 2 × 25A (N+1 Redundancy) = Nominal 2 × 20A		
Buffer Module	CliQ II	DRB-24V020AB□	24V	20.0A	Charging Mode: < 0.6A	22.8-28.8Vdc	68
		DRB-24V040ABN		40.0A	Charging Mode: < 0.6A		
DC-UPS Module	CliQ II	DRU-24V40ABN	24V	40.0A	Charging Mode: 2.0A ± 1.0A	24-28Vdc	69
	Chrome	DRU-24V10ACZ		10.0A	Charging Mode: 0.5A ± 0.1A		

Redundancy Module Model Numbering

DR	R –	XX	□
DIN Rail	Product Type R - Redundancy Module	Output Current 20 - 20A 40 - 40A	A - Metal Case, with Class I, Div 2 N - Metal Case, without Class I, Div 2

DC-UPS Module and Buffer Module Model Numbering

DR	□ –	24V	XXXA	□	□
DIN Rail	Product Type U - DC-UPS Module B - Buffer Module	Output Voltage	Output Current	B - CliQ II Series C - Chrome Series	A - Metal Case, with Class I, Div 2 N - Metal Case, without Class I, Div 2 Z - Plastic Case, without Class I, Div 2

Delta Industrial Power Supplies

DIN Rail Power Supply



AR

CliQ™



- Universal AC input voltage range
- Power will not de-rate for the entire input voltage range
- Power Boost of 150% for 3 seconds (24V/480W: 200% for 2 seconds)
- Full corrosion resistant aluminium casing (except 12V/15W, 12V/30W, 24V/48W and 24V/60W)
- Conformal coating on PCBAs to protect against common dust and chemical pollutants (except DRP-24V48W1AZ and DRP024V060W1AZ)
- Hazardous Locations approval to ATEX and Class I, Div 2 for selected models



AR

CliQ II



- Universal AC input voltage range
- Power will not de-rate for the entire input voltage range
- Power Boost of 150% for 5 seconds (24V/480W: 200% for 2 seconds)
- Full corrosion resistant aluminium casing (except DRP024V060W1N□)
- Extreme low temperature cold start -40°C for selected models
- Conformal coating on PCBAs to protect against common dust and chemical pollutants
- Hazardous Locations approval to ATEX and Class I, Div 2 for selected models



AR

CliQ III



- Universal AC input voltage range
- Built-in constant current circuit for charging application
- Power Boost of 150% for 5 seconds
- SEMI F47 compliance at 120Vac
- Extreme low temperature cold start at -40°C
- Built-in DC OK Contact and LED indicator for DC OK
- Conformal coating on PCBA to protect against common dust and chemical pollutants



AR

CliQ M



- Universal AC input voltage range
- High power density in corrosion resistant aluminium casing
- Power Boost of 150% up to 7 seconds
- Advanced Power Boost (APB)
- DNV GL and ABS approvals for maritime applications
- Built-in DC OK contact and LED indicator for DC OK/ Over Load
- Conformal coating on PCBAs to protect against common dust and chemical pollutants



AR

CliQ VA



- Universal AC input voltage range
- LCD display monitoring the output current / voltage / peak current and temperature
- Life time expectancy alarm signal and monitoring
- Power Boost of 150% up to 7 seconds
- Advanced Power Boost (APB)
- DC OK Contact and LED indicator for DC OK/ Overload
- Conformal coating on PCBAs to protect against common dust and chemical pollutants



AR

LYTE



- Universal AC input voltage range
- High power density
- Built-in constant current circuit for reactive loads
- Built-in DC OK relay contact option available
- Compliance to SEMI F47 @ 200Vac
- 15kV common mode & 8kV differential mode ESD immunity
- Conformal coating on PCBAs to protect against common dust and chemical pollutants



AR

CHROME

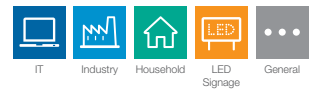

- Class II Double Isolation (No earth connection is required)
- Universal AC input voltage range and full power up to 55°C
- Power will not de-rate for the entire input voltage range
- Can be installed in compact cabinets
- NEC Class 2 and Limited Power Source (LPS) approvals (except DRC-12V100W1AZ)
- Conforms to harmonic current IEC/EN 61000-3-2, Class A
- Safety approval according to IEC/EN/UL 60950-1 (ITE standard) and UL 508 (Industrial standard)



AR

SYNC

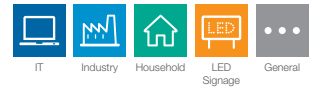

- Ultra compact size
- Universal AC input voltage range and full power from -10°C to 55°C operation
- Up to 89.0% efficiency
- Low earth leakage current < 0.5mA @ 264Vac
- Built-in DC OK relay contact option available
- Extreme low temperature cold start at -40°C
- NEC Class 2 / Limited Power Source (LPS) certified

CliQ DIN Rail Power Supply

12V Output



HIGHLIGHTS & FEATURES

- Universal AC input voltage range
- Power will not de-rate for the entire input voltage range
- Power Boost of 150% for 3 seconds
- Full corrosion resistant aluminium casing for 12V/60W and 12V/100W
- Conforms to harmonic current IEC/EN 61000-3-2, Class A
- Multiple wire connections to terminals allowed
- Conformal coating on PCBAs to protect against common dust and chemical pollutants
- Hazardous Locations approval to ATEX and Class I, Div 2

GENERAL SPECIFICATIONS

OUTPUT	DRP012V015W1A□	DRP012V030W1A□	DRP012V060W1AA	DRP012V100W1AA
Output Voltage	12V	12V	12V	12V
Output Voltage Range	11-14V	11-14V	11-14V	11-14V
Output Current	0-1.25A	0-2.5A	0-5.0A	0-8.33A
Output Power	15W	30W	60W	100W
Line Regulation	< 0.5% typ. (@ 85-264Vac input, 100% load)			
Load Regulation	< 1.0% typ. (@ 85-264Vac input, 0-100% load)			
PARD (20MHz)	< 100mVpp			
Hold-up Time	> 22ms @ 115Vac, > 110ms @ 230Vac			
INPUT				
Phase Input	Single Phase			
Input Voltage Range	85-264Vac (DC input range 120-375Vdc) ¹⁾			
Input Frequency	47-63Hz			
Input Current	< 0.37A @ 115Vac, < 0.22A @ 230Vac	< 0.70A @ 115Vac, < 0.42A @ 230Vac	< 1.35A @ 115Vac, < 0.80A @ 230Vac	< 2.50A @ 115Vac, < 1.50A @ 230Vac
Efficiency ²⁾ at 100% Load	> 84.0% @ 115Vac, > 83.0% @ 230Vac	> 85.0% @ 115Vac & 230Vac	> 86.0% @ 115Vac & 230Vac	> 85.5% @ 115Vac, > 87.5% @ 230Vac
Max Inrush Current (Cold Start)	< 30A @ 115Vac, < 65A @ 230Vac	< 40A @ 115Vac, < 80A @ 230Vac	< 50A @ 115Vac, < 100A @ 230Vac	< 100A @ 115Vac, No Damage @ 230Vac
Power Factor	Conform to EN 61000-3-2			
Leakage Current	< 1mA @ 240Vac			
MECHANICAL				
Case Cover / Chassis	Plastic		Aluminium	
Dimensions (L x W x D)	100 x 32 x 100.6 mm (3.94" x 1.26" x 3.96")	100 x 32 x 100.6 mm (3.94" x 1.26" x 3.96")	121 x 32 x 120 mm (4.76" x 1.26" x 4.72")	121 x 50 x 118.7 mm (4.76" x 1.97" x 4.67")
Unit Weight	0.18 kg (0.40 lb)	0.20 kg (0.44 lb)	0.33 kg (0.73 lb)	0.64 kg (1.41 lb)
Cooling System	Convection			
MTBF ³⁾	> 500,000 hrs	> 500,000 hrs	> 500,000 hrs	> 500,000 hrs
ENVIRONMENT				
Operating Temperature	-20°C to +80°C			
Storage Temperature	-25°C to +85°C			
Power De-rating	> 50°C (2.5% / °C), > 70°C (4% / °C)			
Operating Humidity	5 to 95% RH (Non-Condensing)			
Operating Altitude	0 to 2,000 m (0 to 6,560 ft)			

Dimensions Reference

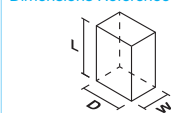

Notes

- 1) All models are certified for DC input.
- 2) At 25°C ambient temperature by vertical mounting orientation.
- 3) MTBF as per Telcordia SR-332 (Confidence level: 90%, I/P: 115Vac, O/P: 100% load) for vertical mounting orientation.
- 4) All parameters are specified at 25°C ambient temperature unless otherwise indicated.

24V Output



AR



HIGHLIGHTS & FEATURES

- Universal AC input voltage range
- Power will not de-rate for the entire input voltage range
- Power Boost of 150% for 3 seconds (480W: 200% for 2 seconds)
- Full corrosion resistant aluminium casing
- SEMI F47 Certified for selected models
- Conforms to harmonic current IEC/EN 61000-3-2, Class A
- Conformal coating on PCBAs to protect against common dust and chemical pollutants (except DRP-24V48W1AZ and DRP024V060W1AZ)
- Hazardous Locations approval to ATEX and Class I, Div 2 (except DRP-24V48W1AZ and DRP024V060W1AZ)

GENERAL SPECIFICATIONS

OUTPUT	DRP-24V48W1AZ	DRP024V060W1AZ	DRP024V060W1AA	DRP024V120W1AA	DRP024V240W1AA	DRP024V480W1AA
Output Voltage	24V	24V	24V	24V	24V	24V
Output Voltage Range	22-26V	22-28V	22-28V	22-28V	22-28V	22-28V
Output Current	0-2.0A	0-2.5A	0-2.5A	0-5.0A	0-10.0A	0-20.0A
Output Power	48W	60W	60W	120W	240W	480W
Line Regulation	< 0.5% typ. (@ 85-264Vac input, 100% load), DRP-24V48W1AZ: < 1% typ.					
Load Regulation	< 1.0% typ. (@ 85-264Vac input, 0-100% load)					
PARD (20MHz)	< 480mVpp	< 240mVpp				
Hold-up Time	> 10ms @ 115Vac, > 60ms @ 230Vac	> 20ms @ 115Vac, > 125ms @ 230Vac		> 35ms @ 115Vac, > 70ms @ 230Vac	> 20ms @ 115Vac & 230Vac	
INPUT						
Phase Input	Single Phase					
Input Voltage Range	85-264Vac (DC input range 120-375Vdc) ¹⁾					
Input Frequency	47-63Hz					
Input Current	< 1.4A @ 115Vac, < 0.7A @ 230Vac	< 1.1A @ 115Vac, < 0.7A @ 230Vac		< 1.4A @ 115Vac, < 0.8A @ 230Vac	< 2.9A @ 115Vac, < 1.5A @ 230Vac	< 5.7A @ 115Vac, < 2.8A @ 230Vac
Efficiency ²⁾ at 100% Load	> 87.0% @ 115Vac & 230Vac	> 86.0% @ 115Vac, > 87.0% @ 230Vac			> 89.0% @ 115Vac, > 91.0% @ 230Vac	> 85.0% @ 115Vac, > 88.0% @ 230Vac
Max Inrush Current (Cold Start)	< 28A @ 115Vac, < 56A @ 230Vac	< 40A @ 115Vac, < 80A @ 230Vac		< 80A @ 115Vac, < 150A @ 230Vac	< 40A @ 115Vac, < 100A @ 230Vac	< 50A @ 115Vac, < 150A @ 230Vac
Power Factor	Conform to EN 61000-3-2			> 0.98 @ 115Vac, > 0.87 @ 230Vac	> 0.96 @ 115Vac, > 0.90 @ 230Vac	> 0.97 @ 115Vac, > 0.95 @ 230Vac
Leakage Current	< 1mA @ 240Vac					< 1.25mA @ 240Vac
MECHANICAL						
Case Cover / Chassis	Plastic			Aluminium		
Dimensions (L x W x D)	100 x 32 x 100.6 mm (3.94" x 1.26" x 3.96")	120.6 x 32 x 113 mm (4.75" x 1.26" x 4.45")	121 x 32 x 120 mm (4.76" x 1.26" x 4.72")	121 x 50 x 118.7 mm (4.76" x 1.97" x 4.67")	121 x 85 x 118.5 mm (4.76" x 3.35" x 4.67")	121 x 160 x 118.5 mm (4.76" x 6.30" x 4.67")
Unit Weight	0.22 kg (0.49 lb)	0.33 kg (0.73 lb)	0.37 kg (0.82 lb)	0.54 kg (1.19 lb)	1.04 kg (2.29 lb)	1.80 kg (3.97 lb)
Cooling System	Convection					
MTBF ³⁾	> 500,000 hrs	> 500,000 hrs	> 500,000 hrs	> 500,000 hrs	> 300,000 hrs	> 300,000 hrs
ENVIRONMENT						
Operating Temperature	-20°C to +70°C		-20°C to +80°C			
Storage Temperature	-25°C to +85°C					
Power De-rating	< -10°C to -20°C (1% / °C), < 0°C to -10°C (2% / °C), > 50°C (2.5% / °C)	< -20°C to -10°C: 80% Load, < 0°C (2% / °C), > 50°C (2.5% / °C)	< 0°C to -20°C (1% / °C), > 50°C (2.5% / °C)	> 50°C (2.5% / °C)		> 50°C (2.5% / °C), > 70°C (4% / °C)
Operating Humidity	5 to 95% RH (Non-Condensing)					
Operating Altitude	0 to 2,000 m (0 to 6,560 ft)					

Dimensions Reference

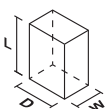

Notes

- 1) All models are certified for DC input except DRP-24V48W1AZ which still fulfills the test conditions of this range. DC input safety approval can be obtained upon request.
- 2) At 25°C ambient temperature by vertical mounting orientation.
- 3) MTBF as per Telcordia SR-332 (Confidence level: 90%, I/P: 115Vac, O/P: 100% load) for vertical mounting orientation.
- 4) All parameters are specified at 25°C ambient temperature unless otherwise indicated.

CliQ II DIN Rail Power Supply

24V Output



HIGHLIGHTS & FEATURES

- Universal AC input voltage range
- Power will not de-rate for the entire input voltage range
- High Efficiency > 90.0% @ 230Vac
- Power Boost of 150% for 5 seconds (480W: 200% for 2 seconds)
- Full corrosion resistant aluminium casing
- Conforms to harmonic current IEC/EN 61000-3-2, Class A
- Extreme low temperature cold start at -40°C
- Conformal coating on PCBAs to protect against common dust and chemical pollutants
- Hazardous Locations approval to ATEX and Class I, Div 2

GENERAL SPECIFICATIONS

OUTPUT	DRP024V060W1B□	DRP024V120W1B□	DRP024V240W1B□	DRP024V480W1B□
Output Voltage	24V	24V	24V	24V
Output Voltage Range	24-28V	24-28V	24-28V	24-28V
Output Current	0-2.5A	0-5.0A	0-10.0A	0-20.0A
Output Power	60W	120W	240W	480W
Line Regulation	< 0.5% typ. (@ 85-264Vac input, 100% load)			
Load Regulation	< 1.0% typ. (@ 85-264Vac input, 0-100% load)			
PARD (20MHz)	< 150mVpp			
Hold-up Time	> 20ms @ 115Vac, > 125ms @ 230Vac	> 20ms @ 115Vac, > 115ms @ 230Vac		> 20ms @ 115Vac & 230Vac
INPUT				
Phase Input	Single Phase			
Input Voltage Range	85-264Vac (DC input range 120-375Vdc) ¹⁾			
Input Frequency	47-63Hz			
Input Current	< 1.4A @ 115Vac, < 0.8A @ 230Vac	< 2.2A @ 115Vac, < 1.1A @ 230Vac	< 2.5A @ 115Vac, < 1.3A @ 230Vac	< 5.0A @ 115Vac, < 3.0A @ 230Vac
Efficiency ²⁾ at 100% Load	> 90.0% @ 115Vac & 230Vac	> 89.0% @ 115Vac, > 90.0% @ 230Vac	> 90.0% @ 115Vac, > 92.0% @ 230Vac	> 91.0% @ 115Vac, > 92.0% @ 230Vac
Max Inrush Current (Cold Start)	< 20A @ 115Vac, < 35A @ 230Vac	< 35A @ 115Vac & 230Vac		
Power Factor	Conform to EN 61000-3-2		> 0.96 @ 115Vac, > 0.90 @ 230Vac	> 0.96 @ 115Vac, > 0.95 @ 230Vac
Leakage Current	< 1mA @ 240Vac			< 3mA @ 240Vac
MECHANICAL				
Case Cover / Chassis	Aluminium			
Dimensions (L x W x D)	121 x 32 x 125 mm (4.76" x 1.26" x 4.92")	121 x 50 x 123.1 mm (4.76" x 1.97" x 4.85")	121 x 85 x 124.1 mm (4.76" x 3.35" x 4.89")	121 x 144 x 118.6 mm (4.76" x 5.67" x 4.67")
Unit Weight	0.37 kg (0.82 lb)	0.72 kg (1.59 lb)	1.10 kg (2.43 lb)	1.37 kg (3.02 lb)
Cooling System	Convection			
MTBF ³⁾	> 800,000 hrs	> 800,000 hrs	> 500,000 hrs	> 500,000 hrs
ENVIRONMENT				
Operating Temperature	-25°C to +80°C			-25°C to +75°C
Storage Temperature	-40°C to +85°C			
Power De-rating	> 50°C (2.5% / °C)			> 50°C (2.5% / °C), > 70°C (5% / °C)
Operating Humidity	5 to 95% RH (Non-Condensing)			
Operating Altitude	0 to 2,500 m (0 to 8,200 ft)			

Dimensions Reference

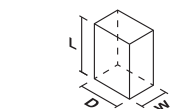

Notes

- 1) All models fulfill the test conditions for this range. DC input safety approval can be obtained upon request. While DRP024V060W1B□ is also certified for DC input.
- 2) At 25°C ambient temperature by vertical mounting orientation.
- 3) MTBF as per Telcordia SR-332 (Confidence level: 90%, I/P: 115Vac, O/P: 100% load) for vertical mounting orientation.
- 4) All parameters are specified at 25°C ambient temperature unless otherwise indicated.

24V Output NEC Class 2



AR



HIGHLIGHTS & FEATURES

- Universal AC input voltage range
- Power will not de-rate for the entire input voltage range
- UL 1310 safety approval
- NEC Class 2 and Limited Power Source (LPS) approvals
- Conforms to harmonic current IEC/EN 61000-3-2, Class A
- Conformal coating on PCBAs to protect against common dust and chemical pollutants
- Hazardous Locations approval to ATEX and Class I, Div 2 (DRP024V060W1NY)

GENERAL SPECIFICATIONS

OUTPUT	DRP024V060W1N□	DRP-24V100W1NN
Output Voltage	24V	24V
Output Voltage Range	24-28V	22-24V
Output Current	0-2.5A	0-3.8A
Output Power	60W	91.2W
Line Regulation	< 0.5% typ. (@ 85-264Vac input, 100% load)	
Load Regulation	< 1.0% typ. (@ 85-264Vac input, 0-100% load); DRP-24V100W1NN: < 1.0% typ. (-25°C to +25°C), < 2.0% typ. (+25°C to +50°C)	
PARD (20MHz)	< 240mVpp	< 150mVpp
Hold-up Time	> 20ms @ 115Vac, > 125ms @ 230Vac	> 20ms @ 115Vac, > 30ms @ 230Vac
INPUT		
Phase Input	Single Phase	
Input Voltage Range	85-264Vac (DC input range 120-375Vdc) ¹⁾	
Input Frequency	47-63Hz	
Input Current	< 1.50A @ 115Vac, < 0.80A @ 230Vac	< 1.00A @ 115Vac, < 0.53A @ 230Vac
Efficiency ²⁾ at 100% Load	> 88.0% @ 115Vac, > 89.0% @ 230Vac	
Max Inrush Current (Cold Start)	< 40A @ 115Vac, < 80A @ 230Vac	< 30A @ 115Vac, < 60A @ 230Vac
Power Factor	Conform to EN 61000-3-2	> 0.99 @ 115Vac, > 0.94 @ 230Vac
Leakage Current	< 0.5mA @ 240Vac	
MECHANICAL		
Case Cover / Chassis	Plastic	Aluminium
Dimensions (L x W x D)	120.6 x 32 x 119.3 mm (4.75" x 1.26" x 4.70")	124 x 40 x 124 mm (4.88" x 1.57" x 4.88")
Unit Weight	0.33 kg (0.73 lb)	0.60 kg (1.32 lb)
Cooling System	Convection	
MTBF ³⁾	> 800,000 hrs	
ENVIRONMENT		
Operating Temperature	-25°C to +80°C	
Storage Temperature	-40°C to +85°C	
Power De-rating	> 50°C (2.5% / °C), > 70°C (4% / °C)	
Operating Humidity	5 to 95% RH (Non-Condensing)	
Operating Altitude	0 to 2,500 m (0 to 8,200 ft)	

Dimensions Reference

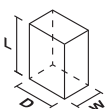

Notes

- 1) All models fulfill the test conditions for DC input. DC input safety approval can be obtained upon request.
- 2) At 25°C ambient temperature by vertical mounting orientation.
- 3) MTBF as per Telcordia SR-332 (Confidence level: 90%, I/P: 115Vac, O/P: 100% load) for vertical mounting orientation.
- 4) All parameters are specified at 25°C ambient temperature unless otherwise indicated.

CliQ II DIN Rail Power Supply

24V Output



HIGHLIGHTS & FEATURES

- Designed for single phase input 180-305Vac (for L-N) or 2 of 3-Phase system 2 x 180-550Vac (for L-L) or 254-780Vdc
- Compact and corrosion resistant aluminium casing
- High Efficiency > 90.0%
- Conforms to harmonic current IEC/EN 61000-3-2, Class A
- Wide operating temperature range from -30°C to +70°C
- Built-in DC OK contact
- Conformal coating on PCBAs to protect against common dust and chemical pollutants

GENERAL SPECIFICATIONS

OUTPUT	DRP-24V120W2BN	DRP-24V240W2BN
Output Voltage	24V	24V
Output Voltage Range	24-28V	24-28V
Output Current	0-5.0A	0-10.0A
Output Power	120W	240W
Line Regulation	< 0.5% typ. (@ 200-550Vac input, 100% load)	
Load Regulation	< 1.0% typ. (@ 200-550Vac input, 0-100% load)	
PARD (20MHz)	< 150mVpp	
Hold-up Time	> 10ms @ 2 x 230Vac, > 50ms @ 2 x 400Vac	> 18ms @ 2 x 230Vac, > 30ms @ 2 x 400Vac
INPUT		
Phase Input	Single Phase or Two Phase	
Input Voltage Range	2 x 180-550Vac or 180-305Vac (Single Phase) (DC input range 254-780Vdc) ¹⁾	
Input Frequency	47-63Hz	
Input Current	< 1.20A @ 2 x 230Vac, < 0.65A @ 2 x 400Vac	< 2.00A @ 2 x 230Vac, < 1.00A @ 2 x 400Vac
Efficiency ²⁾ at 100% Load	> 90.0% @ 2 x 400Vac	
Max Inrush Current (Cold Start)	< 50A @ 2 x 200Vac & 500Vac	
Power Factor	Conform to EN 61000-3-2	> 0.84 @ 2 x 230Vac & 400Vac
Leakage Current	< 3.5mA @ 500Vac	
MECHANICAL		
Case Cover / Chassis	Aluminium	
Dimensions (L x W x D)	124 x 40 x 117 mm (4.88" x 1.57" x 4.61")	124 x 60 x 117 mm (4.88" x 2.36" x 4.61")
Unit Weight	0.62 kg (1.37 lb)	0.81 kg (1.79 lb)
Cooling System	Convection	
MTBF ³⁾	> 800,000 hrs	> 500,000 hrs
ENVIRONMENT		
Operating Temperature	-30°C to +70°C	
Storage Temperature	-40°C to +85°C	
Power De-rating	> 60°C (4% / °C)	> 50°C (2.25% / °C)
Operating Humidity	5 to 95% RH (Non-Condensing)	
Operating Altitude	Industrial Application: 0 to 2,000 m (0 to 6,560 ft); ITE Application: 0 to 2,500 m (0 to 8,200 ft)	

Dimensions Reference

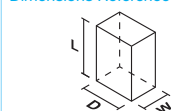

Notes

- 1) All models are certified for DC input.
- 2) At 25°C ambient temperature by vertical mounting orientation.
- 3) MTBF as per Telcordia SR-332 (Confidence level: 90%, I/P: 115Vac, O/P: 100% load) for vertical mounting orientation.
- 4) All parameters are specified at 25°C ambient temperature unless otherwise indicated.

24V Output



HIGHLIGHTS & FEATURES

- Universal AC input voltage range
- Power will not de-rate for the entire input voltage range
- Power Boost of 150% for 5 seconds (480W: 200% for 2 seconds)
- Full corrosion resistant aluminium casing
- Conforms to harmonic current IEC/EN 61000-3-2, Class A
- Extreme low temperature cold start at -40°C
- Conformal coating on PCBAs to protect against common dust and chemical pollutants
- Hazardous Locations approval to ATEX and Class I, Div 2 (except DRP024V960W3BN)

GENERAL SPECIFICATIONS

OUTPUT	DRP024V060W3B□	DRP024V120W3B□	DRP024V240W3B□	DRP024V480W3B□	DRP024V960W3BN
Output Voltage	24V	24V	24V	24V	24V
Output Voltage Range	24-28V	24-28V	24-28V	24-28V	24-28V
Output Current	0-2.5A	0-5.0A	0-10.0A	0-20.0A	0-40.0A
Output Power	60W	120W	240W	480W	960W
Line Regulation	< 0.5% typ. (@ 320-600Vac input, 100% load)				
Load Regulation	< 1.0% typ. (@ 320-600Vac input, 0-100% load)				
PARD (20MHz)	< 150mVpp				< 240mVpp
Hold-up Time	> 20ms @ 3 × 400Vac, > 40ms @ 3 × 500Vac			> 20ms @ 3 × 400Vac & 500Vac	
INPUT					
Phase Input	Two Phase or Three Phase				
Input Voltage Range (Does not exceed 600Vac)	3 × 320-600Vac or 2 × 360-600Vac (DC input range 450-800Vdc) ¹⁾				3 × 320-600Vac or 2 × 380-600Vac (DC input range 450-800Vdc) ¹⁾
Input Frequency	47-63Hz				
Input Current	< 0.30A/Phase @ 400Vac, < 0.25A/Phase @ 500Vac	< 0.50A/Phase @ 400Vac, < 0.40A/Phase @ 500Vac	< 0.75A/Phase @ 400Vac, < 0.65A/Phase @ 500Vac	< 1.00A/Phase @ 400Vac, < 0.75A/Phase @ 500Vac	< 1.70A/Phase @ 400Vac, < 1.40A/Phase @ 500Vac
Efficiency ²⁾ at 100% Load	> 86.0% @ 3 × 400Vac & 500Vac	> 88.0% @ 3 × 400Vac & 500Vac	> 92.0% @ 3 × 400Vac & 500Vac	> 91.0% @ 3 × 400Vac & 500Vac	> 92.0% @ 3 × 400Vac & 500Vac
Max Inrush Current (Cold Start) ³⁾	< 30A @ 3 × 400Vac & 500Vac	< 30A @ 3 × 400Vac & 500Vac	< 40A @ 3 × 400Vac & 500Vac	< 50A @ 3 × 400Vac & 500Vac	< 60A @ 3 × 400Vac & 500Vac
Power Factor	Conform to EN 61000-3-2			> 0.95 @ 3 × 400Vac, > 0.94 @ 3 × 500Vac	
Leakage Current	< 3.5mA @ 500Vac				
MECHANICAL					
Case Cover / Chassis	Aluminium				
Dimensions (L × W × D)	121 × 50 × 117.3 mm (4.76" × 1.97" × 4.62")	121 × 50 × 117.3 mm (4.76" × 1.97" × 4.62")	121 × 70 × 117.3 mm (4.76" × 2.76" × 4.62")	121 × 140 × 117.3 mm (4.76" × 5.51" × 4.62")	121 × 255 × 117.3 mm (4.76" × 10.0" × 4.62")
Unit Weight	0.66 kg (1.46 lb)	0.66 kg (1.46 lb)	0.89 kg (1.96 lb)	1.35 kg (2.98 lb)	2.60 kg (5.73 lb)
Cooling System	Convection				
MTBF ⁴⁾	> 500,000 hrs	> 500,000 hrs	> 500,000 hrs	> 500,000 hrs	> 300,000 hrs
ENVIRONMENT					
Operating Temperature	-25°C to +80°C				-25°C to +65°C
Storage Temperature	-40°C to +85°C				
Power De-rating	> 50°C (2.5% / °C), > 70°C (5% / °C)				> 50°C (2.5% / °C)
Operating Humidity	5 to 95% RH (Non-Condensing)				
Operating Altitude	Industrial Application: 0 to 2,000 m (0 to 6,560 ft); ITE Application: 0 to 2,500 m (0 to 8,200 ft)				

Dimensions Reference

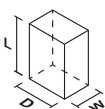

Notes

- 1) All models fulfill the test conditions for this range. DC input safety approval can be obtained upon request. While DRP024V480W3B□ and DRP024V960W3BN are also certified for DC input.
- 2) At 25°C ambient temperature by vertical mounting orientation.
- 3) AC Source capability up to 3kVA.
- 4) MTBF as per Telcordia SR-332 (Confidence level: 90%, I/P: 400Vac, O/P: 100% load) for vertical mounting orientation.
- 5) All parameters are specified at 25°C ambient temperature unless otherwise indicated.

CliQ II DIN Rail Power Supply

48V Output



HIGHLIGHTS & FEATURES

- Universal AC input voltage range
- Power will not de-rate for the entire input voltage range
- High Efficiency > 91.0% @ 230Vac
- Power Boost of 150% for 5 seconds
- Full corrosion resistant aluminium casing
- Conforms to harmonic current IEC/EN 61000-3-2, Class A
- Extreme low temperature cold start at -40°C
- Conformal coating on PCBAs to protect against common dust and chemical pollutants
- Hazardous Locations approval to ATEX and Class I, Div 2

GENERAL SPECIFICATIONS

OUTPUT	DRP048V060W1B□	DRP048V120W1B□	DRP048V240W1B□	DRP048V480W1B□
Output Voltage	48V	48V	48V	48V
Output Voltage Range	48-56V	48-56V	48-56V	48-56V
Output Current	0-1.25A	0-2.5A	0-5.0A	0-10.0A
Output Power	60W	120W	240W	480W
Line Regulation	< 0.5% typ. (@ 85-264Vac input, 100% load)			
Load Regulation	< 1.0% typ. (@ 85-264Vac input, 0-100% load)			
PARD (20MHz)	< 200mVpp			
Hold-up Time	> 20ms @ 115Vac, > 125ms @ 230Vac	> 20ms @ 115Vac, > 50ms @ 230Vac		> 20ms @ 115Vac & 230Vac
INPUT				
Phase Input	Single Phase			
Input Voltage Range	85-264Vac (DC input range 120-375Vdc) ¹⁾			
Input Frequency	47-63Hz			
Input Current	< 1.4A @ 115Vac, < 0.8A @ 230Vac	< 2.2A @ 115Vac, < 1.1A @ 230Vac	< 2.5A @ 115Vac, < 1.3A @ 230Vac	< 5.0A @ 115Vac, < 3.0A @ 230Vac
Efficiency ²⁾ at 100% Load	> 91.0% @ 115Vac, > 92.0% @ 230Vac	> 90.0% @ 115Vac, > 91.0% @ 230Vac	> 90.0% @ 115Vac, > 92.0% @ 230Vac	> 91.0% @ 115Vac, > 93.0% @ 230Vac
Max Inrush Current (Cold Start)	< 20A @ 115Vac, < 35A @ 230Vac	< 35A @ 115Vac & 230Vac		
Power Factor	Conform to EN 61000-3-2	> 0.99 @ 115Vac, > 0.93 @ 230Vac	> 0.96 @ 115Vac, > 0.90 @ 230Vac	
Leakage Current	< 1mA @ 240Vac			< 3mA @ 240Vac
MECHANICAL				
Case Cover / Chassis	Aluminium			
Dimensions (L x W x D)	121 x 32 x 125 mm (4.76" x 1.26" x 4.92")	121 x 50 x 123.1 mm (4.76" x 1.97" x 4.85")	121 x 85 x 124.1 mm (4.76" x 3.35" x 4.86")	121 x 144 x 118.6 mm (4.76" x 5.67" x 4.67")
Unit Weight	0.38 kg (0.84 lb)	0.72 kg (1.59 lb)	0.96 kg (2.12 lb)	1.37 kg (3.02 lb)
Cooling System	Convection			
MTBF ³⁾	> 800,000 hrs	> 800,000 hrs	> 500,000 hrs	> 500,000 hrs
ENVIRONMENT				
Operating Temperature	-25°C to +80°C			-25°C to +75°C
Storage Temperature	-40°C to +85°C			
Power De-rating	> 50°C (2.5% / °C)			> 50°C (2.5% / °C), > 70°C (5% / °C)
Operating Humidity	5 to 95% RH (Non-Condensing)			
Operating Altitude	0 to 2,500 m (0 to 8,200 ft)			

Dimensions Reference

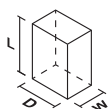

Notes

- 1) All models fulfill the test conditions for DC input. DC input safety approval can be obtained upon request.
- 2) At 25°C ambient temperature by vertical mounting orientation.
- 3) MTBF as per Telcordia SR-332 (Confidence level: 90%, I/P: 115Vac, O/P: 100% load) for vertical mounting orientation.
- 4) All parameters are specified at 25°C ambient temperature unless otherwise indicated.

CliQ III DIN Rail Power Supply

24V Output



HIGHLIGHTS & FEATURES

- Universal AC input voltage range
- Built-in constant current circuit for charging application
- High efficiency of up to 94% at 230Vac
- Power Boost of 150% for 5 seconds
- SEMI F47 compliance at 120Vac
- Extreme low temperature cold start at -40°C
- Built-in DC OK Contact and LED indicator for DC OK
- Conformal coating on PCBA to protect against common dust and chemical pollutants

GENERAL SPECIFICATIONS

	NEW	NEW	NEW
OUTPUT	DRP-24V120W1C□N	DRP-24V240W1C□N	DRP-24V480W1C□N
Output Voltage	24V	24V	24V
Output Voltage Range	24-28V	24-28V	24-28V
Output Current	0-5.0A	0-10.0A	0-20.0A
Output Power	120W	240W	480W
Line Regulation	< 0.5% (@ 88-264Vac input, 100% load)		
Load Regulation	< 1.0% (@ 88-264Vac input, 0-100% load)		
PARD (20MHz)	< 100mVpp		
Hold-up Time	> 20ms @115Vac & 230Vac		> 16ms @115Vac & 230Vac
INPUT			
Phase Input	Single Phase		
Input Voltage Range	DRP-24V□W1CAN: 88-264Vac DRP-24V□W1CBN: 88-264Vac (DC input range 88-375Vdc) ¹⁾		
Input Frequency	47-63Hz		
Input Current	< 1.4A @ 115Vac, < 0.7A @ 230Vac	< 2.6A @ 115Vac, < 1.3A @ 230Vac	< 5.0A @ 115Vac, < 2.5A @ 230Vac
Efficiency ²⁾ at 100% Load	> 89.9% @115Vac, > 91.4% @ 230Vac	> 92.7% @115Vac, > 94.4% @ 230Vac	> 92.5% @115Vac, > 94.0% @ 230Vac
Max Inrush Current (Cold Start)	< 35A @ 115Vac, < 75A @ 230Vac	< 33A @ 115Vac, < 65A @ 230Vac	< 40A @ 115Vac, < 80A @ 230Vac
Power Factor	> 0.96 @ 115Vac, > 0.93 @ 230Vac	> 0.99 @ 115Vac, > 0.93 @ 230Vac	> 0.99 @ 115Vac, > 0.95 @ 230Vac
Leakage Current	< 1.2mA @240Vac		
MECHANICAL			
Case Cover / Chassis	Aluminium		
Dimensions (L x W x D)	124 x 40 x 117 mm (4.88" x 1.57" x 4.60")	124 x 60 x 117 mm (4.88" x 2.36" x 4.60")	124 x 82 x 127 mm (4.88" x 3.23" x 5.00")
Unit Weight	0.58 kg (1.28 lb)	0.84 kg (1.85 lb)	1.20 kg (2.65 lb)
Cooling System	Convection		
MTBF ³⁾	> 1,411,300 hrs	> 1,366,200 hrs	> 1,041,600 hrs
ENVIRONMENT			
Operating Temperature	-25°C to +70°C		
Storage Temperature	-40°C to +85°C		
Power De-rating	> 60°C (2.5% / °C)		AC input: > 60°C (2.5% / °C), DC input: > 50°C (2.5% / °C)
Operating Humidity	5 to 95% RH (Non-Condensing)		
Operating Altitude	0 to 5,000 m (0 to 16,400 ft)		

Dimensions Reference

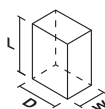

Notes

- 1) All models are certified for DC input.
- 2) At 25°C ambient temperature by vertical mounting orientation.
- 3) MTBF as per Telcordia SR-332 (Confidence level: 90%, I/P: 115Vac, O/P: 100% load) for vertical mounting orientation.
- 4) All parameters are specified at 25°C ambient temperature unless otherwise indicated.

CliQ M DIN Rail Power Supply

24V Output



HIGHLIGHTS & FEATURES

- Universal AC input voltage range
- High power density in corrosion resistant aluminium casing
- Power Boost of 150% up to 7 seconds
- Advanced Power Boost (APB)
- DNV GL and ABS approvals for maritime applications
- Extreme low temperature cold start at -40°C
- Built-in DC OK contact and LED indicator for DC OK/ Over Load
- Conformal coating on PCBAs to protect against common dust and chemical pollutants

GENERAL SPECIFICATIONS

OUTPUT	DRM-24V80W1PN	DRM-24V120W1PN	DRM-24V240W1PN	DRM-24V480W1PN	DRM-24V960W1PN
Output Voltage	24V	24V	24V	24V	24V
Output Voltage Range	24-28V	24-28V	24-28V	24-28V	24-28V
Output Current	3.4-3.0A	5.0-4.5A	10.0-9.0A	20.0-17.0A	40.0-34.3A
Output Power	81.6W	120W	240W	480W	960W
Line Regulation	10mV (@ 85-264Vac input, 100% load)	20mV (@ 85-264Vac input, 100% load)	10mV (@ 85-276Vac input, 100% load)		10mV (@ 85-300Vac input, 100% load)
Load Regulation	100mV (@ 85-276Vac input, 0-100% load); <u>120W</u> : 100mV (@ 85-264Vac input, 0-100% load); <u>960W</u> : 50mV (@ 85-264Vac input, 0-100% load)				
PARD (20MHz)	< 50mVpp			< 100mVpp	
Hold-up Time	> 41ms @ 120Vac, > 70ms @ 230Vac	> 34ms @ 120Vac, > 65ms @ 230Vac	> 28ms @ 120Vac & 230Vac	> 30ms @ 120Vac & 230Vac	> 23ms @ 120vac & 230Vac
INPUT					
Phase Input	Single Phase				
Input Voltage Range	85-276Vac (DC input range 88-375Vdc) ¹⁾	85-264Vac (DC input range 88-375Vdc) ¹⁾	85-276Vac (DC input range 88-375Vdc) ¹⁾		85-264Vac
Input Frequency	47-63Hz				
Input Current	< 0.90A @ 120Vac, < 0.60A @ 230Vac	< 1.12A @ 120Vac, < 0.62A @ 230Vac	< 2.26A @ 120Vac, < 1.25A @ 230Vac	< 4.60A @ 120Vac, < 2.50A @ 230Vac	< 10.10A @ 120Vac, < 6.00A @ 230Vac
Efficiency ²⁾ at 100% Load	> 90.1% @ 120Vac, > 90.0% @ 230Vac	> 91.6% @ 120Vac, > 92.7% @ 230Vac	> 92.6% @ 120Vac, > 93.5% @ 230Vac	> 92.2% @ 120Vac, > 93.4% @ 230Vac	> 93.6% @ 120Vac, > 94.6% @ 230Vac
Max Inrush Current (Cold Start)	< 7A @ 120Vac, < 13A @ 230Vac	< 15A @ 120Vac & 230Vac	< 10A @ 120Vac & 230Vac	< 13A @ 120Vac & 230Vac	< 13A @ 120Vac, < 20A @ 230Vac
Power Factor	> 0.95 @ 120Vac, > 0.80 @ 230Vac	> 0.99 @ 120Vac, > 0.91 @ 230Vac	> 0.98 @ 120Vac, > 0.92 @ 230Vac	> 0.92 @ 120Vac, > 0.87 @ 230Vac	> 0.97 @ 120Vac, > 0.95 @ 230Vac
Leakage Current (264Vac, 50Hz)	TT/TN	< 0.36mA	< 0.45mA	< 0.74mA	< 0.80mA
	IT	< 0.95mA	< 1.08mA	< 1.29mA	< 2.00mA
MECHANICAL					
Case Cover / Chassis	Aluminium				
Dimensions (L x W x D)	124 x 32 x 102 mm (4.88" x 1.26" x 4.02")	124 x 40 x 117 mm (4.88" x 1.57" x 4.61")	124 x 60 x 117 mm (4.88" x 2.36" x 4.61")	124 x 82 x 127 mm (4.88" x 3.23" x 5.00")	124 x 125 x 133.6 mm (4.88" x 4.92" x 5.26")
Unit Weight	0.50 kg (1.10 lb)	0.63 kg (1.39 lb)	0.94 kg (2.07 lb)	1.40 kg (3.09 lb)	2.87 kg (6.33 lb)
Cooling System	Convection				
MTBF ³⁾	> 2,000,000 hrs	> 1,800,000 hrs	> 1,400,000 hrs	> 778,800 hrs	> 513,800 hrs
ENVIRONMENT					
Operating Temperature	-25°C to +70°C				
Storage Temperature	-40°C to +85°C				
Power De-rating	> 60°C (2.5% / °C)				
Operating Humidity	5 to 95% RH (Non-Condensing)				
Operating Altitude	0 to 5,000 m (0 to 16,400 ft); IEC/EN 61558: 0 to 2,500 m (0 to 8,200 ft)				

Dimensions Reference

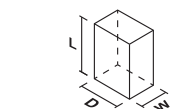

Notes

- 1) All models are certified for DC input. DC input is not applicable for DRM-24V960W1PN.
- 2) At 25°C ambient temperature by vertical mounting orientation.
- 3) MTBF as per Telcordia SR-332 (Confidence level: 90%, I/P: 100Vac, O/P: 100% load) for vertical mounting orientation.
- 4) All parameters are specified at 25°C ambient temperature unless otherwise indicated.

CliQ VA DIN Rail Power Supply

24V Output



HIGHLIGHTS & FEATURES

- Universal AC input voltage range
- LCD display monitoring the output current / voltage / peak current and temperature
- Life time expectancy alarm signal and monitoring
- Built-in active PFC with up to 94% efficiency
- Power Boost of 150% up to 7 seconds
- Advanced Power Boost (APB)
- DC OK Contact and LED indicator for DC OK/ Overload
- Conformal coating on PCBAs to protect against common dust and chemical pollutants

GENERAL SPECIFICATIONS

	NEW	NEW	NEW
OUTPUT	DRV-24V120W1PN	DRV-24V240W1PN	DRV-24V480W1PN
Output Voltage	24V	24V	24V
Output Voltage Range	24-28V	24-28V	24-28V
Output Current	5.0-4.28A	10.0-8.57A	20.0-17.0A
Output Power	120W	240W	480W
Line Regulation	20mV (@ 85-264Vac input, 100% load)	10mV (@ 85-276Vac input, 100% load)	
Load Regulation	100mV (@ 85-264Vac input, 0-100% load)	100mV (@ 85-276Vac input, 0-100% load)	
PARD (20MHz)	< 50mVpp	< 50mVpp	< 100mVpp
Hold-up Time	> 34ms @ 120Vac, > 65ms @ 230Vac	> 28ms @ 120Vac & 230Vac	> 30ms @ 120Vac & 230Vac
INPUT			
Phase Input	Single Phase		
Input Voltage Range	85-264Vac (DC input range 88-375Vdc) ¹⁾	85-276Vac (DC input range 88-375Vdc) ¹⁾	
Input Frequency	47-63Hz		
Input Current	< 1.13A @ 120Vac, < 0.63A @ 230Vac	< 2.22A @ 120Vac, < 1.21A @ 230Vac	< 4.60A @ 120Vac, < 2.50A @ 230Vac
Efficiency ²⁾ at 100% Load	> 90.3% @ 120Vac, > 91.2% @ 230Vac	> 92.6% @ 120Vac, > 93.5% @ 230Vac	> 92.2% @ 120Vac, > 93.4% @ 230Vac
Max Inrush Current (Cold Start)	< 15A @ 120Vac & 230Vac	< 10A @ 120Vac & 230Vac	< 13A @ 120Vac & 230Vac
Power Factor	> 0.99 @ 120Vac, > 0.91 @ 230Vac	> 0.98 @ 120Vac, > 0.92 @ 230Vac	> 0.92 @ 120Vac, > 0.87 @ 230Vac
Leakage Current (264Vac, 50Hz)	TT/TN	< 0.45mA	< 0.80mA
	IT	< 1.08mA	< 2.00mA
MECHANICAL			
Case Cover / Chassis	Aluminium & Plastic / Aluminium		
Dimensions (L x W x D)	124 x 60 x 139 mm (4.88" x 2.36" x 5.47")	124 x 60 x 139 mm (4.88" x 2.36" x 5.47")	124 x 82 x 149 mm (4.88" x 3.23" x 5.87")
Unit Weight	0.75 kg (1.65 lb)	1.02 kg (2.25 lb)	1.45 kg (3.20 lb)
Cooling System	Convection		
MTBF ³⁾	> 1,400,000 hrs	> 1,200,000 hrs	> 700,000 hrs
ENVIRONMENT			
Operating Temperature	-25°C to +70°C		
Storage Temperature	-40°C to +85°C		
Power De-rating	> 60°C (2.5% / °C)		
Operating Humidity	5 to 95% RH (Non-Condensing)		
Operating Altitude	0 to 5,000 m (0 to 16,400 ft)		

Dimensions Reference

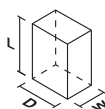

Notes

- 1) All models are certified for DC input.
- 2) At 25°C ambient temperature by vertical mounting orientation.
- 3) MTBF as per Telcordia SR-332 (Confidence level: 90%, I/P: 100Vac, O/P: 100% load) for vertical mounting orientation.
- 4) All parameters are specified at 25°C ambient temperature unless otherwise indicated.

Lyte DIN Rail Power Supply

24V, 48V Output



LYTE

HIGHLIGHTS & FEATURES

- Universal AC input voltage range
- High power density
- Built-in constant current circuit for reactive loads
- Conforms to harmonic current IEC/EN 61000-3-2, Class A
- Built-in DC OK relay contact (for DRL-□□□W1AS)
- Compliance to SEMI F47 @ 200Vac
- 15kV common mode & 8kV differential mode ESD immunity
- Conformal coating on PCBAs to protect against common dust and chemical pollutants

GENERAL SPECIFICATIONS

OUTPUT	DRL-24V120W1A□	DRL-24V240W1A□	DRL-24V480W1A□	DRL-48V120W1A□
Output Voltage	24V	24V	24V	48V
Output Voltage Range	22-28V	22-28V	22-28V	44-56V
Output Current	5.0A	10.0A	20.0A	2.50A
Output Power	120W	240W	480W	120W
Line Regulation	< 0.5% (@ 85-264Vac input, 100% load)			
Load Regulation (0-100% Load)	< 1.0%	< 1.0% @ -10°C to +70°C < 1.5% @ -20°C to -10°C	< 1.5% @ -10°C to +70°C < 2.0% @ -20°C to -10°C	< 1.0%
PARD (20MHz)	< 120mVpp @ -10°C to +70°C, < 240mVpp @ -20°C to -10°C	< 120mVpp @ 0°C to +70°C, < 240mVpp @ -10°C to 0°C, < 360mVpp @ -20°C to -10°C		< 150mVpp @ -10°C to +70°C, < 300mVpp @ -20°C to -10°C
Hold-up Time	20ms typ. @ 115Vac, 90ms typ. @ 230Vac	10ms typ. @ 115Vac, 16ms typ. @ 230Vac		20ms typ. @ 115Vac, 90ms typ. @ 230Vac
INPUT				
Phase Input	Single Phase			
Input Voltage Range	85-264Vac (DC input range 120-375Vdc) ¹⁾			
Input Frequency	47-63Hz			
Input Current	2.2A typ. @ 115Vac, 1.2A typ. @ 230Vac	2.8A typ. @ 115Vac, 1.4A typ. @ 230Vac	5.4A typ. @ 115Vac, 2.7A typ. @ 230Vac	2.2A typ. @ 115Vac, 1.2A typ. @ 230Vac
Efficiency ²⁾ at 100% Load	85.0% typ. @ 115Vac, 88.0% typ. @ 230Vac	88.0% typ. @ 115Vac, 90.0% typ. @ 230Vac	85.0% typ. @ 115Vac, 88.0% typ. @ 230Vac	89.0% typ. @ 115Vac, 90.0% typ. @ 230Vac
Max Inrush Current (Cold Start)	20A typ. @ 115Vac, 40A typ. @ 230Vac		40A typ. @ 115Vac, 80A typ. @ 230Vac	20A typ. @ 115Vac, 40A typ. @ 230Vac
Power Factor	Conform to EN 61000-3-2	> 0.95 @ 115Vac & 230Vac		Conform to EN 61000-3-2
Leakage Current	< 0.25mA @ 264Vac	< 1mA @ 264Vac		< 0.25mA @ 264Vac
MECHANICAL				
Case Cover / Chassis	SGCC / Aluminium			
Dimensions (L x W x D)	123.6 x 40 x 117.6 mm (4.87" x 1.57" x 4.63")	123.6 x 60 x 117.6 mm (4.87" x 2.36" x 4.63")	123.6 x 85.5 x 128.5 mm (4.87" x 3.37" x 5.06")	123.6 x 40 x 117.6 mm (4.87" x 1.57" x 4.63")
Unit Weight	0.54 kg (1.19 lb)	0.80 kg (1.76 lb)	1.30 kg (2.86 lb)	0.54 kg (1.19 lb)
Cooling System	Convection			
MTBF ³⁾	> 700,000 hrs	> 700,000 hrs	> 700,000 hrs	> 700,000 hrs
ENVIRONMENT				
Operating Temperature	-20°C to +70°C			
Storage Temperature	-40°C to +85°C			
Power De-rating	120W: < -10°C (2% / °C) & > 40°C (1.67% / °C) @ 115Vac; < -10°C (2% / °C) & > 50°C (2.5% / °C) @ 230Vac 240W & 480W: > 40°C (1.67% / °C) @ 115Vac; > 50°C (2.5% / °C) @ 230Vac			
Operating Humidity	5 to 95% RH (Non-Condensing)			
Operating Altitude	Industrial Application: 0 to 2,000 m (0 to 6,560 ft) ITE Application: 0 to 5,000 m (0 to 16,400 ft)			

Dimensions Reference

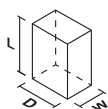

Notes

- 1) All models fulfill the test conditions for DC input. DC input safety approval can be obtained upon request.
- 2) At 25°C ambient temperature by vertical mounting orientation.
- 3) MTBF as per Telcordia SR-332 (Confidence level: 90%, I/P: 100Vac, O/P: 100% load) for vertical mounting orientation.
- 4) All parameters are specified at 25°C ambient temperature unless otherwise indicated.

Chrome DIN Rail Power Supply

5V, 12V Output

CHROME



HIGHLIGHTS & FEATURES

- Class II Double Isolation (No earth connection is required)
- Universal AC input voltage range and full power up to 55°C
- Power will not de-rate for the entire input voltage range
- Can be installed in compact cabinets
- NEC Class 2 and Limited Power Source (LPS) approvals (except DRC-12V100W1AZ)
- Conforms to harmonic current IEC/EN 61000-3-2, Class A
- Safety approval according to IEC/EN/UL 60950-1 (ITE standard) and UL 508 (Industrial standard)

GENERAL SPECIFICATIONS

OUTPUT	DRC-5V10W1A□	DRC-12V10W1A□	DRC-12V30W1A□	DRC-12V60W1A□	DRC-12V100W1AZ
Output Voltage	5V	12V	12V	12V	12V
Output Voltage Range	5V	12V	11.5-14.5V	11.5-14.0V	12-14V
Output Current	0-1.5A	0-0.83A	0-2.1A	0-4.5A	0-6.0A
Output Power	7.5W	10W	25.2W	54W	72W
Line Regulation	< 1.0% typ. (@ 90-264Vac, 100% load)				< 0.5% typ. (@ 90-264Vac, 100% load)
Load Regulation	< 2.0% typ. (@ 90-264Vac, 100% load)				< 1.0% typ. (@ 90-264Vac, 0-100% load)
PARD (20MHz)	< 150mVpp				< 100mVpp
Hold-up Time	> 10ms @ 115Vac, > 30ms @ 230Vac	> 10ms @ 115Vac, > 30ms @ 230Vac	> 25ms @ 115Vac, > 30ms @ 230Vac	> 16ms @ 115Vac, > 30ms @ 230Vac	> 20ms @ 115Vac, > 100ms @ 230Vac
INPUT					
Phase Input	Single Phase				
Input Voltage Range	90-264Vac				
Input Frequency	47-63Hz				
Input Current	< 0.3A @ 115Vac, < 0.2A @ 230Vac	< 0.3A @ 115Vac, < 0.2A @ 230Vac	< 0.8A @ 115Vac, < 0.6A @ 230Vac	< 1.5A @ 115Vac, < 0.8A @ 230Vac	< 1.5A @ 115Vac, < 0.9A @ 230Vac
Efficiency ¹⁾ at 100% Load	> 78.0% @ 115Vac, > 77.0% @ 230Vac	> 82.0% @ 115Vac & 230Vac	> 85.0% @ 115Vac & 230Vac	> 86.0% @ 115Vac & 230Vac	
Max Inrush Current (Cold Start)	< 15A @ 115Vac, < 30A @ 230Vac		< 25A @ 115Vac, < 50A @ 230Vac	< 30A @ 115Vac, < 60A @ 230Vac	< 30A @ 115Vac, < 65A @ 230Vac
Power Factor	Conform to EN 61000-3-2				
Leakage Current	< 0.25mA @ 240Vac				< 0.25mA @ 264Vac
MECHANICAL					
Case Cover / Chassis	Plastic				
Dimensions (L x W x D)	91 x 18 x 55.6 mm (3.58" x 0.71" x 2.19")	91 x 18 x 55.6 mm (3.58" x 0.71" x 2.19")	91 x 53 x 55.6 mm (3.58" x 2.09" x 2.19")	91 x 71 x 55.6 mm (3.58" x 2.80" x 2.19")	91 x 89.9 x 55.6 mm (3.58" x 3.54" x 2.19")
Unit Weight	0.06 kg (0.13 lb)	0.06 kg (0.13 lb)	0.14 kg (0.31 lb)	0.22 kg (0.49 lb)	0.36 kg (0.79 lb)
Cooling System	Convection				
MTBF ²⁾	> 500,000 hrs	> 500,000 hrs	> 500,000 hrs	> 500,000 hrs	> 500,000 hrs
ENVIRONMENT					
Operating Temperature	-25°C to +71°C				
Storage Temperature	-25°C to +85°C				-40°C to +85°C
Power De-rating	> 55°C (2.5% / °C)				
Operating Humidity	5 to 95% RH (Non-Condensing)				
Operating Altitude	0 to 2,000 m (0 to 6,560 ft)				

Dimensions Reference

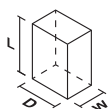

Notes

- 1) At 25°C ambient temperature by vertical mounting orientation.
- 2) MTBF as per Telcordia SR-332 (Confidence level: 90%, I/P: 100Vac, O/P: 100% load, Ta: 35°C) for vertical mounting orientation.
- 3) All parameters are specified at 25°C ambient temperature unless otherwise indicated.

Chrome DIN Rail Power Supply

24V Output



CHROME

HIGHLIGHTS & FEATURES

- Class II Double Isolation (No earth connection is required)
- Universal AC input voltage range and full power up to 55°C
- Power will not de-rate for the entire input voltage range
- Can be installed in compact cabinets
- NEC Class 2 and Limited Power Source (LPS) approvals
- Conforms to harmonic current IEC/EN 61000-3-2, Class A
- Safety approval according to IEC/EN/UL 60950-1 (ITE standard) and UL 508 (Industrial standard)
- Household appliance approvals IEC/EN 60335-1 (DRC-24V10W1HZ)

GENERAL SPECIFICATIONS

OUTPUT	DRC-24V10W1A□	DRC-24V10W1HZ	DRC-24V30W1A□	DRC-24V60W1A□	DRC-24V100W1A□
Output Voltage	24V	24V	24V	24V	24V
Output Voltage Range	24V	24V	23.52-24.48V	24-28V	22-24V
Output Current	0-0.42A	0-0.42A	0-1.25A	0-2.5A	0-3.8A
Output Power	10W	10W	30W	60W	91.2W
Line Regulation	< 1.0% typ. (@ 90-264Vac, 100% load)				
Load Regulation	< 2.0% typ. (@ 90-264Vac, 100% load)				
PARD (20MHz)	< 150mVpp				
Hold-up Time	> 10ms @ 115Vac, > 30ms @ 230Vac		> 25ms @ 115Vac, > 30ms @ 230Vac	> 16ms @ 115Vac, > 30ms @ 230Vac	> 10ms @ 115Vac, > 30ms @ 230Vac
INPUT					
Phase Input	Single Phase				
Input Voltage Range	90-264Vac				90-264Vac (DC input range 125-375Vdc)
Input Frequency	47-63Hz				
Input Current	< 0.3A @ 115Vac, < 0.2A @ 230Vac		< 0.8A @ 115Vac, < 0.6A @ 230Vac	< 1.5A @ 115Vac, < 1.0A @ 230Vac	< 2.2A @ 115Vac, < 1.0A @ 230Vac
Efficiency ¹⁾ at 100% Load	> 80.0% @ 115Vac & 230Vac		> 83.0% @ 115Vac & 230Vac	> 86.0% @ 115Vac & 230Vac	> 85.0% @ 115Vac, > 87.0% @ 230Vac
Max Inrush Current (Cold Start)	< 15A @ 115Vac, < 30A @ 230Vac		< 25A @ 115Vac, < 50A @ 230Vac	< 30A @ 115Vac, < 60A @ 230Vac	
Power Factor	Conform to EN 61000-3-2				
Leakage Current	< 0.25mA @ 240Vac				
MECHANICAL					
Case Cover / Chassis	Plastic				
Dimensions (L x W x D)	91 x 18 x 55.6 mm (3.58" x 0.71" x 2.19")	91 x 18 x 55.6 mm (3.58" x 0.71" x 2.19")	91 x 53 x 55.6 mm (3.58" x 2.09" x 2.19")	91 x 71 x 55.6 mm (3.58" x 2.80" x 2.19")	91 x 89.9 x 55.6 mm (3.58" x 3.54" x 2.19")
Unit Weight	0.065 kg (0.14 lb)	0.065 kg (0.14 lb)	0.14 kg (0.31 lb)	0.22 kg (0.49 lb)	0.35 kg (0.77 lb)
Cooling System	Convection				
MTBF ²⁾	> 500,000 hrs	> 500,000 hrs	> 500,000 hrs	> 500,000 hrs	> 500,000 hrs
ENVIRONMENT					
Operating Temperature	-25°C to +71°C				
Storage Temperature	-25°C to +85°C				
Power De-rating	> 55°C (2.5% / °C)				
Operating Humidity	5 to 95% RH (Non-Condensing)				
Operating Altitude	0 to 2,000 m (0 to 6,560 ft)				

Dimensions Reference

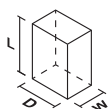

Notes

- 1) At 25°C ambient temperature by vertical mounting orientation.
- 2) MTBF as per Telcordia SR-332 (Confidence level: 90%, I/P: 100Vac, O/P: 100% load, Ta: 35°C) for vertical mounting orientation.
- 3) All parameters are specified at 25°C ambient temperature unless otherwise indicated.

Sync DIN Rail Power Supply

5V, 12V Output

sync



HIGHLIGHTS & FEATURES

- Ultra-compact size and galvanic isolation up to 3.0kVac between input to output and input to ground
- Universal AC input voltage range and full power from -10°C to +55°C operation
- Up to 89.0% efficiency
- Low earth leakage current < 0.5mA @ 264Vac
- Built-in DC OK relay contact option available
- Extreme low temperature cold start at -40°C
- NEC Class 2 / Limited Power Source (LPS) certified

GENERAL SPECIFICATIONS

OUTPUT	DRS-5V30W1NZ	DRS-5V50W1A□	DRS-5V50W1N□	DRS-12V50W1N□
Output Voltage	5V	5V	5V	12V
Output Voltage Range	5-5.5V	5-5.5V	5-5.5V	12-15V
Output Current	0-3.0A	0-6.0A	0-5.0A	0-4.0A
Output Power	15W	30W	25W	48W
Line Regulation	< 0.5% (@ 85-264Vac, 100% load)			
Load Regulation	< 1.0% (@ 85-264Vac, 0-100% load)			
PARD (20MHz)	< 75mVpp @ > 0°C to 70°C, < 150mVpp @ 0°C to -20°C	< 50mVpp @ > 0°C to 70°C, < 150mVpp @ 0°C to -20°C		< 50mVpp @ > 0°C to 70°C, < 100mVpp @ 0°C to -20°C
Hold-up Time	> 20ms @ 115Vac, > 100ms @ 230Vac			
INPUT				
Phase Input	Single Phase			
Input Voltage Range	85-264Vac (DC input range 120-375Vdc) ¹⁾			
Input Frequency	47-63Hz			
Input Current	< 0.40A @ 115Vac, < 0.20A @ 230Vac	< 0.60A @ 115Vac, < 0.40A @ 230Vac		< 0.90A @ 115Vac, < 0.55A @ 230Vac
Efficiency ²⁾ at 100% Load	> 79.0% @ 115Vac & 230Vac	> 82.0% @ 115Vac & 230Vac		> 88.0% @ 115Vac, > 89.0% @ 230Vac
Max Inrush Current (Cold Start)	< 20A @ 115Vac, < 40A @ 230Vac	< 35A @ 115Vac, < 65A @ 230Vac		< 25A @ 115Vac, < 50A @ 230Vac
Power Factor	Conform to EN 61000-3-2			
Leakage Current	< 0.5mA @ 264Vac	< 0.75mA @ 264Vac		< 0.5mA @ 264Vac
MECHANICAL				
Case Cover / Chassis	Plastic			
Dimensions (L x W x D)	75 x 21 x 89.5 mm (2.95" x 0.83" x 3.52")	75 x 30 x 89.5 mm (2.95" x 1.18" x 3.52")	75 x 30 x 89.5 mm (2.95" x 1.18" x 3.52")	75 x 30 x 89.5 mm (2.95" x 1.18" x 3.52")
Unit Weight	0.11 kg (0.24 lb)	0.16 kg (0.35 lb)	0.16 kg (0.35 lb)	0.18 kg (0.40 lb)
Cooling System	Convection			
MTBF ³⁾	> 700,000 hrs	> 700,000 hrs	> 700,000 hrs	> 700,000 hrs
ENVIRONMENT				
Operating Temperature	-20°C to +70°C			
Storage Temperature	-40°C to +85°C			
Power De-rating	< -10°C (2% / °C), > 55°C (3.33% / °C)			
Operating Humidity	5 to 95% RH (Non-Condensing)			
Operating Altitude	0 to 2,000 m (0 to 6,560 ft)			

Dimensions Reference

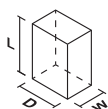

Notes

- 1) All models fulfill the test conditions for DC input. DC input safety approval can be obtained upon request.
- 2) At 25°C ambient temperature by vertical mounting orientation.
- 3) MTBF as per Telcordia SR-332 (Confidence level: 90%, I/P: 115Vac & 230Vac, O/P: 100% load) for vertical mounting orientation.
- 4) All parameters are specified at 25°C ambient temperature unless otherwise indicated.

Sync DIN Rail Power Supply

24V Output



sync

HIGHLIGHTS & FEATURES

- Ultra-compact size and galvanic isolation up to 3.0kVac between input to output and input to ground
- Universal AC input voltage and full power from -10°C to +55°C operation
- Up to 90.0% efficiency
- Low earth leakage current < 0.5mA @ 264Vac
- Built-in DC OK relay contact option available
- Extreme low temperature cold start at -40°C
- NEC Class 2 / Limited Power Source (LPS) certified

GENERAL SPECIFICATIONS

OUTPUT	DRS-24V30W1AZ	DRS-24V30W1NZ	DRS-24V50W1N□	DRS-24V100W1A□	DRS-24V100W1N□
Output Voltage	24V	24V	24V	24V	24V
Output Voltage Range	21.6-26.4V	24-28V	24-28V	24-28V	22-24V
Output Current	0-1.25A	0-1.25A	0-2.1A	0-4.0A	0-3.8A
Output Power	30W	30W	50W	96W	91.2W
Line Regulation	< 1.0%	< 0.5% (@ 85-264Vac, 100% load)			
Load Regulation	< 1.0%	< 1.0% (@ 85-264Vac, 0-100% load)			
PARD (20MHz)	< 150mVpp	< 75mVpp @ > 0°C to 70°C, < 150mVpp @ 0°C to -20°C	< 70mVpp @ > 0°C to 70°C, < 100mVpp @ 0°C to -20°C	< 50mVpp @ > 0°C to 70°C, < 100mVpp @ 0°C to -20°C	
Hold-up Time	> 20ms @ 230Vac	> 20ms @ 115Vac, > 100ms @ 230Vac		> 50ms @ 115Vac & 230Vac	
INPUT					
Phase Input	Single Phase				
Input Voltage Range	85-264Vac	85-264Vac (DC input range 120-375Vdc) ¹⁾			
Input Frequency	47-63Hz				
Input Current	< 0.80A @ 115Vac, < 0.40A @ 230Vac	< 0.55A @ 115Vac, < 0.35A @ 230Vac	< 0.95A @ 115Vac, < 0.55A @ 230Vac	< 1.20A @ 115Vac, < 0.60A @ 230Vac	
Efficiency ²⁾ at 100% Load	88.0% typ. @ 230Vac	> 87.5% @ 115Vac, > 88.0% @ 230Vac	> 89.0% @ 115Vac, > 90.0% @ 230Vac	> 89.0% @ 115Vac & 230Vac	
Max Inrush Current (Cold Start)	< 60A @ 230Vac	< 20A @ 115Vac, < 40A @ 230Vac	< 30A @ 115Vac, < 50A @ 230Vac	< 25A @ 115Vac, < 40A @ 230Vac	
Power Factor	Conform to EN 61000-3-2				> 0.97 @ 115Vac, > 0.90 @ 230Vac
Leakage Current	< 0.5mA @ 240Vac	< 0.5mA @ 264Vac			
MECHANICAL					
Case Cover / Chassis	Plastic				
Dimensions (L x W x D)	75 x 21 x 89.5 mm (2.95" x 0.83" x 3.52")	75 x 21 x 89.5 mm (2.95" x 0.83" x 3.52")	75 x 30 x 89.5 mm (2.95" x 1.18" x 3.52")	75 x 45 x 100 mm (2.95" x 1.77" x 3.94")	75 x 45 x 100 mm (2.95" x 1.77" x 3.94")
Unit Weight	0.10 kg (0.22 lb)	0.11 kg (0.24 lb)	0.18 kg (0.40 lb)	0.325 kg (0.72 lb)	0.325 kg (0.72 lb)
Cooling System	Convection				
MTBF ³⁾	> 700,000 hrs	> 700,000 hrs	> 700,000 hrs	> 700,000 hrs	> 700,000 hrs
ENVIRONMENT					
Operating Temperature	-20°C to +70°C				
Storage Temperature	-40°C to +85°C				
Power De-rating	< -10°C (5% / °C), > 55°C (3.33% / °C)	< -10°C (2% / °C), > 55°C (3.33% / °C)			
Operating Humidity	5 to 95% RH (Non-Condensing)				
Operating Altitude	0 to 2,000 m (0 to 6,560 ft)				

Dimensions Reference

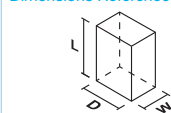

Notes

- 1) All models fulfill the test conditions for DC input. DC input safety approval can be obtained upon request.
- 2) At 25°C ambient temperature by vertical mounting orientation.
- 3) MTBF as per Telcordia SR-332 (Confidence level: 90%, I/P: 115Vac & 230Vac, O/P: 100% load) for vertical mounting orientation.
- 4) All parameters are specified at 25°C ambient temperature unless otherwise indicated.

Delta Industrial Power Supplies

Panel Mount Power Supply



AR

PMT



- AC input voltage selectable by switch (Universal AC input voltage range for selected models only)
- Conforms to harmonic current IEC/EN 61000-3-2, Class A (except 200W and 350W)
- High MTBF > 700,000 hrs per Telcordia SR-332
- Versatile configuration options:
 - Open Frame (35W and 50W, except for 5V/35W, 5V/50W and 15V/50W models)
 - L Frame (35W-200W)
 - Enclosed



AR

PMT2



- Household appliance approvals to IEC/EN 60335-1, IEC/EN 61558-1 and IEC/EN 61558-2-16
- Universal AC input voltage range (except 150W)
- No load power consumption
- Low profile design: 30mm height
- Over Voltage Category III
- Extreme low temperature cold start at -40°C
- High MTBF > 700,000 hrs per Telcordia SR-332



AR

PMC



- Universal AC input voltage range
- Power will not de-rate for the entire input voltage range (except PMC-□V600W1BA)
- Full corrosion resistant aluminium casing (except PMC-05V015W1AA and PMC-□V600W1BA)
- Conforms to harmonic current IEC/EN 61000-3-2, Class A (except PMC-24V150W1A□)
- High MTBF > 700,000 hrs per Telcordia SR-332
- Safety approval according to IEC/EN/UL 60950-1 (ITE standard) and EMI to EN 55032, Class B
- Also available: IP20 and Front Face connectors for selected models



AR

PMH



- Household appliance approvals to IEC/EN 60335-1, IEC/EN 61558-1 and IEC/EN 61558-2-16
- Universal AC input voltage range
- Full corrosion resistant aluminium casing
- High MTBF > 700,000 hrs per Telcordia SR-332
- Low profile design for 1U installation (for PMH-12V100WCL□, PMH-24V100WCL□, PMH-24V100WCM□ and PMH-24V150WCL□)
- NEC Class 2 options available



AR

PMF



- Universal AC input voltage range
- Built-in active PFC and automatic fan speed control
- Full corrosion resistant aluminium casing
- Conforms to harmonic current IEC/EN 61000-3-2, Class D
- Remote ON/OFF is available as an option
- Short Circuit / Overvoltage / Overcurrent / Over Temperature Protections

Delta Industrial Power Supplies

Panel Mount Power Supply



AR

PMR



- Universal AC input voltage range
- Full corrosion resistant aluminium casing
- Built-in active PFC and conforms to harmonic current IEC/EN 61000-3-2, Class A and Class D
- Low profile design for 1U installation
- Built-in DC OK relay contact and redundancy operation (PMR-□V320WDBA and PMR-□V320WDCA)



AR

PMU



- AC input voltage selectable by switch
- LED indicators for DC OK (Green) and Battery Reverse Polarity Connection (Red)
- Zero switch over time from loss of AC to battery operation
- Conforms to harmonic current IEC/EN 61000-3-2, Class A
- High MTBF > 700,000 hrs per Telcordia SR-332
- Monitoring signals for AC OK, DC OK and Battery Low indication



AR

MDS



- Compliant with IEC 60601-1-2 4th Ed. requirements
- Suitable for type BF medical product
- Safety approvals for medical and IT applications
- Remote on/off control
- Power Good signal
- High MTBF > 500,000 hrs as per Telcordia SR-332

PAGES 77-78



AR

MEB



- Full power from 90Vac to 264Vac, up to 50°C ambient
- Up to 500K hours MTBF
- 2 × MOOPP isolation, Suitable for type BF medical products
- Current sharing and 5V/2A standby output
- Compliant with IEC 60601-1-2 4th Ed. Requirements
- PMBus Ver 1.3 supported
- Intelligent fan speed control

PAGE 79

PMT Panel Mount Power Supply

4.2V, 5V Output



PMT

HIGHLIGHTS & FEATURES

- AC input voltage range selectable by switch (Universal AC input voltage range for selected models)
- Conforms to harmonic current IEC/EN 61000-3-2, Class A for selected models
- High MTBF > 700,000 hrs per Telcordia SR-332
- Short Circuit / Overvoltage / Overload / Over Temperature Protections
- Versatile configuration options (for 35W and 50W):
 - L Frame
 - Enclosed

GENERAL SPECIFICATIONS

OUTPUT	PMT-4V350W1A□	PM□-5V35W1A□	PM□-5V50W1A□	PMT-5V350W1A□
Output Voltage	4.2V	5V	5V	5V
Output Voltage Range	3.78-4.70V	4.50-5.50V	4.50-5.50V	4.50-5.50V
Output Current	60.0A	7.0A	10.0A	60.0A
Output Power	252W	35W	50W	300W
Line Regulation	< 0.5%			
Load Regulation	< 2.5%	< 1.0%		< 2.5%
PARD (20MHz)	< 150mVpp	< 80mVpp		< 150mVpp
Hold-up Time	16ms typ. @ 115Vac, 20ms typ. @ 230Vac	20ms typ. @ 115Vac, 100ms typ. @ 230Vac		16ms typ. @ 115Vac, 20ms typ. @ 230Vac
INPUT				
Phase Input	Single Phase			
Input Voltage Range	90-132Vac, 180-264Vac (Selectable by Switch)	85-264Vac		90-132Vac, 180-264Vac (Selectable by Switch)
Input Frequency	47-63Hz			
Input Current	7.00A typ. @ 115Vac, 4.00A typ. @ 230Vac	0.75A typ. @ 115Vac, 0.50A typ. @ 230Vac	1.10A typ. @ 115Vac, 0.65A typ. @ 230Vac	7.00A typ. @ 115Vac, 4.00A typ. @ 230Vac
Efficiency ¹⁾ at 100% Load	76.0% typ. @ 230Vac	81.0% typ. @ 230Vac	82.0% typ. @ 230Vac	78.0% typ. @ 230Vac
Max Inrush Current (Cold Start)	40A typ. @ 115Vac, 60A typ. @ 230Vac	45A typ. @ 230Vac		40A typ. @ 115Vac, 60A typ. @ 230Vac
Power Factor	NA	Conform to EN 61000-3-2		NA
Leakage Current	< 1mA @ 240Vac	< 0.5mA @ 240Vac	< 1mA @ 240Vac	
MECHANICAL				
Case Cover / Chassis	Aluminium	SGCC / Aluminium		Aluminium
Dimensions (L x W x H)	215 x 115 x 50 mm (8.46" x 4.53" x 1.97")	98 x 98 x 38 mm (3.86" x 3.86" x 1.50")	98 x 98 x 38 mm (3.86" x 3.86" x 1.50")	215 x 115 x 50 mm (8.46" x 4.53" x 1.97")
Unit Weight	0.81 kg (1.79 lb)	0.23 kg (0.51 lb)	0.23 kg (0.51 lb)	0.81 kg (1.79 lb)
Cooling System	Forced Air (Built-in Fan)	Convection		Forced Air (Built-in Fan)
MTBF ²⁾	> 700,000 hrs	> 700,000 hrs	> 700,000 hrs	> 700,000 hrs
ENVIRONMENT				
Operating Temperature	-10°C to +70°C			
Storage Temperature	-25°C to +85°C			
Power De-rating	> 50°C (4% / °C), > 60°C (1% / °C)	> 50°C (2.5% / °C)		> 50°C (4% / °C), > 60°C (1% / °C)
Operating Humidity	5 to 95% RH (Non-Condensing)			
Operating Altitude	0 to 5,000 m (0 to 16,400 ft)			

Dimensions Reference

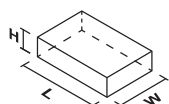

Notes

- 1) At 25°C ambient temperature by vertical mounting orientation.
- 2) MTBF as per Telcordia SR-332 (Confidence level: 90%, I/P: 100Vac, O/P: 100% load, Ta: 35°C). For PMT-4V350W1A□ and PMT-5V350W1A□ models, MTBF calculations do not include fan life time.
- 3) All parameters are specified at 25°C ambient temperature unless otherwise indicated.

PMT Panel Mount Power Supply

12V Output



PMT

HIGHLIGHTS & FEATURES

- AC input voltage range selectable by switch (Universal AC input voltage range for selected models)
- Conforms to harmonic current IEC/EN 61000-3-2, Class A
- High MTBF > 700,000 hrs per Telcordia SR-332
- Short Circuit / Overvoltage / Overload / Over Temperature Protections
- Versatile configuration options (for 150W and below):
 - Open Frame (35W and 50W)
 - L Frame
 - Enclosed

GENERAL SPECIFICATIONS

OUTPUT	PM□-12V35W1A□	PM□-12V50W1A□	PM□-12V100W1A□	PM□-12V150W1A□	PMT-12V350W1A□
Output Voltage	12V	12V	12V	12V	12V
Output Voltage Range	11-14V	11-14V	11.4-13.2V	11.4-13.5V	10.8-13.2V
Output Current	2.92A	4.17A	8.5A	12.5A	29.0A
Output Power	35W	50W	102W	150W	348W
Line Regulation	< 0.5%				± 0.5% typ.
Load Regulation	< 1.0%		< 0.5%		± 1.0% typ.
PARD (20MHz)	< 100mVpp		< 120mVpp		< 150mVpp
Hold-up Time	16.7ms typ. @ 115Vac		25ms typ. @ 115Vac, 30ms typ. @ 230Vac	20ms typ. @ 115Vac, 24ms typ. @ 230Vac	12ms typ. @ 115Vac, 16ms typ. @ 230Vac
INPUT					
Phase Input	Single Phase				
Input Voltage Range	90-264Vac		90-132Vac, 180-264Vac (Selectable by Switch)		
Input Frequency	47-63Hz				
Input Current	0.75A typ. @ 115Vac, 0.50A typ. @ 230Vac	1.10A typ. @ 115Vac, 0.70A typ. @ 230Vac	2.00A typ. @ 115Vac, 1.20A typ. @ 230Vac	3.00A typ. @ 115Vac, 2.00A typ. @ 230Vac	7.00A typ. @ 115Vac, 4.00A typ. @ 230Vac
Efficiency ¹⁾ at 100% Load	84.0% typ. @ 115Vac & 230Vac		83.0% typ. @ 115Vac & 230Vac	87.5% typ. @ 230Vac	86.0% typ. @ 230Vac
Max Inrush Current (Cold Start)	30A typ. @ 115Vac, 60A typ. @ 230Vac	30A typ. @ 115Vac, 65A typ. @ 230Vac	36A typ. @ 230Vac	45A typ. @ 230Vac	50A typ. @ 115Vac, 60A typ. @ 230Vac
Power Factor	Conform to EN 61000-3-2				
Leakage Current	< 1mA @ 240Vac		< 0.5mA @ 240Vac		< 3.5mA @ 240Vac
MECHANICAL					
Case Cover / Chassis	SGCC / Aluminium				
Dimensions (L x W x H)	98 x 98 x 38 mm (3.86" x 3.86" x 1.50")	98 x 98 x 38 mm (3.86" x 3.86" x 1.50")	158 x 97 x 38 mm (6.22" x 3.82" x 1.50")	178 x 97 x 38 mm (7.01" x 3.82" x 1.50")	215 x 115 x 50 mm (8.46" x 4.53" x 1.97")
Unit Weight	0.22 kg (0.49 lb)	0.23 kg (0.51 lb)	0.36 kg (0.79 lb)	0.48 kg (1.06 lb)	0.82 kg (1.81 lb)
Cooling System	Convection				Forced Air (Built-in Fan)
MTBF ²⁾	> 700,000 hrs	> 700,000 hrs	> 700,000 hrs	> 700,000 hrs	> 700,000 hrs
ENVIRONMENT					
Operating Temperature	-10°C to +70°C				
Storage Temperature	-25°C to +85°C				
Power De-rating	> 50°C (2.5% / °C)				
Operating Humidity	5 to 95% RH (Non-Condensing)				
Operating Altitude	0 to 5,000 m (0 to 16,400 ft)				

Dimensions Reference

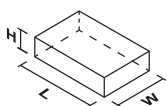

Notes

- 1) At 25°C ambient temperature by vertical mounting orientation.
- 2) MTBF as per Telcordia SR-332 (Confidence level: 90%, I/P: 100Vac, O/P: 100% load, Ta: 35°C). For PMT-12V350W1A□ models, MTBF calculations do not include fan life time.
- 3) All parameters are specified at 25°C ambient temperature unless otherwise indicated.

15V, 24V Output



PMT

HIGHLIGHTS & FEATURES

- AC input voltage range selectable by switch (Universal AC input voltage range for selected models)
- Conforms to harmonic current IEC/EN 61000-3-2, Class A
- High MTBF > 700,000 hrs per Telcordia SR-332
- Short Circuit / Overvoltage / Overload / Over Temperature Protections
- Versatile configuration options:
 - Open Frame (35W and 50W, except PM□-15V50W1A□)
 - L Frame
 - Enclosed

GENERAL SPECIFICATIONS

OUTPUT	PM□-15V50W1A□	PM□-24V35W1A□	PM□-24V50W1A□	PM□-24V100W1A□	PM□-24V150W1A□
Output Voltage	15V	24V	24V	24V	24V
Output Voltage Range	13.5-16.5V	22-28V	22-28V	22.8-26.4V	22.8-27.6V
Output Current	3.4A	1.46A	2.1A	4.5A	6.5A
Output Power	51W	35W	50W	108W	156W
Line Regulation	< 0.5%				
Load Regulation	< 0.5%	< 1.0%		< 0.5%	
PARD (20MHz)	< 150mVpp	< 100mVpp		< 120mVpp	
Hold-up Time	20ms typ. @ 115Vac, 100ms typ. @ 230Vac	16.7ms typ. @ 115Vac		25ms typ. @ 115Vac, 30ms typ. @ 230Vac	20ms typ. @ 115Vac, 24ms typ. @ 230Vac
INPUT					
Phase Input	Single Phase				
Input Voltage Range	85-264Vac	90-264Vac		90-132Vac, 180-264Vac (Selectable by Switch)	
Input Frequency	47-63Hz				
Input Current	1.10A typ. @ 115Vac, 0.65A typ. @ 230Vac	0.75A typ. @ 115Vac, 0.50A typ. @ 230Vac	1.10A typ. @ 115Vac, 0.65A typ. @ 230Vac	2.00A typ. @ 115Vac, 1.20A typ. @ 230Vac	3.00A typ. @ 115Vac, 2.00A typ. @ 230Vac
Efficiency ¹⁾ at 100% Load	85.5% typ. @ 230Vac	85.0% typ. @ 115Vac & 230Vac	86.0% typ. @ 115Vac & 230Vac	89.0% typ. @ 230Vac	
Max Inrush Current (Cold Start)	45A typ. @ 230Vac	30A typ. @ 115Vac, 60A typ. @ 230Vac		36A typ. @ 230Vac	45A typ. @ 230Vac
Power Factor	Conform to EN 61000-3-2				
Leakage Current	< 0.5mA @ 240Vac	< 1mA @ 240Vac		< 0.5mA @ 240Vac	
MECHANICAL					
Case Cover / Chassis	SGCC / Aluminium				
Dimensions (L x W x H)	98 x 98 x 38 mm (3.86" x 3.86" x 1.50")	98 x 98 x 38 mm (3.86" x 3.86" x 1.50")	98 x 98 x 38 mm (3.86" x 3.86" x 1.50")	158 x 97 x 38 mm (6.22" x 3.82" x 1.50")	178 x 97 x 38 mm (7.01" x 3.82" x 1.50")
Unit Weight	0.23 kg (0.51 lb)	0.22 kg (0.49 lb)	0.24 kg (0.53 lb)	0.36 kg (0.79 lb)	0.48 kg (1.06 lb)
Cooling System	Convection				
MTBF ²⁾	> 700,000 hrs	> 700,000 hrs	> 700,000 hrs	> 700,000 hrs	> 700,000 hrs
ENVIRONMENT					
Operating Temperature	-10°C to +70°C				
Storage Temperature	-25°C to +85°C				
Power De-rating	> 50°C (2.5% / °C)				
Operating Humidity	5 to 95% RH (Non-Condensing)				
Operating Altitude	0 to 5,000 m (0 to 16,400 ft)				

Dimensions Reference

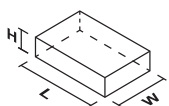

Notes

- 1) At 25°C ambient temperature by vertical mounting orientation.
- 2) MTBF as per Telcordia SR-332 (Confidence level: 90%, I/P: 100Vac, O/P: 100% load, Ta: 35°C).
- 3) All parameters are specified at 25°C ambient temperature unless otherwise indicated.

PMT Panel Mount Power Supply

24V Output



PMT

HIGHLIGHTS & FEATURES

- AC input voltage range selectable by switch
- Full corrosion resistant aluminium casing
- High Efficiency > 87.0% @ 230Vac
- High MTBF > 700,000 hrs per Telcordia SR-332
- Short Circuit / Overvoltage / Overload / Over Temperature Protections
- Versatile configuration options (for 200W):
 - L Frame
 - Enclosed

GENERAL SPECIFICATIONS

OUTPUT	PM□-24V200W1A□	PMT-24V350W1AG	PMT-24V350W1AM	PMT-24V350W1AK	PMT-24V350W1AR
Output Voltage	24V	24V	24V	24V	24V
Output Voltage Range	21.6-26.4V	20.0-26.4V	20.0-26.4V	20.0-26.4V	20.0-26.4V
Output Current	8.8A	14.6A	14.6A	14.6A	14.6A
Output Power	211.2W	350.4W	350.4W	350.4W	350.4W
Line Regulation	< 0.5%				
Load Regulation	< 0.5%				
PARD (20MHz)	< 150mVpp				
Hold-up Time	20ms typ. @ 115Vac, 24ms typ. @ 230Vac	16ms typ. @ 115Vac, 20ms typ. @ 230Vac			
INPUT					
Phase Input	Single Phase				
Input Voltage Range	90-132Vac, 180-264Vac (Selectable by Switch)				
Input Frequency	47-63Hz				
Input Current	4.5A typ. @ 115Vac, 2.5A typ. @ 230Vac	7.0A typ. @ 115Vac, 4.0A typ. @ 230Vac	7.0A typ. @ 115Vac, 4.0A typ. @ 230Vac	7.0A typ. @ 115Vac, 4.0A typ. @ 230Vac	7.0A typ. @ 115Vac, 4.0A typ. @ 230Vac
Efficiency ¹⁾ at 100% Load	88.5% typ. @ 230Vac	87.0% typ. @ 230Vac			
Max Inrush Current (Cold Start)	55A typ. @ 230Vac	50A typ. @ 115Vac, 60A typ. @ 230Vac			
Power Factor	NA				
Leakage Current	< 0.25mA @ 240Vac	< 3.5mA @ 240Vac			
MECHANICAL					
Case Cover / Chassis	Aluminium				
Dimensions (L x W x H)	215 x 115 x 50 mm (8.46" x 4.53" x 1.97")	215 x 115 x 50 mm (8.46" x 4.53" x 1.97")	215 x 115 x 50 mm (8.46" x 4.53" x 1.97")	215 x 115 x 50 mm (8.46" x 4.53" x 1.97")	215 x 115 x 50 mm (8.46" x 4.53" x 1.97")
Unit Weight	0.63 kg (1.39 lb)	0.82 kg (1.81 lb)	0.82 kg (1.81 lb)	0.82 kg (1.81 lb)	0.82 kg (1.81 lb)
Cooling System	Convection	Forced Air (Built-in Fan)			
MTBF ²⁾	> 700,000 hrs	> 700,000 hrs	> 700,000 hrs	> 700,000 hrs	> 700,000 hrs
ENVIRONMENT					
Operating Temperature	-10°C to +60°C	-10°C to +70°C			
Storage Temperature	-25°C to +85°C				
Power De-rating	> 40°C (2.5% / °C)	> 50°C (2.5% / °C)			
Operating Humidity	5 to 95% RH (Non-Condensing)				
Operating Altitude	0 to 5,000 m (0 to 16,400 ft)				

Dimensions Reference

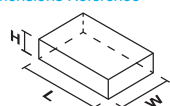

Notes

- 1) At 25°C ambient temperature by vertical mounting orientation.
- 2) MTBF as per Telcordia SR-332 (Confidence level: 90%, I/P: 100Vac, O/P: 100% load, Ta: 35°C). For PMT-24V350W1A□ models, MTBF calculations do not include fan life time.
- 3) All parameters are specified at 25°C ambient temperature unless otherwise indicated.

36V, 48V, Dual Output



PMT

HIGHLIGHTS & FEATURES

- AC input voltage range selectable by switch
- Conforms to harmonic current IEC/EN 61000-3-2, Class A for selected models
- High MTBF > 700,000 hrs per Telcordia SR-332
- Short Circuit / Overvoltage / Overload / Over Temperature Protections
- Versatile configuration options:
 - L Frame
 - Enclosed

GENERAL SPECIFICATIONS

OUTPUT	PMT-36V350W1A□	PM□-48V150W1A□	PMT-48V350W1A□	PM□-D1V100W1A□	PM□-D2V100W1A□
Output Voltage	36V	48V	48V	V1: 12V, V2: 5V	V1: 24V, V2: 5V
Output Voltage Range	32.4-39.6V	45.6-52.8V	43.2-52.8V	V1: 10.8-13.2V	V1: 21.6-26.4V
Output Current	9.7A	3.3A	7.3A	V1: 7.0A, V2: 3.0A	V1: 3.5A, V2: 3.0A
Output Power	349.2W	158.4W	350W	V1: 84W, V2: 15W	V1: 84W, V2: 15W
Line Regulation	< 0.5%				
Load Regulation	< 1.0%	< 0.5 %	< 1.0%	V1: < 1.0%, V2: < 2.0%	V1: < 1.0%, V2: < 2.0%
PARD (20MHz)	< 240mVpp	< 200mVpp	< 240mVpp	V1: 120mVpp, V2: 80mVpp	V1: 120mVpp, V2: 80mVpp
Hold-up Time	16ms typ. @ 115Vac, 20ms typ. @ 230Vac	20ms typ. @ 115Vac, 24ms typ. @ 230Vac	16ms typ. @ 115Vac, 20ms typ. @ 230Vac	20ms typ. @ 115Vac, 25ms typ. @ 230Vac	
INPUT					
Phase Input	Single Phase				
Input Voltage Range	90-132Vac, 180-264Vac (Selectable by Switch)			88-132Vac, 176-264Vac (Selectable by Switch)	
Input Frequency	47-63Hz				
Input Current	7.0A typ. @ 115Vac, 4.0A typ. @ 230Vac	3.0A typ. @ 115Vac, 2.0A typ. @ 230Vac	7.0A typ. @ 115Vac, 4.0A typ. @ 230Vac	2.0A typ. @ 115Vac, 1.2A typ. @ 230Vac	2.0A typ. @ 115Vac, 1.2A typ. @ 230Vac
Efficiency ¹⁾ at 100% Load	87.5% typ. @ 230Vac	89.0% typ. @ 230Vac	87.5% typ. @ 230Vac	82.0% typ. @ 230Vac	84.0% @ 230Vac
Max Inrush Current (Cold Start)	40A typ. @ 115Vac, 60A typ. @ 230Vac	45A typ. @ 230Vac	40A typ. @ 115Vac, 60A typ. @ 230Vac	45A typ. @ 230Vac	
Power Factor	NA	Conform to EN 61000-3-2	NA	Conform to EN 61000-3-2	
Leakage Current	< 3.5mA @ 240Vac	< 0.5mA @ 240Vac	< 3.5mA @ 240Vac	< 0.25mA @ 240Vac	
MECHANICAL					
Case Cover / Chassis	Aluminium	SGCC / Aluminium	Aluminium	SGCC / Aluminium	
Dimensions (L x W x H)	215 x 115 x 50 mm (8.46" x 4.53" x 1.97")	178 x 97 x 38 mm (7.01" x 3.82" x 1.50")	215 x 115 x 50 mm (8.46" x 4.53" x 1.97")	178 x 97 x 38 mm (7.01" x 3.82" x 1.50")	178 x 97 x 38 mm (7.01" x 3.82" x 1.50")
Unit Weight	0.83 kg (1.83 lb)	0.48 kg (1.06 lb)	0.83 kg (1.83 lb)	0.45 kg (0.99 lb)	0.42 kg (0.93 lb)
Cooling System	Forced Air (Built-in Fan)	Convection	Forced Air (Built-in Fan)	Convection	
MTBF ²⁾	> 700,000 hrs	> 700,000 hrs	> 700,000 hrs	> 700,000 hrs	> 700,000 hrs
ENVIRONMENT					
Operating Temperature	-10°C to +70°C				
Storage Temperature	-25°C to +85°C				
Power De-rating	> 50°C (2.5% / °C)				
Operating Humidity	5 to 95% RH (Non-Condensing)				
Operating Altitude	0 to 5,000 m (0 to 16,400 ft)				

Dimensions Reference

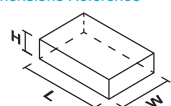

Notes

- 1) At 25°C ambient temperature by vertical mounting orientation.
- 2) MTBF as per Telcordia SR-332 (Confidence level: 90%, I/P: 100Vac, O/P: 100% load, Ta: 35°C). For PMT-36V350W1A□ and PMT-48V350W1A□ models, MTBF calculations does not include fan life time.
- 3) All parameters are specified at 25°C ambient temperature unless otherwise indicated.

PMT2 Panel Mount Power Supply

12V, 24V Output



PMT2

HIGHLIGHTS & FEATURES

- Household appliance approvals to IEC/EN 60335-1, IEC/EN 61558-1 and IEC/EN 61558-2-16
- Universal AC input voltage range (except 150W)
- No load power consumption
- Low profile design: 30mm height
- Over Voltage Category III
- Extreme low temperature cold start at -40°C
- High MTBF > 700,000 hrs per Telcordia SR-332

GENERAL SPECIFICATIONS

	NEW	NEW	NEW	NEW	NEW	NEW
OUTPUT	PMT-12V50W2BA	PMT-12V100W2BA	PMT-12V150W2BA	PMT-24V50W2BA	PMT-24V100W2BA	PMT-24V150W2BA
Output Voltage	12V	12V	12V	24V	24V	24V
Output Voltage Range	10.8-13.2V	10.8-13.2V	10.8-13.2V	21.6-26.4V	21.6-26.4V	21.6-26.4V
Output Current	4.2A	8.5A	12.5A	2.2A	4.5A	6.25A
Output Power	50.4W	102W	150W	52.8W	108W	150W
Line Regulation	PMT-□V50W2BA, PMT-□V100W2BA: < 0.5% typ. (@ 115Vac & 230Vac input, 100% load) PMT-□V150W2BA: < 0.5% typ. @ 100-132Vac, 170-264Vac (Selectable by Switch)					
Load Regulation	PMT-□V50W2BA, PMT-□V100W2BA: < 0.5% typ. (@ 115Vac & 230Vac input, 100% load) PMT-□V150W2BA: < 0.5% typ. @ 100-132Vac, 170-264Vac (Selectable by Switch)					
PARD (20MHz)	< 120mVpp @ 0°C to 50°C, < 360mVpp @ -30°C to 0°C			< 150mVpp @ 0°C to 50°C, < 450mVpp @ -30°C to 0°C		< 170mVpp @ 0°C to 50°C, < 510mVpp @ -30°C to 0°C
Hold-up Time	15ms typ. @ 115Vac, 70ms typ. @ 230Vac	5ms typ. @ 115Vac, 40ms typ. @ 230Vac	30ms typ. @ 115Vac & 230Vac	15ms typ. @ 115Vac, 70ms typ. @ 230Vac	5ms typ. @ 115Vac, 40ms typ. @ 230Vac	30ms typ. @ 115Vac & 230Vac
INPUT						
Phase Input	Single Phase					
Input Voltage Range	PMT-□V50W2BA, PMT-□V100W2BA: 90-264Vac PMT-□V150W2BA: 90-132Vac, 170-264Vac (Selectable by Switch)					
Input Frequency	47-63Hz					
Input Current	0.95A typ. @ 115Vac, 0.55A typ. @ 230Vac	1.9A typ. @ 115Vac, 1.2A typ. @ 230Vac	3.0A typ. @ 115Vac, 1.7A typ. @ 230Vac	0.95A typ. @ 115Vac, 0.55A typ. @ 230Vac	1.9A typ. @ 115Vac, 1.2A typ. @ 230Vac	3.0A typ. @ 115Vac, 1.7A typ. @ 230Vac
Efficiency ¹⁾ at 100% Load	86% typ. @ 230Vac	87% typ. @ 230Vac	85.8% typ. @ 230Vac	88.3% typ. @ 230Vac	89% typ. @ 230Vac	88.8% typ. @ 230Vac
Max Inrush Current (Cold Start)	40A typ. @ 230Vac	45A typ. @ 230Vac	30A typ. @ 230Vac	40A typ. @ 230Vac	45A typ. @ 230Vac	30A typ. @ 230Vac
Power Factor	NA					
Leakage Current (240Vac, 50Hz)	< 0.75mA					
MECHANICAL						
Case Cover / Chassis	SGCC / Aluminium					
Dimensions (L x W x H)	99 x 82 x 30 mm (3.90" x 3.23" x 1.18")	129 x 97 x 30 mm (5.08" x 3.82" x 1.18")	159 x 97 x 30 mm (6.26" x 3.82" x 1.18")	99 x 82 x 30 mm (3.90" x 3.23" x 1.18")	129 x 97 x 30 mm (5.08" x 3.82" x 1.18")	159 x 97 x 30 mm (6.26" x 3.82" x 1.18")
Unit Weight	0.18 kg (0.39 lb)	0.29 kg (0.63 lb)	0.35 kg (0.78 lb)	0.18 kg (0.39 lb)	0.29 kg (0.63 lb)	0.35 kg (0.78 lb)
Cooling System	Convection					
MTBF ²⁾	> 700,000 hrs	> 700,000 hrs	> 700,000 hrs	> 700,000 hrs	> 700,000 hrs	> 700,000 hrs
ENVIRONMENT						
Operating Temperature	-30°C to +70°C					
Storage Temperature	-25°C to +85°C					
Power De-rating	PMT-□V50W2BA, PMT-□V100W2BA: > 50°C (2% / °C) PMT-□V150W2BA: > 50°C (2% / °C), < -25°C (4% / °C) @ 100Vac					
Operating Humidity	5 to 95% RH (Non-Condensing)					
Operating Altitude	0 to 5,000 m (0 to 16,400 ft)					

Dimensions Reference

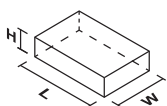

Notes

- 1) At 25°C ambient temperature by vertical mounting orientation.
- 2) MTBF as per Telcordia SR-332 (Confidence level: 90%, I/P: 230Vac, O/P: 100% load).
- 3) All parameters are specified at 25°C ambient temperature unless otherwise indicated.

PMC Panel Mount Power Supply

5V Output

PMC



HIGHLIGHTS & FEATURES

- Universal AC input voltage range
- Power will not de-rate for the entire input voltage range
- Full corrosion resistant aluminium casing (except PMC-05V015W1AA)
- Conforms to harmonic current IEC/EN 61000-3-2, Class A
- High MTBF > 700,000 hrs per Telcordia SR-332
- Safety approval according to IEC/EN/UL 60950-1 (ITE standard) and EMI to EN 55032, Class B

GENERAL SPECIFICATIONS

OUTPUT	PMC-05V015W1AA	PMC-05V035W1A□	PMC-05V050W1AA
Output Voltage	5V	5V	5V
Output Voltage Range	4.75-5.50V	4.75-5.50V	4.75-5.50V
Output Current	0-3.0A	0-7.0A	0-10.0A
Output Power	15W	35W	50W
Line Regulation	< 0.5% typ. (@ 85-264Vac input, 100% load)		
Load Regulation	< 1.0% typ. (@ 85-264Vac input, 0-100% load)		
PARD (20MHz)	< 70mVpp		
Hold-up Time	> 15ms @ 115Vac, > 80ms @ 230Vac		
INPUT			
Phase Input	Single Phase		
Input Voltage Range	85-264Vac (DC input range 125-375Vdc) ¹⁾		
Input Frequency	47-63Hz		
Input Current	< 0.32A @ 115Vac, < 0.22A @ 230Vac	< 0.90A @ 115Vac, < 0.80A @ 230Vac	< 1.10A @ 115Vac, < 0.70A @ 230Vac
Efficiency ²⁾ at 100% Load	> 79.0% @ 115Vac & 230Vac	> 78.0% @ 115Vac, > 79.0% @ 230Vac	> 79.0% @ 115Vac & 230Vac
Max Inrush Current (Cold Start)	< 30A @ 115Vac, < 65A @ 230Vac	< 30A @ 115Vac, < 60A @ 230Vac	< 30A @ 115Vac, < 65A @ 230Vac
Power Factor	Conform to EN 61000-3-2		
Leakage Current	< 1mA @ 240Vac		
MECHANICAL			
Case Cover / Chassis	SECC Steel	Aluminium	
Dimensions (L x W x H)	77 x 51 x 28 mm (3.03" x 2.01" x 1.10")	98 x 97 x 38 mm (3.86" x 3.82" x 1.50")	128 x 97 x 38 mm (5.04" x 3.82" x 1.50")
Unit Weight	0.16 kg (0.35 lb)	0.18 kg (0.40 lb)	0.26 kg (0.57 lb)
Cooling System	Convection		
MTBF ³⁾	> 700,000 hrs	> 700,000 hrs	> 700,000 hrs
ENVIRONMENT			
Operating Temperature	-10°C to +70°C		
Storage Temperature	-25°C to +85°C		
Power De-rating	> 60°C (2.5% / °C)	> 50°C (2.5% / °C)	
Operating Humidity	5 to 95% RH (Non-Condensing)		
Operating Altitude	0 to 3,000 m (0 to 9,840 ft)		

Dimensions Reference

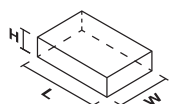

Notes

- 1) All models are certified for DC input except PMC-05V015W1AA which still fulfills the test conditions of this range. DC input safety approval can be obtained upon request.
- 2) At 25°C ambient temperature by vertical mounting orientation.
- 3) MTBF as per Telcordia SR-332 (Confidence level: 90%, I/P: 115Vac, O/P: 100% load) for vertical mounting orientation.
- 4) All parameters are specified at 25°C ambient temperature unless otherwise indicated.

PMC Panel Mount Power Supply

12V Output



PMC

HIGHLIGHTS & FEATURES

- Universal AC input voltage range
- Power will not de-rate for the entire input voltage range
- Full corrosion resistant aluminium casing
- Conforms to harmonic current IEC/EN 61000-3-2, Class A
- High MTBF > 700,000 hrs per Telcordia SR-332
- Safety approval according to IEC/EN/UL 60950-1 (ITE standard) and EMI to EN 55032, Class B
- Also available: IP20 connector

GENERAL SPECIFICATIONS

OUTPUT	PMC-12V035W1A□	PMC-12V050W1A□	PMC-12V060W1NA	PMC-12V100W1AA
Output Voltage	12V	12V	12V	12V
Output Voltage Range	11-14V	11-14V	12-14V	11-14V
Output Current	0-3.0A	0-4.17A	0-5.0A	0-8.33A
Output Power	35W	50W	60W	100W
Line Regulation	< 0.5% typ. (@ 85-264Vac input, 100% load)			
Load Regulation	< 1.0% typ. (@ 85-264Vac input, 0-100% load)			
PARD (20MHz)	< 100mVpp			
Hold-up Time	> 15ms @ 115Vac, > 80ms @ 230Vac			
INPUT				
Phase Input	Single Phase			
Input Voltage Range	85-264Vac (DC input range 125-375Vdc) ¹⁾			
Input Frequency	47-63Hz			
Input Current	< 0.75A @ 115Vac, < 0.50A @ 230Vac	< 1.10A @ 115Vac, < 0.70A @ 230Vac	< 1.35A @ 115Vac, < 0.90A @ 230Vac	< 2.00A @ 115Vac, < 1.10A @ 230Vac
Efficiency ²⁾ at 100% Load	> 85.0% @ 115Vac, > 86.0% @ 230Vac	> 84.0% @ 115Vac & 230Vac	> 86.0% @ 115Vac, > 87.0% @ 230Vac	> 84.0% @ 115Vac, > 86.0% @ 230Vac
Max Inrush Current (Cold Start)	< 30A @ 115Vac, < 60A @ 230Vac	< 30A @ 115Vac, < 65A @ 230Vac	< 50A @ 115Vac, < 100A @ 230Vac	< 60A @ 115Vac, < 130A @ 230Vac
Power Factor	Conform to EN 61000-3-2			
Leakage Current	< 1mA @ 240Vac			
MECHANICAL				
Case Cover / Chassis	Aluminium			
Dimensions (L x W x H)	98 x 97 x 38 mm (3.86" x 3.82" x 1.50")	128 x 97 x 38 mm (5.04" x 3.82" x 1.50")	128 x 97 x 38 mm (5.04" x 3.82" x 1.50")	158 x 97 x 38 mm (6.22" x 3.82" x 1.50")
Unit Weight	0.21 kg (0.46 lb)	0.26 kg (0.57 lb)	0.28 kg (0.62 lb)	0.45 kg (0.99 lb)
Cooling System	Convection			
MTBF ³⁾	> 700,000 hrs	> 700,000 hrs	> 700,000 hrs	> 700,000 hrs
ENVIRONMENT				
Operating Temperature	-10°C to +70°C		-20°C to +70°C	
Storage Temperature	-25°C to +85°C			
Power De-rating	> 50°C (2.5% / °C)		< -10°C (2% / °C), > 50°C (2.5% / °C)	
Operating Humidity	5 to 95% RH (Non-Condensing)			
Operating Altitude	0 to 3,000 m (0 to 9,840 ft)			

Dimensions Reference

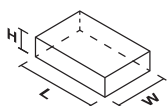

Notes

- 1) All models are certified for DC input.
- 2) At 25°C ambient temperature by vertical mounting orientation.
- 3) MTBF as per Telcordia SR-332 (Confidence level: 90%, I/P: 115Vac, O/P: 100% load) for vertical mounting orientation.
- 4) All parameters are specified at 25°C ambient temperature unless otherwise indicated.

12V Output



PMC

HIGHLIGHTS & FEATURES

- Universal AC input voltage range
- Power will not de-rate for the entire input voltage range
- Full corrosion resistant aluminium casing (except PMC-12V600W1BA)
- Conforms to harmonic current IEC/EN 61000-3-2, Class A
- High MTBF > 700,000 hrs per Telcordia SR-332
- Safety approval according to IEC/EN/UL 60950-1 (ITE standard) and EMI to EN 55032, Class B

GENERAL SPECIFICATIONS

		NEW
OUTPUT	PMC-12V150W1B□	PMC-12V600W1BA
Output Voltage	12V	12V
Output Voltage Range	11-14V	10.8-13.2V
Output Current	0-12.5A	0-50A
Output Power	150W	600W
Line Regulation	< 0.5% typ. (@ 85-264Vac input, 100% load)	< 48mV (@100-264Vac input, 100% load)
Load Regulation	< 1.0% typ. (@ 85-264Vac input, 0-100% load)	< 100mV (@100-264Vac input, 0-100% load)
PARD (20MHz)	< 100mVpp	< 240mVpp
Hold-up Time	> 30ms @ 115Vac & 230Vac (100% load)	> 20ms @ 115Vac & 230Vac (100% load)
INPUT		
Phase Input	Single Phase	
Input Voltage Range	85-264Vac (DC input range 125-375Vdc) ¹⁾	85-264Vac (DC input range 120-375Vdc) ¹⁾
Input Frequency	47-63Hz	
Input Current	< 1.70A @ 115Vac, < 1.00A @ 230Vac	< 6.5A @ 115Vac, < 3.2A @ 230Vac
Efficiency ²⁾ at 100% Load	> 87.0% @ 115Vac, > 88.0% @ 230Vac	> 84% @ 115Vac, > 87% @ 230Vac
Max Inrush Current (Cold Start)	< 60A @ 115Vac, < 120A @ 230Vac	< 20A @ 115Vac, < 40A @ 230Vac
Power Factor	> 0.99 @ 115Vac, > 0.90 @ 230Vac	> 0.98 @ 115Vac, > 0.95 @ 230Vac
Leakage Current	< 1mA @ 240Vac	
MECHANICAL		
Case Cover / Chassis	Aluminium	SECC Steel
Dimensions (L x W x H)	178 x 97 x 38 mm (7.01" x 3.82" x 1.50")	215 x 120 x 61 mm (8.46" x 4.72" x 2.4")
Unit Weight	0.54 kg (1.19 lb)	1.51 kg (3.33 lb)
Cooling System	Convection	Forced Air (Built-in Fan)
MTBF ³⁾	> 700,000 hrs	> 700,000 hrs
ENVIRONMENT		
Operating Temperature	-10°C to +70°C	-20°C to +70°C
Storage Temperature	-25°C to +85°C	-40°C to +85°C
Power De-rating	> 50°C (2.5% / °C)	> 50°C (2.5% / °C)
Operating Humidity	5 to 95% RH (Non-Condensing)	
Operating Altitude	0 to 3,000 m (0 to 9,840 ft)	

Dimensions Reference

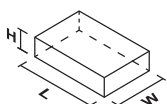

Notes

- 1) All models fulfill the test conditions for this range. DC input safety approval can be obtained upon request.
- 2) At 25°C ambient temperature by vertical mounting orientation.
- 3) MTBF as per Telcordia SR-332 (Confidence level: 90%, I/P: 115Vac, O/P: 100% load) for vertical mounting orientation. For PMC-12V600W1BA, MTBF calculations do not include fan life time.
- 4) All parameters are specified at 25°C ambient temperature unless otherwise indicated.

PMC Panel Mount Power Supply

24V Output



PMC

HIGHLIGHTS & FEATURES

- Universal AC input voltage range
- Power will not de-rate for the entire input voltage range
- Full corrosion resistant aluminium casing
- Conforms to harmonic current IEC/EN 61000-3-2, Class A
- High MTBF > 700,000 hrs per Telcordia SR-332
- Safety approval according to IEC/EN/UL 60950-1 (ITE standard) and EMI to EN 55032, Class B
- Also available: IP20 connector

GENERAL SPECIFICATIONS

OUTPUT	PMC-24V035W1A□	PMC-24V050W1A□	PMC-24V075W1A□	PMC-24V100W1A□	PMC-24V150W1A□
Output Voltage	24V	24V	24V	24V	24V
Output Voltage Range	22-28V	22-28V	22-28V	22-28V	22-28V
Output Current	0-1.46A	0-2.1A	0-3.12A	0-4.17A	0-6.25A
Output Power	35W	50W	75W	100W	150W
Line Regulation	< 0.5% typ. (@ 85-264Vac input, 100% load)				
Load Regulation	< 1.0% typ. (@ 85-264Vac input, 0-100% load)				
PARD (20MHz)	< 150mVpp		< 100mVpp	< 150mVpp	< 100mVpp
Hold-up Time	> 15ms @ 115Vac, > 80ms @ 230Vac	> 15ms @ 115Vac, > 90ms @ 230Vac			> 15ms @ 115Vac, > 80ms @ 230Vac
INPUT					
Phase Input	Single Phase				
Input Voltage Range	85-264Vac (DC input range 125-375Vdc) ¹⁾				
Input Frequency	47-63Hz				
Input Current	< 0.75A @ 115Vac, < 0.50A @ 230Vac	< 1.10A @ 115Vac, < 0.70A @ 230Vac	< 1.50A @ 115Vac, < 1.00A @ 230Vac	< 2.00A @ 115Vac, < 1.10A @ 230Vac	< 3.10A @ 115Vac, < 2.00A @ 230Vac
Efficiency ²⁾ at 100% Load	> 85.0% @ 115Vac & 230Vac	> 86.0% @ 115Vac & 230Vac			> 87.0% @ 115Vac, > 88.0% @ 230Vac
Max Inrush Current (Cold Start)	< 30A @ 115Vac, < 60A @ 230Vac		< 40A @ 115Vac, < 80A @ 230Vac	< 50A @ 115Vac, < 100A @ 230Vac	< 60A @ 115Vac, < 120A @ 230Vac
Power Factor	Conform to EN 61000-3-2				NA
Leakage Current	< 1mA @ 240Vac				
MECHANICAL					
Case Cover / Chassis	Aluminium				
Dimensions (L x W x H)	128 x 97 x 38 mm (5.04" x 3.82" x 1.50")	128 x 97 x 38 mm (5.04" x 3.82" x 1.50")	128 x 97 x 38 mm (5.04" x 3.82" x 1.50")	158 x 97 x 38 mm (6.22" x 3.82" x 1.50")	178 x 97 x 38 mm (7.01" x 3.82" x 1.50")
Unit Weight	0.24 kg (0.53 lb)	0.26 kg (0.57 lb)	0.30 kg (0.66 lb)	0.41 kg (0.90 lb)	0.48 kg (1.06 lb)
Cooling System	Convection				
MTBF ³⁾	> 700,000 hrs	> 700,000 hrs	> 700,000 hrs	> 700,000 hrs	> 700,000 hrs
ENVIRONMENT					
Operating Temperature	-10°C to +70°C				
Storage Temperature	-25°C to +85°C				
Power De-rating	> 50°C (2.5% / °C)				
Operating Humidity	5 to 95% RH (Non-Condensing)				
Operating Altitude	0 to 3,000 m (0 to 9,840 ft)				0 to 5,000 m (0 to 16,400 ft)

Dimensions Reference

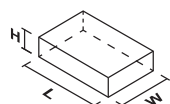

Notes

- 1) All models are certified for DC input.
- 2) At 25°C ambient temperature by vertical mounting orientation.
- 3) MTBF as per Telcordia SR-332 (Confidence level: 90%, I/P: 115Vac, O/P: 100% load) for vertical mounting orientation.
- 4) All parameters are specified at 25°C ambient temperature unless otherwise indicated.

24V Output



PMC

HIGHLIGHTS & FEATURES

- Universal AC input voltage range
- Power will not de-rate for the entire input voltage range
- Full corrosion resistant aluminium casing (except PMC-24V600W1BA)
- Conforms to harmonic current IEC/EN 61000-3-2, Class A
- High MTBF > 700,000 hrs per Telcordia SR-332
- Safety approval according to IEC/EN/UL 60950-1 (ITE standard) and EMI to EN 55032, Class B
- Also available: IP20 and Front Face connectors

GENERAL SPECIFICATIONS

OUTPUT	PMC-24V150W2AA	PMC-24V150W1B□	PMC-24V300W1BA	PMC-24V600W1BA	PMC-DSPV100W1A
Output Voltage	24V	24V	V1: 24V, V2 SB: 12V	24V	V1: 24V, V2: 5V
Output Voltage Range	22-28V	22-28V	V1: 22-28V	21.6-26.4V	V1: 22.8-26.4V
Output Current	0-6.25A	0-6.25A	V1: 12.5A (0-12.5A) V2 SB: 0.5A (0-0.5A)	0-25.0A (50.0A for 5s)	V1: 2.7A (0.3-4.0A) V2: 7.0A (0.8-7.0A)
Output Power	150W	150W	300W	600W (1,200W for 5s)	100W
Line Regulation	< 0.5% typ. (@ 170-264Vac input, 100% load)	< 0.5% typ. (@ 85-264Vac input, 100% load)	< 0.5% typ. (@ 85-264Vac input, 100% load)		
Load Regulation	< 1.0% typ. (@ 170-264Vac input, 0-100% load)	< 1.0% typ. (@ 85-264Vac input, 0-100% load)	< 1.0% typ. (@ 85-264Vac input, 0-100% load)		
PARD (20MHz)	< 100mVpp		V1: < 100mVpp, V2: < 200mVpp	< 180mVpp	V1: < 200mVpp, V2: < 80mVpp
Hold-up Time	> 20ms @ 230Vac	> 30ms @ 115Vac & 230Vac	> 15ms @ nominal input, 100% load	> 20ms @ 115Vac & 230Vac	> 15ms @ 115Vac, > 80ms @ 230Vac
INPUT					
Phase Input	Single Phase				
Input Voltage Range	180-264Vac (DC input range 220-375Vdc) ¹⁾	85-264Vac (DC input range 125-375Vdc) ¹⁾		85-264Vac (DC input range 120-370Vdc) ¹⁾	85-264Vac (DC input range 125-375Vdc) ¹⁾
Input Frequency	47-63Hz				
Input Current	< 1.6A @ 230Vac	< 1.7A @ 115Vac, < 1.0A @ 230Vac	< 4.0A @ 115Vac, < 2.0A @ 230Vac	< 6.5A @ 115Vac, < 3.2A @ 230Vac	< 2.0A @ 115Vac, < 1.1A @ 230Vac
Efficiency ²⁾ at 100% Load	> 87.0% @ 230Vac	> 89.0% @ 115Vac, > 91.0% @ 230Vac	> 86.0% @ 115Vac, > 88.0% @ 230Vac	> 86.0% @ 115Vac, > 89.0% @ 230Vac	> 84.0% @ 115Vac, > 86.0% @ 230Vac
Max Inrush Current (Cold Start)	< 120A @ 230Vac	< 60A @ 115Vac, < 120A @ 230Vac	< 35A @ 115Vac, < 70A @ 230Vac	< 20A @ 115Vac, < 40A @ 230Vac	< 50A @ 115Vac, < 100A @ 230Vac
Power Factor	Conform to EN 61000-3-2	> 0.99 @ 115Vac, > 0.90 @ 230Vac	> 0.99 @ 115Vac, > 0.97 @ 230Vac	> 0.99 @ 115Vac, > 0.94 @ 230Vac	Conform to EN 61000-3-2
Leakage Current	< 1mA @ 240Vac		< 1.5mA @ 240Vac		< 1mA @ 240Vac
MECHANICAL					
Case Cover / Chassis	Aluminium			SECC Steel	Aluminium
Dimensions (L x W x H)	178 x 97 x 38 mm (7.01" x 3.82" x 1.50")	178 x 97 x 38 mm (7.01" x 3.82" x 1.50")	199 x 105 x 41 mm (7.83" x 4.13" x 1.61")	215 x 120 x 61 mm (8.46" x 4.72" x 2.40")	178 x 97 x 38 mm (7.01" x 3.82" x 1.50")
Unit Weight	0.50 kg (1.10 lb)	0.54 kg (1.19 lb)	0.82 kg (1.81 lb)	1.60 kg (3.53 lb)	0.52 kg (1.15 lb)
Cooling System	Convection			Forced Air (Built-in Fan)	Convection
MTBF ³⁾	> 700,000 hrs	> 700,000 hrs	> 700,000 hrs	> 300,000 hrs	> 700,000 hrs
ENVIRONMENT					
Operating Temperature	-10°C to +70°C			-20°C to +70°C	-10°C to +70°C
Storage Temperature	-25°C to +85°C			-20°C to +75°C	-25°C to +85°C
Power De-rating	> 50°C (2.5% / °C)				
Operating Humidity	5 to 95% RH (Non-Condensing)				
Operating Altitude	0 to 3,000 m (0 to 9,840 ft)	0 to 5,000 m (0 to 16,400 ft)	0 to 3,000 m (0 to 9,840 ft)		

Dimensions Reference

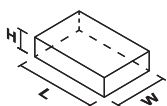

Notes

- 1) All models fulfill the test conditions for this range. DC input safety approval can be obtained upon request. While PMC-24V150W2AA and PMC-DSPV100W1A are also certified for DC input.
- 2) At 25°C ambient temperature by vertical mounting orientation.
- 3) MTBF as per Telcordia SR-332 (Confidence level: 90%, I/P: 115Vac, O/P: 100% load) for vertical mounting orientation. For PMC-24V300W1BA and PMC-24V600W1BA models, MTBF calculations do not include fan life time.
- 4) All parameters are specified at 25°C ambient temperature unless otherwise indicated.

PMC Panel Mount Power Supply

48V Output



PMC

HIGHLIGHTS & FEATURES

- Universal AC input voltage range
- Power will not de-rate for the entire input voltage range
- Full corrosion resistant aluminium casing (except PMC-48V600W1BA)
- Conforms to harmonic current IEC/EN 61000-3-2, Class A
- High MTBF > 700,000 hrs per Telcordia SR-332
- Safety approval according to IEC/EN/UL 60950-1 (ITE standard) and EMI to EN 55032, Class B

GENERAL SPECIFICATIONS

	NEW	
	PMC-48V150W1BA	PMC-48V600W1BA
OUTPUT		
Output Voltage	48V	48V
Output Voltage Range	44-53V	43.2-52.8V
Output Current	0-3.125A	0-12.5A
Output Power	150W	600W
Line Regulation	< 0.5% typ. (@ 85-264Vac input, 100% load)	< 192mV (@100-264Vac input, 100% load)
Load Regulation	< 1.0% typ. (@ 85-264Vac input, 0-100% load)	< 300mV (@100-264Vac input, 0-100% load)
PARD (20MHz)	< 200mVpp	< 360mVpp
Hold-up Time	> 30ms @ 115Vac & 230Vac (100% load)	> 20ms @ 115Vac & 230Vac (100% load)
INPUT		
Phase Input	Single Phase	
Input Voltage Range	85-264Vac (DC input range 125-375Vdc) ¹⁾	85-264Vac (DC input range 120-370Vdc) ¹⁾
Input Frequency	47-63Hz	
Input Current	< 1.7A @ 115Vac, < 1.0A @ 230Vac	< 6.5A @ 115Vac, < 3.2A @ 230Vac
Efficiency ²⁾ at 100% Load	> 89.0% @ 115Vac, > 91.0% @ 230Vac	> 87.0% @ 115Vac, > 90.0% @ 230Vac
Max Inrush Current (Cold Start)	< 20A @ 115Vac, < 40A @ 230Vac	< 20A @ 115Vac, < 40A @ 230Vac
Power Factor	> 0.99 @ 115Vac, > 0.92 @ 230Vac	> 0.98 @ 115Vac, > 0.95 @ 230Vac
Leakage Current	< 1.5mA @ 240Vac	< 1mA @ 240Vac
MECHANICAL		
Case Cover / Chassis	Aluminium	SECC Steel
Dimensions (L x W x H)	178 x 97 x 38 mm (7.01" x 3.82" x 1.50")	215 x 120 x 61 mm (8.46" x 4.72" x 2.4")
Unit Weight	0.53 kg (1.17 lb)	1.54 kg (3.40 lb)
Cooling System	Convection	Forced Air (Built-in Fan)
MTBF ³⁾	> 700,000 hrs	> 700,000 hrs
ENVIRONMENT		
Operating Temperature	-10°C to +70°C	-20°C to +70°C
Storage Temperature	-25°C to +85°C	-40°C to +85°C
Power De-rating	> 50°C (2.5% / °C)	
Operating Humidity	5 to 95% RH (Non-Condensing)	
Operating Altitude	0 to 5,000 m (0 to 16,400 ft)	0 to 3,000 m (0 to 9,840 ft)

Dimensions Reference

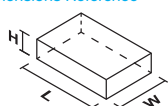

Notes

- 1) All models fulfill the test conditions for DC input. DC input safety approval can be obtained upon request.
- 2) At 25°C ambient temperature by vertical mounting orientation.
- 3) MTBF as per Telcordia SR-332 (Confidence level: 90%, I/P: 115Vac, O/P: 100% load) for vertical mounting orientation. For PMC-48V600W1BA, MTBF calculations do not include fan life time.
- 4) All parameters are specified at 25°C ambient temperature unless otherwise indicated.

PMH Panel Mount Power Supply

24V Output

PMH



AR

HIGHLIGHTS & FEATURES

- Household appliance approvals to IEC/EN 60335-1, IEC/EN 61558-1 and IEC/EN 61558-2-16
- Universal AC input voltage range
- Full power from -20°C to +50°C operation
- Full corrosion resistant aluminium casing
- High MTBF > 700,000 hrs per Telcordia SR-332
- Also available: IP20, Front Face and Harness connectors

GENERAL SPECIFICATIONS

OUTPUT	PMH-24V50WCA□	PMH-24V100WCA□	PMH-24V100WCC□	PMH-24V100WCN□
Output Voltage	24V	24V	24V	24V
Output Voltage Range	22-28V	22-28V	22-28V	22-24V
Output Current	0-2.1A	0-4.16A	0-4.16A	0-3.8A
Output Power	50W	100W	100W	91.2W
Line Regulation	< 0.5% typ. (@ 85-264Vac input, 100% load)			< 1.0% typ. (@ 85-264Vac input, 100% load)
Load Regulation	< 0.5% typ. (@ 85-264Vac input, 0-100% load)	< 1.0% typ. (@ 85-264Vac input, 0-100% load)		< 2.0% typ. (@ 85-264Vac input, 0-100% load)
PARD (20MHz) ¹⁾	< 100mVpp @ -20°C to 70°C < 150mVpp @ < -20°C to -30°C	< 100mVpp		
Hold-up Time	> 15ms @ 115Vac, > 90ms @ 230Vac (100% load)	> 15ms @ 115Vac, > 100ms @ 230Vac (100% load)		
INPUT				
Phase Input	Single Phase			
Input Voltage Range	85-264Vac (DC input range 120-375Vdc) ²⁾			
Input Frequency	47-63Hz			
Input Current	< 0.94A @ 115Vac, < 0.59A @ 230Vac	< 1.90A @ 115Vac, < 1.10A @ 230Vac		< 1.90A @ 115Vac, < 1.00A @ 230Vac
Efficiency ³⁾ at 100% Load	> 87.0% @ 115Vac, > 88.0% @ 230Vac	> 87.0% @ 115Vac, > 89.0% @ 230Vac		> 87.0% @ 115Vac, > 88.5% @ 230Vac
Max Inrush Current (Cold Start)	< 35A @ 115Vac, < 70A @ 230Vac	< 50A @ 115Vac, < 100A @ 230Vac		
Power Factor	Conform to EN 61000-3-2			
Leakage Current	< 0.5mA @ 264Vac	< 1.2mA @ 240Vac	< 0.5mA @ 240Vac	< 0.75mA @ 264Vac
MECHANICAL				
Case Cover / Chassis	Aluminium			
Dimensions (L x W x H)	98 x 97 x 38 mm (3.86" x 3.82" x 1.50")	158 x 97 x 38 mm (6.22" x 3.82" x 1.50")	158 x 97 x 38 mm (6.22" x 3.82" x 1.50")	158 x 97 x 38 mm (6.22" x 3.82" x 1.50")
Unit Weight	0.21 kg (0.46 lb)	0.43 kg (0.95 lb)	0.43 kg (0.95 lb)	0.43 kg (0.95 lb)
Cooling System	Convection			
MTBF ⁴⁾	> 700,000 hrs	> 700,000 hrs	> 700,000 hrs	> 700,000 hrs
ENVIRONMENT				
Operating Temperature	-30°C to +70°C			
Storage Temperature	-30°C to +85°C			
Power De-rating	< -20°C (2% / °C), > 50°C (2.5% / °C)			
Operating Humidity	5 to 95% RH (Non-Condensing)			
Operating Altitude	0 to 5,000 m (0 to 16,400 ft)			

Dimensions Reference

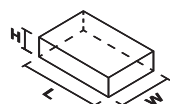

Notes

- 1) PARD is measured with an AC coupling mode, 5cm wires, and in parallel with 0.1µF ceramic capacitor & 47µF electrolytic capacitor.
- 2) All models are certified for DC input.
- 3) At 25°C ambient temperature by vertical mounting orientation.
- 4) MTBF as per Telcordia SR-332 (Confidence level: 90%, I/P: 115Vac, O/P: 100% load) for vertical mounting orientation.
- 5) All parameters are specified at 25°C ambient temperature unless otherwise indicated.

PMH Panel Mount Power Supply

24V Output



PMH

HIGHLIGHTS & FEATURES

- Household appliance approvals to IEC/EN 60335-1, IEC/EN 61558-1 and IEC/EN 61558-2-16
- Universal AC input voltage range
- Full power from -20°C to +50°C operation (except PMH-24V200WCB□)
- Full corrosion resistant aluminium casing
- High MTBF > 700,000 hrs per Telcordia SR-332
- Also available: IP20, Front Face and Harness connectors

GENERAL SPECIFICATIONS

OUTPUT	PMH-24V150WCB□	PMH-24V150WCD□	PMH-24V200WCB□
Output Voltage	24V	24V	24V
Output Voltage Range	22-28V	22-28V	22-28V
Output Current	0-6.25A	0-6.25A	0-8.33A
Output Power	150W	150W	200W
Line Regulation	< 0.5% typ. (@ 85-264Vac input, 100% load)		
Load Regulation	< 0.5% typ. (@ 85-264Vac input, 0-100% load)		
PARD (20MHz) ¹⁾	< 100mVpp		< 100mVpp @ -20°C to 70°C < 240mVpp @ < -20°C to -30°C
Hold-up Time	> 40ms @ 115Vac, > 50ms @ 230Vac (100% load)		> 20ms @ 115Vac & 230Vac (100% load)
INPUT			
Phase Input	Single Phase		
Input Voltage Range	85-264Vac (DC input range 120-375Vdc) ²⁾		
Input Frequency	47-63Hz		
Input Current	< 1.6A @ 115Vac, < 0.9A @ 230Vac		< 2.2A @ 115Vac, < 1.2A @ 230Vac
Efficiency ³⁾ at 100% Load	> 89.0% @ 115Vac, > 90.5% @ 230Vac		> 89.5% @ 115Vac, > 91.5% @ 230Vac
Max Inrush Current (Cold Start)	< 30A @ 115Vac, < 60A @ 230Vac		< 60A @ 115Vac, < 120A @ 230Vac
Power Factor	> 0.98 @ 115Vac, > 0.89 @ 230Vac		> 0.98 @ 115Vac, > 0.92 @ 230Vac
Leakage Current	< 1.2mA @ 240Vac	< 0.75mA @ 240Vac	< 1mA @ 264Vac
MECHANICAL			
Case Cover / Chassis	Aluminium		
Dimensions (L x W x H)	178 x 97 x 38 mm (7.01" x 3.82" x 1.50")	178 x 97 x 38 mm (7.01" x 3.82" x 1.50")	190 x 97 x 38 mm (7.48" x 3.82" x 1.50")
Unit Weight	0.56 kg (1.23 lb)	0.56 kg (1.23 lb)	0.61 kg (1.34 lb)
Cooling System	Convection		
MTBF ⁴⁾	> 700,000 hrs	> 700,000 hrs	> 700,000 hrs
ENVIRONMENT			
Operating Temperature	-30°C to +70°C		
Storage Temperature	-30°C to +85°C		
Power De-rating	< -20°C (2% / °C), > 50°C (2.5% / °C)		< -20°C (2% / °C), > 45°C (2% / °C)
Operating Humidity	5 to 95% RH (Non-Condensing)		
Operating Altitude	0 to 5,000 m (0 to 16,400 ft)		

Dimensions Reference

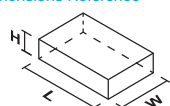

Notes

- 1) PARD is measured with an AC coupling mode, 5cm wires, and in parallel with 0.1µF ceramic capacitor & 47µF electrolytic capacitor.
- 2) All models fulfill the test conditions of this range. DC input safety approval can be obtained upon request.
- 3) At 25°C ambient temperature by vertical mounting orientation.
- 4) MTBF as per Telcordia SR-332 (Confidence level: 90%, I/P: 115Vac, O/P: 100% load) for vertical mounting orientation.
- 5) All parameters are specified at 25°C ambient temperature unless otherwise indicated.

PMH - Low Profile



HIGHLIGHTS & FEATURES

- Household appliance approvals for pollution degree 3 to IEC/EN 60335-1, IEC/EN 61558-1 and IEC/EN 61558-2-16
- Universal AC input voltage range
- Full corrosion resistant aluminium casing
- Low profile design for 1U installation
- Low earth leakage current < 0.75mA
- No load input power consumption < 0.5W @ 230Vac
- Full power from -25°C to +50°C operation @ 5,000 m or 16,400 ft altitude
- Also available: IP20, Front Face and Harness connectors

GENERAL SPECIFICATIONS

OUTPUT	PMH-12V100WCL□	PMH-24V100WCL□	PMH-24V100WCM□	PMH-24V150WCL□
Output Voltage	12V	24V	24V	24V
Output Voltage Range	12-14V	24-28V	22-24V	24-28V
Output Current	0-8.5A	0-4.5A	0-3.8A	0-6.5A
Output Power	102W	108W	91.2W	156W
Line Regulation	< 1.0% typ. (@ 100-264Vac input, 100% load)	< 0.5% typ. (@ 100-264Vac input, 100% load)		
Load Regulation	< 2.0% typ. (@ 100-264Vac input, 0-100% load)	< 1.0% typ. (@ 100-264Vac input, 0-100% load)		< 0.5% typ. (@ 100-264Vac input, 0-100% load)
PARD (20MHz) ¹⁾	< 120mVpp	< 150mVpp		< 200mVpp
Hold-up Time	> 5ms @ 115Vac, > 50ms @ 230Vac (100% load)	> 10ms @ 115Vac, > 50ms @ 230Vac (100% load)		
INPUT				
Phase Input	Single Phase			
Input Voltage Range	85-264Vac (DC input range 120-375Vdc) ²⁾			
Input Frequency	47-63Hz			
Input Current	< 1.9A @ 115Vac, < 1.2A @ 230Vac			< 2.8A @ 115Vac, < 1.6A @ 230Vac
Efficiency ³⁾ at 100% Load	> 83.0% @ 115Vac, > 85.0% @ 230Vac	> 86.0% @ 115Vac, > 88.0% @ 230Vac		> 87.0% @ 115Vac, > 89.0% @ 230Vac
Max Inrush Current (Cold Start)	< 30A @ 115Vac, < 60A @ 230Vac	< 25A @ 115Vac, < 50A @ 230Vac		< 40A @ 115Vac, < 80A @ 230Vac
Power Factor	Conform to EN 61000-3-2			
Leakage Current	< 0.75mA @ 240Vac			
MECHANICAL				
Case Cover / Chassis	Aluminium			
Dimensions (L x W x H)	129 x 97 x 30 mm (5.08" x 3.82" x 1.18")	129 x 97 x 30 mm (5.08" x 3.82" x 1.18")	129 x 97 x 30 mm (5.08" x 3.82" x 1.18")	159 x 97 x 30 mm (6.26" x 3.82" x 1.18")
Unit Weight	0.31 kg (0.68 lb)	0.31 kg (0.68 lb)	0.31 kg (0.68 lb)	0.41 kg (0.90 lb)
Cooling System	Convection			
MTBF ⁴⁾	> 700,000 hrs	> 700,000 hrs	> 700,000 hrs	> 700,000 hrs
ENVIRONMENT				
Operating Temperature	-30°C to +70°C			
Storage Temperature	-40°C to +85°C			
Power De-rating	120Vac: < -25°C (5% / °C) 120Vac and 240Vac: > 50°C (2.0% / °C)			
Operating Humidity	5 to 95% RH (Non-Condensing)			
Operating Altitude	0 to 5,000 m (0 to 16,400 ft)			

Dimensions Reference

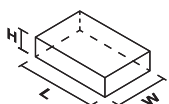

Notes

- 1) PARD is measured with an AC coupling mode, 5cm wires, and in parallel with 0.1µF ceramic capacitor & 47µF electrolytic capacitor.
- 2) All models fulfill the test conditions of this range. DC input safety approval can be obtained upon request.
- 3) At 25°C ambient temperature by vertical mounting orientation.
- 4) MTBF as per Telcordia SR-332 (Confidence level: 90%, I/P: 115Vac, O/P: 100% load) for vertical mounting orientation.
- 5) All parameters are specified at 25°C ambient temperature unless otherwise indicated.

PMF Panel Mount Power Supply

4.2V, 5V, 24V Output



PMF

HIGHLIGHTS & FEATURES

- Universal AC input voltage range
- Built-in active PFC and automatic fan speed control
- Full corrosion resistant aluminium casing
- Conforms to harmonic current IEC/EN 61000-3-2, Class D
- Remote ON/OFF is available as an option
- Short Circuit / Overvoltage / Overcurrent / Over Temperature Protections

GENERAL SPECIFICATIONS

OUTPUT	PMF-4V320WC□□	PMF-5V320WC□□	PMF-24V200WC□□	PMF-24V240WC□□	PMF-24V320WC□□
Output Voltage	4.2V	5V	24V	24V	24V
Output Voltage Range	3.78-4.62V	4.50-5.50V	21.6-26.4V	21.6-26.4V	21.6-26.4V
Output Current	55.0A	55.0A	8.4A	10.0A	13.3A
Output Power	231W	275W	201.6W	240W	320W
Line Regulation	< 0.5%				
Load Regulation	< 1.5%	< 1.0%	< 0.5%		< 1%
PARD (20MHz)	< 150mVpp				
Hold-up Time	16ms typ. @ 115Vac & 230Vac		20ms typ. @ 115Vac & 230Vac		
INPUT					
Phase Input	Single Phase				
Input Voltage Range	85-264Vac				
Input Frequency	47-63Hz				
Input Current	5.0A typ. @ 115Vac, 2.5A typ. @ 230Vac	5.0A typ. @ 115Vac, 2.5A typ. @ 230Vac	3.5A typ. @ 115Vac, 1.7A typ. @ 230Vac	3.6A typ. @ 115Vac, 1.8A typ. @ 230Vac	5.0A typ. @ 115Vac, 2.5A typ. @ 230Vac
Efficiency ¹⁾ at 100% Load	76.5% typ. @ 230Vac	78.5% typ. @ 230Vac	87.0% typ. @ 230Vac		
Max Inrush Current (Cold Start)	20A typ. @ 115Vac, 40A typ. @ 230Vac		30A typ. @ 115Vac, 50A typ. @ 230Vac	30A typ. @ 115Vac, 60A typ. @ 230Vac	20A typ. @ 115Vac, 40A typ. @ 230Vac
Power Factor	0.97 typ. @ 115Vac, 0.94 typ. @ 230Vac	0.98 typ. @ 115Vac, 0.95 typ. @ 230Vac	0.98 typ. @ 115Vac, 0.95 typ. @ 230Vac	0.99 typ. @ 115Vac, 0.95 typ. @ 230Vac	0.98 typ. @ 115Vac, 0.95 typ. @ 230Vac
Leakage Current	< 1mA @ 240Vac		< 0.5mA @ 240Vac		< 1mA @ 240Vac
MECHANICAL					
Case Cover / Chassis	Aluminium				
Dimensions (L x W x H)	215 x 115 x 50 mm (8.46" x 4.53" x 1.97")	215 x 115 x 50 mm (8.46" x 4.53" x 1.97")	190 x 93 x 50 mm (7.48" x 3.66" x 1.97")	190 x 93 x 50 mm (7.48" x 3.66" x 1.97")	215 x 115 x 50 mm (8.46" x 4.53" x 1.97")
Unit Weight	0.86 kg (1.90 lb)	0.86 kg (1.90 lb)	0.66 kg (1.46 lb)	0.66 kg (1.46 lb)	0.84 kg (1.85 lb)
Cooling System	Forced Air (Built-in Fan)				
MTBF ²⁾	> 700,000 hrs	> 700,000 hrs	> 700,000 hrs	> 700,000 hrs	> 700,000 hrs
ENVIRONMENT					
Operating Temperature	-10°C to +70°C				
Storage Temperature	-20°C to +85°C				
Power De-rating	> 55°C (3.33% / °C)		> 50°C (2.5% / °C)		
Operating Humidity	5 to 95% RH (Non-Condensing)				
Operating Altitude	0 to 5,000 m (0 to 16,400 ft)				

Dimensions Reference

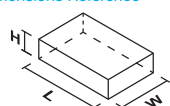

Notes

- 1) At 25°C ambient temperature by vertical mounting orientation.
- 2) MTBF as per Telcordia SR-332 (Confidence level: 90%, I/P: 100Vac, O/P: 100% load, Ta: 35°C). MTBF calculations do not include fan life time.
- 3) All parameters are specified at 25°C ambient temperature unless otherwise indicated.

PMR Panel Mount Power Supply

4.2V Output



PMR

HIGHLIGHTS & FEATURES

- Universal AC input voltage range
- Full corrosion resistant aluminium casing
- Built-in active PFC and conforms to harmonic current IEC/EN 61000-3-2, Class A and Class D
- Low profile design for 1U installation
- Built-in DC OK relay contact and redundancy operation (PMR-4V320WDBA and PMR-4V320WDCA)

GENERAL SPECIFICATIONS

OUTPUT	PMR-4V320WCDA	PMR-4V320WDAA	PMR-4V320WDGA	PMR-4V320WDBA	PMR-4V320WDCA
Output Voltage	4.2V	4.2V	4.2V	4.2V	4.2V
Output Voltage Range	3.78-4.62V	3.78-4.62V	3.78-4.62V	3.99-4.51V (No potentiometer)	3.99-4.51V (No potentiometer)
Output Current	60.0A	60.0A	60.0A	60.0A	60.0A
Output Power	252W	252W	252W	252W	252W
Line Regulation	< 0.5%				
Load Regulation	< 1.0%			NA	
PARD (20MHz)	< 150mVpp				
Hold-up Time	8ms typ.				
INPUT					
Phase Input	Single Phase				
Input Voltage Range	88-264Vac				
Input Frequency	47-63Hz				
Input Current	3.0A typ. @ 115Vac, 1.5A typ. @ 230Vac		4.5A typ. @ 115Vac, 2.5A typ. @ 230Vac		
Efficiency ¹⁾ at 100% Load	80.5% typ. @ 115Vac, 83.5% typ. @ 230Vac		84.5% typ. @ 115Vac, 86.5% typ. @ 230Vac		84.0% typ. @ 115Vac, 86.0% typ. @ 230Vac
Max Inrush Current (Cold Start)	20A typ. @ 115Vac, 40A typ. @ 230Vac				
Power Factor	0.98 typ. @ 115Vac, 0.95 typ. @ 230Vac				
Leakage Current	< 0.5mA @ 240Vac		< 1mA @ 240Vac		
MECHANICAL					
Case Cover / Chassis	Aluminium				
Dimensions (L x W x H)	215 x 115 x 30 mm (8.46" x 4.53" x 1.18")	215 x 115 x 30 mm (8.46" x 4.53" x 1.18")	215 x 115 x 30 mm (8.46" x 4.53" x 1.18")	215 x 115 x 30 mm (8.46" x 4.53" x 1.18")	215 x 115 x 30 mm (8.46" x 4.53" x 1.18")
Unit Weight	0.76 kg (1.68 lb)	0.86 kg (1.90 lb)	0.86 kg (1.90 lb)	0.86 kg (1.90 lb)	0.86 kg (1.90 lb)
Cooling System	Forced Air (Built-in Fan)	Convection			
MTBF ²⁾	> 700,000 hrs	> 700,000 hrs	> 700,000 hrs	> 700,000 hrs	> 700,000 hrs
ENVIRONMENT					
Operating Temperature	-10°C to +70°C		-20°C to +70°C		
Storage Temperature	-40°C to +85°C				
Power De-rating	> 50°C (2.5% / °C)		> 40°C (1% / °C), > 50°C (1.5% / °C)		
Operating Humidity	5 to 95% RH (Non-Condensing)				
Operating Altitude	0 to 5,000 m (0 to 16,400 ft)				

Dimensions Reference

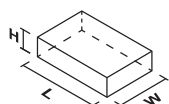

Notes

- 1) At 25°C ambient temperature by vertical mounting orientation.
- 2) MTBF as per Telcordia SR-332 (Confidence level: 90%, I/P: 100Vac, O/P: 100% load, Ta: 35°C). For PMR-4V320WCDA, MTBF calculation does not include fan life time.
- 3) All parameters are specified at 25°C ambient temperature unless otherwise indicated.

PMR Panel Mount Power Supply

5V Output



PMR

HIGHLIGHTS & FEATURES

- Universal AC input voltage range
- Full corrosion resistant aluminium casing
- Built-in active PFC and conforms to harmonic current IEC/EN 61000-3-2, Class A and Class D
- Low profile design for 1U installation
- Built-in DC OK relay contact and redundancy operation (PMR-5V320WDBA and PMR-5V320WDCA)

GENERAL SPECIFICATIONS

OUTPUT	PMR-5V320WC□A	PMR-5V320WDAA	PMR-5V320WDGA	PMR-5V320WDBA	PMR-5V320WDCA
Output Voltage	5V	5V	5V	5V	5V
Output Voltage Range	4.50-5.50V	4.50-5.50V	4.50V-5.50V	4.75-5.25V (No potentiometer)	4.75-5.25V (No potentiometer)
Output Current	60.0A	60.0A	60.0A	60.0A	60.0A
Output Power	300W	300W	300W	300W	300W
Line Regulation	< 0.5%				
Load Regulation	< 1.0%			NA	
PARD (20MHz)	< 150mVpp				
Hold-up Time	8ms typ.				
INPUT					
Phase Input	Single Phase				
Input Voltage Range	88-264Vac				
Input Frequency	47-63Hz				
Input Current	4.5A typ. @ 115Vac, 2.5A typ. @ 230Vac		5.0A typ. @ 115Vac, 2.5A typ. @ 230Vac		
Efficiency ¹⁾ at 100% Load	81.0% typ. @ 115Vac, 84.0% typ. @ 230Vac		86.0% typ. @ 115Vac, 88.0% typ. @ 230Vac		85.0% typ. @ 115Vac, 87.0% typ. @ 230Vac
Max Inrush Current (Cold Start)	20A typ. @ 115Vac, 40A typ. @ 230Vac				
Power Factor	0.98 typ. @ 115Vac, 0.95 typ. @ 230Vac				
Leakage Current	< 0.5mA @ 240Vac		< 1mA @ 240Vac		
MECHANICAL					
Case Cover / Chassis	Aluminium				
Dimensions (L x W x H)	215 x 115 x 30 mm (8.46" x 4.53" x 1.18")	215 x 115 x 30 mm (8.46" x 4.53" x 1.18")	215 x 115 x 30 mm (8.46" x 4.53" x 1.18")	215 x 115 x 30 mm (8.46" x 4.53" x 1.18")	215 x 115 x 30 mm (8.46" x 4.53" x 1.18")
Unit Weight	0.76 kg (1.68 lb)	0.86 kg (1.90 lb)	0.86 kg (1.90 lb)	0.86 kg (1.90 lb)	0.86 kg (1.90 lb)
Cooling System	Forced Air (Built-in Fan)	Convection			
MTBF ²⁾	> 700,000 hrs	> 700,000 hrs	> 700,000 hrs	> 700,000 hrs	> 700,000 hrs
ENVIRONMENT					
Operating Temperature	-10°C to +70°C		-20°C to +70°C		
Storage Temperature	-40°C to +85°C				
Power De-rating	> 50°C (2.5% / °C)		> 40°C (1% / °C), > 50°C (1.5% / °C)		
Operating Humidity	5 to 95% RH (Non-Condensing)				
Operating Altitude	0 to 5,000 m (0 to 16,400 ft)				

Dimensions Reference

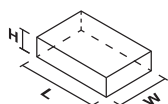

Notes

- 1) At 25°C ambient temperature by vertical mounting orientation.
- 2) MTBF as per Telcordia SR-332 (Confidence level: 90%, I/P: 100Vac, O/P: 100% load, Ta: 35°C). For PMR-5V320WC□A, MTBF calculation does not include fan life time.
- 3) All parameters are specified at 25°C ambient temperature unless otherwise indicated.

PMU Panel Mount Power Supply

13.8V, 27.6V Output

PMU



HIGHLIGHTS & FEATURES

- AC input voltage range selectable by switch
- LED indicators for DC OK (Green) and Battery Reverse Polarity Connection (Red)
- Zero switch over time from loss of AC to battery operation
- Conforms to harmonic current IEC/EN 61000-3-2, Class A
- High MTBF > 700,000 hrs. per Telcordia SR-332
- Monitoring signals for AC OK, DC OK and Battery Low indication
- Overvoltage / Overcurrent / Over Temperature / Short Circuit Protections

GENERAL SPECIFICATIONS

OUTPUT	PMU-13V155W□BA	PMU-13V155W□CA	PMU-27V155W□BA	PMU-27V155W□CA
Output Voltage	V1: 13.8V, B+: 13.3V	V1: 13.8V, B+: 13.3V	V1: 27.6V, B+: 27.1V	V1: 27.6V, B+: 27.1V
Output Voltage Range	12-14V	12-14V	24-28V	24-28V
Output Current	V1: 9.5A (0-11.0A) B+: 1.5A (0.5-1.5A)	V1: 9.5A (0-11.0A) B+: 1.5A (0.5-1.5A)	PMU-27V155WCBA V1: 4.0A (0-5.5A) B+: 1.5A (0.5-1.5A) PMU-27V155WLBA V1: 4.3A (0-5.5A) B+: 1.2A (0.50-1.2A)	PMU-27V155WCBA V1: 4.0A (0-5.5A) B+: 1.5A (0.5-1.5A) PMU-27V155WLCA V1: 4.3A (0-5.5A) B+: 1.2A (0.50-1.2A)
Output Power	151W	151W	151W	151W
Line Regulation	< 0.5% (90-132Vac @ 90% load, 180-264Vac @ 100% load)			
Load Regulation	< 1.0% (90-132Vac @ 0-90% load, 180-264Vac @ 0-100% load)			
PARD (20MHz)	< 150mVpp @ 0°C to -20°C, < 100mVpp @ > 0°C to 70°C			
Hold-up Time	20ms without Battery at B+			
INPUT				
Phase Input	Single Phase			
Input Voltage Range	90-132Vac, 180-264Vac (Selectable by Switch)			
Input Frequency	47-63Hz			
Input Current	< 2.5A @ 115Vac, < 1.5A @ 230Vac			
Efficiency ¹⁾ at 100% Load	> 85.0% @ 115Vac, > 86.0% @ 230Vac		> 88.0% @ 115Vac, > 89.0% @ 230vac	
Max Inrush Current (Cold Start)	< 25A @ 115Vac & 230Vac			
Power Factor	Conform to EN 61000-3-2			
Leakage Current	< 0.5mA @ 264Vac			
MECHANICAL				
Case Cover / Chassis	SGCC / Aluminium			
Dimensions (L x W x H)	178 x 97 x 38 mm (7.01" x 3.82" x 1.50")	178 x 97 x 38 mm (7.01" x 3.82" x 1.50")	178 x 97 x 38 mm (7.01" x 3.82" x 1.50")	178 x 97 x 38 mm (7.01" x 3.82" x 1.50")
Unit Weight	0.59 kg (1.30 lb)	0.60 kg (1.32 lb)	0.59 kg (1.30 lb)	0.60 kg (1.32 lb)
Cooling System	Convection			
MTBF ²⁾	> 700,000 hrs	> 700,000 hrs	> 700,000 hrs	> 700,000 hrs
ENVIRONMENT				
Operating Temperature	-20°C to +70°C			
Storage Temperature	-40°C to +85°C			
Power De-rating	90-132Vac: < 0°C to -20°C (2.25% / °C), > 50°C (2.25% / °C) 180-264Vac: < 0°C to -20°C (2.5% / °C), > 50°C (2.5% / °C)			
Operating Humidity	5 to 95% RH (Non-Condensing)			
Operating Altitude	0 to 5,000 m (0 to 16,400 ft)			

Dimensions Reference

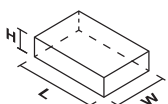

Notes

- 1) At 25°C ambient temperature by vertical mounting orientation.
- 2) MTBF as per Telcordia SR-332 (Confidence level: 90%, I/P: 115Vac, O/P: 100% load) for vertical mounting orientation.
- 3) All parameters are specified at 25°C ambient temperature unless otherwise indicated.

Delta Industrial Power Supplies

Open Frame Power Supply



AR

PJT



- Universal AC input voltage range
- Standard industrial footprint
- Low Leakage Current
- Convection cooled operating temperature range from -10°C to +70°C
- High MTBF > 700,000 hrs as per Telcordia SR-332
- Multiple connector sources options (JWT, JST, Molex)

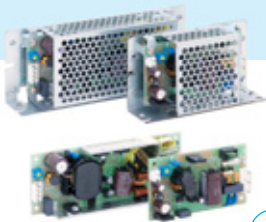

AR

PJ



- Universal AC input voltage range
- High PF > 0.97 (for 50W and above)
- Low Inrush Current / Low Leakage Current
- Conformal coating on PCBAs to protect against common dust and chemical pollutants
- Versatile configuration options: Open Frame, L Frame, Enclosed
- Remote ON/OFF option for selected models
- Long life capacitors



AR

PJB



- Universal AC input voltage range
- Power Boost of 200% for 10 seconds
- High PF > 0.97
- Low Inrush Current / Low Leakage Current
- Conformal coating on PCBAs to protect against common dust and chemical pollutants
- Versatile configuration options: Open Frame, L Frame, Enclosed
- Remote ON/OFF option for selected models

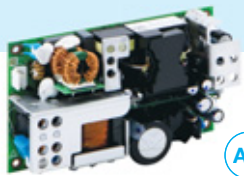

AR

PJH



- Household appliance approval to IEC/EN 60335-1, IEC/EN 61558-1 and IEC/EN 61558-2-16
- Available for Class I or Class II (double isolation) configuration with universal AC input voltage range
- 300W with fan cooled and up to 240W convection cooled
- Standard industrial footprint of 3" x 5"
- Built-in active PFC, remote On/Off, remote sense, power good signal
- No load input power consumption < 0.5W and low earth leakage current < 0.75mA
- Extreme low temperature cold start at -40°C



AR

PJU



- Universal AC input voltage range
- Zero switch over time from loss of AC to battery operation
- Protection against reverse polarity battery connection
- Built-in diagnostic monitoring for AC OK and Battery Low status
- Overvoltage / Overcurrent / Over Temperature / Short Circuit Protections
- Built-in over current and short circuit protection in Buffering (battery discharging) mode operation



MDS



AR

- Safety approvals for medical and IT applications
- Over-Voltage/Load/Temperature & Short Circuit Protections
- Low touch current (< 0.1mA Normal & < 0.3mA Single Fault)
- Compliant with IEC 60601-1-2 4th Ed. Requirements
- Power Good Signal, Remote Sense, Remote inhibit
- 2 × MOPP isolation

PAGES 81-88

MEP



AR

- Safety approvals to medical and IT applications
- Compliant with IEC 60601-1-2 4th Ed. Requirements
- Low leakage current (< 70µA Normal & < 210µA Single Fault)
- Over-Voltage/Load/Temperature & Short Circuit protections
- 3 million hours MTBF
- 2 × MOPP isolation

PAGE 89

MEU



AR

- Universal AC input
- Up to 500K hours MTBF
- 2 × MOPP isolation
- Safety approvals to medical and IT applications
- Compliant with IEC 60601-1-2 4th Ed. Requirements
- Over-Voltage/Load/Temperature & Short Circuit protections

PAGE 90

Configuration Options

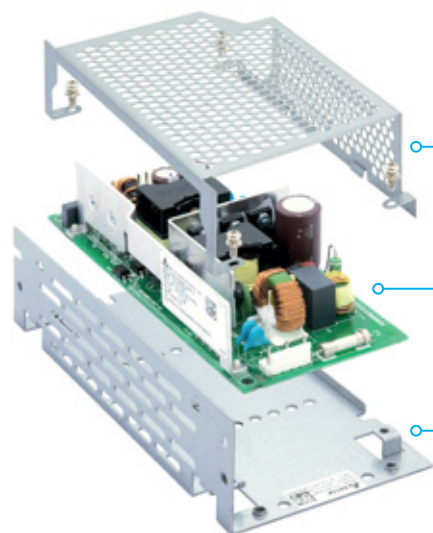

Enclosed

Open Frame

L Frame

For the PJ series, PJB series and PJU series, metal chassis and case cover are available as options for different installation preferences.

PJT Open Frame Power Supply

12V Output

PJT

HIGHLIGHTS & FEATURES

- Universal AC input voltage range
- Small standard footprint
- Low Leakage Current < 0.1mA
- Conforms to harmonic current IEC/EN 61000-3-2, Class A
- High MTBF > 700,000 hrs. as per Telcordia SR-332
- Short Circuit / Overvoltage / Overcurrent / Over Temperature Protections



GENERAL SPECIFICATIONS

OUTPUT	PJT-12V40WBA□	PJT-12V65WBA□	PJT-12V100WBA□	PJT-12V100WBB□
Output Voltage	12V	12V	12V	12V
Output Current	3.33A	5.0A	8.33A	6.67A (Convection) 8.33A (Forced Air)
Output Power	40W	60W	100W	80W (Convection) 100W (Forced Air)
Line Regulation	< 0.5%			
Load Regulation	< 1.0%			
PARD (20MHz)	< 120mVpp			
Hold-up Time	18ms typ. @ 115Vac, 90ms typ. @ 230Vac	16ms typ. @ 115Vac, 80ms typ. @ 230Vac	20ms typ. @ 115Vac & 230Vac	10ms typ. @ 115Vac % 230Vac
INPUT				
Phase Input	Single Phase			
Input Voltage Range	90-264Vac			
Input Frequency	47-63Hz			
Input Current	0.85A typ. @ 115Vac	1.50A typ. @ 115Vac		2.50A typ. @ 115Vac
Efficiency ¹⁾ at 100% Load	85.0% typ. @ 115Vac, 86.0% typ. @ 230Vac	86.0% typ. @ 115Vac, 86.5% typ. @ 230Vac	86.5% typ. @ 115Vac & 230Vac	86.0% typ. @ 115Vac, 88.0% typ. @ 230Vac
Max Inrush Current (Cold Start)	30A typ. @ 115Vac, 60A typ. @ 230Vac			
Power Factor	Conform to EN 61000-3-2			
Leakage Current	< 0.1mA @ 240Vac			
MECHANICAL				
Case Cover / Chassis	-			
Dimensions (L x W x H)	76.2 x 50.8 x 22.9 mm (3.00" x 2.00" x 0.90")	101.6 x 50.8 x 30 mm (4.00" x 2.00" x 1.18")	127 x 76.2 x 31 mm (5.00" x 3.00" x 1.22")	101.6 x 50.8 x 31.8 mm (4.00" x 2.00" x 1.25")
Unit Weight	0.08 kg (0.18 lb)	0.13 kg (0.29 lb)	0.21 kg (0.46 lb)	0.15 kg (0.33 lb)
Cooling System	Convection			Convection / Forced Air
MTBF ²⁾	> 700,000 hrs	> 700,000 hrs	> 700,000 hrs	> 700,000 hrs
ENVIRONMENT				
Operating Temperature	-10°C to +70°C			
Storage Temperature	-40°C to +85°C			
Power De-rating	> 50°C (2.5% / °C)			Convection: > 50°C (2% / °C) Forced Air: > 50°C (2.5% / °C)
Operating Humidity	10 to 95% RH (Non-Condensing)			
Operating Altitude	0 to 5,000 m (0 to 16,400 ft)			

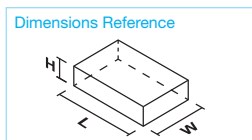

- Notes
- 1) At 25°C ambient temperature.
 - 2) MTBF as per Telcordia SR-332 (I/P: 115Vac, O/P: 100% load).
 - 3) All parameters are specified at 25°C ambient temperature unless otherwise indicated.

HIGHLIGHTS & FEATURES

- Universal AC input voltage range
- Small standard footprint
- Low Leakage Current < 0.1mA
- Conforms to harmonic current IEC/EN 61000-3-2, Class A
- High MTBF > 700,000 hrs. as per Telcordia SR-332
- Short Circuit / Overvoltage / Overcurrent / Over Temperature Protections

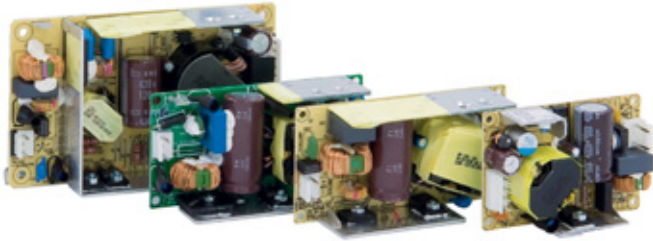

GENERAL SPECIFICATIONS

OUTPUT	PJT-15V40WBA□	PJT-15V65WBA□	PJT-15V100WBA□	PJT-15V100WBB□
Output Voltage	15V	15V	15V	15V
Output Current	2.67A	4.2A	6.67A	5.33A (Convection) 6.67A (Forced Air)
Output Power	40W	63W	100W	80W (Convection) 100W (Forced Air)
Line Regulation	< 0.5%			
Load Regulation	< 1.0%			
PARD (20MHz)	< 150mVpp			
Hold-up Time	18ms typ. @ 115Vac, 90ms typ. @ 230Vac	16ms typ. @ 115Vac, 80ms typ. @ 230Vac	20ms typ. @ 115Vac % 230Vac	10ms typ. @ 115Vac & 230Vac
INPUT				
Phase Input	Single Phase			
Input Voltage Range	90-264Vac			
Input Frequency	47-63Hz			
Input Current	0.85A typ. @ 115Vac	1.50A typ. @ 115Vac		2.50A typ. @ 115Vac
Efficiency ¹⁾ at 100% Load	86.0% typ. @ 115Vac, 87.0% typ. @ 230Vac	87.0% typ. @ 115Vac, 88.5% typ. @ 230Vac	87.5% typ. @ 115Vac & 230Vac	87.0% typ. @ 115Vac, 89.0% typ. @ 230Vac
Max Inrush Current (Cold Start)	30A typ. @ 115Vac, 60A typ. @ 230Vac			
Power Factor	Conform to EN 61000-3-2			
Leakage Current	< 0.1mA @ 240Vac			
MECHANICAL				
Case Cover / Chassis	-			
Dimensions (L x W x H)	76.2 x 50.8 x 22.9 mm (3.00" x 2.00" x 0.90")	101.6 x 50.8 x 30 mm (4.00" x 2.00" x 1.18")	127 x 76.2 x 31 mm (5.00" x 3.00" x 1.22")	101.6 x 50.8 x 31.8 mm (4.00" x 2.00" x 1.25")
Unit Weight	0.08 kg (0.18 lb)	0.13 kg (0.29 lb)	0.21 kg (0.46 lb)	0.15 kg (0.33 lb)
Cooling System	Convection			Convection / Forced Air
MTBF ²⁾	> 700,000 hrs	> 700,000 hrs	> 700,000 hrs	> 700,000 hrs
ENVIRONMENT				
Operating Temperature	-10°C to +70°C			
Storage Temperature	-40°C to +85°C			
Power De-rating	> 50°C (2.5% / °C)			Convection: > 50°C (2% / °C) Forced Air: > 50°C (2.5% / °C)
Operating Humidity	10 to 95% RH (Non-Condensing)			
Operating Altitude	0 to 5,000 m (0 to 16,400 ft)			

Dimensions Reference

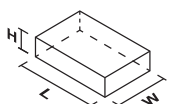

Notes

- 1) At 25°C ambient temperature.
- 2) MTBF as per Telcordia SR-332 (I/P: 115Vac, O/P: 100% load).
- 3) All parameters are specified at 25°C ambient temperature unless otherwise indicated.

PJT Open Frame Power Supply

18V Output

PJT

HIGHLIGHTS & FEATURES

- Universal AC input voltage range
- Small standard footprint
- Low Leakage Current < 0.1mA
- Conforms to harmonic current IEC/EN 61000-3-2, Class A
- High MTBF > 700,000 hrs. as per Telcordia SR-332
- Short Circuit / Overvoltage / Overcurrent / Over Temperature Protections



GENERAL SPECIFICATIONS

OUTPUT	PJT-18V40WBA□	PJT-18V65WBA□	PJT-18V100WBA□	PJT-18V100WBB□
Output Voltage	18V	18V	18V	18V
Output Current	2.22A	3.61A	5.55A	4.44A (Convection) 5.55A (Forced Air)
Output Power	40W	65W	100W	80W (Convection) 100W (Forced Air)
Line Regulation	< 0.5%			
Load Regulation	< 1.0%			
PARD (20MHz)	< 180mVpp			
Hold-up Time	18ms typ. @ 115Vac, 90ms typ. @ 230Vac	16ms typ. @ 115Vac, 80ms typ. @ 230Vac	20ms typ. @ 115Vac & 230Vac	10ms typ. @ 115Vac & 230Vac
INPUT				
Phase Input	Single Phase			
Input Voltage Range	90-264Vac			
Input Frequency	47-63Hz			
Input Current	0.85A typ. @ 115Vac	1.50A typ. @ 115Vac		2.50A typ. @ 115Vac
Efficiency ¹⁾ at 100% Load	86.0% typ. @ 115Vac & 230Vac	87.0% typ. @ 115Vac, 88.0% typ. @ 230Vac	87.5% typ. @ 115Vac & 230Vac	87.0% typ. @ 115Vac, 89.0% typ. @ 230Vac
Max Inrush Current (Cold Start)	30A typ. @ 115Vac, 60A typ. @ 230Vac			
Power Factor	Conform to EN 61000-3-2			
Leakage Current	< 0.1mA @ 240Vac			
MECHANICAL				
Case Cover / Chassis	-			
Dimensions (L x W x H)	76.2 x 50.8 x 22.9 mm (3.00" x 2.00" x 0.90")	101.6 x 50.8 x 30 mm (4.00" x 2.00" x 1.18")	127 x 76.2 x 31 mm (5.00" x 3.00" x 1.22")	101.6 x 50.8 x 31.8 mm (4.00" x 2.00" x 1.25")
Unit Weight	0.08 kg (0.18 lb)	0.13 kg (0.29 lb)	0.21 kg (0.46 lb)	0.15 kg (0.33 lb)
Cooling System	Convection			Convection / Forced Air
MTBF ²⁾	> 700,000 hrs	> 700,000 hrs	> 700,000 hrs	> 700,000 hrs
ENVIRONMENT				
Operating Temperature	-10°C to +70°C			
Storage Temperature	-40°C to +85°C			
Power De-rating	> 50°C (2.5% / °C)			Convection: > 50°C (2% / °C) Forced Air: > 50°C (2.5% / °C)
Operating Humidity	10 to 95% RH (Non-Condensing)			
Operating Altitude	0 to 5,000 m (0 to 16,400 ft)			

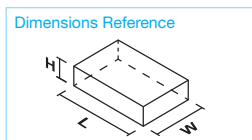

- Notes
- 1) At 25°C ambient temperature.
 - 2) MTBF as per Telcordia SR-332 (I/P: 115Vac, O/P: 100% load).
 - 3) All parameters are specified at 25°C ambient temperature unless otherwise indicated.

24V, 27V Output

PJT

HIGHLIGHTS & FEATURES

- Universal AC input voltage range
- Small standard footprint
- Low Leakage Current
- Conforms to harmonic current IEC/EN 61000-3-2, Class A
- High MTBF > 700,000 hrs. as per Telcordia SR-332
- Short Circuit / Overvoltage / Overcurrent / Over Temperature Protections



GENERAL SPECIFICATIONS

OUTPUT	PJT-24V40WBA□	PJT-24V65WBA□	PJT-24V100WBA□	PJT-24V100WBB□	PJT-27V150WBNA
Output Voltage	24V	24V	24V	24V	V1: 27V, V _{SB} : 12V
Output Current	1.66A	2.71A	4.17A	3.33A (Convection) 4.17A (Forced Air)	V1: 5.55A V _{SB} : 0.5A
Output Power	40W	65W	100W	80W (Convection) 100W (Forced Air)	V1: 150W V _{SB} : 6W
Line Regulation	< 0.5%				< 0.5% (@ 90-264Vac input, 100% load)
Load Regulation	< 1.0%				< 1.0% (@ 90-264Vac input, 0-100% load)
PARD (20MHz)	< 240mVpp				V1: < 150mVpp, V _{SB} : < 75mVpp
Hold-up Time	18ms typ. @ 115Vac, 90ms typ. @ 230Vac	16ms typ. @ 115Vac, 80ms typ. @ 230Vac	20ms typ. @ 115Vac & 230Vac	10ms typ. @ 115Vac & 230Vac	> 40ms @ 115Vac & 230Vac
INPUT					
Phase Input	Single Phase				
Input Voltage Range	90-264Vac				85-264Vac
Input Frequency	47-63Hz				
Input Current	0.85A typ. @ 115Vac	1.50A typ. @ 115Vac		2.50A typ. @ 115Vac	< 1.80A @ 115Vac, < 0.90A @ 230Vac
Efficiency ¹⁾ at 100% Load	86.0% typ. @ 115Vac, 87.0% typ. @ 230Vac	87.0% typ. @ 115Vac & 230Vac	88.0% typ. @ 115Vac & 230Vac	88.0% typ. @ 115Vac, 89.0% typ. @ 230Vac	> 88.5% @ 115Vac, > 89.5% @ 230Vac
Max Inrush Current (Cold Start)	30A typ. @ 115Vac, 60A typ. @ 230Vac				< 50A @ 115Vac, < 100A @ 230Vac
Power Factor	Conform to EN 61000-3-2				> 0.99 @ 115Vac, > 0.93 @ 230Vac
Leakage Current	< 0.1mA @ 240Vac				< 0.25mA @ 264Vac
MECHANICAL					
Case Cover / Chassis	-				
Dimensions (L × W × H)	76.2 × 50.8 × 22.9 mm (3.00" × 2.00" × 0.90")	101.6 × 50.8 × 30 mm (4.00" × 2.00" × 1.18")	127 × 76.2 × 31 mm (5.00" × 3.00" × 1.22")	101.6 × 50.8 × 31.8 mm (4.00" × 2.00" × 1.25")	127 × 76.2 × 36.5 mm (5.00" × 3.00" × 1.44")
Unit Weight	0.08 kg (0.18 lb)	0.13 kg (0.29 lb)	0.21 kg (0.46 lb)	0.15 kg (0.33 lb)	0.37 kg (0.82 lb)
Cooling System	Convection			Convection / Forced Air	Convection
MTBF ²⁾	> 700,000 hrs	> 700,000 hrs	> 700,000 hrs	> 700,000 hrs	> 700,000 hrs
ENVIRONMENT					
Operating Temperature	-10°C to +70°C				
Storage Temperature	-40°C to +85°C				
Power De-rating	PJT-24V40WBA□, PJT-24V65WBA□, PJT-24V100WBA□, PJT-27V150WBNA□: > 50°C (2.5% / °C) PJT-24V100WBB□: Convection: > 50°C (2% / °C); Forced Air: > 50°C (2.5% / °C)				
Operating Humidity	10 to 95% RH (Non-Condensing); PJT-27V150WBNA: 5 to 95% RH (Non-Condensing)				
Operating Altitude	0 to 5,000 m (0 to 16,400 ft)				

Dimensions Reference

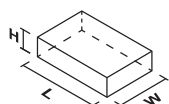

Notes

- 1) At 25°C ambient temperature.
- 2) MTBF as per Telcordia SR-332 (I/P: 115Vac, O/P: 100% load).
- 3) All parameters are specified at 25°C ambient temperature unless otherwise indicated.

PJ Open Frame Power Supply

12V Output



PJ

HIGHLIGHTS & FEATURES

- Universal AC input voltage range
- High PF > 0.97 (for 50W and above)
- Low Inrush Current / Low Leakage Current
- Conforms to harmonic current IEC/EN 61000-3-2, Class A; Class A and Class D for 50W and above
- Conformal coating on PCBAs to protect against common dust and chemical pollutants
- Versatile configuration options: Open Frame, L Frame, Enclosed
- Remote ON/OFF option for selected models
- Long life capacitors

GENERAL SPECIFICATIONS

OUTPUT	PJ-12V15W□□A	PJ-12V30W□□A	PJ-12V50W□□A	PJ-12V100W□□A	PJ-12V150W□□A
Output Voltage	12V	12V	12V	12V	12V
Output Voltage Range	10.8-13.2V	10.8-13.2V	10.8-13.2V	10.8-13.2V	10.8-13.2V
Output Current	1.3A	2.5A	4.3A	8.5A	12.5A
Output Power	15.6W	30W	51.6W	102W	150W
Line Regulation	< 48mV				
Load Regulation	< 100mV				
PARD (20MHz)	< 150mVpp				
Hold-up Time	20ms typ. @ 100Vac				
INPUT					
Phase Input	Single Phase				
Input Voltage Range	85-264Vac				
Input Frequency	47-63Hz				
Input Current	0.35A typ. @ 100Vac, 0.20A typ. @ 200Vac	0.65A typ. @ 100Vac, 0.35A typ. @ 200Vac	0.65A typ. @ 100Vac, 0.35A typ. @ 200Vac	1.30A typ. @ 100Vac, 0.65A typ. @ 200Vac	1.90A typ. @ 100Vac, 0.95A typ. @ 200Vac
Efficiency ¹⁾ at 100% Load	81.0% typ. @ 100Vac, 82.5% typ. @ 200Vac	83.0% typ. @ 100Vac, 85.0% typ. @ 200Vac	83.0% typ. @ 100Vac, 85.0% typ. @ 200Vac	85.0% typ. @ 100Vac, 87.5% typ. @ 200Vac	88.0% typ. @ 100Vac, 91.0% typ. @ 200Vac
Max Inrush Current (Cold Start)	15A typ. @ 100Vac, 30A typ. @ 200Vac				
Power Factor	Conform to EN 61000-3-2		0.98 typ. @ 100Vac, 0.97 typ. @ 200Vac	0.99 typ. @ 100Vac, 0.98 typ. @ 200Vac	0.99 typ. @ 100Vac, 0.97 typ. @ 200Vac
Leakage Current	< 0.1mA @ 100Vac, < 0.2mA @ 240Vac			< 0.2mA @ 100Vac, < 0.4mA @ 240Vac	
MECHANICAL					
Case Cover / Chassis	SGCC				
Dimensions (L x W x H) ²⁾	87.5 x 50 x 22 mm (3.44" x 1.97" x 0.87")	105 x 50 x 25.6 mm (4.13" x 1.97" x 1.01")	132 x 50 x 26.6 mm (5.20" x 1.97" x 1.05")	155 x 62 x 33.5 mm (6.10" x 2.44" x 1.32")	160 x 75 x 37 mm (6.30" x 2.95" x 1.46")
Unit Weight ²⁾	0.06 kg (0.13 lb)	0.11 kg (0.24 lb)	0.16 kg (0.35 lb)	0.26 kg (0.57 lb)	0.30 kg (0.66 lb)
Cooling System	Convection				
MTBF ³⁾	> 200,000 hrs	> 200,000 hrs	> 200,000 hrs	> 200,000 hrs	> 200,000 hrs
ENVIRONMENT					
Operating Temperature	-10°C to +70°C				
Storage Temperature	-25°C to +75°C				
Power De-rating ²⁾	> 50°C (2.5% / °C)				> 50°C (2% / °C)
Operating Humidity	5 to 95% RH (Non-Condensing)				
Operating Altitude	0 to 5,000 m (0 to 16,400 ft)				

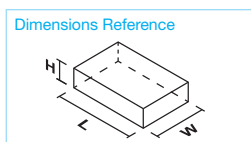

Notes

- 1) At 25°C ambient temperature.
- 2) Open Frame (without chassis and cover).
- 3) MTBF as per JEITA RCR-9102B.
- 4) All parameters are specified at 25°C ambient temperature unless otherwise indicated.

24V Output

PJ

HIGHLIGHTS & FEATURES

- Universal AC input voltage range
- High PF > 0.97 (for 50W and above)
- Low Inrush Current / Low Leakage Current
- Conforms to harmonic current IEC/EN 61000-3-2, Class A; Class A and Class D for 50W and above
- Conformal coating on PCBAs to protect against common dust and chemical pollutants
- Versatile configuration options: Open Frame, L Frame, Enclosed
- Remote ON/OFF option for selected models
- Long life capacitors

AR

GENERAL SPECIFICATIONS

OUTPUT	PJ-24V30W□□A	PJ-24V50W□□A	PJ-24V100W□□A	PJ-24V150W□□A
Output Voltage	24V	24V	24V	24V
Output Voltage Range	21.6-26.4V	21.6-26.4V	21.6-26.4V	21.6-26.4V
Output Current	1.3A	2.1A	4.3A	6.3A
Output Power	31.2W	50.4W	103.2W	150W
Line Regulation	< 96mV			
Load Regulation	< 150mV			
PARD (20MHz)	< 150mVpp			
Hold-up Time	20ms typ. @ 100Vac			
INPUT				
Phase Input	Single Phase			
Input Voltage Range	85-264Vac			
Input Frequency	47-63Hz			
Input Current	0.65A typ. @ 100Vac, 0.35A typ. @ 200Vac	0.65A typ. @ 100Vac, 0.35A typ. @ 200Vac	1.30A typ. @ 100Vac, 0.65A typ. @ 200Vac	1.90A typ. @ 100Vac, 0.95A typ. @ 200Vac
Efficiency ¹⁾ at 100% Load	85.0% typ. @ 100Vac, 86.0% typ. @ 200Vac	84.5% typ. @ 100Vac, 87.0% typ. @ 200Vac	86.0% typ. @ 100Vac, 89.0% typ. @ 200Vac	88.0% typ. @ 100Vac, 91.0% typ. @ 200Vac
Max Inrush Current (Cold Start)	15A typ. @ 100Vac, 30A typ. @ 200Vac			
Power Factor	Conform to EN 61000-3-2	0.98 typ. @ 100Vac, 0.97 typ. @ 200Vac	0.99 typ. @ 100Vac, 0.98 typ. @ 200Vac	0.99 typ. @ 100Vac, 0.97 typ. @ 200Vac
Leakage Current	< 0.1mA @ 100Vac, < 0.2mA @ 240Vac		< 0.2mA @ 100Vac, < 0.4mA @ 240Vac	
MECHANICAL				
Case Cover / Chassis	SGCC			
Dimensions (L x W x H) ²⁾	105 x 50 x 25.6 mm (4.13" x 1.97" x 1.01")	132 x 50 x 26.6 mm (5.20" x 1.97" x 1.05")	155 x 62 x 33.5 mm (6.10" x 2.44" x 1.32")	160 x 75 x 37 mm (6.30" x 2.95" x 1.46")
Unit Weight ²⁾	0.11 kg (0.24 lb)	0.16 kg (0.35 lb)	0.26 kg (0.57 lb)	0.29 kg (0.64 lb)
Cooling System	Convection			
MTBF ³⁾	> 200,000 hrs	> 200,000 hrs	> 200,000 hrs	> 200,000 hrs
ENVIRONMENT				
Operating Temperature	-10°C to +70°C			
Storage Temperature	-25°C to +75°C			
Power De-rating ²⁾	> 50°C (2.5% / °C)			> 50°C (2% / °C)
Operating Humidity	5 to 95% RH (Non-Condensing)			
Operating Altitude	0 to 5,000 m (0 to 16,400 ft)			

Dimensions Reference

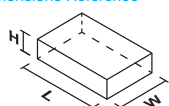

Notes

- 1) At 25°C ambient temperature.
- 2) Open Frame (without chassis and cover).
- 3) MTBF as per JEITA RCR-9102B.
- 4) All parameters are specified at 25°C ambient temperature unless otherwise indicated.

PJ Open Frame Power Supply

5V, 48V Output



PJ

HIGHLIGHTS & FEATURES

- Universal AC input voltage range
- High PF > 0.97 (for 50W)
- Low Inrush Current / Low Leakage Current
- Conforms to harmonic current IEC/EN 61000-3-2, Class A; Class A and Class D for 50W
- Conformal coating on PCBAs to protect against common dust and chemical pollutants
- Versatile configuration options: Open Frame, L Frame, Enclosed
- Long life capacitors

GENERAL SPECIFICATIONS

OUTPUT	PJ-5V15W□□A	PJ-48V50W□□A
Output Voltage	5V	48V
Output Voltage Range	4.50-5.50V	43.2-52.8V
Output Current	3.0A	1.1A
Output Power	15W	52.8W
Line Regulation	< 20mV	< 192mV
Load Regulation	< 40mV	< 240mV
PARD (20MHz)	< 120mVpp	< 250mVpp
Hold-up Time	20ms typ. @ 100Vac	
INPUT		
Phase Input	Single Phase	
Input Voltage Range	85-264Vac	
Input Frequency	47-63Hz	
Input Current	0.35A typ. @ 100Vac, 0.20A typ. @ 200Vac	0.65A typ. @ 100Vac, 0.35A typ. @ 200Vac
Efficiency ¹⁾ at 100% Load	78.0% typ. @ 100Vac, 79.5% typ. @ 200Vac	83.0% typ. @ 100Vac, 85.0% typ. @ 200Vac
Max Inrush Current (Cold Start)	15A typ. @ 100Vac, 30A typ. @ 200Vac	
Power Factor	Conform to EN 61000-3-2	0.98 typ. @ 100Vac, 0.97 typ. @ 200Vac
Leakage Current	< 0.1mA @ 100Vac, < 0.2mA @ 240Vac	
MECHANICAL		
Case Cover / Chassis	SGCC	
Dimensions (L x W x H) ²⁾	87.5 x 50 x 22 mm (3.44" x 1.97" x 0.87")	132 x 50 x 26.6 mm (5.20" x 1.97" x 1.05")
Unit Weight ²⁾	0.06 kg (0.13 lb)	0.16 kg (0.35 lb)
Cooling System	Convection	
MTBF ³⁾	> 200,000 hrs	> 200,000 hrs
ENVIRONMENT		
Operating Temperature	-10°C to +70°C	
Storage Temperature	-25°C to +75°C	
Power De-rating ²⁾	> 50°C (2.5% / °C)	
Operating Humidity	5 to 95% RH (Non-Condensing)	
Operating Altitude	0 to 5,000 m (0 to 16,400 ft)	

Dimensions Reference

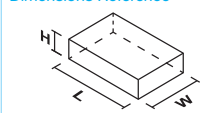

Notes

- 1) At 25°C ambient temperature.
- 2) Open Frame (without chassis and cover).
- 3) MTBF as per JEITA RCR-9102B.
- 4) All parameters are specified at 25°C ambient temperature unless otherwise indicated.

PJB Open Frame Power Supply

24V Output



PJB

HIGHLIGHTS & FEATURES

- Universal AC input voltage range
- Power Boost of 200% for 10 seconds
- High PF > 0.97
- Low Inrush Current / Low Leakage Current
- Conforms to harmonic current IEC/EN 61000-3-2, Class A
- Conformal coating on PCBAs to protect against common dust and chemical pollutants
- Versatile configuration options: Open Frame, L Frame, Enclosed
- Remote ON/OFF option for selected models

GENERAL SPECIFICATIONS

OUTPUT	PJB-24V100W□□A	PJB-24V150W□□A	PJB-24V240W□□A
Output Voltage	24V	24V	24V
Output Voltage Range	21.6-26.4V	21.6-26.4V	21.6-26.4V
Output Current	4.3A (8.6A for 10s)	6.3A (12.6A for 10s)	10.0A (20.0A for 10s)
Output Power	103.2W (206.4W for 10s)	151.2W (302.4W for 10s)	240W (480W for 10s)
Line Regulation	< 96mV		
Load Regulation	< 150mV		
PARD (20MHz)	< 150mVpp		
Hold-up Time	20ms typ. @ 100Vac		
INPUT			
Phase Input	Single Phase		
Input Voltage Range	85-264Vac		
Input Frequency	47-63Hz		
Input Current	1.30A typ. @ 100Vac, 0.65A typ. @ 200Vac	1.90A typ. @ 100Vac, 0.95A typ. @ 200Vac	2.80A typ. @ 100Vac, 1.50A typ. @ 200Vac
Efficiency ¹⁾ at 100% Load	86.5% typ. @ 100Vac, 89.0% typ. @ 200Vac	88.0% typ. @ 100Vac, 90.5% typ. @ 200Vac	91.0% typ. @ 100Vac, 92.5% typ. @ 200Vac
Max Inrush Current (Cold Start)	15A typ. @ 100Vac, 30A typ. @ 200Vac		
Power Factor	0.98 typ. @ 100Vac, 0.97 typ. @ 200Vac	0.98 typ. @ 100Vac, 0.95 typ. @ 200Vac	0.98 typ. @ 100Vac, 0.97 typ. @ 200Vac
Leakage Current	< 0.2mA @ 100Vac, < 0.4mA @ 240Vac		
MECHANICAL			
Case Cover / Chassis	SGCC		
Dimensions (L x W x H) ²⁾	155 x 62 x 33.5 mm (6.10" x 2.44" x 1.32")	160 x 75 x 37 mm (6.30" x 2.95" x 1.46")	180 x 84 x 42 mm (7.09" x 3.31" x 1.65")
Unit Weight ²⁾	0.26 kg (0.57 lb)	0.31 kg (0.68 lb)	0.44 kg (0.97 lb)
Cooling System	Convection		
MTBF ³⁾	> 200,000 hrs	> 200,000 hrs	> 200,000 hrs
ENVIRONMENT			
Operating Temperature	-10°C to +70°C		
Storage Temperature	-25°C to +75°C		
Power De-rating ²⁾	> 50°C (2.5% / °C)	> 50°C (2% / °C)	
Operating Humidity	5 to 95% RH (Non-Condensing)		
Operating Altitude	0 to 5,000 m (0 to 16,400 ft)		ITE Application: 0 to 5,000 m (0 to 16,400 ft) PSE Class 1: 0 to 2,000 m (0 to 6,560 ft)

Dimensions Reference

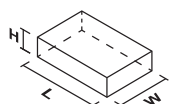

Notes

- 1) At 25°C ambient temperature.
- 2) Open Frame (without chassis and cover).
- 3) MTBF as per JEITA RCR-9102B.
- 4) All parameters are specified at 25°C ambient temperature unless otherwise indicated.

PJH Open Frame Power Supply

24V, 36V Output

PJH

HIGHLIGHTS & FEATURES

- Household appliance approval for pollution degree 3 to IEC/EN 60335-1, IEC/EN 61558-1 and IEC/EN 61558-2-16
- Available for Class I or Class II (double isolation) configuration with universal AC input voltage range
- 300W with fan cooled and up to 240W convection cooled
- Standard industrial footprint of 3" x 5"
- Built-in active PFC, remote ON/OFF, remote sense, power good signal
- No load input power consumption < 0.5W and low earth leakage current < 0.75mA
- Extreme low temperature cold start at -40°C

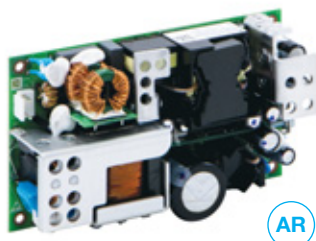

GENERAL SPECIFICATIONS

	COMING SOON	COMING SOON	COMING SOON	COMING SOON
OUTPUT	PJH-24V300WBB□	PJH-24V300WBC□	PJH-36V300WBB□	PJH-36V300WBC□
Output Voltage	V1: 24V, V _{SB} : 5V	V1: 24V, V _{SB} : 12V	V1: 36V, V _{SB} : 5V	V1: 36V, V _{SB} : 12V
Output Voltage Range	V1: ± 5%, V _{SB} : ± 5%	V1: ± 5%, V _{SB} : ± 5%	V1: ± 5%, V _{SB} : ± 5%	V1: ± 5%, V _{SB} : ± 5%
Output Current	V1: 0-12.5A V _{SB} : 0-1.2A	V1: 0-12.5A V _{SB} : 0-0.5A	V1: 0-8.33A V _{SB} : 0-1.2A	V1: 0-8.33A V _{SB} : 0-0.5A
Output Power	300W	300W	300W	300W
Line Regulation	< 0.5% (@ 90-264Vac input, 0-100% load)			
Load Regulation	< 1.0% (@ 90-264Vac input, 0-100% load)			
PARD (20MHz)	V1: < 240mVpp, V _{SB} : < 120mVpp		V1: < 360mVpp, V _{SB} : < 120mVpp	
Hold-up Time	> 12ms @ 115Vac & 230Vac			
INPUT				
Phase Input	Single Phase			
Input Voltage Range	90-264Vac			
Input Frequency	47-63Hz			
Input Current	< 4.0A @ 100Vac			
Efficiency ¹⁾ at 100% Load	> 93.0% @ 115Vac, > 94.0% @ 230Vac			
Max Inrush Current (Cold Start)	< 20A @ 115Vac, < 40A @ 230Vac			
Power Factor	> 0.95 @ 115Vac & 230Vac			
Leakage Current	< 0.75mA @ 240Vac			
MECHANICAL				
Case Cover / Chassis	-			
Dimensions (L x W x H)	127 x 76.2 x 31.7 mm (5.00" x 3.00" x 1.25")	127 x 76.2 x 31.7 mm (5.00" x 3.00" x 1.25")	127 x 76.2 x 31 mm (5.00" x 3.00" x 1.22")	127 x 76.2 x 31 mm (5.00" x 3.00" x 1.22")
Unit Weight	0.45 kg (0.99 lb)	0.45 kg (0.99 lb)	0.45 kg (0.99 lb)	0.45 kg (0.99 lb)
Cooling System	Convection: 0-240W Forced Air: 241-300W	Convection: 0-240W Forced Air: 241-300W	Convection: 0-240W Forced Air: 241-300W	Convection: 0-240W Forced Air: 241-300W
MTBF ²⁾	> 700,000 hrs	> 700,000 hrs	> 700,000 hrs	> 700,000 hrs
ENVIRONMENT				
Operating Temperature	-25°C to +70°C			
Storage Temperature	-40°C to +85°C			
Power De-rating	Convection: > 45°C (4.6W / °C) for orientation A, D; > 50°C (5.75W / °C) for orientation B Forced Air: > 50°C (7.5W / °C)			
Operating Humidity	5 to 95% RH (Non-Condensing)			
Operating Altitude	0 to 5,000 m (0 to 16,400 ft)			

Dimensions Reference

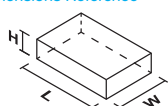

Notes

- 1) At 25°C ambient temperature.
- 2) MTBF as per Telcordia SR-332 (I/P: 115Vac, O/P: 100% load).
- 3) All parameters are specified at 25°C ambient temperature unless otherwise indicated.

PJU Open Frame Power Supply

13.8V, 27.6V Output

PJU

HIGHLIGHTS & FEATURES

- Universal AC input voltage range
- Zero switch over time from loss of AC to battery operation
- Protection against reverse polarity battery connection
- Built-in diagnostic monitoring for AC OK and Battery Low status
- Overvoltage / Overcurrent / Over Temperature / Short Circuit Protections
- Built-in over current and short circuit protection in Buffering (battery discharging) mode operation



AR

GENERAL SPECIFICATIONS

	NEW	NEW	NEW	NEW
OUTPUT	PJU-13V60W□A□	PJU-13V60W□B□	PJU-27V60W□A□	PJU-27V60W□B□
Output Voltage	V1: 13.8V, B+: 13.6V	V1: 13.8V, B+: 13.6V	V1: 27.6V, B+: 27.4V	V1: 27.6V, B+: 27.4V
Output Voltage Range	V1: 13.52-14.07V	V1: 13.52-14.07V	V1: 27.04-28.00V	V1: 27.04-28.00V
Output Current	V1: 3.9A, B+: 0.4A	V1: 3.9A, B+: 0.4A	V1: 1.75A, B+: 0.4A	V1: 1.75A, B+: 0.4A
Output Power	60W	60W	60W	60W
Line Regulation				< 0.5%
Load Regulation				< 1.0%
PARD (20MHz)	< 100mVpp		< 150mVpp	
Hold-up Time	> 10ms @ 115Vac (100% load)			
INPUT				
Phase Input	Single Phase			
Input Voltage Range	90-264Vac			
Input Frequency	47-63Hz			
Input Current	< 1.2A @ 115Vac, < 0.7A @ 230Vac			
Efficiency ¹⁾ at 100% Load	> 86.0% @ 115Vac, > 87.0% @ 230Vac		> 88.0% @ 115Vac, > 89.0% @ 230Vac	
Max Inrush Current (Cold Start)	< 30A @ 115Vac, < 60A @ 230Vac			
Power Factor	Conform to EN 61000-3-2			
Leakage Current	< 1mA @ 240Vac			
MECHANICAL				
Case Cover / Chassis	SECC Steel			
Dimensions (L x W x H) ²⁾	101.6 x 50.8 x 30.6 mm (4.00" x 2.00" x 1.20")	101.6 x 50.8 x 30.6 mm (4.00" x 2.00" x 1.20")	101.6 x 50.8 x 30.6 mm (4.00" x 2.00" x 1.20")	101.6 x 50.8 x 30.6 mm (4.00" x 2.00" x 1.20")
Unit Weight ²⁾	0.13 kg (0.29 lb)	0.13 kg (0.29 lb)	0.13 kg (0.29 lb)	0.13 kg (0.29 lb)
Cooling System	Convection			
MTBF ³⁾	> 350,000 hrs	> 350,000 hrs	> 350,000 hrs	> 350,000 hrs
ENVIRONMENT				
Operating Temperature	-20°C to +70°C			
Storage Temperature	-40°C to +85°C			
Power De-rating	> 40°C (1.67% / °C) PJU-13V60WB□□: > 35°C (1.43% / °C)		> 40°C (1.67% / °C)	
Operating Humidity	5 to 95% RH (Non-Condensing)			
Operating Altitude	0 to 5,000 m (0 to 16,400 ft)			

Dimensions Reference

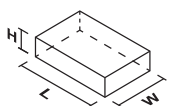

Notes

- 1) At 25°C ambient temperature.
- 2) Open frame (without chassis and cover).
- 3) MTBF as per Telcordia SR-332 (I/P: 115Vac & 230Vac, O/P: 100% load).
- 4) All parameters are specified at 25°C ambient temperature unless otherwise indicated.

Delta Industrial Power Supplies

DIN Rail Modules



AR

CliQ^{II}



Redundancy Modules

- Wide input and output range of 22-60Vdc
- Very wide operating temperature from -40°C to +80°C
- Built-in 2 channel DC OK signal and alarm relay contact
- Support N+1 Redundancy connection
- Conformal coating on PCBAs to protect against common dust and chemical pollutants
- Hazardous Locations approval to ATEX and Class I, Div 2
- IP20 Certified



AR

CliQ^{II}



Buffer Modules

- Minimum buffering time of:
 - 250ms @ 24V/20A for DRB-24V020AB□
 - 200ms @ 24V/40A for DRB-24V040ABN
- Flexible operating buffering voltage modes: Fixed mode at 22Vdc; Dynamic mode for Vin-1V
- Support parallel connection to extend buffering time
- Conformal coating on PCBAs to protect against common dust and chemical pollutants
- Hazardous Locations approval to ATEX and Class I, Div 2 for DRB-24V020ABA



AR

CliQ^{II}



DC-UPS Module

- Full corrosion resistant aluminium casing
- Suitable for 24V system up to 40A
- Built-in diagnostic monitoring for DC OK, Discharge and Battery Fail by relay contacts
- LED indicator for DC OK, Battery Charging, Battery Discharging, Battery Fail and Battery Reverse Polarity
- High MTBF > 500,000 hrs per Telcordia SR-332
- Conformal coating on PCBAs to protect against common dust and chemical pollutants



AR

CHROME



DC-UPS Module

- Suitable for 24V system up to 10A
- Zero switch over time from loss of DC input to battery operation
- Built-in diagnostic monitoring for DC OK, Discharge and Battery Fail by relay contacts
- Full power for the entire temperature range from -20°C to +60°C
- LED indicator for DC OK, Battery Charging, Battery Discharging, Battery Fail and Battery Reverse Polarity
- High MTBF > 500,000 hrs as per Telcordia SR-332

CliQ II DIN Rail Modules

Redundancy Modules



HIGHLIGHTS & FEATURES

- Wide input and output range of 22-60Vdc
- Very wide operating temperature from -40°C to +80°C
- Built-in 2 channel DC OK signal and alarm relay contact
- Support N+1 Redundancy connection
- Conformal coating on PCBAs to protect against common dust and chemical pollutants
- Hazardous Locations approval to ATEX and Class I, Div 2
- IP20 Certified

GENERAL SPECIFICATIONS

OUTPUT	DRR-20□	DRR-40□
Output Current	Normal mode = 0-20Amps; Short Circuit or Overload = 25Amps max	Normal mode = 0-40Amps; Short Circuit or Overload = 50Amps max
Voltage Drop ($V_{in} - V_{out}$)	Typical 0.65V	
INPUT		
Input Voltage Range	22-60Vdc	
Input Current	(1+1 Redundancy) = Nom. 2 x 12.5Amps (N+1 Redundancy) = Nom. 2 x 10Amps (Single use) = Nom. 20Amps	(1+1 Redundancy) = Nom. 2 x 25Amps (N+1 Redundancy) = Nom. 2 x 20Amps (Single use) = Nom. 40Amps
MECHANICAL		
Case Cover / Chassis	Aluminium	
Dimensions (L x W x D)	121 x 50 x 122.1 mm (4.76" x 1.97" x 4.81")	121 x 50 x 122.1 mm (4.76" x 1.97" x 4.81")
Unit Weight	0.38 kg (0.84 lb)	0.52 kg (1.15 lb)
Cooling System	Convection	
LED Indicators	Green LED DC OK: $V_{in,1}$ and $V_{in,2}$	
MTBF ¹⁾	> 800,000 hrs	> 800,000 hrs
ENVIRONMENT		
Operating Temperature	-40°C to +80°C	
Storage Temperature	-40°C to +85°C	
Power De-rating	> 50°C (2.5% / °C)	
Operating Humidity	5 to 95% RH (Non-Condensing)	
Operating Altitude	0 to 2,500 m (0 to 8,200 ft)	

Dimensions Reference

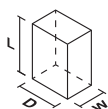

Notes

- 1) MTBF as per Telcordia SR-332 (Confidence level: 90%, I/P: 24Vdc, O/P: 100% load) for vertical mounting orientation.
- 2) All parameters are specified at 25°C ambient temperature unless otherwise indicated.

CliQ II DIN Rail Modules

Buffer Modules



HIGHLIGHTS & FEATURES

- Minimum buffering time of:
 - 250ms @ 24V/20A for DRB-24V020AB□
 - 200ms @ 24V/40A for DRB-24V040ABN
- Flexible operating buffering voltage modes:
 - Fixed mode at 22Vdc
 - Dynamic mode for $V_{in} - 1V$
- Support parallel connection to extend buffering time
- Conformal coating on PCBAs to protect against common dust and chemical pollutants
- Hazardous Locations approval to ATEX and Class I, Div 2 (DRB-24V020ABA)

GENERAL SPECIFICATIONS

OUTPUT	DRB-24V020AB□	DRB-24V040ABN
Output Voltage	24Vdc typ. (Depends on V_{in})	24Vdc typ. (Depends on V_{in})
Output Voltage Range	22-28V (Switch = "Fix 22V" buffering starts if terminal voltage falls below 22V) (Switch = " $V_{in} - 1V$ " buffering starts if terminal voltage is decreased by more than 1V)	
Output Current	20.0A Max	40.0A Max
PARD (20MHz)	< 200mVpp, Buffering Mode	< 350mVpp, Buffering Mode
Buffer Time	> 250ms @ 24V/20A load, > 5s @ 24V/1A load	> 200ms @ 24V/40A load, > 8s @ 24V/1A load
INPUT		
Input Voltage Range	22.8-28.8Vdc	
Input Current	Charging Mode: < 0.6A	Charging Mode: < 0.6A
Input Power	2.5W average (Standby Mode)	
Charging Time	< 30s	< 40s
Polarity Protection	Yes	Yes
MECHANICAL		
Case Cover / Chassis	Aluminium	Aluminium
Dimensions (L x W x D)	121 x 70 x 120.1 mm (4.76" x 2.76" x 4.73")	121 x 70 x 120.1 mm (4.76" x 2.76" x 4.73")
Unit Weight	0.76 kg (1.68 lb)	0.90 kg (1.98 lb)
Cooling System	Convection	
LED Indicators	Green LED Off = Unit is discharged or $V_{in} < 22Vdc$ Green LED On = Unit is fully charged (Ready) Green LED Flashing Slowly (1Hz) = Unit is charging Green LED Flashing Quickly (10Hz) = Unit is discharging (Buffering)	
MTBF ¹⁾	> 800,000 hrs	> 800,000 hrs
SAFETY / ENVIRONMENT		
Operating Temperature	-25°C to +75°C	
Storage Temperature	-25°C to +85°C	
Power De-rating	> 70°C (5% / °C)	
Operating Humidity	5 to 95% RH (Non-Condensing)	
Operating Altitude	0 to 2,500 m (0 to 8,200 ft)	

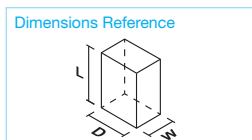

Notes

- 1) MTBF as per Telcordia SR-332 (Confidence level: 90%, I/P: 24Vdc, O/P: 100% load) for vertical mounting orientation.
- 2) All parameters are specified at 25°C ambient temperature unless otherwise indicated.

CliQ II DIN Rail Modules

DC-UPS Module



AR



HIGHLIGHTS & FEATURES

- Full corrosion resistant aluminium casing
- Suitable for 24V system up to 40A
- Built-in diagnostic monitoring for DC OK, Discharge and Battery Fail by relay contacts
- LED indicator for DC OK, Battery Charging, Battery Discharging, Battery Fail and Battery Reverse Polarity
- High MTBF > 500,000 hrs per Telcordia SR-332
- Conformal coating option on PCBAs to protect against common dust and chemical pollutants

GENERAL SPECIFICATIONS

OUTPUT	DRU-24V40ABN
Output Voltage Range	23-28Vdc
Output Current	40.0A Max
Output Power	960W Max
INPUT	
Input Voltage Range	24-28Vdc
Input Current	Charging Mode: 2.0A ± 1.0A
Charging Time	< 3hr ± 1 hr (for battery 24V/15AH)
Efficiency	Charging Mode: > 70.0% Buffering Mode: > 99.0%
MECHANICAL	
Case Cover / Chassis	Aluminium
Dimensions (L x W x D)	121 x 50 x 117.3 mm (4.76" x 1.97" x 4.62")
Unit Weight	0.60 kg (1.32 lb)
Cooling System	Convection
LED Indicators	Green LED ON = Battery is fully charged Green LED Flashing = Battery is charging Orange LED ON = Battery 24V or DC 24V reverse polarity Orange LED Flashing = Battery is discharging Red LED ON = Battery fail (no battery is connected)
MTBF ¹⁾	> 500,000 hrs
ENVIRONMENT	
Operating Temperature	-20°C to +60°C
Storage Temperature	-40°C to +85°C
Operating Humidity	5 to 95% RH (Non-Condensing)
Operating Altitude	0 to 3,000 m (0 to 9,840 ft)

Dimensions Reference

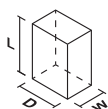

Notes

- 1) MTBF as per Telcordia SR-332 (Confidence level: 90%, I/P: 24Vdc, O/P: 100% load) for vertical mounting orientation.
- 2) All parameters are specified at 25°C ambient temperature unless otherwise indicated.

Chrome DIN Rail Module

DC-UPS Module



CHROME



AR

HIGHLIGHTS & FEATURES

- Suitable for 24V system up to 10A
- Zero switch over time from loss of DC input to battery operation
- Built-in diagnostic monitoring for DC OK, Discharge and Battery Fail by relay contacts
- Full power for the entire temperature range from -20°C to +60°C
- LED indicator for DC OK, Battery Charging, Battery Discharging, Battery Fail and Battery Reverse Polarity
- High MTBF > 500,000 hrs as per Telcordia SR-332

GENERAL SPECIFICATIONS

OUTPUT	DRU-24V10ACZ
Output Voltage Range	23-28Vdc
Output Current	10.0A Max
Output Power	240W Max
INPUT	
Input Voltage Range	24-28Vdc
Input Current	Charging Mode: 0.5A ± 0.1A
Charging Time	< 25hr ± 5 hr (for battery 24V/12AH)
Efficiency	Charging Mode: > 70.0% Buffering Mode: > 99.0%
MECHANICAL	
Case Cover / Chassis	Plastic
Dimensions (L x W x D)	91 x 71 x 55.6 mm (3.58" x 2.80" x 2.19")
Unit Weight	0.14 kg (0.31 lb)
Cooling System	Convection
LED Indicators	Green LED ON = Battery is fully charged Green LED Flashing = Battery is charging Orange LED ON = Battery 24V or DC 24V reverse polarity Orange LED Flashing = Battery is discharging Red LED ON = Battery fail (no battery is connected)
MTBF ¹⁾	> 500,000 hrs
ENVIRONMENT	
Operating Temperature	-20°C to +60°C
Storage Temperature	-40°C to +85°C
Operating Humidity	5 to 95% RH (Non-Condensing)
Operating Altitude	0 to 3,000 m (0 to 9,840 ft)

Dimensions Reference

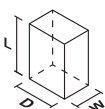

Notes

- 1) MTBF as per Telcordia SR-332 (Confidence level: 90%, I/P: 24Vdc, O/P: 100% load) for vertical mounting orientation.
- 2) All parameters are specified at 25°C ambient temperature unless otherwise indicated.

Standard Products

Delta Medical Power Supplies



Product Types

1 Enclosed

All Medical Enclosed Power Supplies are certified with both medical and ITE safety approvals. Encased in strong metal casing, the series of versatile products can be used in a wide variety of equipment for medical and industrial applications.



2 Open Frame

The Medical Open Frame provides high performance and reliable solution as an internal power supply for various types of medical equipment.



3 ATX

Highly reliable design with ATX standard form factor and output cable pin-outs. Certified with medical standards and suitable for use in medical devices with Type BF classification.



4 Configurable

The MEG configurable power supply is designed for use in both medical and industrial applications. It supports up to 6 isolated output. The products can be configured for output voltages ranging from 2Vdc to 60Vdc.



5 Adapter

The Medical Adapter rides on Delta's market leading adapter technology to provide the same high quality external power supplies for medical systems and equipments.



Selection Guide

Delta Medical Power Supplies

New products are frequently introduced. Please visit www.DeltaPSU.com for latest product updates.

Product Type	Series	Model Name	CC Code	Input Terminal	Output Voltage	Output Current	Output Power	Page
Enclosed Power Supply	MDS	MDS-200ADB12	AA	Molex 2-pin	12V	16.67A	200W	77
		MDS-250ADB12	AA	Molex 2-pin		20.84A	250W	
		MDS-300ADB12	AA	Molex 2-pin		25.0A	300W	
		MDS-400ADB12	AA	Molex 2-pin		33.33A	400W	
		MDS-300ADB18	AA	Molex 2-pin	18V	16.66A	300W	78
		MDS-200ADB24	A	Molex 2-pin	24V	8.33A	200W	
		MDS-250ADB24	AA	Molex 2-pin		10.41A	250W	
		MDS-300ADB24	AA	Molex 2-pin		12.5A	300W	
		MDS-400ADB24	AA	Molex 2-pin		16.67A	400W	
		MDS-300ADB48	AA	Molex 2-pin	48V	6.25A	300W	
MEB	<ul style="list-style-type: none"> Intelligent Fan Speed Control PMBus Ver 1.3 Supported 	MEB-1K2A24T	AAA	DINKLE 3-pin	24V	50.0A	1200W	79
		MEB-1K2A48T	AAA	DINKLE 3-pin	48V	25.0A	1200W	
Open Frame Power Supply	MDS	MDS-040APS12 B	A	JST 2-pin	12V	3.33A	40W	81
		MDS-065APS12 B	A	JST 2-pin		5.42A	65W	
		MDS-100APS12 B	A	JST 2-pin		8.33A	100W	
		MDS-100BPS12 B	A	JST 2-pin		8.33A	100W	

Medical Power Supply Model Numbering

MDS -	XXX	□	□	□	□	□□
Delta Medical Power Supply MDS-200A series MDS-250A series MDS-300A series MDS-400A series	Max power wattage in the product series. May be lower at some voltages. 200 - 200W 250 - 250W	Family Code A	Product Type D - Enclosed P - Open Frame	Input Type A, C, E, G - Class II 2-pin connector B, D, F, H - Class I 3-pin connector	Output Voltage 12 - 12V 24 - 24V	CC Code For DC connector, label, etc. A - DC connector type ¹⁾

ME	B -	XXX	□	□□	□	□□□
Delta Medical Power Supply	B - Enclosed	Max power wattage in the product series. May be lower at some voltages. 1K2 - 1,200W	Family Code A	Output Voltage 24 - 24V	Inlet Type T - Terminal	CC Code

MDS -	XXX	□	□	□	□	□	□
Delta Medical Power Supply MDS-040APS series MDS-065APS series MDS-100APS series MDS-100BPS series MDS-400AUS series	Max power wattage in the product series. May be lower at some voltages. 040 - 40W 065 - 65W	Family Code A - Family A B - Family B	Product Type P - Open Frame U - U Frame	Input Type Code S - Single Output	Output Voltage 12 - 12V 24 - 24V	Input Configuration B - Class I 3-pin connector A - Class II 2-pin connector	CC Code For DC connector, label, etc. A - DC connector ¹⁾

1) Refer to technical datasheet or product catalog

Product Type	Series	Model Name	CC Code	Input Terminal	Output Voltage	Output Current	Output Power	Page
Open Frame Power Supply	MDS	MDS-200APB12*	AA	Molex 2-pin	12V	16.67A	200W	82
		MDS-250APB12*	AA	Molex 2-pin		20.84A	250W	
		MDS-300APB12*	AA	Molex 2-pin		25.0A	300W	
		MDS-400APB12*	AA	Molex 2-pin		33.33A	400W	
		MDS-040APS15 B	A	JST 2-pin	15V	2.67A	40W	83
		MDS-065APS15 B	A	JST 2-pin		4.2A	65W	
		MDS-100APS15 B	A	JST 2-pin		6.67A	100W	
		MDS-100BPS15 B	A	JST 2-pin		6.7A	100W	
		MDS-040APS18 B	A	JST 2-pin	18V	2.22A	40W	84
		MDS-065APS18 B	A	JST 2-pin		3.61A	65W	
		MDS-100APS18 B	A	JST 2-pin		5.55A	100W	
		MDS-100BPS18 B	A	JST 2-pin		5.5A	100W	
		MDS-300APB18*	AA	Molex 2-pin		16.66A	300W	
		MDS-400AUS19 B	A	DECA 3-pin	19V	21.1A	400W	85
		MDS-400AUS24 B	A	DECA 3-pin	24V	16.67A	400W	86
		MDS-040APS24 B	A	JST 2-pin	24V	1.67A	40W	
		MDS-065APS24 B	A	JST 2-pin		2.71A	65W	
		MDS-100APS24 B	A	JST 2-pin		4.17A	100W	
		MDS-100BPS24 B	A	JST 2-pin		4.2A	100W	
		MDS-200APB24*	AA	Molex 2-pin	48V	8.33A	200W	87
	MDS-250APB24*	AA	Molex 2-pin	10.41A		250W		
	MDS-300APB24*	AA	Molex 2-pin	12.5A		300W		
	MDS-400APB24*	AA	Molex 2-pin	16.66A		400W		
	MDS-300APB48*	AA	Molex 2-pin	6.25A		300W		
	MDS-100AP401 B	A	Molex 2-pin	5.1V/12V/-15V/15V	8A/3A/0.8A/0.8A	100W	88	
	MEP	MEP-25A15J	BNA	JWT 2-pin	15V	1.67A	25W	89
	MEU	MEU-600C24T	AAA	DINKLE 3-pin	24V	25.0A	600W	90
AAA			DINKLE 3-pin	48V	12.5A	600W		

* Product with options for enclosed or U-Frame

Medical Power Supply Model Numbering

MDS -	XXX	□	□	□	□	□
Delta Medical Power Supply MDS-100AP401	Max power wattage in the product series. May be lower at some voltages. 100 - 100W	Family Code A	Product Type P - Open Frame	Output Voltage 401 - 5.1V, 12V, -15V, 15V	Input Configuration B - Class I with PE connection	CC Code For DC connector, label, etc. A - DC connector ¹⁾

1) Refer to technical datasheet or product catalog

ME	P -	XX	□	□	□	□□□
Delta Medical Power Supply	P - Open Frame	Max power wattage in the product series. May be lower at some voltages. 25 - 25W	Family Code A	Output Voltage 15 - 15V	Input Connector J - Harness	CC Code

ME	U -	XXX	□	□	□	□□□
Delta Medical Power Supply	U - U Frame	Max power wattage in the product series. May be lower at some voltages. 600 - 600W	Family Code C - Family C	Output Voltage 24 - 24V 48 - 48V	Inlet Type T - Terminal	CC Code

Selection Guide

Delta Medical Power Supplies

New products are frequently introduced. Please visit www.DeltaPSU.com for latest product updates.

Product Type	Series	Model Name	CC Code	AC Inlet	Output Voltage	Output Current	Output Power	Page
ATX Power Supply	MDS	MDS-350AD701	AA	C14	+3.3V, +5V, +5V _{SB} , +12V ₁ , +12V ₂ , -12V, -5V	8A, 9A, 1.25A, 8A, 8A, 0.25A, 0.1A	350W	93

Product Type	Series	Model Name	Output Slots	Output Voltage	Output Power	Page
Configurable Power Supply	MEG • PMBus Ver 1.3 Supported • IT & Medical safety approvals	MEG-1K2A4	4 Slots	Single Output: 2V-60V	1,200W	95
		MEG-2K1A6	6 Slots		2,100W	

Product Type	Series	Model Name	CC Code	AC Inlet	Output Voltage	Output Current	Output Power	Page
Adapter	MDS	MDS-005AAS05 A	R	Wall mount-China type	5V	1.00A	5W	97
		MDS-005AAS05 B	R	Wall mount-Japan, USA type		1.00A	5W	
		MDS-005AAS05 C	R	Wall mount-EU type		1.00A	5W	
		MDS-030AAC05*		Duck Head		3.00A	15W	
		MDS-005AAS06 A	R	Wall mount-China type	6V	0.83A	5W	98
		MDS-005AAS06 B	R	Wall mount-Japan, USA type		0.83A	5W	
		MDS-005AAS06 C	R	Wall mount-EU type		0.83A	5W	
		MDS-030AAC07*		Duck Head	7V	3.00A	21W	
		MDS-030AAC12*		Duck Head	12V	2.00A	24W	
		MDS-060AAS12 B	A	C14		5.00A	60W	
		MDS-060BAS12 A	B	C8		5.00A	60W	
		MDS-080AAS12 A		C8		6.66A	80W	
		MDS-150AAS12 B	A	C14		10.00A	120W	

* Please refer to technical datasheet to get detailed information

Medical Power Supply Model Numbering

MDS -	XXX	□	□	□	□□
Delta Medical Power Supply MDS-350AD701	Max power wattage in the product series. May be lower at some voltages. 350 - 350W	Family Code A	Product Type D - Enclosed	Output Voltage 701 - +3.3V, +5V, +5V _{SB} , +12V ₁ , +12V ₂ , -12V, -5V	CC Code

ME	G -	XXX	A	□
Delta Medical Power Supply	G - Configurable	Max power wattage in the product series. May be lower at some voltages. 1K2 - 1,200W 2K1 - 2,100W	Family Code A	Slot Number 4 - 4 Slots 6 - 6 Slots

MDS -	XXX	□	□	□	□	□	□□
Delta Medical Power Supply MDS-005AAS series MDS-060AAS series MDS-060BAS series MDS-080AAS series MDS-090AAS series MDS-090BAS series MDS-150AAS series	Max power wattage in the product series. May be lower at some voltages. 005 - 5W 060 - 60W	Family Code A - Family A B - Family B	Product Type A - Adapter	# of Output S - Single Output	Output Voltage 12 - 12V 24 - 24V	Input Configuration A - C8 B - C14 C - NA A - CN B - US C - EU for 005AAS	CC Code For DC plug, cable length, label, etc.

Product Type	Series	Model Name	CC Code	AC Inlet	Output Voltage	Output Current	Output Power	Page
Adapter	MDS	MDS-030AAC15*		Duck Head	15V	2.00A	30W	99
		MDS-060AAS15 B	A	C14		4.00A	60W	
		MDS-090AAS15 B	A	C14		6.00A	90W	
		MDS-060AAS19 B	A	C14	19V	3.20A	60W	100
		MDS-060BAS19 A	A	C8		3.15A	60W	
		MDS-090AAS19 B	A	C14		4.74A	90W	
		MDS-150AAS19 B	A	C14		7.89A	150W	
		MDS-150CAB19	AA	C6		7.90A	150W	
		MDS-030AAC24*		Duck Head	24V	1.25A	30W	101
		MDS-060AAS24 B	A	C14		2.50A	60W	
		MDS-060BAS24 A	A	C8		2.50A	60W	
		MDS-090AAS24 B	A	C14		3.75A	90W	
		MDS-090BAS24 A	B	C8	3.75A	90W	102	
	MDS-150AAS24 B	A	C14	6.25A	150W			
	MEA • Efficiency Level VI • 2 x MOPP isolation	MEA-120A15B	G-A	C8	15V	8.0A	120W	103
		MEA-250A24C	H-A	C14	24V	10.42A	250W	
	MEF • IP22 ingress protection rating • 2 x MOPP isolation	MEF-010A05B	J-A	Wall mount-US type	5V	2.0A	5W	104

* Please refer to technical datasheet to get detailed information

Medical Power Supply Model Numbering

MDS –	XXX	□	□	□	□□	□□
Delta Medical Power Supply MDS-150CAB19A	Max power wattage in the product series. May be lower at some voltages. 150 - 150W	Family Code C	Product Type A - Adapter	Input Connector Type A, C, E, G - Class II C8/C18 B, D, F, H - Class I C6/C14	Output Voltage 19 - 19V	CC Code AA-ZX Power cord length, plug, label, etc.
MDS –	XXX	AAC	□	□		□
Delta Medical Power Supply MDS-030 series	Max power wattage in the product series. May be lower at some voltages. 030 - 30W	Family Code	Output Voltage (Single Output) 05 - 5V 07 - 7V 12 - 12V 15 - 15V ¹⁾ 24 - 24V	CC Code DC plug type and output cable length A - 2.1 × 5.5 × 10 mm DC plug, and 1200 mm cable length B - 2.1 × 5.5 × 12 mm DC plug, and 1200 mm cable length ²⁾	CC Code Country Duck Head Type A - China B - United States ²⁾ C - European ²⁾ D - United Kingdom ²⁾ E - Australia ²⁾ G - Korea ²⁾ H - India ²⁾ J - Argentina ²⁾ K - Brazil ²⁾ M - South Africa ²⁾	

1) MDS-030AAC15 BB is not available

2) Options

ME	A –	XXX	□	□□	□	□□
Delta Medical Power Supply	A - Desktop Adapter	Max power wattage in the product series. May be lower at some voltages. 120 - 120W 250 - 250W	Family Code A	Output Voltage 15 - 15V 24 - 24V	Input Connector Type B - Class II C8 C - Class I C14	CC Code For DC plug, cable length, label, etc.
ME	F –	XXX	□	□□	B	□□
Delta Medical Power Supply	F - Fixed	Max power wattage in the product series. May be lower at some voltages. 010 - 10W	Family Code A	Output Voltage 05 - 5V	Country Duck Head Type B - United States (2-pin)	CC Code For DC plug, cable length, label, etc.

Delta Medical Power Supplies

Enclosed Power Supply



AR

MDS



- Compliant with IEC 60601-1-2 4th Ed. requirements
- Suitable for type BF medical product
- Safety approvals for medical and IT applications
- Remote on/off control
- Power Good signal
- High MTBF > 500,000 hrs as per Telcordia SR-332



AR

MEB



- Full power from 90Vac to 264Vac, up to 50°C ambient
- Up to 500K hours MTBF
- 2 × MOPP isolation, Suitable for type BF medical products
- Current sharing and 5V/2A standby output
- Compliant with IEC 60601-1-2 4th Ed. Requirements
- PMBus Ver 1.3 supported
- Intelligent fan speed control

MDS Enclosed Power Supply

12V, 18V Output

MDS

HIGHLIGHTS & FEATURES

- Universal AC input voltage range
- Safety approvals for medical and IT applications
- Compliant with IEC 60601-1-2 4th Ed. Requirements
- Class B EMI; 4th Edition Immunity Compliance
- Suitable for type BF medical product
- 2 × MOPP isolation
- Power Good signal



GENERAL SPECIFICATIONS

OUTPUT	MDS-200ADB12	MDS-250ADB12	MDS-300ADB12	MDS-400ADB12	MDS-300ADB18
Output Voltage	12V	12V	12V	12V	18V
Output Current (Max)	9.17A (Convection) 16.67A (with 8.5CFM Forced Air)	12.5A (Convection) 20.84A (with 10CFM Forced Air)	15.83A (Convection) 25.0A (with 10CFM Forced Air)	33.33A (with 20CFM Forced Air)	10.55A (Convection) 16.66A (with 10CFM Forced Air)
Output Power	110W (Convection) 200W (with 8.5CFM Forced Air)	150W (Convection) 250W (with 10CFM Forced Air)	190W (Convection) 300W (with 10CFM Forced Air)	400W (with 20CFM Forced Air)	190W (Convection) 300W (with 10CFM Forced Air)
Load Regulation	± 1%				
Ripple & Noise	1% typ. pk-pk Vrated @ Full load			150mV pk-pk Vrated @ Full load	1% typ. pk-pk Vrated @ Full load
INPUT					
Input Voltage Range	90-264Vac				
Input Frequency	47-63Hz				
Efficiency	91.0% typ. @ 115Vac/60Hz, 93.0% typ. @ 230Vac/50Hz	89.45% typ. @ 115Vac/60Hz, 90.5% typ. @ 230Vac/50Hz	91.3% typ. @ 115Vac/60Hz, 92.6% typ. @ 230Vac/50Hz	89.5% typ. @ 115Vac/60Hz, 91.5% typ. @ 230Vac/50Hz	92.5% typ. @ 115Vac/60Hz, 93.5% typ. @ 230Vac/50Hz
Leakage Current ¹⁾ (264Vac)	Input-PE: < 0.1mA @ NC, < 0.3mA @ SFC Output-PE: < 0.1mA @ NC, < 0.5mA @ SFC				
MECHANICAL					
Dimensions (L × W × H)	113.9 × 64.7 × 44.7 mm (4.48" × 2.55" × 1.76")	140 × 88.9 × 44.4 mm (5.51" × 3.50" × 1.75")	140 × 88.9 × 44.4 mm (5.51" × 3.50" × 1.75")	140 × 88.9 × 44.4 mm (5.51" × 3.50" × 1.75")	140 × 88.9 × 44.4 mm (5.51" × 3.50" × 1.75")
Unit Weight	0.35 kg (0.76 lb)	0.61 kg (1.35 lb)	0.61 kg (1.35 lb)	0.61 kg (1.35 lb)	0.61 kg (1.35 lb)
MTBF ²⁾	800,000 hrs	500,000 hrs	800,000 hrs	500,000 hrs	800,000 hrs
EMC & Emissions	EN 55011/EN 55032, FCC Title 47: Class B				
ENVIRONMENT					
Operating Temperature	-10°C to +70°C				
Storage Temperature	-40°C to +85°C				
Operating Humidity	5 to 95% RH (Non-Condensing)				
Operating Altitude	0 to 5,000 m (0 to 16,400 ft)				
MEDICAL RATING					
Float Rating	BF				
MOPP	2 × MOPP				

Dimensions Reference

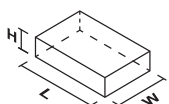

Notes

- 1) NC: normal condition, SFC: single fault condition.
- 2) MTBF as per Telcordia SR-332 (I/P: 115Vac, O/P: Load at Convection Air Flow, Ta: 35°C).
For MDS-400ADB12, MTBF as per Telcordia SR-332 (I/P: 115Vac, O/P: 100% load with 20CFM Forced Air, Ta: 35°C).

MDS Enclosed Power Supply

24V, 48V Output

MDS

HIGHLIGHTS & FEATURES

- Universal AC input voltage range
- Safety approvals for medical and IT applications
- Compliant with IEC 60601-1-2 4th Ed. Requirements
- Class B EMI; 4th Edition Immunity Compliance
- Suitable for type BF medical product
- 2 × MOPP isolation
- Power Good signal



GENERAL SPECIFICATIONS

OUTPUT	MDS-200ADB24	MDS-250ADB24	MDS-300ADB24	MDS-400ADB24	MDS-300ADB48
Output Voltage	24V	24V	24V	24V	48V
Output Current (Max)	5.0A (Convection) 8.33A (with 5.5CFM Forced Air)	5.62A (Convection) 10.41A (with 10CFM Forced Air)	8.75A (Convection) 12.5A (with 10CFM Forced Air)	16.67A (with 16CFM Forced Air)	4.375A (Convection) 6.25A (with 10CFM Forced Air)
Output Power	120W (Convection) 200W (with 5.5CFM Forced Air)	150W (Convection) 250W (with 10CFM Forced Air)	210W (Convection) 300W (with 10CFM Forced Air)	400W (with 16CFM Forced Air)	210W (Convection) 300W (with 10CFM Forced Air)
Load Regulation	± 1%				
Ripple & Noise	1% typ. pk-pk Vrated @ Full load				
INPUT					
Input Voltage Range	90-264Vac				
Input Frequency	47-63Hz				
Efficiency	92.0% typ. @ 115Vac/60Hz, 93.0% typ. @ 230Vac/50Hz	91.85% typ. @ 115Vac/60Hz, 92.98% typ. @ 230Vac/50Hz	93.0% typ. @ 115Vac/60Hz, 94.0% typ. @ 230Vac/50Hz	92.0% typ. @ 115Vac/60Hz, 93.0% typ. @ 230Vac/50Hz	92.5% typ. @ 115Vac/60Hz, 93.5% typ. @ 230Vac/50Hz
Leakage Current ¹⁾ (264Vac)	Input-PE: < 0.1mA @ NC, < 0.3mA @ SFC Output-PE: < 0.1mA @ NC, < 0.5mA @ SFC				
MECHANICAL					
Dimensions (L × W × H)	113.9 × 64.7 × 44.7 mm (4.48" × 2.55" × 1.76")	140 × 88.9 × 44.4 mm (5.51" × 3.50" × 1.75")	140 × 88.9 × 44.4 mm (5.51" × 3.50" × 1.75")	140 × 88.9 × 44.4 mm (5.51" × 3.50" × 1.75")	140 × 88.9 × 44.4 mm (5.51" × 3.50" × 1.75")
Unit Weight	0.35 kg (0.76 lb)	0.61 kg (1.35 lb)	0.61 kg (1.35 lb)	0.61 kg (1.35 lb)	0.61 kg (1.35 lb)
MTBF ²⁾	800,000 hrs	500,000 hrs	800,000 hrs	500,000 hrs	800,000 hrs
EMC & Emissions	EN 55011/EN 55032, FCC Title 47: Class B				
ENVIRONMENT					
Operating Temperature	-10°C to +70°C				
Storage Temperature	-40°C to +85°C				
Operating Humidity	5 to 95% RH (Non-Condensing)				
Operating Altitude	0 to 5,000 m (0 to 16,400 ft)				
MEDICAL RATING					
Float Rating	BF				
MOPP	2 × MOPP				

Dimensions Reference

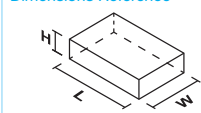

Notes

- 1) NC: normal condition, SFC: single fault condition.
- 2) MTBF as per Telcordia SR-332 (I/P: 115Vac, O/P: Load at Convection Air Flow, Ta: 35°C).
For MDS-400ADB24, MTBF as per Telcordia SR-332 (I/P: 115Vac, O/P: 100% load with 10CFM Forced Air, Ta: 35°C).

MEB Enclosed Power Supply

24V, 48V Output

MEB



HIGHLIGHTS & FEATURES

- Up to 1200W in 5" x 8.03" x 1.59" package
- Full power from 90Vac to 264Vac, up to 50°C ambient
- Up to 500K hours MTBF
- 2 x MOPP isolation, Suitable for type BF medical products
- Current sharing and 5V/2A standby output
- Class B Conducted and Radiated EMI
- Compliant with IEC 60601-1-2 4th Ed. Requirements
- PMBus Ver 1.3 supported
- Intelligent fan speed control

GENERAL SPECIFICATIONS

	NEW	
	MEB-1K2A24T	MEB-1K2A48T
OUTPUT		
Output Voltage	24V	48V
Output Current (Max)	50.0A	25.0A
Output Power	1200W	1200W
Load Regulation	2%	
Ripple & Noise	1% typ. pk-pk Vrated @ rated load	
INPUT		
Input Voltage Range	85-264Vac	
Input Frequency	47-63Hz	
Efficiency	90.0% typ. @ 115V/60Hz, 93.0% typ. @ 230V/50Hz	91.5% typ. @ 115V/60Hz, 94.0% typ. @ 230V/50Hz
Leakage Current ¹⁾ (264Vac)	Input-PE: < 0.3mA @ NC, < 1mA @ SFC Output-PE: < 0.1mA @ NC, < 0.5mA @ SFC	
MECHANICAL		
Dimensions (L x W x H)	204 x 127 x 40.5 mm (8.03" x 5.0" x 1.59")	204 x 127 x 40.5 mm (8.03" x 5.0" x 1.59")
Unit Weight	1.50 kg (3.30 lb)	1.50 kg (3.30 lb)
MTBF ²⁾	500,000 hrs	500,000 hrs
EMC & Emissions	EN 55011/EN 55032, FCC Title 47: Class B	
ENVIRONMENT		
Operating Temperature	-20°C to +70°C	
Storage Temperature	-40°C to +85°C	
Operating Humidity	5 to 95% RH (Non-Condensing)	
Operating Altitude	0 to 5,000 m (0 to 16,400 ft)	
MEDICAL RATING		
Float Rating	BF	
MOPP	2 x MOPP	

Dimensions Reference

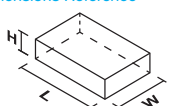

Notes

- 1) NC: normal condition, SFC: single fault condition.
- 2) MTBF as per Telcordia SR-332 (I/P: 115Vac, O/P: 100% load, Ta: 35°C).

Delta Medical Power Supplies

Open Frame Power Supply



AR

MDS



- Safety approvals for medical and IT applications
- Over-Voltage/Load/Temperature & Short Circuit Protections
- Low touch current (< 0.1mA Normal & < 0.3mA Single Fault)
- Compliant with IEC 60601-1-2 4th Ed. Requirements
- Power Good Signal, Remote Sense, Remote inhibit
- 2 × MOPP isolation



AR

MEP



- Safety approvals to medical and IT applications
- Compliant with IEC 60601-1-2 4th Ed. Requirements
- Low leakage current (< 70µA Normal & < 210µA Single Fault)
- Over-Voltage/Load/Temperature & Short Circuit protections
- 3 million hours MTBF
- 2 × MOPP isolation



AR

MEU



- Universal AC input
- Up to 500K hours MTBF
- 2 × MOPP isolation
- Safety approvals to medical and IT applications
- Compliant with IEC 60601-1-2 4th Ed. Requirements
- Over-Voltage/Load/Temperature & Short Circuit protections

MDS Open Frame Power Supply

12V Output

MDS

HIGHLIGHTS & FEATURES

- Universal AC input voltage
- Safety approvals for medical and IT applications
- Over-Voltage/Load/Temperature & Short Circuit Protections
- Low touch current (< 0.1mA Normal & < 0.3mA Single Fault)
- Compliant with IEC 60601-1-2 4th Ed. Requirements
- 2 × MOPP isolation
- High MTBF



GENERAL SPECIFICATIONS

OUTPUT	MDS-040APS12	MDS-065APS12	MDS-100APS12	MDS-100BPS12
Output Voltage	12V	12V	12V	12V
Output Current (Max)	3.33A	5.42A	8.33A	6.67A (Convection) 8.33A (with 10CFM Forced Air)
Output Power	40W	65W	100W	80W (Convection) 100W (with 10CFM Forced Air)
Load Regulation	± 1%			
Ripple & Noise	22.8mV pk-pk @ Full load	21.6mV pk-pk @ Full load	25mV pk-pk @ Full load	76mV pk-pk @ Full load
INPUT				
Input Voltage Range	90-264Vac			
Input Frequency	47-63Hz			
Efficiency	86.5% typ.	87.5% typ.	89.2% typ.	87.0% typ.
Touch Current ¹⁾ (264Vac)	< 0.1mA @ NC, < 0.3mA @ SFC			
Leakage Current ¹⁾ (264Vac)	-			
MECHANICAL				
Dimensions (L × W × H)	76.2 × 50.8 × 23 mm (3.00" × 2.00" × 0.91")	101.6 × 50.8 × 30 mm (4.00" × 2.00" × 1.18")	127 × 76.2 × 31 mm (5.00" × 3.00" × 1.22")	101.6 × 50.8 × 31.8 mm (4.00" × 2.00" × 1.25")
Unit Weight	0.08 kg (0.18 lb)	0.13 kg (0.29 lb)	0.21 kg (0.46 lb)	0.15 kg (0.33 lb)
MTBF ²⁾	3,000,000 hrs	2,500,000 hrs	3,000,000 hrs	1,000,000 hrs
EMC & Emissions	EN 55011/EN 55032, FCC Title 47: Class B			
ENVIRONMENT				
Operating Temperature	-10°C to +70°C			
Storage Temperature	-40°C to +85°C			
Operating Humidity	10 to 95% RH (Non-Condensing)			
Operating Altitude	0 to 3,000 m (0 to 9,840 ft)			0 to 5,000 m (0 to 16,400 ft)
MEDICAL RATING				
Float Rating	BF			
MOPP	2 × MOPP			

Dimensions Reference

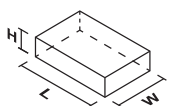

Notes

- 1) NC: normal condition, SFC: single fault condition.
- 2) MTBF as per Telcordia SR-332.

MDS Open Frame Power Supply

12V Output

MDS

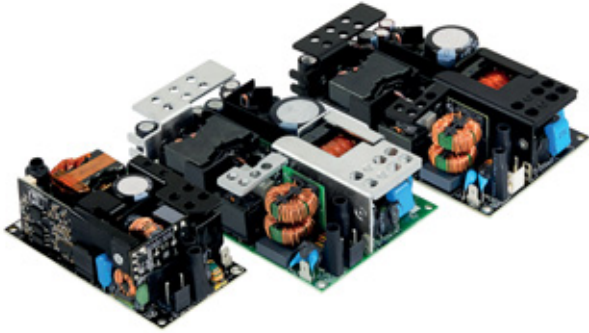

HIGHLIGHTS & FEATURES

- Universal AC input voltage range
- Safety approvals for medical and IT applications
- Compliant with IEC 60601-1-2 4th Ed. Requirements
- Class B EMI; 4th Edition Immunity Compliance
- Enclosed cover design option available
- Suitable for type BF medical product
- 2 × MOPP isolation
- Power Good signal

GENERAL SPECIFICATIONS

OUTPUT	MDS-200APB12	MDS-250APB12	MDS-300APB12	MDS-400APB12
Output Voltage	12V	12V	12V	12V
Output Current (Max)	10.83A (Convection) 16.67A (with 8.5CFM Forced Air)	12.5A (Convection) 20.84A (with 10CFM Forced Air)	18.33A (Convection) 25.0A (with 10CFM Forced Air)	33.33A (with 16CFM Forced Air)
Output Power	130W (Convection) 200W (with 8.5CFM Forced Air)	150W (Convection) 250W (with 10CFM Forced Air)	220W (Convection) 300W (with 10CFM Forced Air)	400W (with 16CFM Forced Air)
Load Regulation	± 2.5%	± 1%		
Ripple & Noise	1% typ. pk-pk Vrated @ Full load			150mV pk-pkV rated @ Full load
INPUT				
Input Voltage Range	90-264Vac			
Input Frequency	47-63Hz			
Efficiency	91.0% typ. @ 115Vac/60Hz, 93.0% typ. @ 230Vac/50Hz	89.45% typ. @ 115Vac/60Hz, 90.5% typ. @ 230Vac/50Hz	91.3% typ. @ 115Vac/60Hz, 92.6% typ. @ 230Vac/50Hz	89.5% typ. @ 115Vac/60Hz, 91.5% typ. @ 230Vac/50Hz
Leakage Current ¹⁾ (264Vac)	Input-PE: < 0.1mA @ NC, < 0.3mA @ SFC Output-PE: < 0.1mA @ NC, < 0.5mA @ SFC			
MECHANICAL				
Dimensions (L × W × H)	101.9 × 51.1 × 36.1 mm (4.01" × 2.01" × 1.42")	127.3 × 76.5 × 36.1 mm (5.01" × 3.01" × 1.42")	127.3 × 76.5 × 36.1 mm (5.01" × 3.01" × 1.42")	127.3 × 76.5 × 36.1 mm (5.01" × 3.01" × 1.42")
Unit Weight	0.20 kg (0.44 lb)	0.41 kg (0.90 lb)	0.41 kg (0.90 lb)	0.41 kg (0.90 lb)
MTBF ²⁾	800,000 hrs	500,000 hrs	800,000 hrs	500,000 hrs
EMC & Emissions	EN 55011/EN 55032, FCC Title 47: Class B			
ENVIRONMENT				
Operating Temperature	-10°C to +70°C			
Storage Temperature	-40°C to +85°C			
Operating Humidity	5 to 95% RH (Non-Condensing)			
Operating Altitude	0 to 5,000 m (0 to 16,400 ft)			
MEDICAL RATING				
Float Rating	BF			
MOPP	2 × MOPP			

Dimensions Reference

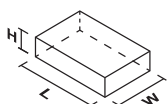

Notes

1) NC: normal condition, SFC: single fault condition.

2) MTBF as per Telcordia SR-332 (I/P: 115Vac, O/P: 100% load for Convection, Ta: 35°C).

For MDS-400APB12, MTBF as per Telcordia SR-332 (I/P: 115Vac, O/P: 100% load with 16CFM Forced Air, Ta: 35°C).

15V Output

MDS

HIGHLIGHTS & FEATURES

- Universal AC input voltage range
- Safety approvals for medical and IT applications
- Over-Voltage/Load/Temperature & Short Circuit Protections
- Low touch current (< 0.1mA Normal & < 0.3mA Single Fault)
- Compliant with IEC 60601-1-2 4th Ed. Requirements
- 2 × MOPP isolation
- High MTBF



GENERAL SPECIFICATIONS

OUTPUT	MDS-040APS15	MDS-065APS15	MDS-100APS15	MDS-100BPS15
Output Voltage	15V	15V	15V	15V
Output Current (Max)	2.67A	4.2A	6.67A	5.3A (Convection) 6.7A (with 10CFM Forced Air)
Output Power	40W	63W	100W	80W (Convection) 100W (with 10CFM Forced Air)
Load Regulation	± 1%			
Ripple & Noise	16.4mV pk-pk @ Full load	18mV pk-pk @ Full load	35.2mV pk-pk @ Full load	51.2mV pk-pk @ Full load
INPUT				
Input Voltage Range	90-264Vac			
Input Frequency	47-63Hz			
Efficiency	87.2% typ.	89.2% typ.	90.6% typ.	88.2% typ.
Touch Current ¹⁾ (264Vac)	< 0.1mA @ NC, < 0.3mA @ SFC			
Leakage Current ¹⁾ (264Vac)	< 0.15mA @ NC, < 0.3mA @ SFC			
MECHANICAL				
Dimensions (L × W × H)	76.2 × 50.8 × 23 mm (3.00" × 2.00" × 0.91")	101.6 × 50.8 × 30 mm (4.00" × 2.00" × 1.18")	127 × 76.2 × 31 mm (5.00" × 3.00" × 1.22")	101.6 × 50.8 × 31.8 mm (4.00" × 2.00" × 1.25")
Unit Weight	0.08 kg (0.18 lb)	0.13 kg (0.29 lb)	0.21 kg (0.46 lb)	0.15 kg (0.33 lb)
MTBF ²⁾	3,000,000 hrs	2,500,000 hrs	3,000,000 hrs	1,000,000 hrs
EMC & Emissions	EN 55011/EN 55032, FCC Title 47: Class B			
ENVIRONMENT				
Operating Temperature	-10°C to +70°C			
Storage Temperature	-40°C to +85°C			
Operating Humidity	10 to 95% RH (Non-Condensing)			
Operating Altitude	0 to 3,000 m (0 to 9,840 ft)			0 to 5,000 m (0 to 16,400 ft)
MEDICAL RATING				
Float Rating	BF			
MOPP	2 × MOPP			

Dimensions Reference

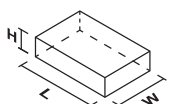

Notes

- 1) NC: normal condition, SFC: single fault condition.
- 2) MTBF as per Telcordia SR-332.

Enclosed Power Supply

Open Frame Power Supply

ATX Power Supply

Configurable Power Supply

Adapter

MDS Open Frame Power Supply

18V Output

MDS

HIGHLIGHTS & FEATURES

- Universal AC input voltage
- Safety approvals for medical and IT applications
- Over-Voltage/Load/Temperature & Short Circuit Protections
- Compliant with IEC 60601-1-2 4th Ed. Requirements
- Power Good signal, Remote Sense, Remote Inhibit (only MDS-300APB18)
- 2 × MOPP isolation



GENERAL SPECIFICATIONS

OUTPUT	MDS-040APS18	MDS-065APS18	MDS-100APS18	MDS-100BPS18	MDS-300APB18
Output Voltage	18V	18V	18V	18V	18V
Output Current (Max)	2.22A	3.61A	5.55A	4.4A (Convection) 5.5A (with 10CFM Forced Air)	12.22A (Convection) 16.66A (with 10CFM Forced Air)
Output Power	40W	65W	100W	80W (Convection) 100W (with 10CFM Forced Air)	220W (Convection) 300W (with 10CFM Forced Air)
Load Regulation	± 1%				
Ripple & Noise	14.8mV pk-pk @ Full load	20.8mV pk-pk @ Full load	28.8mV pk-pk @ Full load	88mV pk-pk @ Full load	1% typ. pk-pk Vrated @ Full load
INPUT					
Input Voltage Range	90-264Vac				
Input Frequency	47-63Hz				
Efficiency	86.9% typ.	87.7% typ.	91.24% typ.	87.6% typ.	92.5% typ. @ 115Vac/60Hz 93.5% typ. @ 230Vac/50Hz
Touch Current ¹⁾ (264Vac)	< 0.1mA @ NC, < 0.3mA @ SFC				-
Leakage Current ¹⁾ (264Vac)	< 0.15mA @ NC, < 0.3mA @ SFC				Input-PE: < 0.1mA @ NC, < 0.3mA @ SFC Output-PE: < 0.1mA @ NC < 0.5mA @ SFC
MECHANICAL					
Dimensions (L × W × H)	76.2 × 50.8 × 23 mm (3.00" × 2.00" × 0.91")	101.6 × 50.8 × 30 mm (4.00" × 2.00" × 1.18")	127 × 76.2 × 31 mm (5.00" × 3.00" × 1.22")	101.6 × 50.8 × 31.8 mm (4.00" × 2.00" × 1.25")	127.3 × 76.5 × 36.1 mm (5.01" × 3.01" × 1.42")
Unit Weight	0.08 kg (0.18 lb)	0.13 kg (0.29 lb)	0.21 kg (0.46 lb)	0.15 kg (0.33 lb)	0.41 kg (0.90 lb)
MTBF ²⁾	3,000,000 hrs	2,500,000 hrs	3,000,000 hrs	1,000,000 hrs	800,000 hrs
EMC & Emissions	EN 55011/EN 55032, FCC Title 47: Class B				
ENVIRONMENT					
Operating Temperature	-10°C to +70°C				
Storage Temperature	-40°C to +85°C				
Operating Humidity	10 to 95% RH (Non-Condensing)				5 to 95% RH (Non-Condensing)
Operating Altitude	0 to 3,000 m (0 to 9,840 ft)			0 to 5,000 m (0 to 16,400 ft)	
MEDICAL RATING					
Float Rating	BF				
MOPP	2 × MOPP				

Dimensions Reference

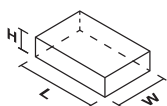

Notes

1) NC: normal condition, SFC: single fault condition.

2) MTBF as per Telcordia SR-332.

For MDS-300APB18, MTBF as per Telcordia SR-332 (I/P: 115Vac, O/P: 100% load for Convection, Ta: 35°C).

19V, 24V Output

MDS



HIGHLIGHTS & FEATURES

- Over-Voltage/Load/Temperature & Short Circuit Protections
- Low touch current (< 0.1mA Normal & < 0.3mA Single Fault)
- Up to 300W with convection cooling, 400W with forced air
- Compliant with IEC 60601-1-2 4th Ed. Requirements
- Safety approvals for medical and IT applications
- High MTBF
- 2 × MOPP isolation
- Remote sense

GENERAL SPECIFICATIONS

OUTPUT	MDS-400AUS19	MDS-400AUS24
Output Voltage	19V	24V
Output Current (Max)	15.8A (Convection) 21.1A (with 200LFM Forced Air)	12.5A (Convection) 16.67A (with 200LFM Forced Air)
Output Power	300W (Convection) 40W (with 200LFM Forced Air)	300W (Convection) 400W (with 200LFM Forced Air)
Load Regulation	± 2%	
Ripple & Noise	100.8 mV pk-pk @ Full load	123.2mV pk-pk @ Full load
INPUT		
Input Voltage Range	90-264Vac	
Input Frequency	47-63Hz	
Efficiency	91.38% typ.	91.94% typ.
Touch Current ¹⁾ (264Vac)	< 0.1mA @ NC, < 0.3mA @ SFC	
MECHANICAL		
Dimensions (L × W × H)	198 × 97 × 41.5 mm (7.80" × 3.82" × 1.63")	198 × 97 × 41.5 mm (7.80" × 3.82" × 1.63")
Unit Weight	0.91 kg (2.01 lb)	0.91 kg (2.01 lb)
MTBF ²⁾	2,000,000 hrs	2,000,000 hrs
EMC & Emissions	EN 55011/EN 55032, FCC Title 47: Class B	
ENVIRONMENT		
Operating Temperature	-10°C to +70°C	
Storage Temperature	-40°C to +85°C	
Operating Humidity	10 to 95% RH (Non-Condensing)	
Operating Altitude	0 to 3,000 m (0 to 9,840 ft)	
MEDICAL RATING		
Float Rating	B	
MOPP	2 × MOPP	

Dimensions Reference

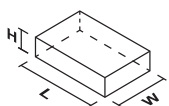

Notes

- 1) NC: normal condition, SFC: single fault condition.
- 2) MTBF as per Telcordia SR-332.

MDS Open Frame Power Supply

24V Output

MDS

HIGHLIGHTS & FEATURES

- Universal AC input voltage
- Safety approvals for medical and IT applications
- Over-Voltage/Load/Temperature & Short Circuit Protections
- Low touch current (< 0.1mA Normal & < 0.3mA Single Fault)
- Compliant with IEC 60601-1-2 4th Ed. Requirements
- 2 × MOPP isolation
- High MTBF

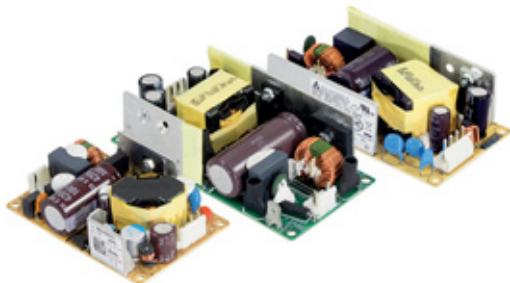

GENERAL SPECIFICATIONS

OUTPUT	MDS-040APS24	MDS-065APS24	MDS-100APS24S	MDS-100BPS24S
Output Voltage	24V	24V	24V	24V
Output Current (Max)	1.67A	2.71A	4.17A	3.3A (Convection) 4.2A (with 10CFM Forced Air)
Output Power	40W	65W	100W	80W (Convection) 100W (with 10CFM Forced Air)
Load Regulation	± 1%			
Ripple & Noise	34mV pk-pk @ Full load	32.8mV pk-pk @ Full load	55.2 mV pk-pk @ Full load	58.4mV pk-pk @ Full load
INPUT				
Input Voltage Range	90-264Vac			
Input Frequency	47-63Hz			
Efficiency	86.3% typ.	88.4% typ.	91.08% typ.	89.3% typ.
Touch Current ¹⁾ (264Vac)	< 0.1mA @ NC, < 0.3mA @ SFC			
Leakage Current ¹⁾ (264Vac)	-		< 0.15mA @ NC, < 0.3mA @ SFC	
MECHANICAL				
Dimensions (L × W × H)	76.2 × 50.8 × 23 mm (3.00" × 2.00" × 0.91")	101.6 × 50.8 × 30 mm (4.00" × 2.00" × 1.18")	127 × 76.2 × 31 mm (5.00" × 3.00" × 1.22")	101.6 × 50.8 × 31.8 mm (4.00" × 2.00" × 1.25")
Unit Weight	0.08 kg (0.18 lb)	0.13 kg (0.29 lb)	0.21 kg (0.46 lb)	0.15 kg (0.33 lb)
MTBF ²⁾	3,000,000 hrs	2,500,000 hrs	3,000,000 hrs	1,000,000 hrs
EMC & Emissions	EN 55011/EN 55032, FCC Title 47: Class B			
ENVIRONMENT				
Operating Temperature	-10°C to +70°C			
Storage Temperature	-40°C to +85°C			
Operating Humidity	10 to 95% RH (Non-Condensing)			
Operating Altitude	0 to 3,000 m (0 to 9,840 ft)			0 to 5,000 m (0 to 16,400 ft)
MEDICAL RATING				
Float Rating	BF			
MOPP	2 × MOPP			

Dimensions Reference

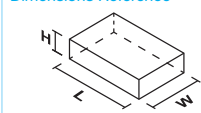

Notes

- 1) NC: normal condition, SFC: single fault condition.
- 2) MTBF as per Telcordia SR-332.

24V, 48V Output

MDS

HIGHLIGHTS & FEATURES

- Universal AC input voltage range
- Safety approvals for medical and IT applications
- Compliant with IEC 60601-1-2 4th Ed. Requirements
- Enclosed cover design option available
- Suitable for type BF medical product
- 2 × MOPP isolation
- Power Good signal

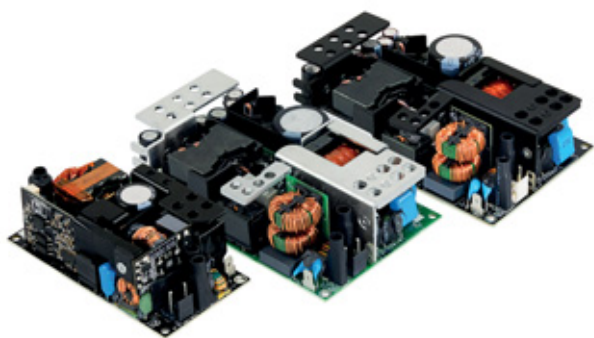

GENERAL SPECIFICATIONS

OUTPUT	MDS-200APB24	MDS-250APB24	MDS-300APB24	MDS-400APB24	MDS-300APB48
Output Voltage	24V	24V	24V	24V	48V
Output Current (Max)	5.83A (Convection) 8.33A (with 5.5CFM Forced Air)	6.25A (Convection) 10.41A (with 10CFM Forced Air)	10.0A (Convection) 12.5A (with 10CFM Forced Air)	16.66A (with 10CFM Forced Air)	5.0A (Convection) 6.25A (with 10CFM Forced Air)
Output Power	140W (Convection) 200W (with 5.5CFM Forced Air)	150W (Convection) 250W (with 10CFM Forced Air)	240W (Convection) 300W (with 10CFM Forced Air)	400W (with 10CFM Forced Air)	240W (Convection) 300W (with 10CFM Forced Air)
Load Regulation	± 2.5%				
Ripple & Noise	1% typ. pk-pk Vrated @ Full load				
INPUT					
Input Voltage Range	90-264Vac				
Input Frequency	47-63Hz				
Efficiency	92.0% typ. @ 115Vac/60Hz 93.0% typ. @ 230vac/50Hz	91.85% typ. @ 15Vac/60Hz 92.98% typ. @ 230vac/50Hz	93.0% typ. @ 115Vac/60Hz 94.0% typ. @ 230vac/50Hz	92.0% typ. @ 115Vac/60Hz 93.0% typ. @ 230vac/50Hz	92.5% typ. @ 115Vac/60Hz 93.5% typ. @ 230Vac/50Hz
Leakage Current ¹⁾ (264Vac)	Input-PE: < 0.1mA @ NC, < 0.3mA @ SFC Output-PE: < 0.1mA @ NC, < 0.5mA @ SFC				
MECHANICAL					
Dimensions (L x W x H)	101.9 x 51.1 x 36.1 mm (4.01" x 2.01" x 1.42")	127.3 x 76.5 x 36.1 mm (5.01" x 3.01" x 1.42")	127.3 x 76.5 x 36.1 mm (5.01" x 3.01" x 1.42")	127.3 x 76.5 x 36.1 mm (5.01" x 3.01" x 1.42")	127.3 x 76.5 x 36.1 mm (5.01" x 3.01" x 1.42")
Unit Weight	0.20 kg (0.44 lb)	0.41 kg (0.90 lb)	0.41 kg (0.90 lb)	0.41 kg (0.90 lb)	0.41 kg (0.90 lb)
MTBF ²⁾	800,000 hrs	500,000 hrs	800,000 hrs	500,000 hrs	800,000 hrs
EMC & Emissions	EN 55011/EN 55032, FCC Title 47: Class B				
ENVIRONMENT					
Operating Temperature	-10°C to +70°C				
Storage Temperature	-40°C to +85°C				
Operating Humidity	5 to 95% RH (Non-Condensing)				
Operating Altitude	0 to 5,000 m (0 to 16,400 ft)				
MEDICAL RATING					
Float Rating	BF				
MOPP	2 × MOPP				

Dimensions Reference

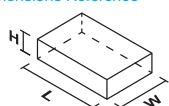

Notes

- 1) NC: normal condition, SFC: single fault condition.
- 2) MTBF as per Telcordia SR-332 (I/P: 115Vac, O/P: 100% load for Convection, Ta: 35°C).
For MDS-400APB24, MTBF as per Telcordia SR-332 (Confidence level: 90%, I/P: 115Vac, O/P: 100% load with 10CFM Forced Air, Ta: 35°C).

MDS Open Frame Power Supply

5.1V/12V/-15V/15V Output

MDS



HIGHLIGHTS & FEATURES

- Safety approvals for medical and IT applications
- Over-Voltage/Load/Temperature & Short Circuit Protections
- Low leakage current (< 0.1mA Normal & < 0.3mA Single Fault)
- Compliant with IEC 60601-1-2 4th Ed. Requirements
- 1.4 million hours MTBF
- 2 × MOPP isolation

GENERAL SPECIFICATIONS

OUTPUT	MDS-100AP401			
Output Voltage	5.1V	12V	-15V	15V
Output Current (Max)	4.0A (Convection) 8.0A (with 5CFM Forced Air)	2.0A (Convection) 3.0A (with 5CFM Forced Air)	0.6A (Convection) 0.8A (with 5CFM Forced Air)	0.8A (Convection) 0.8A (with 5CFM Forced Air)
Output Power	65W (Convection) 100W (with 5CFM Forced Air)			
Load Regulation	± 2%	± 1%	± 3%	
Ripple & Noise	36.8 mV pk-pk @ Full load	76.8 mV pk-pk @ Full load	12.8 mV pk-pk @ Full load	20.8 mV pk-pk @ Full load
INPUT				
Input Voltage Range	90-264Vac			
Input Frequency	47-63Hz			
Efficiency	79.34% typ.			
Leakage Current ¹⁾ (264Vac)	< 0.1mA @ NC, < 0.3mA @ SFC			
MECHANICAL				
Dimensions (L × W × H)	127 × 76.2 × 30.5 mm (5.00" × 3.00" × 1.20")			
Unit Weight	0.25 kg (0.55 lb)			
MTBF ²⁾	1,400,000 hrs			
EMC & Emissions	EN 55011/EN 55032, FCC Title 47: Class B			
ENVIRONMENT				
Operating Temperature	-10°C to +70°C			
Storage Temperature	-40°C to +85°C			
Operating Humidity	5 to 95% RH (Non-Condensing)			
Operating Altitude	0 to 5,000 m (0 to 16,400 ft)			
MEDICAL RATING				
Float Rating	B			
MOPP	2 × MOPP			

Dimensions Reference

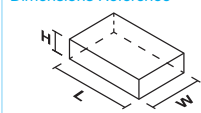

Notes

- 1) NC: normal condition, SFC: single fault condition.
- 2) MTBF as per Telcordia SR-332.

MEP Open Frame Power Supply

15V Output

MEP

HIGHLIGHTS & FEATURES

- Safety approvals for medical and IT applications
- Compliant with IEC 60601-1-2 4th Ed. Requirements
- Low leakage current (< 70µA Normal & < 210µA Single Fault)
- Over-Voltage/Load/Temperature & Short Circuit protections
- 3 million hours MTBF
- 2 × MOPP isolation



GENERAL SPECIFICATIONS

NEW	
OUTPUT	MEP-25A15J
Output Voltage	15V
Output Current (Max)	1.67A
Output Power	25W
Load Regulation	± 0.5%
Ripple & Noise	120mV pk-pk
INPUT	
Input Voltage Range	90-264Vac
Input Frequency	47-63Hz
Efficiency	86.5% typ.
Leakage Current ¹⁾ (240Vac)	< 70µA @ NC, < 210µA @ SFC
MECHANICAL	
Dimensions (L × W × H)	76.2 × 50.8 × 23 mm (3.00" × 2.00" × 0.91")
Unit Weight	0.07 kg (0.15 lb)
MTBF ²⁾	3,000,000 hrs
EMC & Emissions	EN 55011/EN 55032, FCC Title 47: Class B
ENVIRONMENT	
Operating Temperature	-10°C to +70°C
Storage Temperature	-40°C to +85°C
Operating Humidity	10 to 95% RH (Non-Condensing)
Operating Altitude	0 to 5,000 m (0 to 16,400 ft)
MEDICAL RATING	
Float Rating	BF
MOPP	2 × MOPP

Dimensions Reference

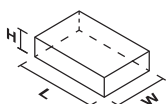

Notes

- 1) NC: normal condition, SFC: single fault condition.
- 2) MTBF as per Telcordia SR-332.

Enclosed Power Supply

Open Frame Power Supply

ATX Power Supply

Configurable Power Supply

Adapter

MEU Open Frame Power Supply

24V, 48V Output

MEU



HIGHLIGHTS & FEATURES

- Up to 600W convection cooled
- Full power from 90Vac to 264Vac, up to 50°C ambient
- Up to 500K hours MTBF
- 2 × MOPP isolation, Suitable for type BF medical products
- 5V/1A standby output and 12V/0.6A fan output for system
- Compliant with IEC 60601-1-2 4th Ed. Requirements
- PMBus Ver 1.3 supported

GENERAL SPECIFICATIONS

	NEW	
OUTPUT	MEU-600C24T	MEU-600C48T
Output Voltage	24V	48V
Output Current (Max)	25.0A	12.5A
Output Power	600W	600W
Load Regulation	2%	
Ripple & Noise	1% typ. pk-pk Vrated @ Rated load	1% typ. pk-pk Vrated @ Rated load
INPUT		
Input Voltage Range	85-264Vac	85-264Vac
Input Frequency	47-63Hz	
Efficiency	92.5% typ. @ 115Vac/60Hz 94.0% typ. @ 230Vac/50Hz	94.0% typ. @ 115Vac/60Hz 95.0% typ. @ 230Vac/50Hz
Touch Current ¹⁾	-	
Leakage Current ¹⁾	Input-PE: < 0.3mA @ NC, < 1mA @ SFC Output-PE: < 0.1mA @ NC, < 0.5mA @ SFC	
MECHANICAL		
Dimensions (L × W × H)	203.2 × 127 × 40 mm (8.00" × 5.00" × 1.57")	203.2 × 127 × 40 mm (8.00" × 5.00" × 1.57")
Unit Weight	1.30 kg (2.87 lb)	1.30 kg (2.87 lb)
MTBF ²⁾	500,000 hrs	500,000 hrs
EMC & Emissions	EN 55011/EN 55032, FCC Title 47: Class B	
ENVIRONMENT		
Operating Temperature	-20°C to +70°C	
Storage Temperature	-40°C to +85°C	
Operating Humidity	5 to 95% RH (Non-Condensing)	
Operating Altitude	0 to 5,000 m (0 to 16,400 ft)	
MEDICAL RATING		
Float Rating	BF	
MOPP	2 × MOPP	

Dimensions Reference

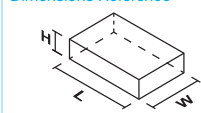

Notes

- 1) NC: normal condition, SFC: single fault condition.
- 2) MTBF as per Telcordia SR-332.



Enclosed Power Supply

Open Frame Power Supply

ATX Power Supply

Configurable Power Supply

Adapter

Delta Medical Power Supplies

ATX Power Supply



AR

MDS



- Universal AC input voltage range
- Safety approvals to medical and IT applications
- Compliant with IEC 60601-1-2 4th Ed. Requirements
- Suitable for type BF patient access applications
- ATX 12V standard function & form factor
- Maximum output power of 350 watts
- Built-in active PFC

MDS ATX Power Supply

ATX Multiple Output

MDS



HIGHLIGHTS & FEATURES

- Universal AC input voltage range
- IEC 60601-1 3.1 Ed. (Medical) & IEC 60950-1 (ITE) approvals
- Compliant with IEC 60601-1-2 4th Ed. Requirements
- Suitable for type BF patient access applications
- ATX 12V standard function & form factor
- Maximum output power of 350 watts
- Built-in active PFC

GENERAL SPECIFICATIONS

OUTPUT	MDS-350AD701						
Output Voltage	+3.3V	+5V	+5V _{SB}	+12V ₁	+12V ₂	-12V	-5V
Output Current (Nom)	8.0A	9.0A	1.25A	8.0A	8.0A	0.25A	0.1A
Output Power	350W						
Load Regulation	± 5%					± 10%	
Ripple & Noise	< 50mVpp		< 150mVpp		< 120mVpp		< 50mVpp
INPUT							
Input Voltage Range	90-264Vac						
Input Frequency	47-63Hz						
Efficiency	82% @ 115Vac/60Hz, 85% @ 230Vac/50Hz						
Leakage Current ¹⁾	< 0.1mA @ NC, < 0.3mA @ SFC						
MECHANICAL							
Dimensions (L x W x H)	100 x 194 x 40.5 mm (3.94" x 7.64" x 1.59")						
Unit Weight	1.20 kg (2.65 lb)						
MTBF ²⁾	500,000 hrs						
EMC & Emissions	EN 55011/EN 55032, FCC Title 47: Class B						
ENVIRONMENT							
Operating Temperature	0°C to +50°C						
Storage Temperature	-40°C to +85°C						
Operating Humidity	5 to 95% RH (Non-Condensing)						
Operating Altitude	0 to 5,000 m (0 to 16,400 ft)						
MEDICAL RATING							
Float Rating	BF						
MOPP	2 x MOPP						

Dimensions Reference

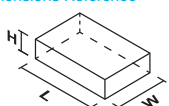

Notes

- 1) NC: normal condition, SFC: single fault condition.
- 2) MTBF as per Telcordia SR-332 (I/P: 115Vac, O/P: 100% load, Ta: 35°C).

Delta Medical Power Supplies

Configurable Power Supply



AR

MEG



- Compact size and High Power Density
- 2 × MOPP isolation
- Output selectable from 2Vdc to 60Vdc
- Optional CV/CC Version on demand
- Normal and Reversed Option for Global Remote On/Off
- Analog and Digital Voltage Trimming
- PMBus Ver 1.3 Supported

MEG Configurable Power Supply

MEG



HIGHLIGHTS & FEATURES

- Compact size and High Power Density
- 2 × MOPP isolation
- Output selectable from 2Vdc to 60Vdc
- Optional CV/CC Version on demand
- Normal and Reversed Option for Global Remote On/Off
- Analog and Digital Voltage Trimming
- PMBus Ver 1.3 Supported
- Optional RS485/RS232/USB Communication Adapters

GENERAL SPECIFICATIONS

	COMING SOON	NEW
OUTPUT	MEG-1K2A4	MEG-2K1A6
Output Slots	4 Slots	6 Slots
Output Module	Single Slot / Triple Slot	Single Slot / Triple Slot
Output Numbers	Single Output / Dual Output	Single Output / Dual Output
Output Voltage	2V-60V	2V-60V
Output Power (Max)	1,200W	2,100W
Line Regulation	± 0.5%	
Load Regulation	± 1%	
Ripple & Noise	< 1% Vrated pk-pk or 100mV, which is larger	
Hold-up Time	12ms @ 115Vac	
Dynamic Response	± 5% @ with 50-100% load change	
Remote Sense	Up to 500mV compensation for voltage drop across	
INPUT		
Input Voltage Range	90-264Vac	
Input Frequency	47-63Hz	
Input Current	< 8.5A	< 15A
Input Surge Voltage (Max)	300Vac for 100ms	
Efficiency	92% @ 115Vac, 93% @ 230Vac	
Inrush Current	40A @ 230Vac, Cold Start	
Power Factor	> 0.95 @ 115V/50Hz & 230V/50Hz, Full load	
Patient Leakage Current ¹⁾	< 0.1mA @ NC, < 0.5mA @ SFC	
Earth Leakage Current ¹⁾	< 0.3mA @ NC, < 1mA @ SFC	
MECHANICAL		
Dimensions (L × W × H)	254 × 88.9 × 40.5 mm (10.00" × 3.50" × 1.59")	254 × 127 × 40.5 mm (10.00" × 5.00" × 1.59")
Unit Weight	1.30 kg (2.87 lb)	2.00 kg (4.41 lb)
MTBF ²⁾	500,000 hrs	500,000 hrs
EMC & Emissions	EN 55011/EN 55032, FCC Title 47: Class B	
ENVIRONMENT		
Operating Temperature	-20°C to +70°C	
Storage Temperature	-40°C to +85°C	
Operating Humidity	5 to 95% RH (Non-Condensing)	
Operating Altitude	0 to 5,000 m (0 to 16,400 ft)	
MEDICAL RATING		
Float Rating	B	
MOPP	2 × MOPP	

Dimensions Reference

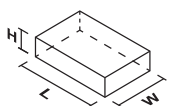

Notes

- 1) NC: normal condition, SFC: single fault condition.
- 2) MTBF as per Telcordia SR-332 (I/P: 150Vac, O/P: 1,200W for MEG-1K2A4 / 1,800W for MEG-2K1A6, Ta: 35°C).

Delta Medical Power Supplies

Adapter

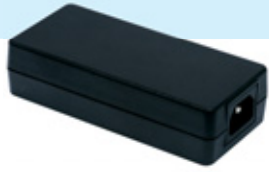

MDS



- Safety approvals for medical and IT applications
- Over-Voltage/Load/Temperature & Short Circuit Protections
- Low touch current (< 0.1mA Normal & < 0.3mA Single Fault)
- Compliant with IEC 60601-1-2 4th Ed. Requirements
- 2 × MOPP isolation

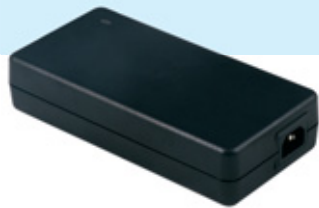

MEA



- Universal AC input voltage range
- High Efficiency meet DoE VI
- 2 × MOPP isolation
- High MTBF
- Safety approvals for medical and IT applications



MEF



- Safety approvals for medical and IT applications
- Compliant with IEC 60601-1-2 4th Ed. Requirements
- Meets Limited Power Source (LPS) requirements
- IP22 ingress protection rating
- 500K hours MTBF
- 2 × MOPP isolation

MDS Adapter

5V, 6V, 7V Output

MDS

HIGHLIGHTS & FEATURES

- Universal AC input voltage range
- Over-Voltage/Load/Temperature & Short Circuit Protections
- Compliant with IEC 60601-1-2 4th Ed. Requirements
- Safety approvals for medical and IT applications
- Low touch current (< 0.1mA Normal & < 0.3mA Single Fault)
- IP22 Ingress Protection Rating
- 2 × MOPP isolation



GENERAL SPECIFICATIONS

OUTPUT	MDS-005AAS05	MDS-030AAC05	MDS-005AAS06	MDS-030AAC07
Output Voltage	5V	5V	6V	7V
Output Current (Max)	1.0A	3.0A	0.83A	3.0A
Output Power	5W	15W	5W	21W
Load Regulation	± 8%	± 5%	± 8%	± 5%
Ripple & Noise	88mV pk-pk @ Full load	< 100mV pk-pk @ Rated load	111.2mV pk-pk @ Full load	< 100mV pk-pk @ Rated load
INPUT				
Input Voltage Range	90-264Vac	85-264Vac	90-264Vac	85-264Vac
Input Frequency	47-63Hz			
Average Efficiency	73.63% @ 115Vac & 230Vac	81.4% @ 115Vac & 230Vac	72.4% @ 115Vac & 230Vac	81.4% @ 115Vac & 230Vac
Touch Current ¹⁾ (264Vac)	< 0.1mA @ NC, < 0.3mA @ SFC			
Leakage Current ¹⁾ (264Vac)	-	< 0.1mA @ NC, < 0.5mA @ SFC	-	< 0.1mA @ NC, < 0.5mA @ SFC
MECHANICAL				
Dimensions (L × W × H)	56.5 × 39.5 × 28 mm (2.22" × 1.56" × 1.10")	88 × 53.5 × 27.5 mm (3.46" × 2.11" × 1.08")	56.5 × 39.5 × 28 mm (2.22" × 1.56" × 1.10")	88 × 53.5 × 27.5 mm (3.46" × 2.11" × 1.08")
Unit Weight	0.10 kg (0.22 lb)	0.15 kg (0.33 lb)	0.10 kg (0.22 lb)	0.15 kg (0.33 lb)
Connector Type	MDS-005AAS□: Input: Wall mount – US & EU & CN type; Output: O type/Barrel type/Tuning fork type/Micro USB-B type MDS-030AAC□: Input: Wall mount-CN/US/EU/UK/AU/KR/IN/AR/BZ/SA; Output: Barrel type/Tuning fork type			
MTBF ²⁾	1,000,000 hrs	500,000 hrs	1,000,000 hrs	500,000 hrs
EMC & Emissions	EN 55011/EN 55032, FCC Title 47: Class B			
ENVIRONMENT				
Operating Temperature	0°C to +40°C			
Storage Temperature	-40°C to +85°C			
Operating Humidity	5 to 95% RH (Non-Condensing)			
Operating Altitude	0 to 3,000 m (0 to 9,840 ft)	0 to 5,000 m (0 to 16,400 ft)	0 to 3,000 m (0 to 9,840 ft)	0 to 5,000 m (0 to 16,400 ft)
Degree of Protection	IP22			
Protection Against Shock	Class II			
MEDICAL RATING				
Float Rating	BF			
MOPP	2 × MOPP			

Dimensions Reference

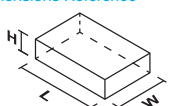

Notes

- 1) NC: normal condition, SFC: single fault condition.
- 2) MTBF as per Telcordia SR-332 (I/P: 100Vac, O/P: 100% load, Ta: 25°C).

MDS Adapter

12V Output

MDS

HIGHLIGHTS & FEATURES

- Universal AC input voltage range
- Over-Voltage/Load/Temperature & Short Circuit Protections
- Low touch current (< 0.1mA Normal & < 0.3mA Single Fault)
- Compliant with IEC 60601-1-2 4th Ed. Requirements
- Safety approvals for medical and IT applications
- 2 × MOPP isolation



GENERAL SPECIFICATIONS

OUTPUT	MDS-030AAC12	MDS-060AAS12	MDS-060BAS12	MDS-080AAS12	MDS-150AAS12
Output Voltage	12V	12V	12V	12V	12V
Output Current (Max)	2.0A	5.0A	5.0A	6.67A	10.0A
Output Power	24W	60W	60W	80W	120W
Load Regulation	± 5%	± 4.5%	± 5%	± 4.5%	
Ripple & Noise	< 150mV pk-pk @ Rated load	67mV pk-pk @ Full load	1% typ. pk-pk @ Full load	118.4mV pk-pk @ Full load	104mV pk-pk @ Full load
INPUT					
Input Voltage Range	85-264Vac	90-275Vac	90-264Vac		
Input Frequency	47-63Hz				
Average Efficiency	86.21% @ 115Vac & 230Vac	87.0% @ 115Vac	88.0% @ 115Vac & 230Vac	83% typ.	88.0% @ 115Vac, 87.0% @ 230Vac
Touch Current ¹⁾	< 0.1mA @ 264Vac NC, < 0.3mA @ 264Vac SFC	< 0.1mA @ 275Vac NC, < 0.3mA @ 275Vac SFC	< 0.1mA @ 264Vac NC, < 0.3mA @ 264Vac SFC		
Leakage Current ¹⁾	< 0.1mA @ 264Vac NC, < 0.5mA @ 264Vac SFC	< 0.1mA @ 275Vac NC, < 0.3mA @ 275Vac SFC	-		
MECHANICAL					
Dimensions (L × W × H)	88 × 53.5 × 27.5 mm (3.46" × 2.11" × 1.08")	135 × 62 × 34.1 mm (5.31" × 2.44" × 1.34")	135 × 62 × 34.1 mm (5.31" × 2.44" × 1.34")	150 × 75 × 40 mm (5.91" × 2.95" × 1.57")	170 × 85 × 40 mm (6.69" × 3.35" × 1.57")
Unit Weight	0.15 kg (0.33 lb)	0.36 kg (0.79 lb)	0.34 kg (0.75 lb)	0.50 kg (1.10 lb)	1.10 kg (2.43 lb)
Connector Type	MDS-030AAC12: Input: Wall mount-CN/US/EU/UK/AU/KR/IN/AR/BZ/SA; Output: Barrel type/Tuning fork type MDS-060AAS12: Input: C14 socket; Output: 4-pin DIN/Barrel type/Tuning fork type MDS-060BAS12, MDS-080AAS12: Input: C8 socket; Output: 4-pin DIN/Barrel type/Tuning fork type MDS-150AAS12: Input: C14 socket; Output: 4-pin DIN/Barrel type/Tuning fork type (Select the appropriate DC plug according to the current)				
MTBF ²⁾	500,000 hrs	1,000,000 hrs	1,000,000 hrs	1,000,000 hrs	1,000,000 hrs
EMC & Emissions	EN 55011/EN 55032, FCC Title 47: Class B				
ENVIRONMENT					
Operating Temperature	0°C to +40°C				
Storage Temperature	-40°C to +85°C				
Operating Humidity	5 to 95% RH (Non-Condensing)	10 to 95% RH (Non-Condensing)	5 to 95% RH (Non-Condensing)	10 to 95% RH (Non-Condensing)	
Operating Altitude	0 to 5,000 m (0 to 16,400 ft)	0 to 3,000 m (0 to 9,840 ft)	0 to 5,000 m (0 to 16,400 ft)		0 to 3,000 m (0 to 9,840 ft)
Degree of Protection	IP22	-	IP22		-
Protection Against Shock	Class II	Class I	Class II		Class I for F series, Class II with functional earth for B series
MEDICAL RATING					
Float Rating	BF				B
MOPP	2 × MOPP				

Dimensions Reference

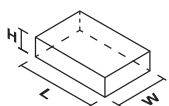

Notes

1) NC: normal condition, SFC: single fault condition.

2) MTBF as per Telcordia SR-332.

For MDS-030AAC12, MTBF as per Telcordia SR-332 (I/P: 100Vac, O/P: 100% load, Ta: 25°C).

15V Output

MDS

HIGHLIGHTS & FEATURES

- Universal AC input voltage range
- Over-Voltage/Load/Temperature & Short Circuit Protections
- Low touch current (< 0.1mA Normal & < 0.3mA Single Fault)
- Compliant with IEC 60601-1-2 4th Ed. Requirements
- Safety approvals for medical and IT applications
- 2 × MOPP isolation



GENERAL SPECIFICATIONS

OUTPUT	MDS-030AAC15	MDS-060AAS15	MDS-090AAS15
Output Voltage	15V	15V	15V
Output Current (Max)	2.0A	4.0A	6.0A
Output Power	30W	60W	90W
Load Regulation	± 5%	± 4.5%	
Ripple & Noise	< 200mV pk-pk @ Rated load	61mV pk-pk @ Full load	114mV pk-pk @ Full load
INPUT			
Input Voltage Range	85-264Vac	90-275Vac	90-264Vac
Input Frequency	47-63Hz		
Average Efficiency	87.0% @ 115Vac & 230Vac	88.0% @ 115Vac & 230Vac	88.0% @ 115Vac
Touch Current ¹⁾	< 0.1mA @ 264Vac NC, < 0.3mA @ 264Vac SFC	< 0.1mA @ 275Vac NC, < 0.3mA @ 275Vac SFC	< 0.1mA @ 264Vac NC, < 0.3mA @ 264Vac SFC
Leakage Current ¹⁾	< 0.1mA @ 264Vac NC, < 0.5mA @ 264Vac SFC	< 0.1mA @ 275Vac NC, < 0.3mA @ 275Vac SFC	< 0.1mA @ 264Vac NC, < 0.3mA @ 264Vac SFC
MECHANICAL			
Dimensions (L × W × H)	88 × 53.5 × 27.5 mm (3.46" × 2.11" × 1.08")	135 × 62 × 34.1 mm (5.31" × 2.44" × 1.34")	150 × 60 × 35 mm (5.91" × 2.36" × 1.38")
Unit Weight	0.15 kg (0.33 lb)	0.36 kg (0.79 lb)	0.45 kg (0.99 lb)
Connector Type	MDS-030AAC15: Input: Wall mount-CN/US/EU/UK/AU/KR/IN/AR/BZ/SA; Output: Barrel type/Tuning fork type MDS-060AAS15, MDS-090AAS15: Input: C14 socket; Output: 4-pin DIN/Barrel type/Tuning fork type		
MTBF ²⁾	500,000 hrs	1,000,000 hrs	1,000,000 hrs
EMC & Emissions	EN 55011/EN 55032, FCC Title 47: Class B		
ENVIRONMENT			
Operating Temperature	0°C to +40°C		
Storage Temperature	-40°C to +85°C		
Operating Humidity	5 to 95% RH (Non-Condensing)	10 to 95% RH (Non-Condensing)	
Operating Altitude	0 to 5,000 m (0 to 16,400 ft)	0 to 3,000 m (0 to 9,840 ft)	
Degree of Protection	IP22	-	
Protection Against Shock	Class II	Class I	Class I for F series Class II with functional earth for B series
MEDICAL RATING			
Float Rating	BF		B
MOPP	2 × MOPP		

Dimensions Reference

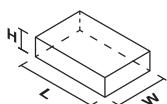

Notes

1) NC: normal condition, SFC: single fault condition.

2) MTBF as per Telcordia SR-332.

For MDS-030AAC15, MTBF as per Telcordia SR-332 (I/P: 100Vac, O/P: 100% load, Ta: 25°C).

MDS Adapter

19V Output

MDS

HIGHLIGHTS & FEATURES

- Over-Voltage/Load/Temperature & Short Circuit Protections
- Low touch current (< 0.1mA Normal & < 0.3mA Single Fault)
- Compliant with IEC 60601-1-2 4th Ed. Requirements
- Safety approvals for medical and IT applications
- 2 × MOPP isolation
- High MTBF



GENERAL SPECIFICATIONS

OUTPUT	MDS-060AAS19	MDS-060BAS19	MDS-090AAS19	MDS-150AAS19	MDS-150CAB19
Output Voltage	19V	19V	19V	19V	19V
Output Current (Max)	3.15A	3.15A	4.73A	7.89A	7.9A
Output Power	60W	60W	90W	150W	150W
Load Regulation	± 4.5%	± 5%	± 4.5%		± 5%
Ripple & Noise	61mV pk-pk @ Full load	1% typ. pk-pk @ Full load	91.2mV pk-pk @ Full load	94.4mV pk-pk @ Full load	109mV pk-pk @ Full load
INPUT					
Input Voltage Range	90-275Vac	90-264Vac	90-264Vac		
Input Frequency	47-63Hz				
Average Efficiency	88.0% @ 115Vac & 230Vac	88.0% @ 115Vac 87.0% @ 230Vac	88.0% @ 115Vac	88.0% @ 115Vac & 230Vac	92.0%
Touch Current ¹⁾	< 0.1mA @ 275Vac NC, < 0.3mA @ 275Vac SFC				
Leakage Current ¹⁾	< 0.1mA @ 275Vac NC, < 0.3mA @ 275Vac SFC	-	< 0.1mA @ 264Vac NC, < 0.3mA @ 264Vac SFC	-	-
MECHANICAL					
Dimensions (L × W × H)	135 × 62 × 34.1 mm (5.31" × 2.44" × 1.34")	135 × 62 × 34.1 mm (5.31" × 2.44" × 1.34")	150 × 60 × 35 mm (5.91" × 2.36" × 1.38")	170 × 85 × 40 mm (6.69" × 3.35" × 1.57")	150 × 65 × 32 mm (5.91" × 2.56" × 1.26")
Unit Weight	0.36 kg (0.79 lb)	0.34 kg (0.75 lb)	0.45 kg (0.99 lb)	1.10 kg (2.43 lb)	0.52 kg (1.15 lb)
Connector Type	MDS-060AAS19, MDS-090AAS19: Input: C14 socket; Output: 4-pin DIN/Barrel type/Tuning fork type MDS-060BAS19: Input: C8 socket; Output: 4-pin DIN/Barrel type/Tuning fork type MDS-150AAS19: Input: C14 socket; Output: 4-pin DIN/Barrel type/Tuning fork type (Select the appropriate DC plug according to the current) MDS-150CAB19: Input: C6 socket; Output: 4-pin DIN/Tuning fork type				
MTBF ²⁾	1,000,000 hrs	1,000,000 hrs	1,000,000 hrs	1,000,000 hrs	2,100,000 hrs
EMC & Emissions	EN 55011/EN 55032, FCC Title 47: Class B				
ENVIRONMENT					
Operating Temperature	0°C to +40°C				
Storage Temperature	-40°C to +85°C				
Operating Humidity	10 to 95% RH (Non-Condensing)	5 to 95% RH (Non-Condensing)	10 to 95% RH (Non-Condensing)		
Operating Altitude	0 to 3,000 m (0 to 9,840 ft)	0 to 5,000 m (0 to 16,400 ft)	0 to 3,000 m (0 to 9,840 ft)		0 to 5,000 m (0 to 16,400 ft)
Degree of Protection	-	IP22	-		IP22
Protection Against Shock	Class I	Class II	Class I for F series, Class II with functional earth for B series		Class I
MEDICAL RATING					
Float Rating	BF		B		
MOPP	2 × MOPP				

Dimensions Reference

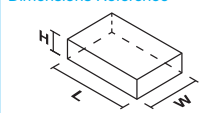

Notes

- 1) NC: normal condition, SFC: single fault condition.
- 2) MTBF as per Telcordia SR-332.

MDS

HIGHLIGHTS & FEATURES

- Universal AC input voltage range
- Over-Voltage/Load/Temperature & Short Circuit Protections
- Low touch current (< 0.1mA Normal & < 0.3mA Single Fault)
- Compliant with IEC 60601-1-2 4th Ed. Requirements
- Safety approvals for medical and IT applications
- 2 × MOPP isolation
- High MTBF



GENERAL SPECIFICATIONS

OUTPUT	MDS-030AAC24	MDS-060AAS24	MDS-060BAS24
Output Voltage	24V	24V	24V
Output Current (Max)	1.25A	2.5A	2.5A
Output Power	30W	60W	60W
Load Regulation	± 5%	± 4.5%	± 5%
Ripple & Noise	< 200mV pk-pk @ Rated load	43mV pk-pk @ Full load	1% typ. pk-pk @ Full load
INPUT			
Input Voltage Range	85-264Vac	90-275Vac	90-264Vac
Input Frequency	47-63Hz		
Average Efficiency	87.0% @ 115Vac & 230Vac	88.0% @ 115Vac 87.0% @ 230Vac	87.0% @ 115Vac & 230Vac
Touch Current ¹⁾	< 0.1mA @ 264Vac NC, < 0.3mA @ 264Vac SFC	< 0.1mA @ 275Vac NC, < 0.3mA @ 275Vac SFC	< 0.1mA @ 264Vac NC, < 0.3mA @ 264Vac SFC
Leakage Current ¹⁾	< 0.1mA @ 264Vac NC, < 0.5mA @ 264Vac SFC	< 0.1mA @ 275Vac NC, < 0.3mA @ 275Vac SFC	-
MECHANICAL			
Dimensions (L × W × H)	88 × 53.5 × 27.5 mm (3.46" × 2.11" × 1.08")	135 × 62 × 34.1 mm (5.31" × 2.44" × 1.34")	135 × 62 × 34.1 mm (5.31" × 2.44" × 1.34")
Unit Weight	0.15 kg (0.33 lb)	0.36 kg (0.79 lb)	0.34 kg (0.75 lb)
Connector Type	MDS-030AAC24: Input: Wall mount-CN/US/EU/UK/AU/KR/IN/AR/BZ/SA; Output: Barrel type/Tuning fork type MDS-060AAS24: Input: C14 socket; Output: 4-pin DIN/Barrel type/Tuning fork type MDS-060BAS24: Input: C8 socket; Output: 4-pin DIN/Barrel type/Tuning fork type		
MTBF ²⁾	500,000 hrs	1,000,000 hrs	1,000,000 hrs
EMC & Emissions	EN 55011/EN 55032, FCC Title 47: Class B		
ENVIRONMENT			
Operating Temperature	0°C to +40°C		
Storage Temperature	-40°C to +85°C		
Operating Humidity	5 to 95% RH (Non-Condensing)	10 to 95% RH (Non-Condensing)	5 to 95% RH (Non-Condensing)
Operating Altitude	0 to 5,000 m (0 to 16,400 ft)	0 to 3,000 m (0 to 9,840 ft)	0 to 5,000 m (0 to 16,400 ft)
Degree of Protection	IP22	-	IP22
Protection Against Shock	Class II	Class I	Class II
MEDICAL RATING			
Float Rating	BF		
MOPP	2 × MOPP		

Dimensions Reference

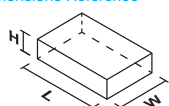

Notes

1) NC: normal condition, SFC: single fault condition.

2) MTBF as per Telcordia SR-332.

For MDS-030AAC24, MTBF as per Telcordia SR-332 (I/P: 100Vac, O/P: 100% load, Ta: 25°C).

MDS Adapter

24V Output

MDS

HIGHLIGHTS & FEATURES

- Universal AC input voltage range
- Over-Voltage/Load/Temperature & Short Circuit Protections
- Low touch current (< 0.1mA Normal & < 0.3mA Single Fault)
- Compliant with IEC 60601-1-2 4th Ed. Requirements
- Safety approvals for medical and IT applications
- 2 × MOPP isolation
- High MTBF



GENERAL SPECIFICATIONS

OUTPUT	MDS-090AAS24	MDS-090BAS24	MDS-150AAS24
Output Voltage	24V	24V	24V
Output Current (Max)	3.75A	3.75A	6.25A
Output Power	90W	90W	150W
Load Regulation	± 4.5%		
Ripple & Noise	94.4mV pk-pk @ Full load	107.2mV pk-pk @ Full load	83.2mV pk-pk @ Full load
INPUT			
Input Voltage Range	90-264Vac		
Input Frequency	47-63Hz		
Average Efficiency	88.0%		88.0% @ 115Vac, 87.0% @ 230Vac
Touch Current ¹⁾ (264Vac)	< 0.1mA @ NC, < 0.3mA @ SFC		
Leakage Current ¹⁾ (264Vac)	< 0.1mA @ NC, < 0.3mA @ SFC	-	-
MECHANICAL			
Dimensions (L × W × H)	150 × 60 × 35 mm (5.91" × 2.36" × 1.38")	150 × 75 × 40 mm (5.91" × 2.95" × 1.57")	170 × 85 × 40 mm (6.69" × 3.35" × 1.57")
Unit Weight	0.45 kg (0.99 lb)	0.50 kg (1.10 lb)	1.10 kg (2.43 lb)
Connector Type	MDS-090AAS24: Input: C14 socket; Output: 4-pin DIN/Barrel type/Tuning fork type MDS-090BAS24: Input: C8 socket; Output: 4-pin DIN/Barrel type/Tuning fork type MDS-150AAS24: Input: C14 socket; Output: 4-pin DIN/Barrel type/Tuning fork type (Select the appropriate DC plug according to the current)		
MTBF ²⁾	1,000,000 hrs	1,000,000 hrs	1,000,000 hrs
EMC & Emissions	EN 55011/EN 55032, FCC Title 47: Class B		
ENVIRONMENT			
Operating Temperature	0°C to +40°C		
Storage Temperature	-40°C to +85°C		
Operating Humidity	10 to 95% RH (Non-Condensing)		
Operating Altitude	0 to 3,000 m (0 to 9,840 ft)	0 to 5,000 m (0 to 16,400 ft)	0 to 3,000 m (0 to 9,840 ft)
Degree of Protection	-	IP22	-
Protection Against Shock	Class I for F series, Class II with functional earth for B series	Class II	Class I for F series, Class II with functional earth for B series
MEDICAL RATING			
Float Rating	B	BF	B
MOPP	2 × MOPP		

Dimensions Reference

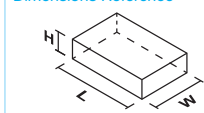

Notes

- 1) NC: normal condition, SFC: single fault condition.
- 2) MTBF as per Telcordia SR-332.

MEA Adapter

15V, 24V Output

MEA

HIGHLIGHTS & FEATURES

- Universal AC input voltage range
- High Efficiency meet DoE VI
- 2 × MOPP isolation
- High MTBF
- Safety approvals for medical and IT applications



GENERAL SPECIFICATIONS

	NEW	NEW
OUTPUT	MEA-120A15B	MEA-250A24C
Output Voltage	15V	24V
Output Current (Max)	8.0A	10.42A
Output Power	120W	250W
Load Regulation	± 5%	± 4.5%
Ripple & Noise	< 250mV pk-pk	< 240mVpk-pk
INPUT		
Input Voltage Range	90-264Vac	
Input Frequency	47-63Hz	
Average Efficiency	88.0% typ.	90.0% typ.
Touch Current ¹⁾	-	< 0.1mA @ 264Vac NC, < 0.3mA @ 264Vac SFC
Leakage Current ¹⁾	< 0.1mA at 264Vac/50Hz	< 0.2mA @ 264Vac NC, < 0.5mA @ 264Vac SFC
MECHANICAL		
Dimensions (L × W × H)	170 × 85 × 40 mm (6.69" × 3.35" × 1.57")	200 × 100 × 43 mm (7.87" × 3.94" × 1.69")
Unit Weight	0.74 kg (1.63 lb)	1.05 kg (2.31 lb)
Connector Type	MEA-120A15B: Input: C8 socket; Output: 4-pin DIN MEA-250A24C: Input: C14 socket; Output: 6-pin mini-fit	
MTBF ²⁾	1,000,000 hrs	500,000 hrs
EMC & Emissions	EN 55011/EN 55032	EN 55011/EN 55032, FCC Title 47: Class B
ENVIRONMENT		
Operating Temperature	0°C to +40°C	5°C to +60°C
Storage Temperature	-40°C to +85°C	-40°C to +70°C
Operating Humidity	5 to 95% RH (Non-Condensing)	
Operating Altitude	0 to 5,000 m (0 to 16,400 ft)	
Degree of Protection	IP20	IP22
Protection Against Shock	Class II	Class I
MEDICAL RATING		
Float Rating	B	BF
MOPP	2 × MOPP	

Dimensions Reference

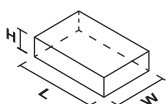

Notes

- 1) NC: normal condition, SFC: single fault condition.
- 2) MTBF as per Telcordia SR-332.
For MEA-250A24C, MTBF as per Telcordia SR-332 (I/P: 115Vac, O/P: 100% load, Ta: 25°C).

MEF Adapter

5V Output

MEF

HIGHLIGHTS & FEATURES

- Safety approvals for medical and IT applications
- Compliant with IEC 60601-1-2 4th Ed. Requirements
- Meets Limited Power Source (LPS) requirements
- IP22 ingress protection rating
- 500K hours MTBF
- 2 × MOPP isolation



GENERAL SPECIFICATIONS

NEW	
OUTPUT	MEF-010A05B
Output Voltage	5V
Output Current (Max)	2.0A
Output Power	10W
Load Regulation	± 8%
Ripple & Noise	100mV pk-pk
INPUT	
Input Voltage Range	85-264Vac
Input Frequency	47-63Hz
Efficiency	73.4% typ.
Touch Current	-
Leakage Current	< 0.1mA
MECHANICAL	
Dimensions (L × W × H)	70 × 43 × 27.5 mm (2.76" × 1.69" × 1.08")
Unit Weight	0.95 kg (2.09 lb)
Connector Type	Input: Wall mount - US Type; Output: Barrel type
MTBF ¹⁾	500,000 hrs
EMC & Emissions	EN 55011 / EN 55032, FCC Title 47: Class B
ENVIRONMENT	
Operating Temperature	0°C to +40°C
Storage Temperature	-40°C to +85°C
Operating Humidity	10 to 95% RH (Non-Condensing)
Operating Altitude	0 to 5,000 m (0 to 16,400 ft)
Degree of Protection	IP22
Protection Against Shock	Class II
MEDICAL RATING	
Float Rating	B
MOPP	2 × MOPP

Dimensions Reference

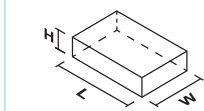

Notes

1) MTBF as per Telcordia SR-332.

Standard Products

Delta LED Power Supplies



Product Types

1 LED Driver

Delta LED drivers are designed according to major international safety standards for various indoor and outdoor lighting applications. Every piece is rigorously tested for the highest quality and reliability.



- IP65 Protection

LNE-□V□W□□□, LNV-□V□W□□□

With potentiometers to adjust output voltage and constant current level



100-185W



320W

- IP67 Protection

LNE-□V□W□□□, LNV-□V□W□□□

Without dimming cable and potentiometers



320W

LNE-□V□W□□□, LNV-□V□W□□□

With dimming cable to adjust constant current level



100-185W



320W

2 Open Frame

The open frame power supply is designed in standard industrial 3" x 5" footprint for lighting applications. The highly efficient fan or convection cooled design with optimum thermal management for high power needs.



Selection Guide

Delta LED Power Supplies

New products are frequently introduced. Please visit www.DeltaPSU.com for latest product updates.

Product Type	Series	Model Name	Phase	PFC	Output Voltage	Output Current	Output Power	Input Voltage Range	Page
			1						
LED Driver	LNE • High surge immunity • IP65/IP67 Compliant • LED lighting power solution	LNE-12V100W□AA	●	●	12V	8.0A	96W	90-305Vac	109
		LNE-12V120W□AA	●	●		10.0A	120W		
		LNE-12V150W□AA	●	●		12.5A	150W		
		LNE-12V185W□AA	●	●		13.0A	156W		
		LNE-12V320W□AA	●	●		22.5A	270W		
		LNE-12V100W□CA	●	●	12V	8.0A	96W	90-264Vac	110
		LNE-12V120W□CA	●	●		10.0A	120W		
		LNE-12V150W□CA	●	●		12.5A	150W		
		LNE-12V185W□AA	●	●		13.0A	156W		
		LNE-12V320W□AA	●	●		22.5A	270W		
		LNE-24V100W□AA	●	●	24V	4.0A	96W	90-305Vac	111
		LNE-24V120W□AA	●	●		5.0A	120W		
		LNE-24V150W□AA	●	●		6.3A	151.2W		
		LNE-24V185W□AA	●	●		7.8A	187.2W		
		LNE-24V320W□AA	●	●		13.4A	320W		
		LNE-24V100W□CA	●	●	24V	4.0A	96W	90-264Vac	112
		LNE-24V120W□CA	●	●		5.0A	120W		
		LNE-24V150W□CA	●	●		6.3A	151.2W		
		LNE-24V185W□CA	●	●		7.8A	187.2W		
		LNE-24V320W□CA	●	●		13.4A	320W		
		LNE-36V100W□AA	●	●	36V	2.65A	95.4W	90-305Vac	113
		LNE-36V120W□AA	●	●		3.4A	122.4W		
		LNE-36V150W□AA	●	●		4.2A	151.2W		
		LNE-36V185W□AA	●	●		5.2A	187.2W		
		LNE-36V320W□AA	●	●		8.9A	320W		
		LNE-36V100W□CA	●	●	36V	2.65A	95.4W	90-264Vac	114
		LNE-36V120W□CA	●	●		3.4A	122.4W		
		LNE-36V150W□CA	●	●		4.2A	151.2W		
		LNE-36V185W□CA	●	●		5.2A	187.2W		
		LNE-36V320W□CA	●	●		8.9A	320W		

LED Driver Model Numbering

LN	E -	XXV	XXXW	□	□	A
LED Driver	Product Series E - High efficiency and PFC	Output Voltage	Output Power	Package Type A - IP65 with potentiometers to adjust output voltage & constant current level B - IP67 without dimming cable & potentiometers ¹⁾ D - IP67 with dimming cable to adjust constant current level	Safety Approval 100-185W A - UL approval C - ENEC, CE, KC, PSE and CCC approval 320W A - UL approval C - ENEC, CE, and CCC approval	Variable A - Delta Standard

1) Options for 320W models only

Product Type	Series	Model Name	Phase		PFC	Output Voltage	Output Current	Output Power	Input Voltage Range	Page
			1	2						
LED Driver	LNE • High surge immunity • IP65/IP67 Compliant • LED lighting power solution	LNE-48V100W□AA	●		●	48V	2.0A	96W	90-305Vac	115
		LNE-48V120W□AA	●		●		2.5A	120W		
		LNE-48V150W□AA	●		●		3.2A	153.6W		
		LNE-48V185W□AA	●		●		3.9A	187.2W		
		LNE-48V320W□AA	●		●		6.7A	320W		
		LNE-48V100W□CA	●		●	2.0A	96W	90-264Vac	116	
		LNE-48V120W□CA	●		●	2.5A	120W			
		LNE-48V150W□CA	●		●	3.2A	153.6W			
		LNE-48V185W□CA	●		●	3.9A	187.2W			
		LNE-48V320W□CA	●		●	6.7A	320W			
		LNE-54V150W□AA	●		●	54V	2.8A	151.2W	90-305Vac	117
		LNE-54V185W□AA	●		●		3.45A	186.3W		
		LNE-54V150W□CA	●		●		2.8A	151.2W	90-264Vac	118
		LNE-54V185W□CA	●		●	3.45A	186.3W			

Product Type	Series	Model Name	Phase		PFC	Output Voltage	Output Current	Output Power	Input Voltage Range	Page
			1	2						
LED Driver	LNV • High input voltage • IP65/IP67 Compliant • LED lighting power solution	LNV-12V320W□AA	●	●	●	12V	22.5A	270W	180-528Vac	119
		LNV-24V320W□AA	●	●	●	24V	13.4A	320W		
		LNV-36V320W□AA	●	●	●	36V	8.9A	320W		
		LNV-48V320W□AA	●	●	●	48V	6.7A	320W		

LED Driver Model Numbering

LN	V –	XXV	XXXW	□	□	A
LED Driver	Product Series V - High input voltage	Output Voltage	Output Power	Package Type A - IP65 with potentiometers to adjust output voltage & constant current level B - IP67 without dimming cable & potentiometers D - IP67 with dimming cable to adjust constant current level	Safety Approval A - UL approval	Variable A - Delta Standard

Product Type	Series	Model Name	Phase		PFC	Output Voltage	Output Current	Output Power	Input Voltage Range	Page
			1	2						
Open Frame Power Supply	PJJ • UL 8750 and IEC/UL 60950-1 approvals • Low inrush current • LED lighting power solution	PJJ-48V200WBAA	●		●	48V	4.17A	200W	85-305Vac	121
		PJJ-48V400WBAA	●		●		8.33A	400W		

Open Frame Model Numbering

PJ	L –	XXV	XXXW	B	A	A
Open Frame	Product Type L - Lighting Application Series	Output Voltage	Output Power	Package Type B - Open Frame	Active PFC	A - TE connector

Delta LED Power Supplies

LED Driver

LNE



AR

- Constant Voltage and Constant Current Design
- North American and International AC voltage options
- 6kV common mode & 4kV differential mode surge immunity
- Adjustable voltage & current, dimming options available
- IP65 or IP67 options for indoor and outdoor applications



LED
Lighting

LNV



AR

- Constant Voltage and Constant Current Design
- Designed for single phase (for L – N) or two phase (for L – L) wide input 180-528Vac
- 6kV common mode & 4kV differential mode surge immunity
- Adjustable voltage & current, dimming options available
- IP65 or IP67 options for indoor and outdoor applications



LED
Lighting

LNE LED Driver

12V Output (North American AC Voltage)

LNE

HIGHLIGHTS & FEATURES

- Universal AC input voltage range 90-305Vac
- Up to 92.0% efficiency
- 6kV common mode & 4kV differential mode surge immunity
- Active PFC. Meets IEC/EN 61000-3-2, Class C
- Adjustable voltage & current; dimming option available
- IP65 or IP67 assembly for indoor and outdoor applications



GENERAL SPECIFICATIONS

OUTPUT	LNE-12V100W□AA	LNE-12V120W□AA	LNE-12V150W□AA	LNE-12V185W□AA	LNE-12V320W□AA
Nominal Output Voltage	12V	12V	12V	12V	12V
LED System Voltage Range in CC Mode	6-12Vdc	6-12Vdc	6-12Vdc	6-12Vdc	6-12Vdc
Output Voltage Adjustment Range ¹⁾	10.8-13.5V	10.8-13.5V	10.8-13.5V	10.8-13.5V	10.8-13.5V
Nominal Output Current	8.0A	10.0A	12.5A	13.0A	22.5A
Output Current Adjustment Range ¹⁾	4.0-8.0A	5.0-10.0A	6.25-12.5A	6.5-13.0A	11.25-22.5A
Output Power	96W	120W	150W	156W	270W
Line Regulation	± 0.5% (@ 90-305Vac)				
Load Regulation (0-95% Load)	± 2% (@ 90-305Vac)				
PARD (20MHz)	< 150mVpp				
Hold-up Time	16ms typ. @ 115Vac & 230Vac & 277Vac (100% load)				
INPUT					
Input Voltage Range	90-305Vac				
Input Frequency	47-63Hz				
Input Current	1.30A max. @ 115Vac, 0.65A max. @ 230Vac, 0.60A max. @ 277Vac	1.50A max. @ 115Vac, 0.70A max. @ 230Vac, 0.65A max. @ 277Vac	1.80A max. @ 115Vac, 0.85A max. @ 230Vac, 0.80A max. @ 277Vac	1.90A max. @ 115Vac, 0.90A max. @ 230Vac, 0.80A max. @ 277Vac	3.50A max. @ 115Vac, 1.65A max. @ 230Vac, 1.45A max. @ 277Vac
Efficiency at 100% Load	90.0% typ. @ 115Vac, 92.0% typ. @ 230Vac & 277Vac	90.0% typ. @ 115Vac, 92.0% typ. @ 230Vac & 277Vac	89.0% typ. @ 115Vac, 91.5% typ. @ 230Vac, 91.0% typ. @ 277Vac	89.0% typ. @ 115Vac, 91.5% typ. @ 230Vac & 277Vac	89.5% typ. @ 115Vac, 90.5% typ. @ 230Vac, 91.0% typ. @ 277Vac
Max Inrush Current (Cold Start)	65A typ. @ 230Vac				
Power Factor	0.98 typ. @ 115Vac, 0.95 typ. @ 230Vac, 0.93 typ. @ 277Vac		0.98 typ. @ 115Vac, 0.95 typ. @ 230Vac, 0.92 typ. @ 277Vac		
Leakage Current	< 0.75mA @ 305Vac				< 0.75mA @ 277Vac
MECHANICAL					
Case Cover / Chassis	Aluminium				
Dimensions (L x W x H)	220 x 68 x 38.8 mm (8.66" x 2.68" x 1.53")	220 x 68 x 38.8 mm (8.66" x 2.68" x 1.53")	228 x 68 x 38.8 mm (8.98" x 2.68" x 1.53")	228 x 68 x 38.8 mm (8.98" x 2.68" x 1.53")	252 x 90 x 43.8 mm (9.92" x 3.54" x 1.72")
Unit Weight	0.98 kg (2.16 lb)	0.98 kg (2.16 lb)	1.04 kg (2.29 lb)	1.04 kg (2.29 lb)	1.70 kg (3.75 lb)
Cooling System	Convection				
Input Cable	UL	SJTW 18AWGX3C (Line: Brown, Neutral: Blue, PE: Green/Yellow)			
Output Cable	UL	SJTW 14AWGX2C (Positive: Red, Negative: Black)			
Dimming Cable	UL	SJTW 18AWGX2C (Positive: White, Negative: Blue)			
MTBF ²⁾	> 700,000 hrs	> 700,000 hrs	> 700,000 hrs	> 700,000 hrs	> 700,000 hrs
ENVIRONMENT					
Operating Temperature	-40°C to +70°C				
Storage Temperature	-40°C to +85°C				
Power De-rating ³⁾	> 60°C (4% / °C)				
Operating Humidity	5 to 95% RH (Non-Condensing)				
Operating Altitude	0 to 3,000m (0 to 9,840 ft)				
Degree of Protection	IP65 (LNE-12V□WA□A); IP67 (LNE-12V320WB□A, LNE-12V□WD□A)				

Dimensions Reference

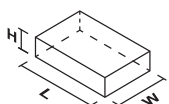

Notes

- 1) For LNE-□V□WA□A package type only.
- 2) MTBF as per Telcordia SR-332 (I/P: 115Vac, O/P: 100% load).
- 3) Please refer to the technical datasheet for information about the mounting orientations.
- 4) All parameters are specified at 25°C ambient temperature unless otherwise indicated.

LNE LED Driver

12V Output (International AC Voltage)

LNE

HIGHLIGHTS & FEATURES

- Universal AC input voltage range 90-264Vac
- Up to 92.0% efficiency
- 6kV common mode & 4kV differential mode surge immunity
- Active PFC. Meets IEC/EN 61000-3-2, Class C
- Adjustable voltage & current; dimming option available
- IP65 or IP67 assembly for indoor and outdoor applications



GENERAL SPECIFICATIONS

OUTPUT	LNE-12V100W□□A	LNE-12V120W□□A	LNE-12V150W□□A	LNE-12V185W□□A	LNE-12V320W□□A
Nominal Output Voltage	12V	12V	12V	12V	12V
LED System Voltage Range in CC Mode	6-12Vdc	6-12Vdc	6-12Vdc	6-12Vdc	6-12Vdc
Output Voltage Adjustment Range ¹⁾	10.8-13.5V	10.8-13.5V	10.8-13.5V	10.8-13.5V	10.8-13.5V
Nominal Output Current	8.0A	10.0A	12.5A	13.0A	22.5A
Output Current Adjustment Range ¹⁾	4.0-8.0A	5.0-10.0A	6.25-12.5A	6.5-13.0A	11.25-22.5A
Output Power	96W	120W	150W	156W	270W
Line Regulation	± 0.5% (@ 90-264Vac)				
Load Regulation (0-95% Load)	± 2% (@ 90-264Vac)				
PARD (20MHz)	< 150mVpp				
Hold-up Time	16ms typ. @ 115Vac & 230Vac (100% load)				
INPUT					
Input Voltage Range	90-264Vac				
Input Frequency	47-63Hz				
Input Current	1.30A max. @ 115Vac, 0.65A max. @ 230Vac	1.50A max. @ 115Vac, 0.70A max. @ 230Vac	1.80A max. @ 115Vac, 0.85A max. @ 230Vac	1.90A max. @ 115Vac, 0.90A max. @ 230Vac	3.50A max. @ 115Vac, 1.65A max. @ 230Vac
Efficiency at 100% Load	90.0% typ. @ 115Vac, 92.0% typ. @ 230Vac	90.0% typ. @ 115Vac, 92.0% typ. @ 230Vac	89.0% typ. @ 115Vac, 91.5% typ. @ 230Vac	89.0% typ. @ 115Vac, 91.5% typ. @ 230Vac	89.5% typ. @ 115Vac, 90.5% typ. @ 230Vac
Max Inrush Current (Cold Start)	65A typ. @ 230Vac				
Power Factor	0.98 typ. @ 115Vac, 0.95 typ. @ 230Vac				
Leakage Current	< 0.75mA @ 264Vac				< 0.75mA @ 277Vac
MECHANICAL					
Case Cover / Chassis	Aluminium				
Dimensions (L x W x H)	220 x 68 x 38.8 mm (8.66" x 2.68" x 1.53")	220 x 68 x 38.8 mm (8.66" x 2.68" x 1.53")	228 x 68 x 38.8 mm (8.98" x 2.68" x 1.53")	228 x 68 x 38.8 mm (8.98" x 2.68" x 1.53")	252 x 90 x 43.8 mm (9.92" x 3.54" x 1.72")
Unit Weight	0.98 kg (2.16 lb)	0.98 kg (2.16 lb)	1.04 kg (2.29 lb)	1.04 kg (2.29 lb)	1.70 kg (3.75 lb)
Cooling System	Convection				
Input Cable	VDE	H05RN-F3G1.0mm ² (Line: Brown, Neutral: Blue, PE: Green/Yellow)			
Output Cable	VDE	H07RN-F2x1.5mm ² (Positive: Red, Negative: Black)			
Dimming Cable	VDE	H05RN-F2x1.0mm ² (Positive: White, Negative: Blue)			
MTBF ²⁾	> 700,000 hrs	> 700,000 hrs	> 700,000 hrs	> 700,000 hrs	> 700,000 hrs
ENVIRONMENT					
Operating Temperature	-40°C to +70°C				
Storage Temperature	-40°C to +85°C				
Power De-rating ³⁾	> 60°C (4% / °C)				
Operating Humidity	5 to 95% RH (Non-Condensing)				
Operating Altitude	0 to 3,000m (0 to 9,840 ft)				
Degree of Protection	IP65 (LNE-12V□□WA□□A); IP67 (LNE-12V320WB□□A, LNE-12V□□WD□□A)				

Dimensions Reference

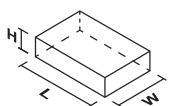

Notes

- 1) For LNE-□V□WA□□A package type only.
- 2) MTBF as per Telcordia SR-332 (I/P: 115Vac, O/P: 100% load).
- 3) Please refer to the technical datasheet for information about the mounting orientations.
- 4) All parameters are specified at 25°C ambient temperature unless otherwise indicated.

24V Output (North American AC Voltage)

LNE

HIGHLIGHTS & FEATURES

- Universal AC input voltage range 90-305Vac
- Up to 93.5% efficiency
- 6kV common mode & 4kV differential mode surge immunity
- Active PFC. Meets IEC/EN 61000-3-2, Class C
- Adjustable voltage & current; dimming option available
- IP65 or IP67 assembly for indoor and outdoor applications



GENERAL SPECIFICATIONS

OUTPUT	LNE-24V100W□AA	LNE-24V120W□AA	LNE-24V150W□AA	LNE-24V185W□AA	LNE-24V320W□AA
Nominal Output Voltage	24V	24V	24V	24V	24V
LED System Voltage Range in CC Mode	12-24Vdc	12-24Vdc	12-24Vdc	12-24Vdc	12-24Vdc
Output Voltage Adjustment Range ¹⁾	22.0-27.0V	22.0-27.0V	22.0-27.0V	22.0-27.0V	22.0-27.0V
Nominal Output Current	4.0A	5.0A	6.3A	7.8A	13.4A
Output Current Adjustment Range ¹⁾	2.0-4.0A	2.5-5.0A	3.15-6.3A	3.9-7.8A	6.67-13.4A
Output Power	96W	120W	151.2W	187.2W	320W
Line Regulation	± 0.5% (@ 90-305Vac)				
Load Regulation (0-95% Load)	± 1% (@ 90-305Vac)				± 0.5% (@ 90-305Vac)
PARD (20MHz)	< 150mVpp				
Hold-up Time	16ms typ. @ 115Vac & 230Vac & 277Vac (100% load)				
INPUT					
Input Voltage Range	90-305Vac				
Input Frequency	47-63Hz				
Input Current	1.30A max. @ 115Vac, 0.65A max. @ 230Vac, 0.60A max. @ 277Vac	1.50A max. @ 115Vac, 0.70A max. @ 230Vac, 0.65A max. @ 277Vac	1.80A max. @ 115Vac, 0.85A max. @ 230Vac, 0.80A max. @ 277Vac	2.20A max. @ 115Vac, 1.00A max. @ 230Vac, 0.90A max. @ 277Vac	3.50A max. @ 115Vac, 1.65A max. @ 230Vac, 1.45A max. @ 277Vac
Efficiency at 100% Load	92.0% typ. @ 115Vac, 93.0% typ. @ 230Vac & 277Vac	91.5% typ. @ 115Vac, 93.0% typ. @ 230Vac & 277Vac	91.5% typ. @ 115Vac, 93.0% typ. @ 230Vac & 277Vac	91.0% typ. @ 115Vac, 93.5% typ. @ 230Vac & 277Vac	91.5% typ. @ 115Vac, 93.5% typ. @ 230Vac, 94.0% typ. @ 277Vac
Max Inrush Current (Cold Start)	65A typ. @ 230Vac				
Power Factor	0.98 typ. @ 115Vac, 0.95 typ. @ 230Vac, 0.93 typ. @ 277Vac		0.98 typ. @ 115Vac, 0.95 typ. @ 230Vac, 0.92 typ. @ 277Vac		
Leakage Current	< 0.75mA @ 305Vac				< 0.75mA @ 277Vac
MECHANICAL					
Case Cover / Chassis	Aluminium				
Dimensions (L x W x H)	220 x 68 x 38.8 mm (8.66" x 2.68" x 1.53")	220 x 68 x 38.8 mm (8.66" x 2.68" x 1.53")	228 x 68 x 38.8 mm (8.98" x 2.68" x 1.53")	228 x 68 x 38.8 mm (8.98" x 2.68" x 1.53")	252 x 90 x 43.8 mm (9.92" x 3.54" x 1.72")
Unit Weight	0.98 kg (2.16 lb)	0.98 kg (2.16 lb)	1.04 kg (2.29 lb)	1.04 kg (2.29 lb)	1.70 kg (3.75 lb)
Cooling System	Convection				
Input Cable	UL	SJTW 18AWGX3C (Line: Brown, Neutral: Blue, PE: Green/Yellow)			
Output Cable	UL	SJTW 14AWGX2C (Positive: Red, Negative: Black)			
Dimming Cable	UL	SJTW 18AWGX2C (Positive: White, Negative: Blue)			
MTBF ²⁾	> 700,000 hrs	> 700,000 hrs	> 700,000 hrs	> 700,000 hrs	> 700,000 hrs
ENVIRONMENT					
Operating Temperature	-40°C to +70°C				
Storage Temperature	-40°C to +85°C				
Power De-rating ³⁾	> 60°C (4% / °C)				
Operating Humidity	5 to 95% RH (Non-Condensing)				
Operating Altitude	0 to 3,000m (0 to 9,840 ft)				
Degree of Protection	IP65 (LNE-24V□WA□A); IP67 (LNE-24V320WB□A, LNE-24V□WD□A)				

Dimensions Reference

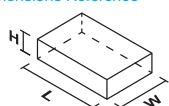

Notes

- 1) For LNE-□V□WA□A package type only.
- 2) MTBF as per Telcordia SR-332 (I/P: 115Vac, O/P: 100% load).
- 3) Please refer to the technical datasheet for information about the mounting orientations.
- 4) All parameters are specified at 25°C ambient temperature unless otherwise indicated.

LNE LED Driver

24V Output (International AC Voltage)

LNE

HIGHLIGHTS & FEATURES

- Meet ErP Directive (2009/125/EC) for 320W only
- Universal AC input voltage range 90-264Vac
- Up to 93.5% efficiency
- 6kV common mode & 4kV differential mode surge immunity
- Active PFC. Meets IEC/EN 61000-3-2, Class C
- Adjustable voltage & current; dimming option available
- IP65 or IP67 assembly for indoor and outdoor applications



GENERAL SPECIFICATIONS

OUTPUT	LNE-24V100W□□A	LNE-24V120W□□A	LNE-24V150W□□A	LNE-24V185W□□A	LNE-24V320W□□A
Nominal Output Voltage	24V	24V	24V	24V	24V
LED System Voltage Range in CC Mode	12-24Vdc	12-24Vdc	12-24Vdc	12-24Vdc	12-24Vdc
Output Voltage Adjustment Range ¹⁾	22.0-27.0V	22.0-27.0V	22.0-27.0V	22.0-27.0V	22.0-27.0V
Nominal Output Current	4.0A	5.0A	6.3A	7.8A	13.4A
Output Current Adjustment Range ¹⁾	2.0-4.0A	2.5-5.0A	3.15-6.3A	3.9-7.8A	6.67-13.4A
Output Power	96W	120W	151.2W	187.2W	320W
Line Regulation	± 0.5% (@ 90-264Vac)				
Load Regulation (0-95% Load)	± 1% (@ 90-264Vac)				± 0.5% (@ 90-264Vac)
PARD (20MHz)	< 150mVpp				
Hold-up Time	16ms typ. @ 115Vac & 230Vac (100% load)				
INPUT					
Input Voltage Range	90-264Vac				
Input Frequency	47-63Hz				
Input Current	1.30A max. @ 115Vac, 0.65A max. @ 230Vac	1.50A max. @ 115Vac, 0.70A max. @ 230Vac	1.80A max. @ 115Vac, 0.85A max. @ 230Vac	2.20A max. @ 115Vac, 1.00A max. @ 230Vac	3.50A max. @ 115Vac, 1.65A max. @ 230Vac
Efficiency at 100% Load	92.0% typ. @ 115Vac, 93.0% typ. @ 230Vac	91.5% typ. @ 115Vac, 93.0% typ. @ 230Vac	91.5% typ. @ 115Vac, 93.0% typ. @ 230Vac	91.0% typ. @ 115Vac, 93.5% typ. @ 230Vac	91.5% typ. @ 115Vac, 93.5% typ. @ 230Vac
Max Inrush Current (Cold Start)	65A typ. @ 230Vac				
Power Factor	0.98 typ. @ 115Vac, 0.95 typ. @ 230Vac				
Leakage Current	< 0.75mA @ 264Vac				< 0.75mA @ 277Vac
MECHANICAL					
Case Cover / Chassis	Aluminium				
Dimensions (L x W x H)	220 x 68 x 38.8 mm (8.66" x 2.68" x 1.53")	220 x 68 x 38.8 mm (8.66" x 2.68" x 1.53")	228 x 68 x 38.8 mm (8.98" x 2.68" x 1.53")	228 x 68 x 38.8 mm (8.98" x 2.68" x 1.53")	252 x 90 x 43.8 mm (9.92" x 3.54" x 1.72")
Unit Weight	0.98 kg (2.16 lb)	0.98 kg (2.16 lb)	1.04 kg (2.29 lb)	1.04 kg (2.29 lb)	1.70 kg (3.75 lb)
Cooling System	Convection				
Input Cable	VDE	H05RN-F3G1.0mm ² (Line: Brown, Neutral: Blue, PE: Green/Yellow)			
Output Cable	VDE	H07RN-F2x1.5mm ² (Positive: Red, Negative: Black)			
Dimming Cable	VDE	H05RN-F2x1.0mm ² (Positive: White, Negative: Blue)			
MTBF ²⁾	> 700,000 hrs	> 700,000 hrs	> 700,000 hrs	> 700,000 hrs	> 700,000 hrs
ENVIRONMENT					
Operating Temperature	-40°C to +70°C				
Storage Temperature	-40°C to +85°C				
Power De-rating ³⁾	> 60°C (4% / °C)				
Operating Humidity	5 to 95% RH (Non-Condensing)				
Operating Altitude	0 to 3,000m (0 to 9,840 ft)				
Degree of Protection	IP65 (LNE-24V□□WA□□A); IP67 (LNE-24V320WB□□A, LNE-24V□□WD□□A)				

Dimensions Reference

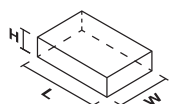

Notes

- 1) For LNE-□V□WA□□A package type only.
- 2) MTBF as per Telcordia SR-332 (I/P: 115Vac, O/P: 100% load).
- 3) Please refer to the technical datasheet for information about the mounting orientations.
- 4) All parameters are specified at 25°C ambient temperature unless otherwise indicated.

36V Output (North American AC Voltage)

LNE

HIGHLIGHTS & FEATURES

- Universal AC input voltage range 90-305Vac
- Up to 93.5% efficiency
- 6kV common mode & 4kV differential mode surge immunity
- Active PFC. Meets IEC/EN 61000-3-2, Class C
- Adjustable voltage & current; dimming option available
- IP65 or IP67 assembly for indoor and outdoor applications



GENERAL SPECIFICATIONS

OUTPUT	LNE-36V100W□AA	LNE-36V120W□AA	LNE-36V150W□AA	LNE-36V185W□AA	LNE-36V320W□AA
Nominal Output Voltage	36V	36V	36V	36V	36V
LED System Voltage Range in CC Mode	18-36Vdc	18-36Vdc	18-36Vdc	18-36Vdc	18-36Vdc
Output Voltage Adjustment Range ¹⁾	33.0-40.0V	33.0-40.0V	33.0-40.0V	33.0-40.0V	33.0-40.0V
Nominal Output Current	2.65A	3.4A	4.2A	5.2A	8.9A
Output Current Adjustment Range ¹⁾	1.325-2.65A	1.7-3.4A	2.1-4.2A	2.6-5.2A	4.45-8.9A
Output Power	95.4W	122.4W	151.2W	187.2W	320W
Line Regulation	± 0.5% (@ 90-305Vac)				
Load Regulation (0-95% Load)	± 0.5% (@ 90-305Vac)		± 1% (@ 90-305Vac)		± 0.5% (@ 90-305Vac)
PAR (20MHz)	< 200mVpp				
Hold-up Time	16ms typ. @ 115Vac & 230Vac & 277Vac (100% load)				
INPUT					
Input Voltage Range	90-305Vac				
Input Frequency	47-63Hz				
Input Current	1.30A max. @ 115Vac, 0.65A max. @ 230Vac, 0.60A max. @ 277Vac	1.50A max. @ 115Vac, 0.70A max. @ 230Vac, 0.65A max. @ 277Vac	1.80A max. @ 115Vac, 0.85A max. @ 230Vac, 0.80A max. @ 277Vac	2.20A max. @ 115Vac, 1.00A max. @ 230Vac, 0.90A max. @ 277Vac	3.50A max. @ 115Vac, 1.65A max. @ 230Vac, 1.45A max. @ 277Vac
Efficiency at 100% Load	91.5% typ. @ 115Vac, 93.0% typ. @ 230Vac, 92.5% typ. @ 277Vac	91.5% typ. @ 115Vac, 93.0% typ. @ 230Vac & 277Vac	91.0% typ. @ 115Vac, 93.5% typ. @ 230Vac, 93.0% typ. @ 277Vac	91.0% typ. @ 115Vac, 93.5% typ. @ 230Vac & 277Vac	92.5% typ. @ 115Vac, 94.5% typ. @ 230Vac & 277Vac
Max Inrush Current (Cold Start)	65A typ. @ 230Vac				
Power Factor	0.98 typ. @ 115Vac, 0.95 typ. @ 230Vac, 0.93 typ. @ 277Vac		0.98 typ. @ 115Vac, 0.95 typ. @ 230Vac, 0.92 typ. @ 277Vac		
Leakage Current	< 0.75mA @ 305Vac				< 0.75mA @ 277Vac
MECHANICAL					
Case Cover / Chassis	Aluminium				
Dimensions (L x W x H)	220 x 68 x 38.8 mm (8.66" x 2.68" x 1.53")	220 x 68 x 38.8 mm (8.66" x 2.68" x 1.53")	228 x 68 x 38.8 mm (8.98" x 2.68" x 1.53")	228 x 68 x 38.8 mm (8.98" x 2.68" x 1.53")	252 x 90 x 43.8 mm (9.92" x 3.54" x 1.72")
Unit Weight	0.98 kg (2.16 lb)	0.98 kg (2.16 lb)	1.04 kg (2.29 lb)	1.04 kg (2.29 lb)	1.70 kg (3.75 lb)
Cooling System	Convection				
Input Cable	UL	SJTW 18AWGX3C (Line: Brown, Neutral: Blue, PE: Green/Yellow)			
Output Cable	UL	SJTW 14AWGX2C (Positive: Red, Negative: Black)			
Dimming Cable	UL	SJTW 18AWGX2C (Positive: White, Negative: Blue)			
MTBF ²⁾	> 700,000 hrs	> 700,000 hrs	> 700,000 hrs	> 700,000 hrs	> 700,000 hrs
ENVIRONMENT					
Operating Temperature	-40°C to +70°C				
Storage Temperature	-40°C to +85°C				
Power De-rating ³⁾	> 60°C (4% / °C)				
Operating Humidity	5 to 95% RH (Non-Condensing)				
Operating Altitude	0 to 3,000m (0 to 9,840 ft)				
Degree of Protection	IP65 (LNE-36V□WA□A); IP67 (LNE-36V320WB□A, LNE-36V□WD□A)				

Dimensions Reference

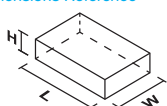

Notes

- 1) For LNE-□V□WA□A package type only.
- 2) MTBF as per Telcordia SR-332 (I/P: 115Vac, O/P: 100% load).
- 3) Please refer to the technical datasheet for information about the mounting orientations.
- 4) All parameters are specified at 25°C ambient temperature unless otherwise indicated.

LNE LED Driver

36V Output (International AC Voltage)

LNE

HIGHLIGHTS & FEATURES

- Meet ErP Directive (2009/125/EC) for 320W only
- Universal AC input voltage range 90-264Vac
- Up to 93.5% efficiency
- 6kV common mode & 4kV differential mode surge immunity
- Active PFC. Meets IEC/EN 61000-3-2, Class C
- Adjustable voltage & current; dimming option available
- IP65 or IP67 assembly for indoor and outdoor applications



GENERAL SPECIFICATIONS

OUTPUT	LNE-36V100W□□A	LNE-36V120W□□A	LNE-36V150W□□A	LNE-36V185W□□A	LNE-36V320W□□A
Nominal Output Voltage	36V	36V	36V	36V	36V
LED System Voltage Range in CC Mode	18-36Vdc	18-36Vdc	18-36Vdc	18-36Vdc	18-36Vdc
Output Voltage Adjustment Range ¹⁾	33.0-40.0V	33.0-40.0V	33.0-40.0V	33.0-40.0V	33.0-40.0V
Nominal Output Current	2.65A	3.4A	4.2A	5.2A	8.9A
Output Current Adjustment Range ¹⁾	1.325-2.65A	1.7-3.4A	2.1-4.2A	2.6-5.2A	4.45-8.9A
Output Power	95.4W	122.4W	151.2W	187.2W	320W
Line Regulation	± 0.5% (@ 90-264Vac)				
Load Regulation (0-95% Load)	± 0.5% (@ 90-264Vac)		± 1% (@ 90-264Vac)		± 0.5% (@ 90-264Vac)
PARD (20MHz)	< 200mVpp				
Hold-up Time	16ms typ. @ 115Vac & 230Vac (100% load)				
INPUT					
Input Voltage Range	90-264Vac				
Input Frequency	47-63Hz				
Input Current	1.30A max. @ 115Vac, 0.65A max. @ 230Vac	1.50A max. @ 115Vac, 0.70A max. @ 230Vac	1.80A max. @ 115Vac, 0.85A max. @ 230Vac	2.20A max. @ 115Vac, 1.00A max. @ 230Vac	3.50A max. @ 115Vac, 1.65A max. @ 230Vac
Efficiency at 100% Load	91.5% typ. @ 115Vac, 93.0% typ. @ 230Vac	91.5% typ. @ 115Vac, 93.0% typ. @ 230Vac	91.0% typ. @ 115Vac, 93.0% typ. @ 230Vac	91.0% typ. @ 115Vac, 93.5% typ. @ 230Vac	92.5% typ. @ 115Vac, 94.5% typ. @ 230Vac
Max Inrush Current (Cold Start)	65A typ. @ 230Vac				
Power Factor	0.98 typ. @ 115Vac, 0.95 typ. @ 230Vac				
Leakage Current	< 0.75mA @ 264Vac				< 0.75mA @ 277Vac
MECHANICAL					
Case Cover / Chassis	Aluminium				
Dimensions (L × W × H)	220 × 68 × 38.8 mm (8.66" × 2.68" × 1.53")	220 × 68 × 38.8 mm (8.66" × 2.68" × 1.53")	228 × 68 × 38.8 mm (8.98" × 2.68" × 1.53")	228 × 68 × 38.8 mm (8.98" × 2.68" × 1.53")	252 × 90 × 43.8 mm (9.92" × 3.54" × 1.72")
Unit Weight	0.98 kg (2.16 lb)	0.98 kg (2.16 lb)	1.04 kg (2.29 lb)	1.04 kg (2.29 lb)	1.70 kg (3.75 lb)
Cooling System	Convection				
Input Cable	VDE	H05RN-F3G1.0mm ² (Line: Brown, Neutral: Blue, PE: Green/Yellow)			
Output Cable	VDE	H07RN-F2x1.5mm ² (Positive: Red, Negative: Black)			
Dimming Cable	VDE	H05RN-F2x1.0mm ² (Positive: White, Negative: Blue)			
MTBF ²⁾	> 700,000 hrs	> 700,000 hrs	> 700,000 hrs	> 700,000 hrs	> 700,000 hrs
ENVIRONMENT					
Operating Temperature	-40°C to +70°C				
Storage Temperature	-40°C to +85°C				
Power De-rating ³⁾	> 60°C (4% / °C)				
Operating Humidity	5 to 95% RH (Non-Condensing)				
Operating Altitude	0 to 3,000m (0 to 9,840 ft)				
Degree of Protection	IP65 (LNE-36V□□A□□A); IP67 (LNE-36V320W□□A, LNE-36V□□W□□A)				

Dimensions Reference

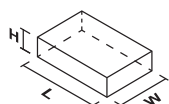

Notes

- 1) For LNE-□V□W□□A package type only.
- 2) MTBF as per Telcordia SR-332 (I/P: 115Vac, O/P: 100% load).
- 3) Please refer to the technical datasheet for information about the mounting orientations.
- 4) All parameters are specified at 25°C ambient temperature unless otherwise indicated.

48V Output (North American AC Voltage)

LNE

HIGHLIGHTS & FEATURES

- Universal AC input voltage range 90-305Vac
- Up to 94% efficiency
- 6kV common mode & 4kV differential mode surge immunity
- Active PFC. Meets IEC/EN 61000-3-2, Class C
- Adjustable voltage & current; dimming option available
- IP65 or IP67 assembly for indoor and outdoor applications



GENERAL SPECIFICATIONS

OUTPUT	LNE-48V100W□AA	LNE-48V120W□AA	LNE-48V150W□AA	LNE-48V185W□AA	LNE-48V320W□AA
Nominal Output Voltage	48V	48V	48V	48V	48V
LED System Voltage Range in CC Mode	24-48Vdc	24-48Vdc	24-48Vdc	24-48Vdc	24-48Vdc
Output Voltage Adjustment Range ¹⁾	43.0-53.0V	43.0-53.0V	43.0-53.0V	43.0-53.0V	43.0-53.0V
Nominal Output Current	2.0A	2.5A	3.2A	3.9A	6.7A
Output Current Adjustment Range ¹⁾	1.0-2.0A	1.25-2.5A	1.6-3.2A	1.95-3.9A	3.35-6.7A
Output Power	96W	120W	153.6W	187.2W	320W
Line Regulation	± 0.5% (@ 90-305Vac)				
Load Regulation (0-95% Load)	± 0.5% (@ 90-305Vac)				
PARD (20MHz)	< 200mVpp				< 250mVpp
Hold-up Time	16ms typ. @ 115Vac & 230Vac & 277Vac (100% load)				
INPUT					
Input Voltage Range	90-305Vac				
Input Frequency	47-63Hz				
Input Current	1.30A max. @ 115Vac, 0.65A max. @ 230Vac, 0.60A max. @ 277Vac	1.50A max. @ 115Vac, 0.70A max. @ 230Vac, 0.65A max. @ 277Vac	1.80A max. @ 115Vac, 0.85A max. @ 230Vac, 0.80A max. @ 277Vac	2.20A max. @ 115Vac, 1.00A max. @ 230Vac, 0.90A max. @ 277Vac	3.50A max. @ 115Vac, 1.65A max. @ 230Vac, 1.45A max. @ 277Vac
Efficiency at 100% Load	92.0% typ. @ 115Vac, 93.0% typ. @ 230Vac & 277Vac	92.0% typ. @ 115Vac, 93.5% typ. @ 230Vac & 277Vac	91.5% typ. @ 115Vac, 94.0% typ. @ 230Vac & 277Vac	91.5% typ. @ 115Vac, 94.0% typ. @ 230Vac & 277Vac	93.0% typ. @ 115Vac, 94.5% typ. @ 230Vac & 277Vac
Max Inrush Current (Cold Start)	65A typ. @ 230Vac				
Power Factor	0.98 typ. @ 115Vac, 0.95 typ. @ 230Vac, 0.93 typ. @ 277Vac		0.98 typ. @ 115Vac, 0.95 typ. @ 230Vac, 0.92 typ. @ 277Vac		
Leakage Current	< 0.75mA @ 305Vac				< 0.75mA @ 277Vac
MECHANICAL					
Case Cover / Chassis	Aluminium				
Dimensions (L x W x H)	220 x 68 x 38.8 mm (8.66" x 2.68" x 1.53")	220 x 68 x 38.8 mm (8.66" x 2.68" x 1.53")	228 x 68 x 38.8 mm (8.98" x 2.68" x 1.53")	228 x 68 x 38.8 mm (8.98" x 2.68" x 1.53")	252 x 90 x 43.8 mm (9.92" x 3.54" x 1.72")
Unit Weight	0.98 kg (2.16 lb)	0.98 kg (2.16 lb)	1.04 kg (2.29 lb)	1.04 kg (2.29 lb)	1.70 kg (3.75 lb)
Cooling System	Convection				
Input Cable	UL	SJTW 18AWGX3C (Line: Brown, Neutral: Blue, PE: Green/Yellow)			
Output Cable	UL	SJTW 14AWGX2C (Positive: Red, Negative: Black)			
Dimming Cable	UL	SJTW 18AWGX2C (Positive: White, Negative: Blue)			
MTBF ²⁾	> 700,000 hrs	> 700,000 hrs	> 700,000 hrs	> 700,000 hrs	> 700,000 hrs
ENVIRONMENT					
Operating Temperature	-40°C to +70°C				
Storage Temperature	-40°C to +85°C				
Power De-rating ³⁾	> 60°C (4% / °C)				
Operating Humidity	5 to 95% RH (Non-Condensing)				
Operating Altitude	0 to 3,000m (0 to 9,840 ft)				
Degree of Protection	IP65 (LNE-48V□WA□A); IP67 (LNE-48V320WB□A, LNE-48V□WD□A)				

Dimensions Reference

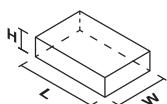

Notes

- 1) For LNE-□V□WA□A package type only.
- 2) MTBF as per Telcordia SR-332 (I/P: 115Vac, O/P: 100% load).
- 3) Please refer to the technical datasheet for information about the mounting orientations.
- 4) All parameters are specified at 25°C ambient temperature unless otherwise indicated.

LNE LED Driver

48V Output (International AC Voltage)

LNE

HIGHLIGHTS & FEATURES

- Meet ErP Directive (2009/125/EC) for 320W only
- Universal AC input voltage range 90-264Vac
- Up to 94% efficiency
- 6kV common mode & 4kV differential mode surge immunity
- Active PFC. Meets IEC/EN 61000-3-2, Class C
- Adjustable voltage & current; dimming option available
- IP65 or IP67 assembly for indoor and outdoor applications



GENERAL SPECIFICATIONS

OUTPUT	LNE-48V100W□□A	LNE-48V120W□□A	LNE-48V150W□□A	LNE-48V185W□□A	LNE-48V320W□□A
Nominal Output Voltage	48V	48V	48V	48V	48V
LED System Voltage Range in CC Mode	24-48Vdc	24-48Vdc	24-48Vdc	24-48Vdc	24-48Vdc
Output Voltage Adjustment Range ¹⁾	43.0-53.0V	43.0-53.0V	43.0-53.0V	43.0-53.0V	43.0-53.0V
Nominal Output Current	2.0A	2.5A	3.2A	3.9A	6.7A
Output Current Adjustment Range ¹⁾	1.0-2.0A	1.25-2.5A	1.6-3.2A	1.95-3.9A	3.35-6.7A
Output Power	96W	120W	153.6W	187.2W	320W
Line Regulation	± 0.5% (@ 90-264Vac)				
Load Regulation (0-95% Load)	± 0.5% (@ 90-264Vac)				
PARD (20MHz)	< 200mVpp				
Hold-up Time	16ms typ. @ 115Vac & 230Vac (100% load)				
INPUT					
Input Voltage Range	90-264Vac				
Input Frequency	47-63Hz				
Input Current	1.30A max. @ 115Vac, 0.65A max. @ 230Vac	1.50A max. @ 115Vac, 0.70A max. @ 230Vac	1.80A max. @ 115Vac, 0.85A max. @ 230Vac	2.20A max. @ 115Vac, 1.00A max. @ 230Vac	3.50A max. @ 115Vac, 1.65A max. @ 230Vac
Efficiency at 100% Load	92.0% typ. @ 115Vac, 93.0% typ. @ 230Vac	92.0% typ. @ 115Vac, 93.5% typ. @ 230Vac	91.5% typ. @ 115Vac, 94.0% typ. @ 230Vac	91.5% typ. @ 115Vac, 94.0% typ. @ 230Vac	93.0% typ. @ 115Vac, 94.5% typ. @ 230Vac
Max Inrush Current (Cold Start)	65A typ. @ 230Vac				
Power Factor	0.98 typ. @ 115Vac, 0.95 typ. @ 230Vac				
Leakage Current	< 0.75mA @ 264Vac				
MECHANICAL					
Case Cover / Chassis	Aluminium				
Dimensions (L x W x H)	220 x 68 x 38.8 mm (8.66" x 2.68" x 1.53")	220 x 68 x 38.8 mm (8.66" x 2.68" x 1.53")	228 x 68 x 38.8 mm (8.98" x 2.68" x 1.53")	228 x 68 x 38.8 mm (8.98" x 2.68" x 1.53")	252 x 90 x 43.8 mm (9.92" x 3.54" x 1.72")
Unit Weight	0.98 kg (2.16 lb)	0.98 kg (2.16 lb)	1.04 kg (2.29 lb)	1.04 kg (2.29 lb)	1.70 kg (3.75 lb)
Cooling System	Convection				
Input Cable	VDE	H05RN-F3G1.0mm ² (Line: Brown, Neutral: Blue, PE: Green/Yellow)			
Output Cable	VDE	H07RN-F2x1.5mm ² (Positive: Red, Negative: Black)			
Dimming Cable	VDE	H05RN-F2x1.0mm ² (Positive: White, Negative: Blue)			
MTBF ²⁾	> 700,000 hrs	> 700,000 hrs	> 700,000 hrs	> 700,000 hrs	> 700,000 hrs
ENVIRONMENT					
Operating Temperature	-40°C to +70°C				
Storage Temperature	-40°C to +85°C				
Power De-rating ³⁾	> 60°C (4% / °C)				
Operating Humidity	5 to 95% RH (Non-Condensing)				
Operating Altitude	0 to 3,000m (0 to 9,840 ft)				
Degree of Protection	IP65 (LNE-48V□□WA□□A); IP67 (LNE-48V320WB□□A, LNE-48V□WD□□A)				

Dimensions Reference

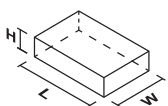

Notes

- 1) For LNE-□V□WA□□A package type only.
- 2) MTBF as per Telcordia SR-332 (I/P: 115Vac, O/P: 100% load).
- 3) Please refer to the technical datasheet for information about the mounting orientations.
- 4) All parameters are specified at 25°C ambient temperature unless otherwise indicated.

54V Output (North American AC Voltage)

LNE

HIGHLIGHTS & FEATURES

- Universal AC input voltage range 90-305Vac
- Up to 94% efficiency
- 6kV common mode & 4kV differential mode surge immunity
- Active PFC. Meets IEC/EN 61000-3-2, Class C
- Adjustable voltage & current; dimming option available
- IP65 or IP67 assembly for indoor and outdoor applications



GENERAL SPECIFICATIONS

OUTPUT	LNE-54V150W□AA	LNE-54V185W□AA
Nominal Output Voltage	54V	54V
LED System Voltage Range in CC Mode	27-54Vdc	27-54Vdc
Output Voltage Adjustment Range ¹⁾	49.0-58.0V	49.0-58.0V
Nominal Output Current	2.8A	3.45A
Output Current Adjustment Range ¹⁾	1.4-2.8A	1.725-3.45A
Output Power	151.2W	186.3W
Line Regulation		± 0.5% (@ 90-305Vac)
Load Regulation (0-95% Load)		± 0.5% (@ 90-305Vac)
PARD (20MHz)		< 200mVpp
Hold-up Time		16ms typ. @ 115Vac & 230Vac & 277Vac (100% load)
INPUT		
Input Voltage Range		90-305Vac
Input Frequency		47-63Hz
Input Current	1.80A max. @ 115Vac, 0.85A max. @ 230Vac, 0.80A max. @ 277Vac	2.20A max. @ 115Vac, 1.00A max. @ 230Vac, 0.90A max. @ 277Vac
Efficiency at 100% Load	91.5% typ. @ 115Vac, 94.0% typ. @ 230Vac & 277Vac	91.5% typ. @ 115Vac, 94.0% typ. @ 230Vac & 277Vac
Max Inrush Current (Cold Start)		65A typ. @ 230Vac
Power Factor		0.98 typ. @ 115Vac, 0.95 typ. @ 230Vac, 0.92 typ. @ 277Vac
Leakage Current		< 0.75mA @ 305Vac
MECHANICAL		
Case Cover / Chassis		Aluminium
Dimensions (L x W x H)	228 × 68 × 38.8 mm (8.98" × 2.68" × 1.53")	228 × 68 × 38.8 mm (8.98" × 2.68" × 1.53")
Unit Weight	1.04 kg (2.29 lb)	1.04 kg (2.29 lb)
Cooling System		Convection
Input Cable	UL	SJTW 18AWGX3C (Line: Brown, Neutral: Blue, PE: Green/Yellow)
Output Cable	UL	SJTW 14AWGX2C (Positive: Red, Negative: Black)
Dimming Cable	UL	SJTW 18AWGX2C (Positive: White, Negative: Blue)
MTBF ²⁾	> 700,000 hrs	> 700,000 hrs
ENVIRONMENT		
Operating Temperature		-40°C to +70°C
Storage Temperature		-40°C to +85°C
Power De-rating ³⁾		> 60°C (4% / °C)
Operating Humidity		5 to 95% RH (Non-Condensing)
Operating Altitude		0 to 3,000m (0 to 9,840 ft)
Degree of Protection		IP65 (LNE-54V□WA□A); IP67 (LNE-54V□WD□A)

Dimensions Reference

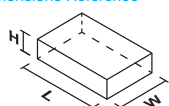

Notes

- 1) For LNE-□V□WA□A package type only.
- 2) MTBF as per Telcordia SR-332 (I/P: 115Vac, O/P: 100% load).
- 3) Please refer to the technical datasheet for information about the mounting orientations.
- 4) All parameters are specified at 25°C ambient temperature unless otherwise indicated.

LNE LED Driver

54V Output (International AC Voltage)



LNE

HIGHLIGHTS & FEATURES

- Universal AC input voltage range 90-264Vac
- Up to 94% efficiency
- 6kV common mode & 4kV differential mode surge immunity
- Active PFC. Meets IEC/EN 61000-3-2, Class C
- Adjustable voltage & current; dimming option available
- IP65 or IP67 assembly for indoor and outdoor applications



GENERAL SPECIFICATIONS

OUTPUT	LNE-54V150W□□CA	LNE-54V185W□□CA
Nominal Output Voltage	54V	54V
LED System Voltage Range in CC Mode	27-54Vdc	27-54Vdc
Output Voltage Adjustment Range ¹⁾	49.0-58.0V	49.0-58.0V
Nominal Output Current	2.8A	3.45A
Output Current Adjustment Range ¹⁾	1.40-2.8A	1.725-3.45A
Output Power	151.2W	186.3W
Line Regulation	± 0.5% (@ 90-264Vac)	
Load Regulation (0-95% Load)	± 0.5% (@ 90-264Vac)	
PARD (20MHz)	< 200mVpp	
Hold-up Time	16ms typ. @ 115Vac & 230Vac (100% load)	
INPUT		
Input Voltage Range	90-264Vac	
Input Frequency	47-63Hz	
Input Current	1.80A max. @ 115Vac, 0.85A max. @ 230Vac	2.20A max. @ 115Vac, 1.00A max. @ 230Vac
Efficiency at 100% Load	91.5% typ. @ 115Vac, 94.0% typ. @ 230Vac	91.5% typ. @ 115Vac, 94.0% typ. @ 230Vac
Max Inrush Current (Cold Start)	65A typ. @ 230Vac	
Power Factor	0.98 typ. @ 115Vac, 0.95 typ. @ 230Vac	
Leakage Current	< 0.75mA @ 264Vac	
MECHANICAL		
Case Cover / Chassis	Aluminium	
Dimensions (L x W x H)	228 × 68 × 38.8 mm (8.98" × 2.68" × 1.53")	228 × 68 × 38.8 mm (8.98" × 2.68" × 1.53")
Unit Weight	1.04 kg (2.29 lb)	1.04 kg (2.29 lb)
Cooling System	Convection	
Input Cable	VDE	H05RN-F3G1.0mm ² (Line: Brown, Neutral: Blue, PE: Green/Yellow)
Output Cable	VDE	H07RN-F2x1.5mm ² (Positive: Red, Negative: Black)
Dimming Cable	VDE	H05RN-F2x1.0mm ² (Positive: White, Negative: Blue)
MTBF ²⁾	> 700,000 hrs	> 700,000 hrs
ENVIRONMENT		
Operating Temperature	-40°C to +70°C	
Storage Temperature	-40°C to +85°C	
Power De-rating ³⁾	> 60°C (4% / °C)	
Operating Humidity	5 to 95% RH (Non-Condensing)	
Operating Altitude	0 to 3,000m (0 to 9,840 ft)	
Degree of Protection	IP65 (LNE-54V□□WA□□A); IP67 (LNE-54V□□WD□□A)	

Dimensions Reference

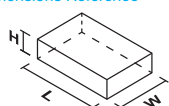

Notes

- 1) For LNE-□V□□WA□□A package type only.
- 2) MTBF as per Telcordia SR-332 (I/P: 115Vac, O/P: 100% load).
- 3) Please refer to the technical datasheet for information about the mounting orientations.
- 4) All parameters are specified at 25°C ambient temperature unless otherwise indicated.

LNV LED Driver

12V, 24V, 36V, 48V Output

LNV

HIGHLIGHTS & FEATURES

- Designed for single phase (for L – N) or two phase (for L – L) wide input 180-528Vac
- Up to 94.0% efficiency
- 6kV common mode & 4kV differential mode surge immunity
- Active PFC. Meets IEC/EN 61000-3-2, Class C
- Adjustable voltage & current; dimming option available
- IP65 or IP67 assembly for indoor and outdoor applications



GENERAL SPECIFICATIONS

OUTPUT	LNV-12V320W□AA	LNV-24V320W□AA	LNV-36V320W□AA	LNV-48V320W□AA
Nominal Output Voltage	12Vdc	24Vdc	36Vdc	48Vdc
LED System Voltage Range in CC Mode	6-12Vdc	12-24Vdc	18-36Vdc	24-48Vdc
Output Voltage Adjustment Range ¹⁾	10.8-13.5V	22.0-27.0V	33.0-40.0V	43.0-53.0V
Nominal Output Current	22.5A	13.4A	8.9A	6.7A
Output Current Adjustment Range ¹⁾	11.25-22.5A	6.67-13.4A	4.45-8.9A	3.35-6.7A
Output Power	270W	320W	320W	320W
Line Regulation	± 0.5% (@ 180-528Vac)			
Load Regulation (0-95% Load)	± 2% (@ 180-528Vac)		± 0.5% (@ 180-528Vac)	
PARD (20MHz)	< 150mVpp		< 250mVpp	
Hold-up Time	16ms typ. @ 230Vac & 277Vac & 480Vac (100% load)			
INPUT				
Input Voltage Range	180-528Vac			
Input Frequency	47-63Hz			
Input Current	1.70A max. @ 230Vac, 1.40A max. @ 277Vac, 1.00A max. @ 480Vac			
Efficiency at 100% Load	88.0% typ. @ 230Vac, 88.5% typ. @ 277Vac, 89.0% typ. @ 480Vac	91.0% typ. @ 230Vac, 92.0% typ. @ 277Vac, 92.5% typ. @ 480Vac	92.0% typ. @ 230Vac, 92.5% typ. @ 277Vac, 93.0% typ. @ 480Vac	92.0% typ. @ 230Vac, 93.0% typ. @ 277Vac, 93.5% typ. @ 480Vac
Max Inrush Current (Cold Start)	50A typ. @ 480Vac			
Power Factor	0.98 typ. @ 230Vac & 277Vac, 0.95 typ. @ 480Vac			
Leakage Current	< 0.75mA @ 480Vac			
MECHANICAL				
Case Cover / Chassis	Aluminium			
Dimensions (L x W x H)	262 x 90 x 43.8 mm (10.32" x 3.54" x 1.72")	262 x 90 x 43.8 mm (10.32" x 3.54" x 1.72")	262 x 90 x 43.8 mm (10.32" x 3.54" x 1.72")	262 x 90 x 43.8 mm (10.32" x 3.54" x 1.72")
Unit Weight	1.19 kg (2.62 lb)	1.19 kg (2.62 lb)	1.19 kg (2.62 lb)	1.19 kg (2.62 lb)
Cooling System	Convection			
Input Cable	UL	SJTW 18AWGX3C (Line: Brown, Neutral: Blue, PE: Green/Yellow)		
Output Cable	UL	SJTW 14AWGX2C (Positive: Red, Negative: Black)		
Dimming Cable	UL	SJTW 18AWGX2C (Positive: White, Negative: Blue)		
MTBF ²⁾	> 700,000 hrs	> 700,000 hrs	> 700,000 hrs	> 700,000 hrs
ENVIRONMENT				
Operating Temperature	-40°C to +60°C (@ 180Vac); -40°C to +65°C (@ 230Vac); -40°C to +70°C (@ 270Vac and above)			
Storage Temperature	-40°C to +85°C			
Power De-rating ³⁾	> 50°C (4% / °C) @ 180Vac; > 55°C (4% / °C) @ 230Vac; > 60°C (4% / °C) @ 277Vac and above)			
Operating Humidity	5 to 95% RH (Non-Condensing)			
Operating Altitude	0 to 3,000m (0 to 9,840 ft)			
Degree of Protection	IP65 (LNV-□□WAAA) IP67 (LNV-□□WBAA, LNV-□□WDAA)			

Dimensions Reference

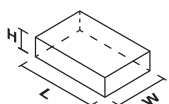

Notes

- 1) For LNV-□□WAAA package type only.
- 2) MTBF as per Telcordia SR-332 (I/P: 200Vac, O/P: 100% load).
- 3) Please refer to the technical datasheet for information about the mounting orientations.
- 4) All parameters are specified at 25°C ambient temperature unless otherwise indicated.

Delta LED Power Supplies

Open Frame Power Supply



AR

PJP

- Universal AC input voltage range
- Standard industrial footprint of 3" x 5"
- Low inrush current < 20A and up to 90.0% efficiency
- Low earth leakage current < 500 μ A
- Extreme low temperature operation at -40°C
- Safety approval according to UL 8750 and IEC/UL 60950-1



PJL Open Frame Power Supply

48V Output

PJL

HIGHLIGHTS & FEATURES

- Universal AC input voltage range
- Standard industrial footprint of 3" x 5"
- Low inrush current < 20A and up to 90.0% efficiency
- Low earth leakage current < 500μA
- Extreme low temperature operation at -40°C
- Safety approval according to UL 8750 and IEC/UL 60950-1



GENERAL SPECIFICATIONS

	COMING SOON	COMING SOON
OUTPUT	PJL-48V200WBAA	PJL-48V400WBAA
Output Voltage	48V	48V
Output Voltage Range	48-50Vdc	48-50Vdc
Output Current	0-4.17A	0-8.33A
Output Power	200W	400W
Line Regulation	± 1% typ. (@ 100-277Vac input, 0-100% load)	
Load Regulation	± 2% typ. (@ 100-277Vac input, 0-100% load)	
PARD (20MHz) ¹⁾	< 480mVpp	< 680mVpp
Hold-up Time	> 5ms @ 115Vac & 230Vac (100% load)	
INPUT		
Phase Input	Single Phase	
Input Voltage Range	85-305Vac	
Input Frequency	47-63Hz	
Input Current	< 2.20A @ 115Vac	< 4.74A @ 115Vac
Efficiency at 100% Load ²⁾	> 85% @ 115Vac, > 90% @ 230Vac	
Max Inrush Current (Cold Start)	< 20A @ 230Vac	
Power Factor	> 0.95 @ 115Vac & 230Vac	
Leakage Current	< 500μA	
MECHANICAL		
Case Cover / Chassis	-	
Dimensions (L x W x H)	127 × 76.2 × 34.6 mm (5.00" × 3.00" × 1.36")	127 × 76.6 × 39.1 mm (5.00" × 3.02" × 1.54")
Unit Weight	0.42 kg (0.93 lb)	0.44 kg (0.97 lb)
Cooling System	Convection: 0-150W Forced Air: 151-200W	Convection: 0-200W Forced Air: 201-400W
MTBF ³⁾	> 500,000 hrs	
ENVIRONMENT		
Operating Temperature	-40°C to +70°C	
Storage Temperature	-40°C to +85°C	
Power De-rating	> 50°C (2.5% / °C)	
Operating Humidity	5 to 95% RH (Non-Condensing)	
Operating Altitude	0 to 5,000m (0 to 16,400 ft)	

Dimensions Reference

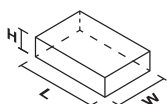

Notes

- 1) PARD is measured with an AC coupling mode, 5cm wires, and in parallel with 0.1μF ceramic capacitor & 47μF electrolytic capacitor.
- 2) At 25°C ambient temperature by vertical mounting orientation.
- 3) MTBF as per Telcordia SR-332 (Confidence level: 90%, I/P: 115Vac, O/P: 100% load).
- 4) All parameters are specified at 25°C ambient temperature unless otherwise indicated.

Accessories

L-01, L-02, L-03A, P-03

DIN Rail Accessories

L-01

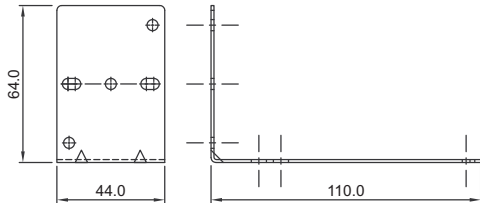

P-03

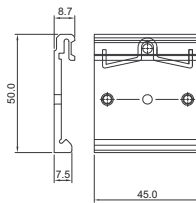

L-02

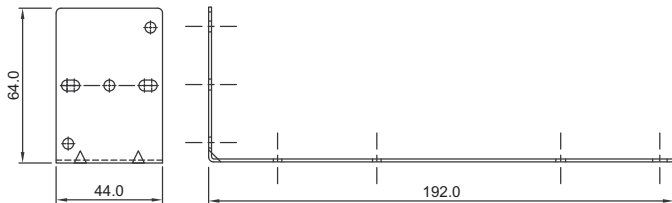

L-03A

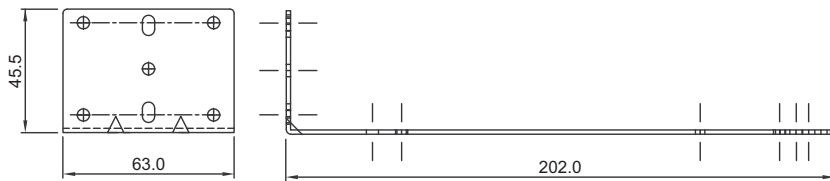

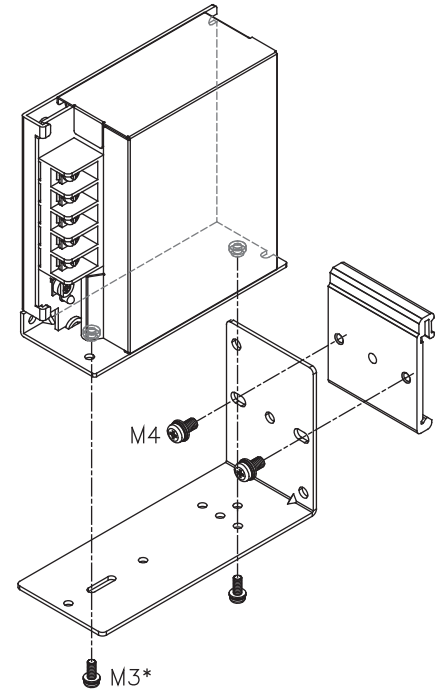

Accessories Assembly

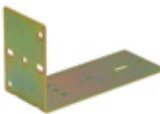
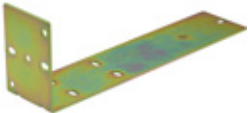
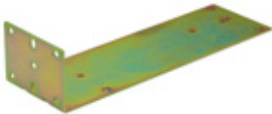

*Except PMC-24V300W1BA. Please use M4 screws only.

Model Information

Item	Model Number	Compatible Models
	L-01	PMC-05V015W1AA, PMC-05V035W1AA, PMC-05V050W1AA PMC-12V035W1AA, PMC-12V050W1AA, PMC-12V060W1NA PMC-24V035W1A□, PMC-24V050W1A□, PMC-24V075W1A□ PMH-12V100WCL□ PMH-24V50WCA□, PMH-24V100WCL□, PMH-24V100WCM□ PMT-5V35W1A□, PML-5V35W1A□, PMT-5V50W1A□, PML-5V50W1A□ PMT-15V50W1A□, PML-15V50W1A□ PMT-12V35W1A□, PML-12V35W1A□, PMT-12V50W1A□, PML-12V50W1A□ PMT-24V35W1A□, PML-24V35W1A□, PMT-24V50W1A□, PML-24V50W1A□
	L-02	PMC-12V100W1A□, PMC-12V150W1B□ PMC-24V100W1A□, PMC-24V150W1A□, PMC-24V150W1B□, PMC-24V150W2AA, PMC-DSPV100W1A PMC-48V150W1BA PMH-24V100WCA□, PMH-24V100WCC□, PMH-24V100WCN□, PMH-24V150WCB□, PMH-24V150WCD□, PMH-24V150WCL□ PMU-13V155W□□A, PMU-27V155W□□A PMT-12V100W1A□, PML-12V100W1A□, PMT-12V150W1A□, PML-12V150W1A□ PMT-24V100W1A□, PML-24V100W1A□, PMT-24V150W1A□, PML-24V150W1A□ PMT-48V150W1A□, PML-48V150W1A□ PMT-D1V100W1A□, PML-D1V100W1A□, PMT-D2V100W1A□, PML-D2V100W1A□
	L-03A	PMC-24V300W1BA PMF-24V200WC□□, PMF-24V240WC□□
	P-03	All models *P-03 must be used with L-01, L-02 or L-03A

LM-01

Panel Mount Accessories

■ LM-01

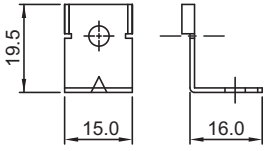

Accessories Assembly

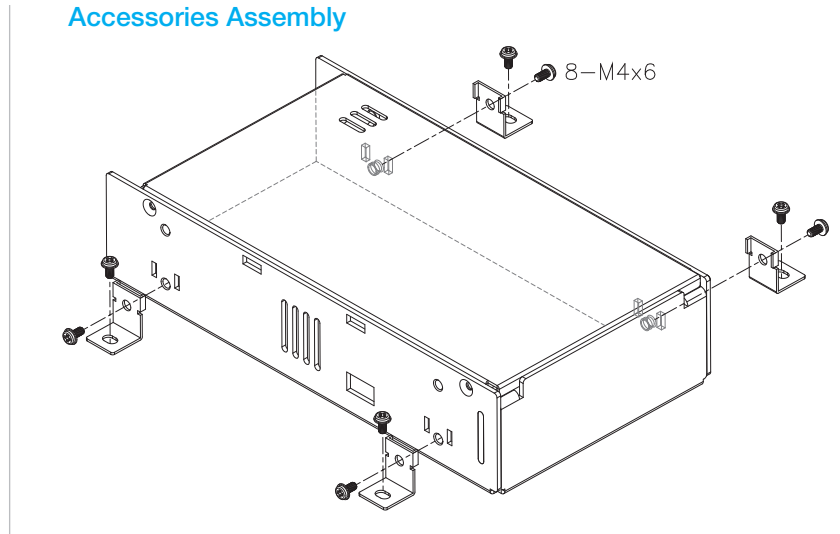

Model Information

Item	Model Number	Compatible Models
	LM-01	PMT-4V350W1A□ PMT-5V350W1A□ PMT-12V350W1A□ PMT-24V200W1A□, PML-24V200W1A□, PMT-24V350W1A□ PMT-36V350W1A□ PMT-48V350W1A□ PMF-4V320WC□□ PMF-5V320WC□□ PMF-24V200WC□□, PMF-24V240WC□□, PMF-24V320WC□□ PMR-4V320WC□A, PMR-4V320WD□A PMR-5V320WC□A, PMR-5V320WD□A

Standards & Approvals

Delta Industrial Power Supplies

	CE	CB Scheme to IEC 60950-1	SIQ or TUV to EN 60950-1	UL 60950-1	UL 508	UL 1310	NEC Class 2	CSA C22.2 No. 107.1-01	CSA C22.2 No. 60950-1	ATEX EN 60079-15	CSA C22.2 No. 213 and ANSI/ISA-12.12.09	EAC (Eurasian Customs Union)	CCC (China)	RoHS Directive 2011/65/EU	SEMI F47	EN 61204-3	EN 61000-3-2 (PFC)	EN 61000-3-3 (Flicker)	EN 61000-6-1 (Immunity)	EN 61000-6-2 (Immunity)	EN 55024 (Immunity)	EN 55011 Class B (Emissions)	EN 55032 Class B (Emissions)
DIN Rail Power Supply																							
DRP012V015W1AY	●	●	●	●	●			●		●	●	●		●			●	●	●	●	●	●	●
DRP012V015W1AZ	●	●	●	●	●			●		●	●	●		●			●	●	●	●	●	●	●
DRP012V030W1AY	●	●	●	●	●			●		●	●	●		●			●	●	●	●	●	●	●
DRP012V030W1AZ	●	●	●	●	●			●		●	●	●		●			●	●	●	●	●	●	●
DRP012V060W1AA	●	●	●	●	●			●		●	●	●		●			●	●	●	●	●	●	●
DRP012V100W1AA	●	●	●	●	●			●		●	●	●		●			●	●	●	●	●	●	●
DRP-24V48W1AZ	●	●	●	●	●			●		●	●	●		●			●	●	●	●	●	●	●
DRP024V060W1AZ	●	●	●	●	●			●	●	●	●	●		●			●	●	●	●	●	●	●
DRP024V060W1AA	●	●	●	●	●			●	●	●	●	●		●	●		●	●	●	●	●	●	●
DRP024V120W1AA	●	●	●	●	●			●	●	●	●	●		●	●		●	●	●	●	●	●	●
DRP024V240W1AA	●	●	●	●	●			●	●	●	●	●		●	●		●	●	●	●	●	●	●
DRP024V480W1AA	●	●	●	●	●			●	●	●	●	●		●	●		●	●	●	●	●	●	●
DRP024V060W1BA	●	●	●	●	●			●		●	●	●		●			●	●	●	●	●	●	●
DRP024V060W1BN	●	●	●	●	●			●		●	●	●		●			●	●	●	●	●	●	●
DRP024V120W1BA	●	●	●	●	●			●		●	●	●	●	●			●	●	●	●	●	●	●
DRP024V120W1BN	●	●	●	●	●			●		●	●	●	●	●			●	●	●	●	●	●	●
DRP024V240W1BA	●	●	●	●	●			●		●	●	●		●			●	●	●	●	●	●	●
DRP024V240W1BN	●	●	●	●	●			●		●	●	●		●			●	●	●	●	●	●	●
DRP024V480W1BA	●	●	●	●	●			●		●	●	●		●			●	●	●	●	●	●	●
DRP024V480W1BN	●	●	●	●	●			●		●	●	●		●			●	●	●	●	●	●	●
DRP024V060W1NY	●	●	●	●	●	●	●	●		●	●	●		●			●	●	●	●	●	●	●
DRP024V060W1NZ	●	●	●	●	●	●	●	●		●	●	●		●			●	●	●	●	●	●	●
DRP-24V100W1NN	●	●	●	●	●	●	●	●		●	●	●		●			●	●	●	●	●	●	●
DRP-24V120W2BN	●	●	●	●	●			●		●	●	●		●			●	●	●	●	●	●	●
DRP-24V240W2BN	●	●	●	●	●			●		●	●	●		●			●	●	●	●	●	●	●
DRP024V060W3BA	●	●	●	●	●			●		●	●	●		●			●	●	●	●	●	●	●
DRP024V060W3BN	●	●	●	●	●			●		●	●	●		●			●	●	●	●	●	●	●
DRP024V120W3BA	●	●	●	●	●			●		●	●	●		●			●	●	●	●	●	●	●
DRP024V120W3BN	●	●	●	●	●			●		●	●	●		●			●	●	●	●	●	●	●
DRP024V240W3BA	●	●	●	●	●			●		●	●	●		●			●	●	●	●	●	●	●
DRP024V240W3BN	●	●	●	●	●			●		●	●	●		●			●	●	●	●	●	●	●
DRP024V480W3BA	●	●	●	●	●			●		●	●	●		●			●	●	●	●	●	●	●
DRP024V480W3BN	●	●	●	●	●			●		●	●	●		●			●	●	●	●	●	●	●
DRP024V960W3BN	●	●	●	●	●			●		●	●	●		●			●	●	●	●	●	●	●
DRP048V060W1BA	●	●	●	●	●			●		●	●	●		●			●	●	●	●	●	●	●
DRP048V060W1BN	●	●	●	●	●			●		●	●	●		●			●	●	●	●	●	●	●
DRP048V120W1BA	●	●	●	●	●			●		●	●	●	●	●			●	●	●	●	●	●	●
DRP048V120W1BN	●	●	●	●	●			●		●	●	●	●	●			●	●	●	●	●	●	●
DRP048V240W1BA	●	●	●	●	●			●		●	●	●		●			●	●	●	●	●	●	●
DRP048V240W1BN	●	●	●	●	●			●		●	●	●		●			●	●	●	●	●	●	●
DRP048V480W1BA	●	●	●	●	●			●		●	●	●		●			●	●	●	●	●	●	●
DRP048V480W1BN	●	●	●	●	●			●		●	●	●		●			●	●	●	●	●	●	●



	CE	CB Scheme to IEC 60950-1	CB Scheme to IEC 61558-1, IEC 61558-2-16, IEC 61010-1	CB Scheme to IEC 60335-1	SIQ or TUV to EN 60950-1	SIQ to EN 61558-1, EN 61558-2-16, EN 61010-1	TUV to EN 60335-1	UL 60950-1	UL 508	NEC Class 2	CSA C22.2 No. 107.1-01	EAC (Eurasian Customs Union)	CCC (China)	DNV GL (Maritime)	ABS	RoHS Directive 2011/65/EU	SEMI F47	EN 61204-3	EN 61000-3-2 (PFC)	EN 61000-3-3 (Flicker)	EN 61000-6-1 (Immunity)	EN 61000-6-2 (Immunity)	EN 55014-2 (Immunity)	EN 55024 (Immunity)	EN 55011 Class B (Emissions)	EN 55014-1 (Emissions)	EN 55032 Class A (Emissions)	EN 55032 Class B (Emissions)	EN 61000-6-3 (Emissions)	EN 61000-6-4 (Emissions)			
DIN Rail Power Supply																																	
DRP-24V120W1C□N	●	●			●			●	●			●				●	△	●	●	●		●		●	●					●			
DRP-24V240W1C□N	●	●			●			●	●			●				●	△	●	●	●		●		●	●					●			
DRP-24V480W1C□N	●	●			●			●	●			●				●	△	●	●	●		●		●	●					●			
DRM-24V80W1PN	●	●	●		●			●	●			●		●	●	●	△	●	●	●		●		●	●					●		●	
DRM-24V120W1PN	●	●	●		●	●		●	●		●	●		●	●	●	△	●	●	●		●		●	●					●		●	
DRM-24V240W1PN	●	●	●		●	●		●	●		●	●		●	●	●	△	●	●	●		●		●	●					●		●	
DRM-24V480W1PN	●	●	●		●	●		●	●		●	●		●	●	●	△	●	●	●		●		●	●					●		●	
DRM-24V960W1PN	●	●	●		●	●		●	●		●	●		●	●	●	△	●	●	●		●		●	●					●		●	
DRV-24V120W1PN	●	●	●		●	●		●	●		●	●		●	●	●	△	●	●	●		●		●	●					●		●	
DRV-24V240W1PN	●	●	●		●	●		●	●		●	●		●	●	●	△	●	●	●		●		●	●					●		●	
DRV-24V480W1PN	●	●	●		●	●		●	●		●	●		●	●	●	△	●	●	●		●		●	●					●		●	
DRL-24V120W1A□	●	●			●			●	●			●	●			●	△	●	●	●	●	●		●	●					●		●	
DRL-24V240W1A□	●	●			●			●	●			●	●			●	△	●	●	●	●	●		●	●					●		●	
DRL-24V480W1A□	●	●			●			●	●			●	●			●	△	●	●	●	●	●		●	●					●		●	
DRL-48V120W1A□	●	●			●			●	●			●	●			●	△	●	●	●	●	●		●	●					●		●	
DRC-5V10W1A□	●	●			●			●	●	●		●				●			●	●	●		●							●		●	
DRC-12V10W1A□	●	●			●			●	●	●		●				●			●	●	●		●							●		●	
DRC-12V30W1A□	●	●			●			●	●	●		●				●			●	●	●		●							●		●	
DRC-12V60W1A□	●	●			●			●	●	●		●				●			●	●	●		●							●		●	
DRC-12V100W1AZ	●	●			●			●	●	●		●				●			●	●	●		●							●		●	
DRC-24V10W1A□	●	●			●			●	●	●		●				●			●	●	●		●							●		●	
DRC-24V10W1HZ	●	●		●	●		●	●	●			●				●			●	●	●	●	●				●				●		●
DRC-24V30W1A□	●	●			●			●	●	●		●				●			●	●	●		●							●		●	
DRC-24V60W1A□	●	●			●			●	●	●		●				●			●	●	●		●							●		●	
DRC-24V100W1A□	●	●			●			●	●	●		●				●			●	●	●		●							●		●	
DRS-5V30W1NZ	●	●			●			●	●	●		●				●		●	●	●	●	●		●	●					●		●	
DRS-5V50W1A□	●	●			●			●	●	●		●				●		●	●	●	●	●		●	●					●		●	
DRS-5V50W1N□	●	●			●			●	●	●		●				●		●	●	●	●	●		●	●					●		●	
DRS-12V50W1N□	●	●			●			●	●	●		●				●		●	●	●	●	●		●	●					●		●	
DRS-24V30W1AZ	●	●			●			●	●	●		●	●			●			●	●	●	●		●	●					●		●	
DRS-24V30W1NZ	●	●			●			●	●	●		●				●		●	●	●	●	●		●	●					●		●	
DRS-24V50W1N□	●	●			●			●	●	●		●				●		●	●	●	●	●		●	●					●		●	
DRS-24V100W1A□	●	●			●			●	●	●		●				●		●	●	●	●	●		●	●					●		●	
DRS-24V100W1N□	●	●			●			●	●	●		●				●		●	●	●	●	●		●	●					●		●	

△ Compliant

Standards & Approvals

Delta Industrial Power Supplies

	CE	CB Scheme to IEC 60950-1	CB Scheme to IEC 62368-1	CB Scheme to IEC 60335-1, IEC 61568-1, IEC 61568-2-16	TUV to EN 60950-1	TUV to EN 62368-1	TUV to EN 60335-1, EN 61568-1, EN 61568-2-16	UL 60950-1	UL 62368-1	CCC (China)	FoHS Directive 2011/65/EU	EN 61000-3-2 (PFC)	EN 61000-3-3 (Flicker)	EN 61000-6-1 (Immunity)	EN 61000-6-2 (Immunity)	EN 55014-2 (Immunity)	EN 55024 (Immunity)	EN 55011 Class B (Emissions)	EN 55032 Class A (Emissions)	EN 55032 Class B (Emissions)	EN 55014-1 (Emissions)	EN 61000-6-3 (Emissions)
Panel Mount Power Supply																						
PMT-4V350W1A□		●					●				●											
PML-5V35W1A□	●	●			●		●			●	●	●	●				●				●	
PMT-5V35W1A□	●	●			●		●			●	●	●	●				●				●	
PML-5V50W1A□	●	●			●		●			●	●	●	●				●				●	
PMT-5V50W1A□	●	●			●		●			●	●	●	●				●				●	
PMT-5V350W1A□		●					●				●											
PMB-12V35W1A□	●	●			●		●			●	●	●	●				●				●	
PML-12V35W1A□	●	●			●		●			●	●	●	●				●				●	
PMT-12V35W1A□	●	●			●		●			●	●	●	●				●				●	
PMB-12V50W1A□	●	●			●		●			●	●	●	●				●				●	
PML-12V50W1A□	●	●			●		●			●	●	●	●				●				●	
PMT-12V50W1A□	●	●			●		●			●	●	●	●				●				●	
PML-12V100W1A□	●	●			●		●			●	●	●	●				●				●	
PMT-12V100W1A□	●	●			●		●			●	●	●	●				●				●	
PML-12V150W1A□	●	●			●		●			●	●	●	●				●				●	
PMT-12V150W1A□	●	●			●		●			●	●	●	●				●				●	
PMT-12V350W1A□	●	●			●		●			●	●	●	●				●				●	
PML-15V50W1A□	●	●			●		●			●	●	●	●				●				●	
PMT-15V50W1A□	●	●			●		●			●	●	●	●				●				●	
PMB-24V35W1A□	●	●			●		●			●	●	●	●				●				●	
PML-24V35W1A□	●	●			●		●			●	●	●	●				●				●	
PMT-24V35W1A□	●	●			●		●			●	●	●	●				●				●	
PMB-24V50W1A□	●	●			●		●			●	●	●	●				●				●	
PML-24V50W1A□	●	●			●		●			●	●	●	●				●				●	
PMT-24V50W1A□	●	●			●		●			●	●	●	●				●				●	
PML-24V100W1A□	●	●			●		●			●	●	●	●				●				●	
PMT-24V100W1A□	●	●			●		●			●	●	●	●				●				●	
PML-24V150W1A□	●	●			●		●			●	●	●	●				●				●	
PMT-24V150W1A□	●	●			●		●			●	●	●	●				●				●	
PML-24V200W1A□		●					●			●	●	●	●									
PMT-24V200W1A□		●					●			●	●	●	●									
PMT-24V350W1AG		●					●			●	●	●	●									
PMT-24V350W1AM		●					●			●	●	●	●									
PMT-24V350W1AK	●	●			●		●			●	●	●	●			●	●	●		●		
PMT-24V350W1AR	●	●			●		●			●	●	●	●			●	●	●		●		
PMT-36V350W1A□	●	●			●		●			●	●	●	●				●				●	
PML-48V150W1A□	●	●			●		●			●	●	●	●				●				●	
PMT-48V150W1A□	●	●			●		●			●	●	●	●				●				●	
PMT-48V350W1A□	●	●			●		●			●	●	●	●				●				●	
PML-D1V100W1A□	●	●			●		●			●	●	●	●				●				●	
PMT-D1V100W1A□	●	●			●		●			●	●	●	●				●				●	
PML-D2V100W1A□	●	●			●		●			●	●	●	●				●				●	
PMT-D2V100W1A□	●	●			●		●			●	●	●	●				●				●	
PMT-12V50W2BA	●	●	●	●		●	●		●	●	●	●	●			●	●	●		●	●	
PMT-12V100W2BA	●	●	●	●		●	●		●	●	●	●	●			●	●	●		●	●	
PMT-12V150W2BA	●	●	●	●		●	●		●	●	●	●	●			●	●	●		●	●	
PMT-24V50W2BA	●	●	●	●		●	●		●	●	●	●	●			●	●	●		●	●	
PMT-24V100W2BA	●	●	●	●		●	●		●	●	●	●	●			●	●	●		●	●	
PMT-24V150W2BA	●	●	●	●		●	●		●	●	●	●	●			●	●	●		●	●	



	CE	CB Scheme to IEC 60950-1	CB Scheme to IEC 62368-1	CB Scheme to IEC 60335-1, IEC 61558-1, IEC 61558-2-16	SIQ or TUV or NEMKO to EN 60950-1	SIQ to EN 62368-1	SIQ to EN 60335-1, EN 61558-1, EN 61558-2-16	UL 60950-1	UL 62368-1	NEC Class 2	EAC (Eurasian Customs Union)	CCC (China)	RoHS Directive 2011/65/EU	EN 61204-3	EN 61000-3-2 (PFC)	EN 61000-3-3 (Flicker)	EN 61000-6-1 (Immunity)	EN 61000-6-2 (Immunity)	EN 55014-2 (Immunity)	EN 55024 (Immunity)	EN 55011 Class B (Emissions)	EN 55032 Class B (Emissions)	EN 55014-1 (Emissions)	EN 61000-6-3 (Emissions)
Panel Mount Power Supply																								
PMC-05V015W1AA	●	●			●			●			●	●	●		●	●					●		●	
PMC-05V035W1A□	●	●			●			●			●	●	●		●	●					●		●	
PMC-05V050W1AA	●	●			●			●			●	●	●		●	●					●		●	
PMC-12V035W1A□	●	●			●			●			●	●	●		●	●					●		●	
PMC-12V050W1A□	●	●			●			●			●	●	●		●	●					●		●	
PMC-12V060W1NA	●	●			●			●		●	●	●	●		●	●					●		●	
PMC-12V100W1A□	●	●			●			●			●	●	●		●	●					●		●	
PMC-12V150W1A□	●	●			●			●			●	●	●		●	●					●		●	
PMC-12V600W1BA	●	●	●		●	●		●	●		●	●	●		●	●					●		●	
PMC-24V035W1A□	●	●			●			●			●	●	●		●	●					●		●	
PMC-24V050W1A□	●	●			●			●			●	●	●		●	●					●		●	
PMC-24V075W1A□	●	●			●			●			●	●	●		●	●					●		●	
PMC-24V100W1A□	●	●			●			●			●	●	●		●	●					●		●	
PMC-24V150W1A□	●	●			●			●			●	●	●		●	●					●		●	
PMC-24V150W2AA	●	●			●			●			●	●	●		●	●					●		●	
PMC-24V150W1B□	●	●			●			●			●	●	●		●	●					●		●	
PMC-24V300W1BA	●	●			●			●			●	●	●		●	●					●		●	
PMC-24V600W1BA	●	●			●			●			●	●	●		●	●		●			●		●	
PMC-DSPV100W1A	●	●			●			●			●	●	●		●	●			●		●		●	
PMC-48V150W1BA	●	●			●			●			●	●	●		●	●					●		●	
PMC-48V600W1BA	●	●	●		●	●		●	●		●	●	●		●	●					●		●	
PMH-24V50WCA□	●	●		●	●		●	●			●	●	●		●	●	●		●		●		●	●
PMH-24V100WCA□	●	●		●	●		●	●			●	●	●		●	●	●		●		●		●	●
PMH-24V100WCC□	●	●		●	●		●	●			●	●	●		●	●	●		●		●		●	●
PMH-24V100WCN□	●	●		●	●		●	●	●		●	●	●		●	●	●		●		●		●	●
PMH-24V150WCB□	●	●		●	●		●	●			●	●	●		●	●	●		●		●		●	●
PMH-24V150WCD□	●	●		●	●		●	●			●	●	●		●	●	●		●		●		●	●
PMH-24V200WCB□	●	●		●	●		●	●			●	●	●		●	●	●		●		●		●	●
PMH-12V100WCL□	●	●		●	●		●	●			●	●	●		●	●	●		●		●		●	●
PMH-24V100WCL□	●	●		●	●		●	●			●	●	●		●	●	●		●		●		●	●
PMH-24V100WCM□	●	●		●	●		●	●	●		●	●	●		●	●	●		●		●		●	●
PMH-24V150WCL□	●	●		●	●		●	●			●	●	●		●	●	●		●		●		●	●
PMF-4V320WC□□	●	●			●			●			●	●	●		●	●					●		●	
PMF-5V320WC□□	●	●			●			●			●	●	●		●	●					●		●	
PMF-24V200WCA□	●	●			●			●			●	●	●		●	●					●		●	
PMF-24V200WCG□	●	●			●			●			●	●	●		●	●					●		●	
PMF-24V240WCA□	●	●			●			●			●	●	●		●	●					●		●	
PMF-24V240WCG□	●	●			●			●			●	●	●		●	●					●		●	
PMF-24V320WCA□	●	●			●			●			●	●	●		●	●					●		●	
PMF-24V320WCG□	●	●			●			●			●	●	●		●	●					●		●	
PMR-4V320WC□A	●	●			●			●			●	●	●		●	●					●		●	
PMR-4V320WD□A	●	●			●			●			●	●	●		●	●					●		●	
PMR-5V320WC□A	●	●			●			●			●	●	●		●	●					●		●	
PMR-5V320WD□A	●	●			●			●			●	●	●		●	●					●		●	

Standards & Approvals

Delta Industrial Power Supplies

	CE	CB Scheme to IEC 60950-1	CB Scheme to IEC 62368-1	SIQ or TUV to EN 60950-1	TUV to EN 62368-1	UL 60950-1	UL 62368-1	BSMI	EAC (Eurasian Customs Union)	CCC (China)	CQC (China)	KC (Korea)	RoHS Directive 2011/65/EU	EN 61000-3-2 (PFC)	EN 61000-3-3 (Flicker)	EN 61000-6-1 (Immunity)	EN 61000-6-2 (Immunity)	EN 55014-2 (Immunity)	EN 55024 (Immunity)	EN 55011 Class B (Emissions)	EN 55032 Class A (Emissions)	EN 55032 Class B (Emissions)	EN 55014-1 (Emissions)	EN 61000-6-3 (Emissions)	FCC Part 15 Class B (Emissions)	
Panel Mount Power Supply																										
PMU-13V155W□□A	●	●		●		●				●			●	●	●				●							
PMU-27V155W□□A	●	●		●		●				●			●	●	●				●							
Open Frame Power Supply																										
PJT-12V40WBA□	●	●		●		●							●	●	●				●							
PJT-12V65WBA□	●	●	●	●		●							●	●	●				●							
PJT-12V100WBA□	●	●		●		●							●	●	●				●							
PJT-12V100WBB□	●	●		●		●							●	●	●				●							
PJT-15V40WBA□	●	●		●		●							●	●	●				●							
PJT-15V65WBA□	●	●	●	●		●							●	●	●				●							
PJT-15V100WBA□	●	●		●		●							●	●	●				●							
PJT-15V100WBB□	●	●		●		●							●	●	●				●							
PJT-18V40WBA□	●	●		●		●							●	●	●				●							
PJT-18V65WBA□	●	●	●	●		●							●	●	●				●							
PJT-18V100WBA□	●	●		●		●							●	●	●				●							
PJT-18V100WBB□	●	●		●		●							●	●	●				●							
PJT-24V40WBA□	●	●		●		●							●	●	●				●							
PJT-24V65WBA□	●	●	●	●		●							●	●	●				●							
PJT-24V100WBA□	●	●		●		●							●	●	●				●							
PJT-24V100WBB□	●	●		●		●							●	●	●				●							
PJT-27V150WBNA	●	●		●		●			●				●	●	●				●							
PJ-12V15W□NA	●	●		●		●							●	●	●				●							
PJ-12V30W□NA	●	●		●		●							●	●	●				●							
PJ-12V50W□NA	●	●		●		●							●	●	●				●							
PJ-12V100W□□A	●	●		●		●							●	●	●				●							
PJ-12V150W□□A	●	●		●		●							●	●	●				●							
PJ-24V30W□NA	●	●		●		●							●	●	●				●							
PJ-24V50W□NA	●	●		●		●							●	●	●				●							
PJ-24V100W□□A	●	●		●		●							●	●	●				●							
PJ-24V150W□□A	●	●		●		●							●	●	●				●							
PJ-5V15W□NA	●	●		●		●							●	●	●				●							
PJ-48V50W□NA	●	●		●		●							●	●	●				●							
PJB-24V100W□□A	●	●		●		●							●	●	●				●							
PJB-24V150W□□A	●	●		●		●							●	●	●				●							
PJB-24V240W□□A	●	●		●		●							●	●	●				●							



	CE	CB Scheme to IEC 60950-1	CB Scheme to IEC 62368-1	CB Scheme to IEC 60335-1, IEC 61588-1, IEC 61588-2-16	SIQ or TUV to EN 60950-1	SIQ to EN 62368-1	SIQ to EN 60335-1, EN 61588-1, EN 61588-2-16	UL 60950-1	UL 62368-1	UL 508	CSA C22.2 No. 107.1-01	ATEX EN 60079-15	CSA C22.2 No. 213 and ANSI/ISA-12.12.09	BSMI	EAC (Eurasian Customs Union)	CCC (China)	CQC (China)	KC (Korea)	RoHS Directive 2011/65/EU	EN 61204-3	EN 61000-3-2 (PFC)	EN 61000-3-3 (Flicker)	EN 61000-6-1 (Immunity)	EN 61000-6-2 (Immunity)	EN 55014-2 (Immunity)	EN 55024 (Immunity)	EN 55011 Class B (Emissions)	EN 55032 Class B (Emissions)	FCC Part 15 Class B (Emissions)					
Open Frame Power Supply																																		
PJH-24V300WBB□	○	○	○	○	○	○	○	○	○										○	○	○	○				○	○	○	○					
PJH-24V300WBC□	○	○	○	○	○	○	○	○	○										○	○	○	○				○	○	○	○					
PJH-36V300WBB□	○	○	○	○	○	○	○	○	○										○	○	○	○				○	○	○	○					
PJH-36V300WBC□	○	○	○	○	○	○	○	○	○										○	○	○	○				○	○	○	○					
PJU-13V60W□A□	●	●	●		●	●		●	●							●			●	●	●	●					●	●	●	●				
PJU-13V60W□B□	●	●	●		●	●		●	●							●			●	●	●	●					●	●	●	●				
PJU-27V60W□A□	●	●	●		●	●		●	●							●			●	●	●	●					●	●	●	●				
PJU-27V60W□B□	●	●	●		●	●		●	●							●			●	●	●	●					●	●	●	●				
DIN Rail Modules																																		
DRR-20A	●	●			●			●		●		●	●		●				●					●	●			●	●	●	●			
DRR-20N	●	●			●			●		●		●	●		●				●					●	●			●	●	●	●			
DRR-40A	●	●			●			●		●		●	●		●				●					●	●			●	●	●	●			
DRR-40N	●	●			●			●		●		●	●		●				●					●	●			●	●	●	●			
DRB-24V020ABA	●	●			●			●		●	●	●	●		●				●	●					●	●			●	●	●	●		
DRB-24V020ABN	●	●			●			●		●	●	●	●		●				●	●	●	●			●	●			●	●	●	●		
DRB-24V040ABN	●	●			●			●		●	●	●	●		●				●	●	●	●			●	●			●	●	●	●		
DRU-24V40ABN	●	●			●			●		●	●	●	●		●				●	●	●	●			●	●			●	●	●	●		
DRU-24V10ACZ	●	●			●			●		●	●	●	●		●				●	●	●	●			●	●			●	●	●	●		

○ Pending

Standards & Approvals

Delta Medical Power Supplies

	CE	CB Scheme to IEC 60601-1	CB Scheme to IEC 60950-1	UL 60601-1	UL 60950-1	CCC (China)	CCC (China)	TUV to EN 60601-1	TUV to EN 60950-1	EN 55011 Class B (Emissions)	EN 55032 Class B (Emissions)
Enclosed Power Supply											
MDS-200ADB12	●	●	●	●	●	●		●	●	●	●
MDS-250ADB12	●	●	●	●	●	●		●	●	●	●
MDS-300ADB12	●	●	●	●	●	●		●	●	●	●
MDS-400ADB12	●	●	●	●	●	●		●	●	●	●
MDS-300ADB18	●	●	●	●	●	●		●	●	●	●
MDS-200ADB24	●	●	●	●	●	●		●	●	●	●
MDS-250ADB24	●	●	●	●	●	●		●	●	●	●
MDS-300ADB24	●	●	●	●	●	●		●	●	●	●
MDS-400ADB24	●	●	●	●	●	●		●	●	●	●
MDS-300ADB48	●	●	●	●	●	●		●	●	●	●
MEB-1K2A24T	●	●	●	●	●	●		●	●	●	●
MEB-1K2A48T	●	●	●	●	●	●		●	●	●	●
Open Frame Power Supply											
MDS-040APS12 B	●	●	●	●	●	●				●	●
MDS-065APS12 B	●	●	●	●	●		●			●	●
MDS-100APS12 B	●	●	●	●	●		●			●	●
MDS-100BPS12 B	●	●	●	●	●		●			●	●
MDS-200APB12	●	●	●	●	●	●		●	●	●	●
MDS-250APB12	●	●	●	●	●	●		●	●	●	●
MDS-300APB12	●	●	●	●	●	●		●	●	●	●
MDS-400APB12	●	●	●	●	●	●		●	●	●	●
MDS-040APS15 B	●	●	●	●	●	●				●	●
MDS-065APS15 B	●	●	●	●	●		●			●	●
MDS-100APS15 B	●	●	●	●	●		●			●	●
MDS-100BPS15 B	●	●	●	●	●		●			●	●
MDS-040APS18 B	●	●	●	●	●	●				●	●
MDS-065APS18 B	●	●	●	●	●		●			●	●
MDS-100APS18 B	●	●	●	●	●		●			●	●
MDS-100BPS18 B	●	●	●	●	●		●			●	●
MDS-300APB18	●	●	●	●	●	●		●	●	●	●
MDS-400AUS19 B	●	●	●	●	●	●				●	●
MDS-400AUS24 B	●	●	●	●	●	●				●	●
MDS-040APS24 B	●	●	●	●	●	●				●	●
MDS-065APS24 B	●	●	●	●	●		●			●	●
MDS-100APS24 B	●	●	●	●	●		●			●	●
MDS-100BPS24 B	●	●	●	●	●		●			●	●
MDS-200APB24	●	●	●	●	●	●		●	●	●	●
MDS-250APB24	●	●	●	●	●	●		●	●	●	●
MDS-300APB24	●	●	●	●	●	●		●	●	●	●
MDS-400APB24	●	●	●	●	●	●		●	●	●	●
MDS-300APB48	●	●	●	●	●	●		●	●	●	●
MDS-100AP401 B	●	●	●	●	●		●			●	●
MEP-25A15J	●	●	●	●	●		●			●	●
MEU-600C24T	●	●	●	●	●	●		●	●	●	●
MEU-600C48T	●	●	●	●	●	●		●	●	●	●



	CE	CB Scheme to IEC 60601-1	CB Scheme to IEC 60950-1	UL 60601-1	UL 60950-1	CSA 60601-1	CCC (China)	CQC (China)	TUV to EN 60601-1	TUV to EN 60950-1	EN 55011 Class B (Emissions)	EN 55032 Class B (Emissions)
ATX Power Supply												
MDS-350AD701	●	●	●	●	●		●					
Configurable Power Supply												
MEG-1K2A4	○	○	○		○	○					○	○
MEG-2K1A6	●	●	●		●	●					●	●
Adapter												
MDS-005AAS05 A	●	●		●			●				●	●
MDS-005AAS05 B	●	●		●							●	●
MDS-005AAS05 C	●	●									●	●
MDS-030AAC05	●	●		●			●				●	●
MDS-005AAS06 A	●	●					●					
MDS-005AAS06 B	●	●		●							●	●
MDS-005AAS06 C	●	●									●	●
MDS-030AAC07	●	●		●			●				●	●
MDS-030AAC12	●	●		●			●				●	●
MDS-060AAS12 B	●	●		●			●				●	●
MDS-060BAS12 A	●	●		●			●				●	●
MDS-080AAS12 A	●	●		●			●				●	●
MDS-150AAS12 B	●	●		●			●				●	●
MDS-030AAC15	●	●		●			●				●	●
MDS-060AAS15 B	●	●		●			●				●	●
MDS-090AAS15 B	●	●		●			●				●	●
MDS-060AAS19 B	●	●		●			●				●	●
MDS-060BAS19 A	●	●		●			●				●	●
MDS-090AAS19 B	●	●		●			●				●	●
MDS-150AAS19 B	●	●		●			●				●	●
MDS-150CAB19	●	●		●			●				●	●
MDS-030AAC24	●	●		●			●				●	●
MDS-060AAS24 B	●	●		●			●				●	●
MDS-060BAS24 A	●	●		●			●				●	●
MDS-090AAS24 B	●	●		●			●				●	●
MDS-090BAS24 A	●	●		●			●				●	●
MDS-150AAS24 B	●	●		●			●				●	●
MEA-120A15B	●	●	●	●	●		●				●	●
MEA-250A24C	●	●	●	●			●					
MEF-010A05B	●	●	●	●	●						●	●

○ Pending

Standards & Approvals

Delta LED Power Supplies

LED Driver	CE	CB Scheme to IEC 60950-1	CB Scheme to IEC 61347-1, IEC 61347-2-13	SIQ or TUV to EN 60950-1	ENEC to EN 61347-1, EN 61347-2-13, EN 62384	Compliance to UL 60950-1	UL 8750	UL 60950-1 and CSA C22.2 No. 60950-1	CCC (China) to GB19519.1, GB19510.1,4	KC (Korea) to KC61347-1, KC61347-2-13, KC62384	PSE (Japan) to J61347-1, J61347-2-13	RoHS Directive 2011/65/EU	EN 61000-3-2 (PFC), Class C	EN 61000-3-3 (Flicker)	EN 61547 (Immunity)	EN 55024 (Immunity)	EN 55015 (Emissions)	EN 55032 Class B (Emissions)	FCC Title 47 Class B (Emissions)	
LNE-12V100WAAA							●	●				●	△	△	△	△	△	△	△	△
LNE-12V100WDAA							●	●				●	△	△	△	△	△	△	△	△
LNE-12V120WAAA							●	●				●	△	△	△	△	△	△	△	△
LNE-12V120WDAA							●	●				●	△	△	△	△	△	△	△	△
LNE-12V150WAAA							●	●				●	△	△	△	△	△	△	△	△
LNE-12V150WDAA							●	●				●	△	△	△	△	△	△	△	△
LNE-12V185WAAA							●	●				●	△	△	△	△	△	△	△	△
LNE-12V185WDAA							●	●				●	△	△	△	△	△	△	△	△
LNE-12V320WAAA							●	●				●	△	△	△	△	△	△	△	△
LNE-12V320WBAA							●	●				●	△	△	△	△	△	△	△	△
LNE-12V320WDAA							●	●				●	△	△	△	△	△	△	△	△
LNE-12V100WACA	●		●		●				●	●	●	●	●	●	●	●	△	●	△	△
LNE-12V100WDCA	●		●		●				●	●	●	●	●	●	●	△	●	△	△	△
LNE-12V120WACA	●		●		●				●	●	●	●	●	●	●	△	●	△	△	△
LNE-12V120WDCA	●		●		●				●	●	●	●	●	●	●	△	●	△	△	△
LNE-12V150WACA	●		●		●				●	●	●	●	●	●	●	△	●	△	△	△
LNE-12V150WDCA	●		●		●				●	●	●	●	●	●	●	△	●	△	△	△
LNE-12V185WACA	●		●		●				●	●	●	●	●	●	●	△	●	△	△	△
LNE-12V185WDCA	●		●		●				●	●	●	●	●	●	●	△	●	△	△	△
LNE-12V320WACA	●		●		●				●	●	●	●	●	●	●	△	●	△	△	△
LNE-12V320WBCA	●		●		●				●	●	●	●	●	●	●	△	●	△	△	△
LNE-12V320WDCA	●		●		●				●	●	●	●	●	●	●	△	●	△	△	△
LNE-24V100WAAA							●	●				●	△	△	△	△	△	△	△	△
LNE-24V100WDAA							●	●				●	△	△	△	△	△	△	△	△
LNE-24V120WAAA							●	●				●	△	△	△	△	△	△	△	△
LNE-24V120WDAA							●	●				●	△	△	△	△	△	△	△	△
LNE-24V150WAAA							●	●				●	△	△	△	△	△	△	△	△
LNE-24V150WDAA							●	●				●	△	△	△	△	△	△	△	△
LNE-24V185WAAA							●	●				●	△	△	△	△	△	△	△	△
LNE-24V185WDAA							●	●				●	△	△	△	△	△	△	△	△
LNE-24V320WAAA							●	●				●	△	△	△	△	△	△	△	△
LNE-24V320WBAA							●	●				●	△	△	△	△	△	△	△	△
LNE-24V320WDAA							●	●				●	△	△	△	△	△	△	△	△
LNE-24V100WACA	●		●		●				●	●	●	●	●	●	●	△	●	△	△	△
LNE-24V100WDCA	●		●		●				●	●	●	●	●	●	●	△	●	△	△	△
LNE-24V120WACA	●		●		●				●	●	●	●	●	●	●	△	●	△	△	△
LNE-24V120WDCA	●		●		●				●	●	●	●	●	●	●	△	●	△	△	△
LNE-24V150WACA	●		●		●				●	●	●	●	●	●	●	△	●	△	△	△
LNE-24V150WDCA	●		●		●				●	●	●	●	●	●	●	△	●	△	△	△
LNE-24V185WACA	●		●		●				●	●	●	●	●	●	●	△	●	△	△	△
LNE-24V185WDCA	●		●		●				●	●	●	●	●	●	●	△	●	△	△	△
LNE-24V320WACA	●		●		●				●	●	●	●	●	●	●	△	●	△	△	△
LNE-24V320WBCA	●		●		●				●	●	●	●	●	●	●	△	●	△	△	△
LNE-24V320WDCA	●		●		●				●	●	●	●	●	●	●	△	●	△	△	△
LNE-36V100WAAA							●	●				●	△	△	△	△	△	△	△	△
LNE-36V100WDAA							●	●				●	△	△	△	△	△	△	△	△
LNE-36V120WAAA							●	●				●	△	△	△	△	△	△	△	△
LNE-36V120WDAA							●	●				●	△	△	△	△	△	△	△	△
LNE-36V150WAAA							●	●				●	△	△	△	△	△	△	△	△
LNE-36V150WDAA							●	●				●	△	△	△	△	△	△	△	△

△ Compliant

	CE	CB Scheme to IEC 60950-1	CB Scheme to IEC 61347-1, IEC 61347-2-13	SIQ or TUV to EN 60950-1	ENEC to EN 61347-1, EN 61347-2-13, EN 62384	Compliance to UL 60950-1	UL 8750	UL 60950-1 and CSA C22.2 No. 60950-1	CCC (China) to GB19519.1, GB19510.14	KC (Korea) to KC61347-1, KC61347-2-13, KC62384	PSE (Japan) to J61347-1, J61347-2-13	RoHS Directive 2011/65/EU	EN 61000-3-2 (PFC), Class C	EN 61000-3-3 (Flicker)	EN 61000-6-2 (Immunity)	EN 61547 (Immunity)	EN 55024 (Immunity)	EN 55015 (Emissions)	EN 55032 Class B (Emissions)	FCC Title 47 Class B (Emissions)
LED Driver																				
LNE-36V185WAAA							●	●				●	△	△		△	△	△	△	△
LNE-36V185WDAA							●	●				●	△	△		△	△	△	△	△
LNE-36V320WAAA							●	●				●	△	△		△	△	△	△	△
LNE-36V320WBAA							●	●				●	△	△		△	△	△	△	△
LNE-36V320WDAA							●	●				●	△	△		△	△	△	△	△
LNE-36V100WACA	●		●		●				●	●	●	●	●	●		●	△	●	△	△
LNE-36V100WDCA	●		●		●				●	●	●	●	●	●		●	△	●	△	△
LNE-36V120WACA	●		●		●				●	●	●	●	●	●		●	△	●	△	△
LNE-36V120WDCA	●		●		●				●	●	●	●	●	●		●	△	●	△	△
LNE-36V150WACA	●		●		●				●	●	●	●	●	●		●	△	●	△	△
LNE-36V150WDCA	●		●		●				●	●	●	●	●	●		●	△	●	△	△
LNE-36V185WACA	●		●		●				●	●	●	●	●	●		●	△	●	△	△
LNE-36V185WDCA	●		●		●				●	●	●	●	●	●		●	△	●	△	△
LNE-36V320WACA	●		●		●				●	●	●	●	●	●		●	△	●	△	△
LNE-36V320WBCA	●		●		●				●	●	●	●	●	●		●	△	●	△	△
LNE-36V320WDCA	●		●		●				●	●	●	●	●	●		●	△	●	△	△
LNE-48V100WAAA							●	●				●	△	△		△	△	△	△	△
LNE-48V100WDAA							●	●				●	△	△		△	△	△	△	△
LNE-48V120WAAA							●	●				●	△	△		△	△	△	△	△
LNE-48V120WDAA							●	●				●	△	△		△	△	△	△	△
LNE-48V150WAAA							●	●				●	△	△		△	△	△	△	△
LNE-48V150WDAA							●	●				●	△	△		△	△	△	△	△
LNE-48V185WAAA							●	●				●	△	△		△	△	△	△	△
LNE-48V185WDAA							●	●				●	△	△		△	△	△	△	△
LNE-48V320WAAA							●	●				●	△	△		△	△	△	△	△
LNE-48V320WBAA							●	●				●	△	△		△	△	△	△	△
LNE-48V320WDAA							●	●				●	△	△		△	△	△	△	△
LNE-48V100WACA	●		●		●				●	●	●	●	●	●		●	△	●	△	△
LNE-48V100WDCA	●		●		●				●	●	●	●	●	●		●	△	●	△	△
LNE-48V120WACA	●		●		●				●	●	●	●	●	●		●	△	●	△	△
LNE-48V120WDCA	●		●		●				●	●	●	●	●	●		●	△	●	△	△
LNE-48V150WACA	●		●		●				●	●	●	●	●	●		●	△	●	△	△
LNE-48V150WDCA	●		●		●				●	●	●	●	●	●		●	△	●	△	△
LNE-48V185WACA	●		●		●				●	●	●	●	●	●		●	△	●	△	△
LNE-48V185WDCA	●		●		●				●	●	●	●	●	●		●	△	●	△	△
LNE-48V320WACA	●		●		●				●	●	●	●	●	●		●	△	●	△	△
LNE-48V320WBCA	●		●		●				●	●	●	●	●	●		●	△	●	△	△
LNE-48V320WDCA	●		●		●				●	●	●	●	●	●		●	△	●	△	△
LNE-54V150WAAA							●	●				●	△	△		△	△	△	△	△
LNE-54V150WDAA							●	●				●	△	△		△	△	△	△	△
LNE-54V185WAAA							●	●				●	△	△		△	△	△	△	△
LNE-54V185WDAA							●	●				●	△	△		△	△	△	△	△
LNE-54V150WACA	●		●		●				●	●	●	●	●	●		●	△	●	△	△
LNE-54V150WDCA	●		●		●				●	●	●	●	●	●		●	△	●	△	△
LNE-54V185WACA	●		●		●				●	●	●	●	●	●		●	△	●	△	△
LNE-54V185WDCA	●		●		●				●	●	●	●	●	●		●	△	●	△	△
Open Frame Power Supply																				
PJL-48V200WBAA	●	●	●				●	●				●			●		●		●	
PJL-48V400WBAA	●	●	●				●	●				●			●		●		●	

△ Compliant



? What is Power Boost?

It is the reserve power available constantly that allows reliable startup of loads with high outrush current.

? Why is Power Boost beneficial?

Such feature is especially useful for applications where loads are active; the high surge current can cause the power supply unit (PSU) output to dip down if the PSU does not have the capability to withstand this surge current. Consequently, this could reset the system and result in system downtime.

? What is Advanced Power Boost (APB)?

Within a multiple loads connection, Advanced Power Boost (APB) can detect a faulty current path and provide a large outrush current to trip the circuit breaker connected to the faulty path. This prevents the system from shutting down while the other connected current paths continue to operate without interruption.

? What should I consider when selecting a power supply unit (PSU)?

- Input Type (Single Phase or 3 Phase)
- Output Power
- Efficiency and Reliability

Efficiency and Reliability are the two most important factors to consider in selecting a PSU.

The best way to ensure the reliability of the PSU is to choose one that provides a maximum of 30% more output than your actual total requirement. For example, if your system has a 90W power requirement, you should choose a PSU with at least 120W power output rating. By doing so, you are boosting the reliability of the PSU as well as prolonging the entire system life.

An efficient PSU will thus ensure that power loss is minimized and will greatly help to lower your operating costs in the long run. By choosing a cheaper, but less efficient PSU will just mean that you are paying for it through your monthly electric bills. Delta's CiiQ DIN rail power supply easily give our users a substantial efficiency of up to 87% or more even when operating at <100% load. Other factors to consider include the operating conditions, types of safety certifications, PSU protection and application functions. Please contact your nearest Delta sales representative for a recommendation based on your requirements.

? What critical parameters do I have to watch out for when connecting the power supplies in series?

The turn ON would be non-monotonic as the power supply with the fastest startup time and rise time will turn on first. As a result, the startup waveform with 2 power supplies connected in series would see a step.

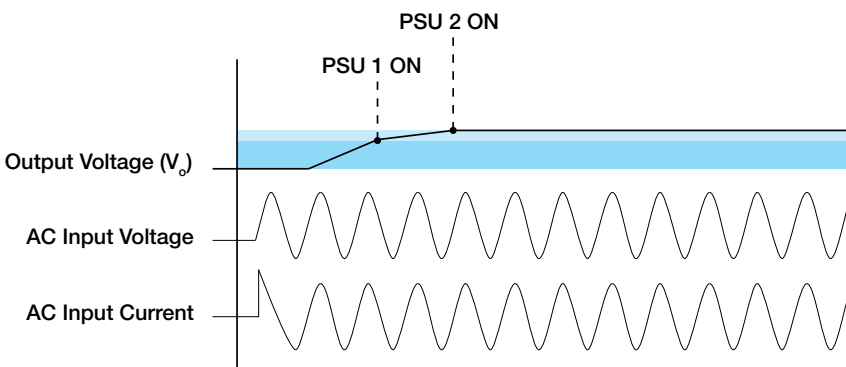

Warranty

Delta warrants that the products (“Products”) sold in this catalog will be free of defects in material and workmanship within the warranty period. The warranty does not apply to Products which have been subjected to abuse, misuse, accident, neglect, unauthorized and/or improper installation, operation, use, maintenance, repair or alteration, or accident of unusual deterioration or degradation of the Products or parts thereof due to physical environment beyond the requirements of the Product specifications.

Attention

Delta provides all information in the catalog and datasheets on an “AS IS” basis and does not offer any kind of warranty through the information for using the product. In the event of any discrepancy between the information in the catalog and datasheets, the datasheets shall prevail (please refer to www.DeltaPSU.com for the latest datasheets information). Delta shall have no liability of indemnification for any claim or action arising from any error for the provided information in the catalog and datasheets. Customer shall take its responsibility for evaluation of using the product before placing an order with Delta.

Delta reserves the right to make changes to the information described in the catalog and datasheets without notice.

EMC Directives

At Delta, all of our products are designed to meet the highest quality standards. All national and international safety certifications including EMC directives are conducted by qualified and independent laboratories. For EMC directives’ compliance, the power supplies are tested to ensure compliance as a stand-alone product. Power supplies like the panel mount and open frame types are typically considered component power supply. Therefore, Delta cannot guarantee the system which is installed with Delta’s component power supply can meet the related EMC directives. Customers are advised to contact the system manufacturer for confirmation.

Availability

Products with “New” tab are slated for official release with immediate effect, while products with “Coming Soon” tab will be available within the next two months from this catalog’s publication month (Refer to cover page). Kindly contact your local Delta distributor for availability, ordering and delivery details. You may also get in touch with us via the Feedback Form on www.DeltaPSU.com/feedback.

Augmented Reality (AR) Power Supply Catalog

Delta Standard Power Supplies

Our innovations in a new perspective

Download **DeltaPSU AR** app to explore the products in 3D details (pages 16-17, 33-34, 54-55, 66, 76, 80, 92, 94, 108 and 120).



4 easy steps

- 1 Download **DeltaPSU AR** app from the App Store or Google Play.



- 2 Open the app and select the "Scan AR" menu.
- 3 Scan product image with the  logo on the page to view the 3D product simulation.
- 4 Follow the instructions on the top right tab and users will be able to zoom in/out or rotate the product's 3D image for greater details.

*Software and Hardware Requirements

- iOS devices: Requires iOS 10.0 or above. Compatible with iPhone 5 or above; iPad 2 or above.
- Android devices: Requires Android 5.0 or above. Requires 1 GB RAM or above.

More Information

Delta Standard Power Supplies

For more information, find us at:



Our responsive homepage adapts to desktop PC and mobile devices effortlessly.

Simply visit www.DeltaPSU.com for all your product needs.

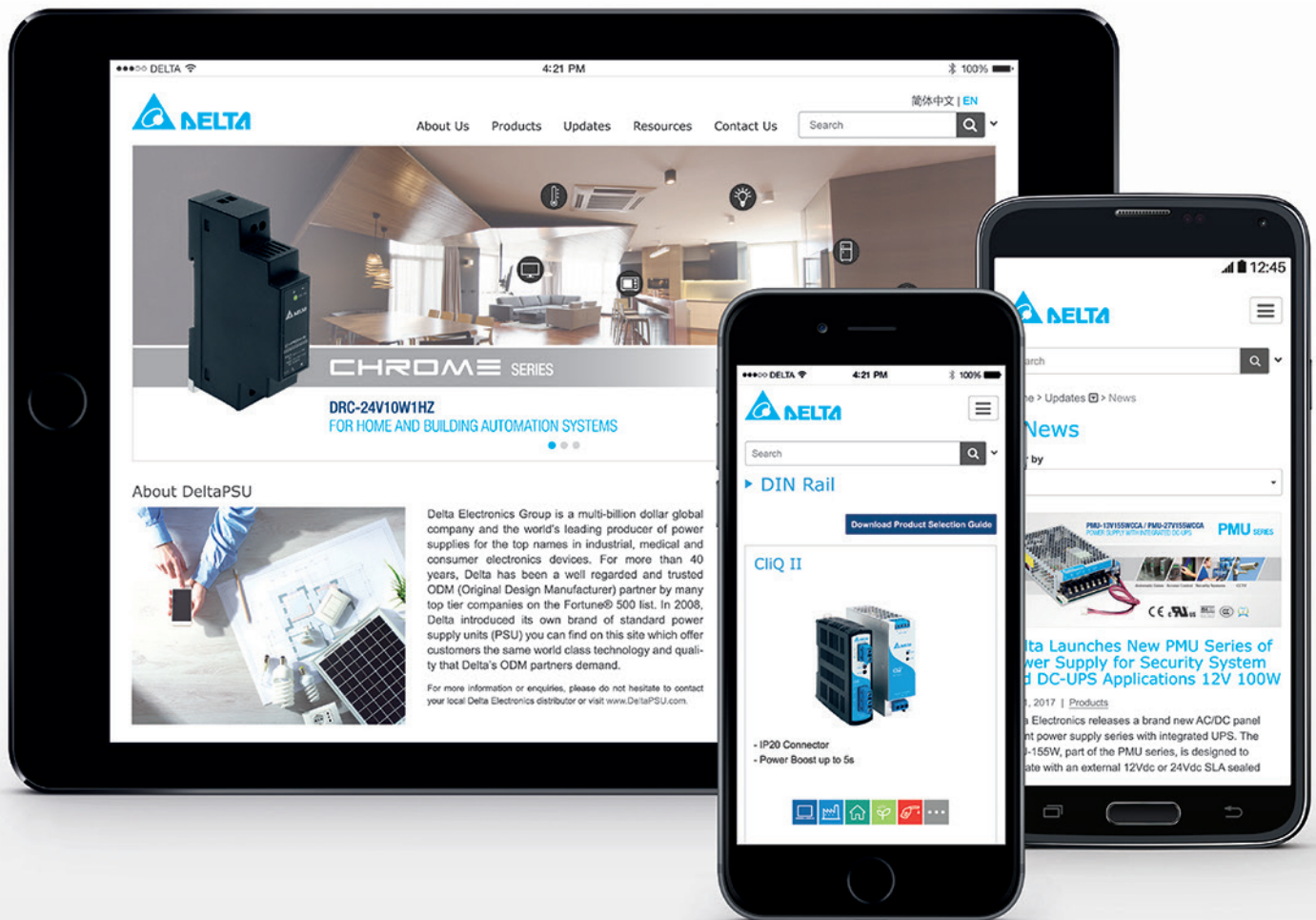

Subscribe to DeltaPSU newsletter and be the first to know the latest product news and industry knowledge.



ASIA

Delta Electronics, Inc.

3 Tungyuan Road, Chungli Industrial Zone,
Taoyuan County 32063, Taiwan, R.O.C

Tel: +886 3 452 6107
Fax: +886 3 434 3617

Delta Electronics (Shanghai) Co., Ltd. Headquarters

No. 182 Minyu Road, Pudong,
Shanghai, P.R.C. 201209

Tel: +86 21 68723988
Fax: +86 21 68723996

Delta Electronics (Shanghai) Co., Ltd. Beijing Branch

No. 7 Building, 6th Courtyard, Beichen East Rd.,
Chaoyang Dist., Beijing, P.R.C. 100105

Tel: +86 10 82253225
Fax: +86 10 82251360

Delta Electronics (Thailand) PCL.

909 Soi 9, Moo 4, Bangpoo Industrial Estate
(E.P.Z.), Pattana 1 Rd., T. Phrakasa, A. Muang,
Samutprakarn 10280, Thailand

Tel: +662 709 2800
Fax: +662 709 2827

Delta India Electronics Pvt. Ltd.

Plot No. 43, Sector - 35, HSIIDC,
Gurgaon, Haryana 122001

Tel: +91 124 4874900
+91 124 4169040
Fax: +91 124 4874945

Delta Electronics (Japan), Inc.

2-1-14 Minato-ku Shibadaimon,
Tokyo, 105-0012, Japan

Tel: +81 3 5733 1155
Fax: +81 3 5733 1255

Delta Electronics (Korea), Inc.

1504, 219, Gasan Digital 1-Ro., Geumcheon-gu,
Seoul, 08501 South Korea

Tel: +82-2-515-5305
Fax: +82-2-515-5302

NORTH AMERICA

Delta Products Corporation North American Headquarters

46101 Fremont Blvd.
Fremont, CA 94538, U.S.A.
Tel: +1 510 668 5100

CENTRAL AND SOUTH AMERICA

Delta Greentech (Brasil) S.A.

Rua Itapeva, 26 - 3º, andar Edifício Itapeva,
One - Bela Vista 01332-000 - São Paulo - SP -
Brasil

Tel: +55 11 3568 3850
Fax: +55 11 3568 3865

Delta Electronics International Mexico, S.A. de C.V.

Centrum Park, Av. Gustavo Baz Prada 309
Edificio E Planta Baja, Col. La Loma, C.P.
54030 Tlalnepantla, Estado de México

Tel: +52 1 55 3603 9200

EUROPE

Delta Electronics (Netherlands) B.V. EMEA Headquarters

Zandsteen 15
2132 MZ Hoofddorp, The Netherlands
Tel: +31 20 800 3900
Fax: +31 20 800 3999

De Witbogt 20, 5652 AG Eindhoven,
The Netherlands

Tel: +31 40 800 3800
Fax: +31 40 800 3898

Authorized Distributor:

www.DeltaPSU.com | info@deltapsu.com

October 2018 (Rev. 04) - All information and specifications are subjected to change without prior notice.