

BMD-340

Stand-alone Bluetooth 5 low energy and IEEE 802.15.4 module

Data sheet



Abstract

This technical data sheet describes the BMD-340 stand-alone Bluetooth® low energy and IEEE 802.15.4 module. The OEMs can embed their own application on top of the integrated Bluetooth low energy stack using Nordic Semiconductor SDK integrated development environment (IDE).

Document information

Title	BMD-340	
Subtitle	Stand-alone Bluetooth 5 low energy and IEEE 802.15.4 module	
Document type	Data sheet	
Document number	UBX-19033353	
Revision and date	R11	20-May-2020
Disclosure restriction		

Product status	Corresponding content status	
Functional sample	Draft	For functional testing. Revised and supplementary data will be published later.
In development / Prototype	Objective specification	Target values. Revised and supplementary data will be published later.
Engineering sample	Advance information	Data based on early testing. Revised and supplementary data will be published later.
Initial production	Early production information	Data from product verification. Revised and supplementary data may be published later.
Mass production / End of life	Production information	Document contains the final product specification.

This document applies to the following products:

Product name	Type number	Firmware version	PCN reference	Product status
BMD-340	BMD-340-A-R-00	N/A	UBX-19039722	Mass production
BMD-340	BMD-340-A-R-01	N/A	UBX-19039722	Mass production
BMD-340	BMD-340-A-R-10	N/A	UBX-20009068	Mass production

u-blox or third parties may hold intellectual property rights in the products, names, logos and designs included in this document. Copying, reproduction, modification or disclosure to third parties of this document or any part thereof is only permitted with the express written permission of u-blox.

The information contained herein is provided "as is" and u-blox assumes no liability for its use. No warranty, either express or implied, is given, including but not limited to, with respect to the accuracy, correctness, reliability and fitness for a particular purpose of the information. This document may be revised by u-blox at any time without notice. For the most recent documents, visit www.u-blox.com.

Copyright © u-blox AG.

Contents

Document information	2
Contents	3
1 Functional description	5
1.1 Features	5
1.2 Applications	6
1.3 Block diagram	6
1.4 Product specifications	7
2 Pin definition	9
2.1 Pin assignment.....	9
2.2 Peripheral pins	11
2.3 BMD-300 series footprint compatibility and migration.....	12
2.3.1 BMD-300/301/330/360 to BMD-340 pad differences	13
2.3.2 BMD-300/301/330 to BMD-340 design migration	13
2.4 BMD-340 fan-out example.....	14
3 Electrical specifications	15
3.1 Absolute maximum ratings	15
3.2 Operating conditions	15
3.3 Power and DCDC configuration.....	16
3.3.1 USB power	16
3.3.2 Normal (LV) power mode examples	17
3.3.3 High voltage (HV) power mode examples	18
3.4 General purpose I/O	19
3.5 Module reset	19
3.6 Debug and programming.....	19
3.7 Clocks	20
3.7.1 32.768 kHz crystal (LFXO).....	20
3.7.2 32.768 kHz clock source comparison.....	20
4 Firmware	21
4.1 Factory image	21
4.2 SoftDevices	21
4.2.1 S140	21
4.2.2 S340	21
4.2.3 IEEE 802.15.4 (Thread and Zigbee)	22
4.3 Bluetooth device address	22
5 Mechanical specifications	23
5.1 Dimensions.....	23
5.2 Recommended PCB land pads	23
5.3 Module marking.....	24
5.3.1 Module marking for type number BMD-340-A-R-00.....	24
5.3.2 Module marking for type number BMD-340-A-R-01	24

5.3.3	Module marking for type number BMD-340-A-R-10	25
6	RF Design notes	26
6.1	Recommended RF layout and ground plane	26
6.2	Mechanical enclosure	26
6.3	Antenna patterns	27
6.3.1	X-Y plane	27
6.3.2	X-Z plane	28
6.3.3	Y-Z plane	28
7	BMD-340 evaluation development kit	29
8	Qualification and approvals	30
8.1	United States (FCC)	30
8.1.1	Labeling and user information requirements	30
8.1.2	RF exposure	30
8.2	Canada (ISED)	31
8.2.1	Labeling and user information requirements	31
8.2.2	RF exposure	31
8.3	European Union regulatory compliance	32
8.3.1	Radio Equipment Directive (RED) 2014/53/EU	32
8.4	Australia / New Zealand (RCM)	32
8.5	Japan (MIC)	32
8.6	Bluetooth qualification	33
9	Environmental	34
9.1	RoHS	34
9.2	REACH	34
9.3	California proposition 65 (P65)	34
10	Product handling	35
10.1	Packaging	35
10.1.1	Reel packaging for type number BMD-340-A-R-00 and BMD-340-A-R-01	35
10.1.2	Reel packaging for type number BMD-340-A-R-10	35
10.1.3	Carrier tape dimensions for type number BMD-340-A-R-00 and BMD-340-A-R-01	36
10.1.4	Carrier tape dimensions for type number BMD-340-A-R-10	36
10.2	Moisture sensitivity level	37
10.3	Reflow soldering	37
10.4	ESD precautions	37
11	Ordering information	38
12	Life support and other high-risk use warning	39
	Related Documents	40
	Revision history	40
	Contact	41

1 Functional description

The BMD-340 is an advanced, highly flexible, ultra-low power multiprotocol System on Module (SoM) that enables Bluetooth 5 low energy and IEEE 802.15.4 (Thread and Zigbee) connectivity for portable, and extremely low power embedded systems. With an Arm® Cortex®-M4 with FPU processor, integrated 2.4G Hz transceiver, and an integrated antenna, the BMD-340 provides a complete RF solution allowing faster time to market with reduced development costs. Providing full use of the Nordic Semiconductor nRF52840's capabilities and peripherals, the BMD-340 can power the most demanding applications, all while simplifying designs and reducing BOM costs. The BMD-340 is an ideal solution for designs that require Bluetooth 5 features or 802.15.4 based networking for Thread and Zigbee. Increased integration with built in USB and 5.5 V compatible DC/DC supply reduces design complexity and BOM cost, while expanding possible applications. BMD-340 designs are footprint compatible with the BMD-300/301/330/360, providing low-cost flexibility for tiered product lineups.

1.1 Features

- Based on the Nordic Semiconductor nRF52840 SoC
- Bluetooth 5 PHYs: LE 1M, LE 2M, and LE Coded (long range)
- Bluetooth 5 features: Advertising Extensions, Channel Selection Algorithm #2
- Bluetooth mesh
- IEEE 802.15.4 with Thread and Zigbee support
- Complete RF solution with an integrated PCB antenna
- Integrated DC-DC converter
- No external components required
- Arm® Cortex®-M4 with FPU 32-bit processor
- Arm® TrustZone® Cryptocell 310 security
- True random number generator
- Serial Wire Debug (SWD)
- Nordic Semiconductor SoftDevice ready
- 1 MB embedded flash memory
- 256 KB RAM
- 48 General Purpose I/O Pins
- 12-bit/200 KSPS ADC
- One Full-Speed USB (12 Mbps)
- Four SPI Master/Slave (8 Mbps)
- Quad SPI with Execute in Place (XIP)
- PWM 4 blocks x 4-channels each
- General Purpose and Low power comparators
- Temperature sensor
- Two 2-wire Master/Slave (I2C compatible)
- I2S audio interface
- Two UARTs (w/ CTS/RTS and DMA)
- 20-channel CPU independent Programmable Peripheral Interconnect (PPI)
- Quadrature Demodulator (QDEC)
- 5 x 32 bit timer/counters
- 3 x 24 bit Real Timer Counters (RTC)
- NFC-A tag interface for OOB pairing
- Dimensions: 15.0 x 10.2 x 1.9 mm

1.2 Applications

- Climate control
- Lighting products
- Safety and security
- Home appliances
- Access control
- Internet of Things
- Home Health Care
- Advanced Remote Controls
- Smart Energy Management
- Low-Power Sensor Networks
- Interactive Entertainment Devices
- Environmental Monitoring
- Hotel Automation
- Office Automation

1.3 Block diagram

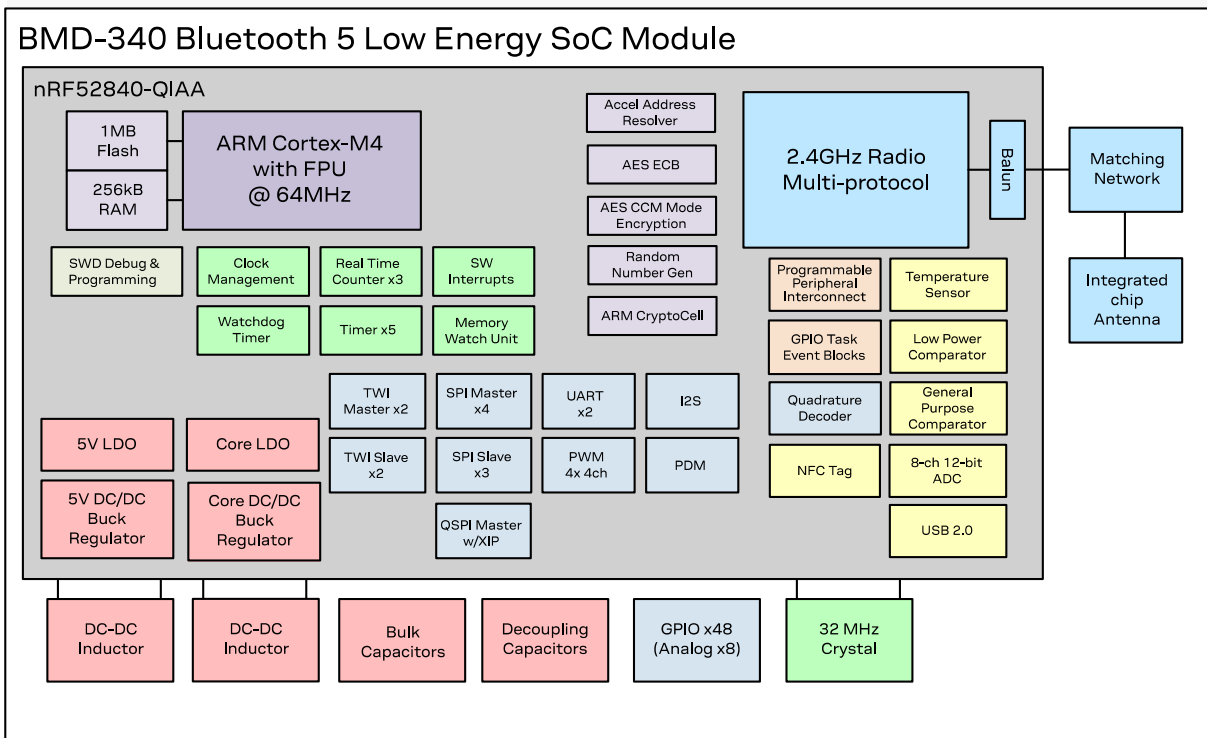

Figure 1: Block diagram of BMD-340

1.4 Product specifications

Detail	Description
Bluetooth	
Bluetooth version	Bluetooth 5 Low Energy, Concurrent Central & Peripheral (S140), LE Coded PHY (Long Range), LE 2M PHY, LE 1M PHY, Advertising Extensions, CSA #2, Bluetooth mesh
Security	AES-128, Arm® Cryptocell accelerated
LE connections	Concurrent central, observer, peripheral, and broadcaster roles with up to twenty concurrent connections along with one Observer and one Broadcaster (S140)
IEEE 802.15.4	
Thread stack	OpenThread, Thread 1.1
Thread security	AES-128, Arm® Cryptocell accelerated
Zigbee stack	Zigbee Compliant Platform
Radio	
Frequency	2.360 GHz to 2.500 GHz
Modulations	GFSK at 1 Mbps and 2 Mbps, QPSK at 250 Kbps
Transmit power	+8 dBm maximum
Receiver sensitivity	-96 dBm (Bluetooth low energy mode)
Antenna	Integrated PCB (-1dBi max gain)
Current consumption	
TX only @ +8 dBm, 0 dBm @ 3V, DCDC enabled	14.8 mA, 4.8 mA
TX only @ +8 dBm, 0 dBm	32.7 mA, 10.6 mA
RX only @ 1 Mbps @ 3V, DCDC enabled	4.6 mA
RX only @ 1 Mbps	9.9 mA
CPU @ 64 MHz from flash, from RAM	6.3 mA, 5.2 mA
CPU @ 64 MHz from flash, from RAM @ 3V, DCDC enabled	3.3 mA, 2.8 mA
System Off, On (Supply on VCC), no RAM retention	0.4 µA, 0.97 µA
System Off, On (Supply on VCC), full 256 KB RAM retention	1.86 µA, 2.35 µA
Dimensions	
BMD-340	Length: 15.0 mm ± 0.3 mm
	Width: 10.2 mm ± 0.3 mm
	Height: 1.9 mm ± 0.1 mm
Hardware	
Interfaces	SPI Master/Slave x 4 Quad SPI x 1 UART x 2 Two-Wire Master/Slave (I2C) x 2 GPIO x 48 I2S x1 PWM x 16 (4 blocks x 4-channels each) PDM x 1 USB 2.0 x 1 Analog input x 8
Power supply	VCC: 1.7 V to 3.6 V, 1.75 V required to start DCDC VCCH: 2.5 V to 5.5 V VBUS: 4.35 V to 5.5 V (For USB operation)
Temperature range	-40 °C to +85 °C

Detail	Description
Certifications	
USA (FCC)	FCC part 15.247 modular certification FCC ID: 2AA9B10
Canada (ISED)	Innovation, Science and Economic Development Canada RSS-247 modular certification IC: 12208A-10
Europe (CE)	EN 60950-1: A2:2013 3.1 (a): Health and Safety of the User EN 301 489-1 V2.1.1 & 3.1 (b): Electromagnetic Compatibility EN 301 489-17 V3.1.1 EN 300 328 V2.1.1 3.2: Effective use of spectrum allocated
Australia / New Zealand (RCM)	AS/NZS 4268:2017, Radio equipment and systems – Short range devices
Japan (MIC)	Ministry of Internal Affairs and Communications (MIC) of Japan pursuant to the Radio Act of Japan – MIC: 204-B00161
Bluetooth	BMD-340 RF-PHY Component (Tested) – DID: D040773; QDID: 95452
Radio chip	
Nordic semiconductor nRF52840	Additional details: nRF52840 Product Specification Software Development Kit

Table 1: Product specifications

2 Pin definition

2.1 Pin assignment

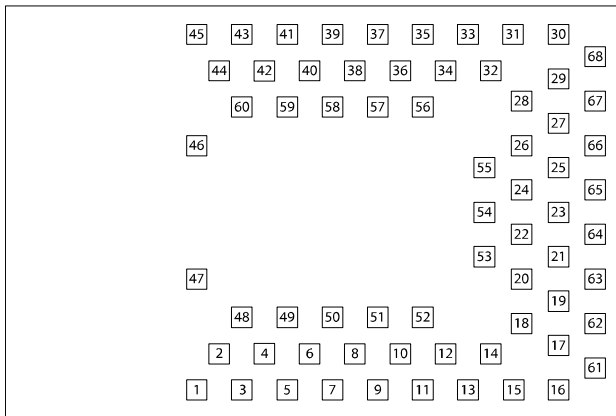

Figure 2: BMD-340 Pin assignment (Top view)

No.	Name	I/O	Description	nRF52 pin	Remarks
1	GND	Power	Electrical Ground		
2	GND	Power	Electrical Ground		
3	GND	Power	Electrical Ground		
4	GND	Power	Electrical Ground		
5	GND	Power	Electrical Ground		
6	P0.25	I/O	GPIO	P0.25	
7	P0.26	I/O	GPIO	P0.26	
8	P0.27	I/O	GPIO	P0.27	
9	P0.28	I/O	GPIO/AIN4	P0.28	Standard drive, low frequency I/O only (<10 kHz)
10	P0.29	I/O	GPIO/AIN5	P0.29	Standard drive, low frequency I/O only (<10 kHz)
11	P0.30	I/O	GPIO/AIN6	P0.30	Standard drive, low frequency I/O only (<10 kHz)
12	P0.31	I/O	GPIO/AIN7	P0.31	Standard drive, low frequency I/O only (<10 kHz)
13	P0.00	I/O	GPIO/XTAL1 (32.768 kHz)	P0.00	
14	P0.01	I/O	GPIO/XTAL2 (32.768 kHz)	P0.01	
15	P0.02	I/O	GPIO/AIN0	P0.02	Standard drive, low frequency I/O only (<10 kHz)
16	GND	Power	Electrical Ground		
17	VCC	Power I/O	LV Mode: 1.7 V to 3.6 V in HV Mode: 1.8 V to 3.3 V supply out ¹	VDD	An internal 4.7 μF bulk capacitor is included on the module. However, it is good design practice to add additional bulk capacitance as required for your application, i.e. those with heavy GPIO usage and/or current draw.
18	GND	Power	Electrical Ground		
19	P0.03	I/O	GPIO/AIN1	P0.03	Standard drive, low frequency I/O only (<10 kHz)
20	P0.04	I/O	GPIO/AIN2	P0.04	
21	P0.05	I/O	GPIO/AIN3	P0.05	
22	P0.06	I/O	GPIO	P0.06	
23	P0.07	I/O	GPIO/TRACECLK	P0.07	
24	P0.08	I/O	GPIO	P0.08	

¹ In HV mode, VCC acts as a regulated supply that can power other external devices. The voltage output of VCC can be configured in software but is limited to no more than VCCH-0.3 V. In System Off mode, VCC can supply no more than 1mA.

No.	Name	I/O	Description	nRF52 pin	Remarks
25	P0.09	I/O	GPIO/NFC1	P0.09	Standard drive, low frequency I/O only (<10 kHz)
26	P0.10	I/O	GPIO/NFC2	P0.10	Standard drive, low frequency I/O only (<10 kHz)
27	P0.11	I/O	GPIO/TRACEDATA[2]	P0.11	
28	P0.12	I/O	GPIO/TRACEDATA[1]	P0.12	
29	GND	Power	Electrical Ground		
30	GND	Power	Electrical Ground		
31	P0.13	I/O	GPIO	P0.13	
32	P0.14	I/O	GPIO	P0.14	
33	P0.15	I/O	GPIO	P0.15	
34	P0.16	I/O	GPIO	P0.16	
35	P0.17	I/O	GPIO	P0.17	
36	P0.21	I/O	GPIO	P0.21	
37	P0.19	I/O	GPIO	P0.19	
38	P0.20	I/O	GPIO	P0.20	
39	P0.18	I/O	GPIO/RESET	P0.18	
40	P0.22	I/O	GPIO	P0.22	
41	P0.23	I/O	GPIO	P0.23	
42	P0.24	I/O	GPIO	P0.24	
43	SWCLK	I	SWD Clock	SWCLK	
44	SWDIO	I/O	SWD IO	SWDIO	
45	GND	Power	Electrical Ground		
46	GND	Power	Electrical Ground		
47	GND	Power	Electrical Ground		
48	P1.05	I/O	GPIO	P1.05	Standard drive, low frequency I/O only (<10 kHz)
49	P1.06	I/O	GPIO	P1.06	Standard drive, low frequency I/O only (<10 kHz)
50	P1.07	I/O	GPIO	P1.07	Standard drive, low frequency I/O only (<10 kHz)
51	P1.08	I/O	GPIO	P1.08	
52	P1.09	I/O	GPIO/TRACEDATA[3]	P1.09	
53	P1.10	I/O	GPIO	P1.10	Standard drive, low frequency I/O only (<10 kHz)
54	P1.11	I/O	GPIO	P1.11	Standard drive, low frequency I/O only (<10 kHz)
55	GND	Power	Electrical Ground		
56	P1.00	I/O	GPIO/TRACEDATA[0]/SWO	P1.00	
57	P1.01	I/O	GPIO	P1.01	Standard drive, low frequency I/O only (<10 kHz)
58	P1.02	I/O	GPIO	P1.02	Standard drive, low frequency I/O only (<10 kHz)
59	P1.03	I/O	GPIO	P1.03	Standard drive, low frequency I/O only (<10 kHz)
60	P1.04	I/O	GPIO	P1.04	Standard drive, low frequency I/O only (<10 kHz)
61	P1.12	I/O	GPIO	P1.12	Standard drive, low frequency I/O only (<10 kHz)
62	P1.13	I/O	GPIO	P1.13	Standard drive, low frequency I/O only (<10 kHz)
63	P1.14	I/O	GPIO	P1.14	Standard drive, low frequency I/O only (<10 kHz)
64	P1.15	I/O	GPIO	P1.15	Standard drive, low frequency I/O only (<10 kHz)
65	VCCH	Power	LV Mode: Connect to VCC HV Mode: 2.5 V to 5.5 V in	VCCH	An internal 4.7 μ F bulk capacitor is included on the module. However, it is good design practice to add additional bulk capacitance as required for your application, i.e. those with heavy GPIO usage and/or current draw.

No.	Name	I/O	Description	nRF52 pin	Remarks
66	VBUS	Power	USB PHY supply: 4.35 V to 5.5 V in Connect to USB Host device 5 V supply	VBUS	Connect to USB Host device 5 V supply
67	USB-D-	I/O	USB Data-	USB-D-	
68	USB-D+	I/O	USB Data+	USB-D+	

Table 2: BMD-340 pin-out

2.2 Peripheral pins

The BMD-340 features a pin multiplexing system that allows most internal peripherals, such as UART and SPI, to be used on any GPIO pin. This freedom in pin choice enables better optimization of designs and PCB layout.

Only one peripheral signal can be multiplexed to a GPIO pin at a time. Some functions are restricted to certain pins due to additional internal circuitry required by the interface. These include: Trace signals, analog inputs, XTAL signals, USB signals, SWD interface, and reset. See Table 3.

Peripheral	Signal	Pin Options
UART0, UART1, I2C0, I2C1, SPI0, SPI1, SPI2, SPI3, I2S0, QSPI0, PDM0, PWM0, PWM1, PWM2, PWM3	All	P0.00-P0.31, P1.00-P1.15
ADC, COMP, LPCOMP	All	P0.02-P0.05, P0.28-P0.31 (AIN0-AIN7)
NFC	NFC1 NFC2	P0.09 P0.10
Reset	RESET	P0.18
Trace	TRACECLK SWO/TRACEDATA[0] TRACEDATA[1] TRACEDATA[2] TRACEDATA[3]	P0.07 P1.00 P0.12 P0.11 P1.09
SWD	SWD Clock SWD IO	SWCLK SWDIO
32.768 kHz Crystal	XTAL1 XTAL2	P0.00 P0.01
USB	USB Data + USB Data -	USB-D+ USB-D-

Table 3: Peripheral pin options

Some peripherals on the BMD-340 share the same memory location for their registers. This means that only one of these peripherals can be used at a time. It is possible to switch between peripherals that share the same register location by clearing and reinitializing the associated configuration registers. See Nordic Semiconductor nRF52840 Product Specification for details.

Peripheral ID	Base Address	Shared Peripherals
3	0x40003000	SPI0 I2C0
4	0x40004000	SPI1 I2C1

Table 4: Peripherals with shared registers

2.3 BMD-300 series footprint compatibility and migration

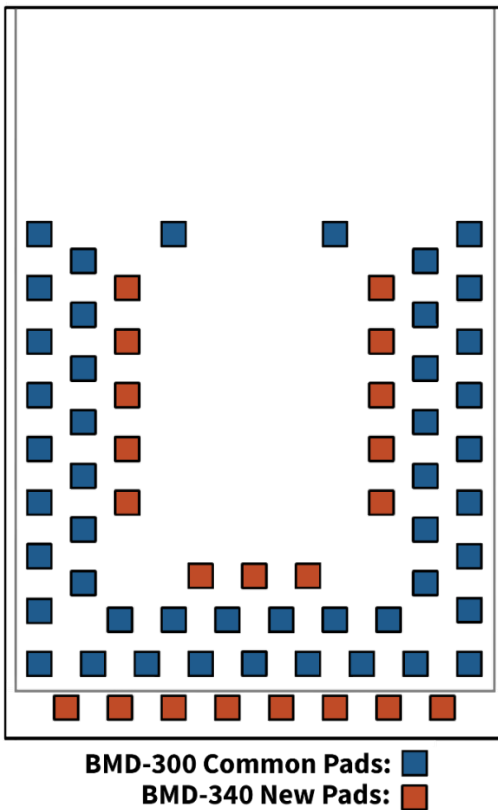

Figure 3: BMD-340 and BMD-300/301/330 footprint comparison

The BMD-340 footprint has been designed to allow for backwards compatibility with the BMD-300, BMD-301, BMD-330, and BMD-360 modules with pins 1 through 47 of the BMD-340 directly mapping to the same pin numbers on the BMD-300/301/330/360. This allows BMD-300, BMD-301, BMD-330 and BMD-360 modules to be placed directly onto the BMD-340 footprint for easy migration and enabling tiered product design.

Generally, all pin names and functions remain the same, except for some differences noted below. Pins 48 through 68 of the BMD-340 footprint are new pads used for new features that are not present on the BMD-300/301/330/360 modules, such as USB interface and additional GPIO and power connections.

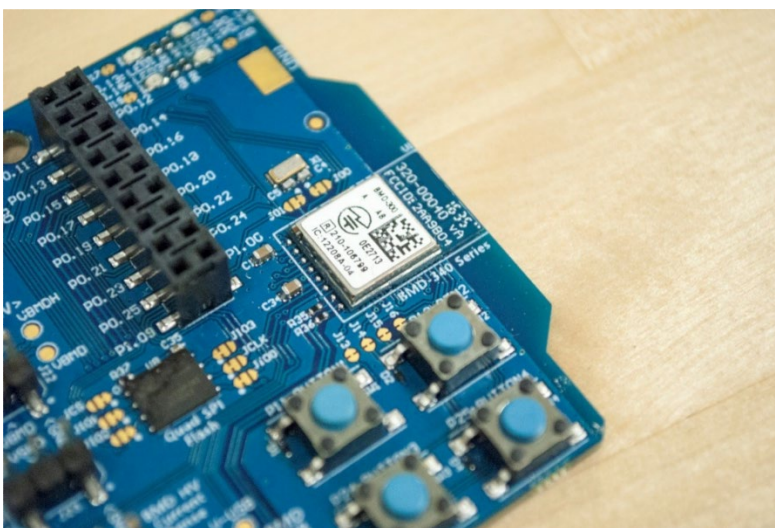

Figure 4: BMD-300 Module soldered to BMD-340 footprint

2.3.1 BMD-300/301/330/360 to BMD-340 pad differences

Due to changes in the nRF52840 SoC used by the BMD-340, not all functions (such as SWO/TRACE signals) are found on the same pins as on the BMD-300/301/330/360. Particularly of note is the reset pin function which on the BMD-340 is now available on P0.18 instead of P0.21 as on the BMD-300/301/330/360. To maintain pin for pin compatibility of the reset signal, P0.18 and P0.21 have swapped pad locations on the BMD-340 footprint. These differences are detailed in Table 5 below:

Pin	BMD-300/301 Name	BMD-300/301 Function	BMD-340 Name	BMD-340 Function
39	P0.21	GPIO/RESET	P0.18	GPIO/RESET
38	P0.20	GPIO/TRACECLK	P0.20	GPIO
36	P0.18	GPIO/TRACEDATA[0]/SWO	P0.21	GPIO
34	P0.16	GPIO/TRACEDATA[1]	P0.16	GPIO
33	P0.15	GPIO/TRACEDATA[2]	P0.15	GPIO
32	P0.14	GPIO/TRACEDATA[3]	P0.14	GPIO
23	P0.07	GPIO	P0.07	GPIO/TRACECLK
56	N/A	N/A	P1.00	GPIO/TRACEDATA[0]/SWO
28	P0.12	GPIO	P0.12	GPIO/TRACEDATA[1]
27	P0.11	GPIO	P0.11	GPIO/TRACEDATA[2]
52	N/A	N/A	P1.09	GPIO/TRACEDATA[3]

Table 5: BMD-300/301/330 to BMD-340 pad differences

2.3.2 BMD-300/301/330 to BMD-340 design migration

Existing designs incorporating the BMD-300, BMD-301, BMD-330 or BMD-360 module can be migrated over to the BMD-340 with the addition of a single footprint pad for VCCH (pin 65). This migration option is only suitable for applications that do not require the new USB interface, additional GPIO, or higher supply voltage functionality. The VCCH pad must be present and electrically connected to the same supply as VCC for the module to operate correctly. Vias underneath the BMD-340 should be tented to avoid shorts to unused module pads. Firmware written for the BMD-300/301/330 can generally be ported to the BMD-340 with minimal effort. See the Nordic Semiconductor SDK documentation for details.

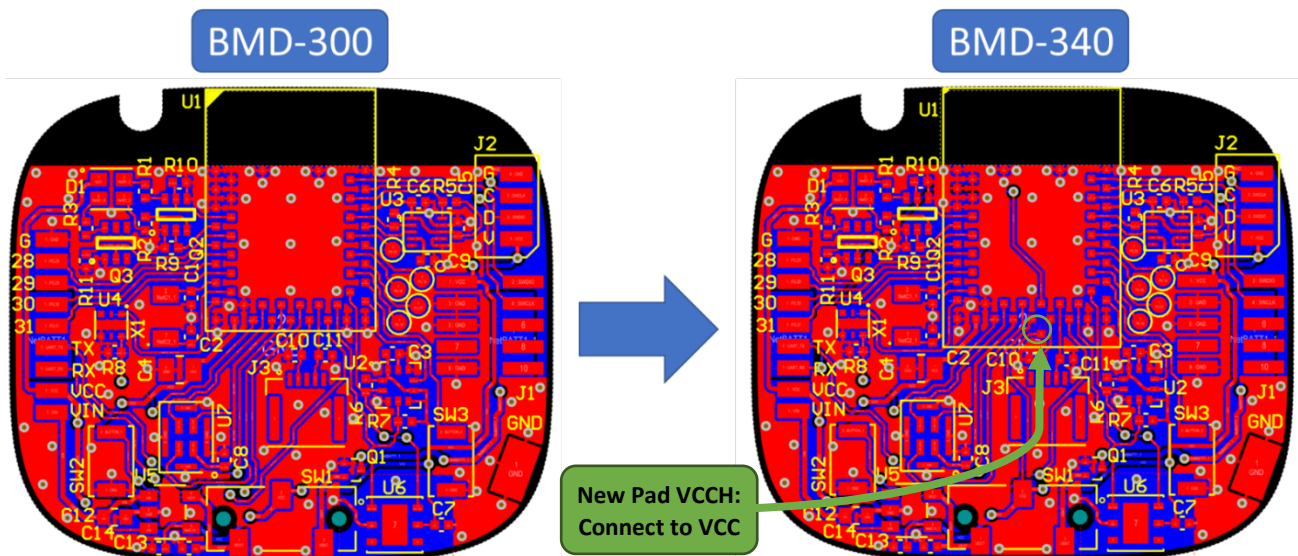



Figure 5: BMD-300 to BMD-340 Migration Example

Using the BMD-340 minimal footprint, with only the additional VCCH pad added, allows BMD-300 designs to gain the following BMD-340 features with typically minor layout re-work:

- Bluetooth 5 long range modes
- IEEE 802.15.4 (Thread and Zigbee) connectivity
- Doubled Flash memory (1MB vs. 512 KB)
- Quadrupled RAM (256 KB vs. 64 KB)
- Arm® TrustZone® Cryptocell 310 security co-processor

To take advantage of new hardware features, such as the additional UART and Quad SPI interface, the full BMD-340 footprint should be used. Designs that require the 5V DCDC converter, trace interface, USB interface, or the additional GPIO (P1.00-P1.15) must use the full BMD-340 footprint.

 Since the BMD-300/301/330/360 can be soldered to the full BMD-340 footprint, it is highly recommended that all new BMD-300 and BMD-340 projects use the full BMD-340 footprint. When migrating designs, the full BMD-340 footprint should be used whenever possible as it is better suited for use with mass production SMT processing.

2.4 BMD-340 fan-out example

The following figure is a BMD-340 fan-out example on a simple 2-layer PCB. This example is powered via VCCH from a USB connection. See section 3.3 for details on power and DCDC operation.

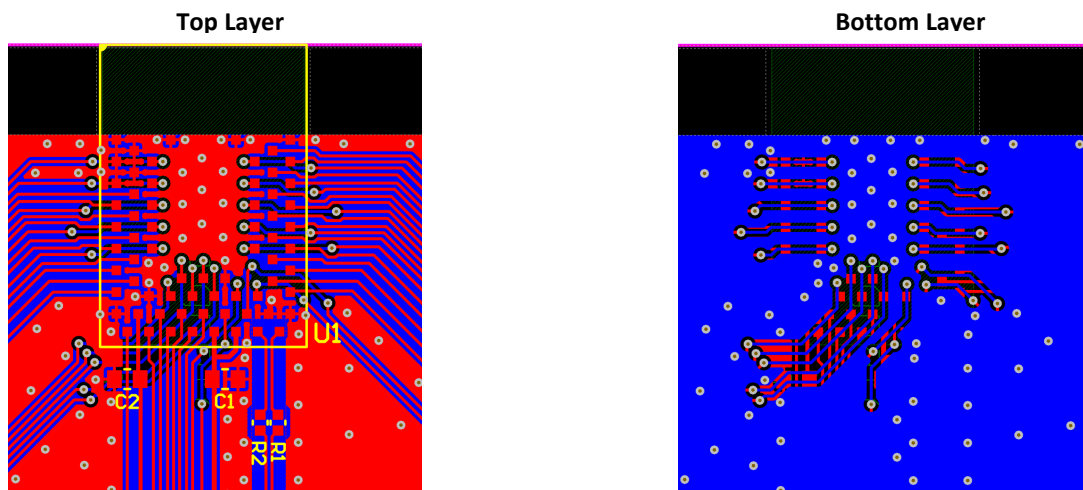

Figure 6: BMD-340 two-layer fan-out example

3 Electrical specifications

Stressing the device above one or more of the ratings listed in the Absolute maximum rating section may cause permanent damage. These are stress ratings only. Operating the module at these or at any conditions other than those specified in the Operating conditions section of this document should be avoided. Exposure to absolute maximum rating conditions for extended periods may affect device reliability.

Operating condition ranges define those limits within which the functionality of the device is guaranteed. Where application information is given, it is advisory only and does not form part of the specification.

3.1 Absolute maximum ratings

Symbol	Description	Min	Max	Unit
V_{CC_MAX}	Voltage on VCC supply pin	-0.3	3.9	V
V_{CCH_MAX}	Voltage on VCCH supply pin	-0.3	5.8	V
V_{BUS_MAX}	Voltage on VBUS supply pin	-0.3	5.8	V
V_{IO_MAX}	Voltage on GPIO pins ($V_{CC} > 3.6V$)	-0.3	3.9	V
V_{IO_MAX}	Voltage on GPIO pins ($V_{CC} \leq 3.6V$)	-0.3	$V_{CC}+0.3 V$	V
T_S	Storage Temperature Range	-40	125	°C

Table 6: Absolute maximum ratings

The product is not protected against overvoltage or reversed voltages. If necessary, voltage spikes exceeding the power supply voltage specification, given in table above, must be limited to values within the specified boundaries by using appropriate protection devices.

3.2 Operating conditions

Unless otherwise specified, all operating condition specifications are at an ambient temperature of 25 °C and a supply voltage of 3.3 V.

Operation beyond the specified operating conditions is not recommended and extended exposure beyond them may affect device reliability.

Symbol	Parameter	Min	Typ.	Max	Unit
V_{CC_IN}	VCC operating supply voltage in	1.7	3.0	3.6	V
V_{CC_START}	VCC DCDC starting voltage	1.75	-	-	V
V_{CCH_HV}	VCCH operating supply voltage in	2.5	5.0	5.5	V
V_{BUS_IN}	VBUS operating supply voltage in	4.35	5.0	5.5	V
T_{R_VCC}	VCC Supply rise time (0 V to 1.7 V)	-	-	60	ms
T_{R_VCCH}	VCCH Supply rise time (0 V to 3.7 V) ²	-	-	1	ms
T_A	Operating Ambient Temperature Range	-40	25	85	°C

Table 7: Operating conditions

² Applies when the module is configured to use HV mode. When using LV mode T_{R_VCC} applies. See Nordic Semiconductor nRF52840 Rev 1 errata [202] for details on T_{R_VCCH} requirement.

3.3 Power and DCDC configuration

The BMD-340 has two internal regulator stages that each contains an LDO and DCDC regulator. The first regulator, REG0, is fed by the VCCH pin and can accept a source voltage of 2.5 V to 5.5 V. The output of REG0 is connected to the VCC pin and the input of the second regulator stage REG1. REG1 supplies power to the module core and can accept an input source voltage of 1.7 V to 3.6 V. Depending on how the VCC and VCCH pins are connected, the module will operate in one of two modes: Normal/Low Voltage (LV) or High Voltage (HV). The voltage present on the VCC pin is always the GPIO high logic level voltage, regardless of power mode.

To enter LV Mode, the same source voltage is applied to both the VCC and VCCH pins causing REG0 to automatically shut down leaving only the REG1 stage active. To enter HV, the source voltage is only applied to VCCH causing the VCC pin to become an output source supplied by REG0.

Mode	Pin	Name	Connection
Normal (LV)	17	VCC	1.7 V to 3.6 V source in
	65	VCCH	Same source as VCC
High Voltage (HV)	17	VCC	1.8 V to 3.3 V supply out
	65	VCCH	2.5 V to 5.5 V source in

Table 8: Power mode pin connections

 **Important:** In both LV and HV mode, the GPIO logic level voltage is determined by the VCC pin. In HV mode, all external devices that are connected to the BMD-340's GPIO must either be powered by the module (from VCC) or use level translation.

REG0 can supply a maximum current of 25mA for the module and external circuits in System On Mode and 1 mA in System Off Mode. External circuits powered from VCC in HV mode should be limited to no more than 5mA to ensure stability at all radio transmit power levels.

 Important Note regarding REG0: Type number BMD-340-A-R-01 and newer use revision 2 of the Nordic Semiconductor nRF52840 silicon, while BMD-340-A-R-00 and engineering samples use revision 1. Revision 2 solves Nordic Semiconductor nRF52840 errata 197 and 202, while revision 1 is affected by those errata, affecting the REG0 regulator.

 For BMD-340-A-R-00 (nRF52840 silicon rev 1) the following thus applies: The REG0 DC-DC converter mode cannot be used reliably. The LDO mode of REG0 can be used in High Voltage mode but when applying power, the input voltage must have a rise time of 1ms or less. Due to the rise time constraint and higher current consumption of LDO mode compared to DCDC, High Voltage mode should be considered non-functional for most applications and should not be used.

BMD-340 type number	nRF52840 Silicon Version
BMD-340-A-R-00	Rev 1
BMD-340-A-R-01 and newer	Rev 2 or newer

Table 9: BMD-340 type number and silicon version

3.3.1 USB power

The USB interface on the BMD-340 can be used when the module is in either Normal (LV) or High Voltage (HV) mode. The BMD-340 USB PHY is powered by a dedicated, internal LDO regulator that is fed by the VBUS pin (66). This means that applying power to only the VBUS pin will not power the rest of the module. In order for the USB PHY to operate, VBUS must be externally powered.

3.3.2 Normal (LV) power mode examples

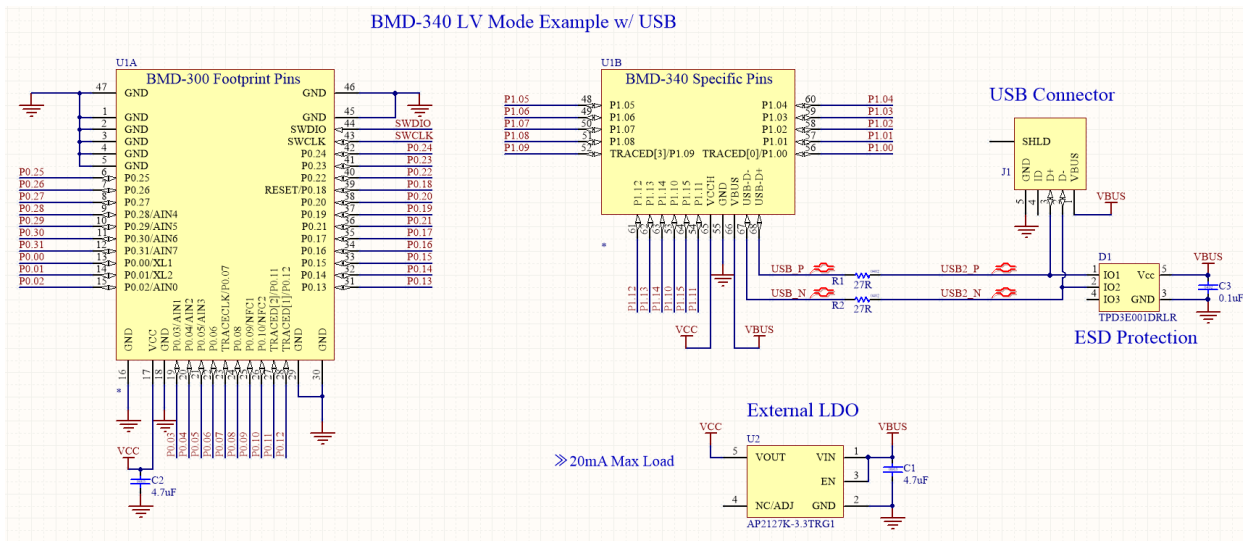
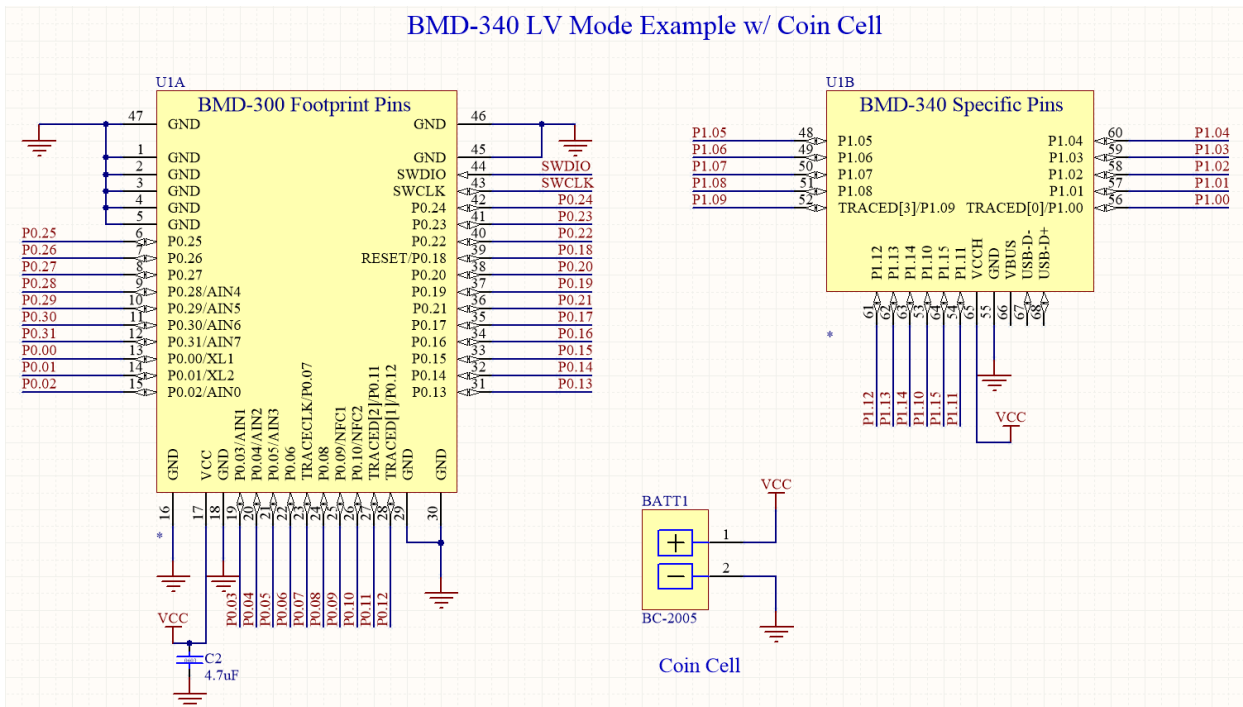

3.3.3 High voltage (HV) power mode examples

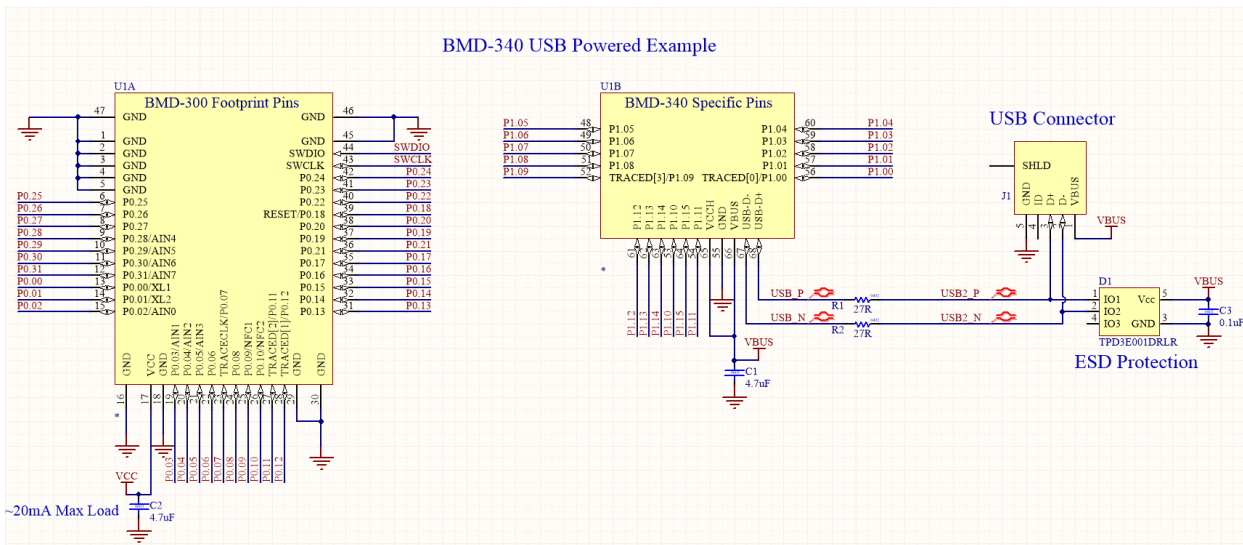

Figure 9: USB-powered HV mode example

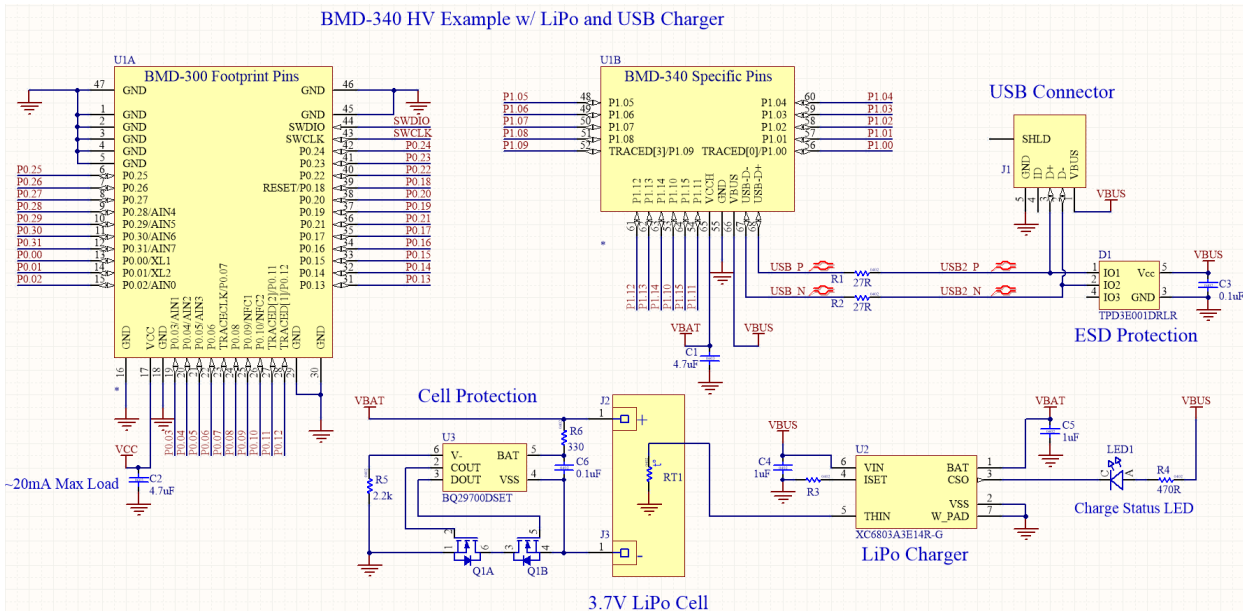

Figure 10: LiPo-powered HV example with USB charger

⚠ Important: The LiPo circuit above is meant to be a generic example of how the BMD-341's power modes can be used. Great care must be taken when integrating Lithium-Ion batteries into a design. Protection circuits suitable for the type of battery used and the application must always be implemented.

3.4 General purpose I/O

The general purpose I/O is organized as two ports enabling access and control of the 48 available GPIO pins. The first port allows access of P0.00 to P0.31, similar to the one port available on the BMD-300/301. The second port, new to the BMD-341, allows access to P1.00 to P1.15. Each GPIO can be accessed individually with the following user configurable features:

- Input/output direction
- Output drive strength
- Internal pull-up and pull-down resistors
- Wake-up from high- or low-level triggers on all pins
- Trigger interrupt on all pins
- All pins can be used by the PPI task/event system; the maximum number of pins that can be interfaced through the PPI at the same time is limited by the number of GPIOTE channels
- All pins can be individually configured to carry serial interface or quadrature demodulator signals

Symbol	Parameter	Min.	Typ.	Max.	Unit
V_{IH}	Input High Voltage	$0.7 \times VCC$	-	VCC	V
V_{IL}	Input Low Voltage	GND	-	$0.3 \times VCC$	V
V_{OH}	Output High Voltage	$VCC - 0.4$	-	VCC	V
V_{OL}	Output Low Voltage	GND	-	$GND + 0.4$	V
R_{PU}	Pull-up Resistance	11	13	16	k Ω
R_{PD}	Pull-down Resistance	11	13	16	k Ω

Table 10: GPIO electrical specifications

3.5 Module reset

GPIO pin P0.18 may be used for a hardware reset. In order to utilize P0.18 as a hardware reset, the UICR registers PSELRESET[0] and PSELRESET[1] must be set alike, to the value of 0x7FFFFFFD2. When P0.18 is programmed as RESET, the internal pull-up is automatically enabled. Nordic Semiconductor example applications and development kits program P0.18 as RESET_N.

3.6 Debug and programming

The BMD-340 series supports the two pin Serial Wire Debug (SWD) interface and offers flexible and powerful mechanism for non-intrusive debugging of program code. Breakpoints, single stepping, and instruction trace capture of code execution flow are part of this support.

The BMD-340 also supports ETM and ITM trace. The trace data from the ETM and the ITM is sent to an external debugger via a 4-bit wide parallel trace port. In addition to parallel trace, the TPIU supports serial trace via the Serial Wire Output (SWO) trace protocol.

3.7 Clocks

The BMD-340 requires two clocks, a high frequency clock and a low frequency clock. The high frequency clock is provided on-module by a high-accuracy 32 MHz crystal as required by the nRF528340 for radio operation.

The low frequency clock can be provided internally by an RC oscillator or synthesized from the fast clock, or externally by a 32.768 kHz crystal. An external crystal provides the lowest power consumption and greatest accuracy. Using the internal RC oscillator with calibration provides acceptable performance for Bluetooth low energy applications at a reduced cost and slight increase in power consumption.

3.7.1 32.768 kHz crystal (LFXO)

Symbol	Parameter	Typ.	Max.	Unit
F_{NOM_LFXO}	Crystal frequency	32.768	-	kHz
$F_{TOL_LFXO_BLE}$	Frequency tolerance, Bluetooth low energy applications ³	-	±500	ppm
$f_{TOL_LFXO_ANT}$	Frequency Tolerance, ANT applications ⁴	-	±50	ppm
C_{L_LFXO}	Load Capacitance	-	12.5	pF
C_{O_LFXO}	Shunt Capacitance	-	2	pF
R_{S_LFXO}	Equivalent series resistance	-	100	kΩ
C_{pin}	Input Capacitance on XL1 & XL2 pads	4	-	pF

Table 11: 32.768 kHz crystal (LFXO)

3.7.2 32.768 kHz clock source comparison

Symbol	Parameter	Min.	Typ.	Max.	Unit
I_{LFXO}	Current for 32.768 kHz Crystal Oscillator	-	0.23	-	μA
I_{LFRC}	Current for 32.768 kHz RC Oscillator	-	0.7	1	μA
I_{LFSYNT}	Current for 32.768 kHz Synthesized Oscillator	-	100	-	μA
$f_{TOL_LFXO_BLE}$	Frequency Tolerance, 32.768 kHz Crystal Oscillator (Bluetooth low energy Stack) ³	-	-	±500	ppm
$f_{TOL_LFXO_ANT}$	Frequency Tolerance, 32.768 kHz Crystal Oscillator (ANT Stack) ⁴	-	-	±50	ppm
f_{TOL_LFRC}	Frequency Tolerance, 32.768 kHz RC Oscillator	-	-	±5	%
$f_{TOL_CAL_LFRC}$	Frequency tolerance, 32.768 kHz RC after calibration	-	-	±500	ppm
f_{TOL_LFSYNT}	Frequency Tolerance, 32.768 kHz Synthesized Oscillator	-	-	±48	ppm

Table 12: 32.768 kHz clock source comparison

³ $f_{TOL_LFXO_BLE}$ and $f_{TOL_LFXO_ANT}$ are the maximum allowed for Bluetooth low energy and ANT applications. Actual tolerance depends on the crystal used.

⁴ The ANT protocol requires the use of an external crystal.

4 Firmware

Projects for the BMD-340 should utilize the [Nordic Semiconductor SDK](#) and the nRF52840 tools for new development. This will allow access to the very latest Bluetooth support from Nordic Semiconductor and provide an ongoing path as new features are released.

4.1 Factory image

The BMD-340 module is not loaded with a factory firmware image. The unique, public IEEE Bluetooth device address is printed on the module label and is also programmed into the UICR.

4.2 SoftDevices

Nordic Semiconductor protocol stacks for Bluetooth and ANT are known as SoftDevices. SoftDevices are pre-compiled, pre-linked binary files. SoftDevices can be programmed in nRF52 series SoCs and are downloadable from the Nordic Semiconductor website. The BMD-340 with the nRF52840 SoC supports the S140 (Bluetooth low energy Central & Peripheral) and S340 (ANT and Bluetooth low energy) SoftDevices.

4.2.1 S140

The SoftDevice S140 is a feature complete Bluetooth 5 qualified protocol stack for the nRF52840 SoC. It supports up to 20 concurrent links in all roles. It supports Bluetooth 5 features: 2 Mbps, Long Range, Advertising Extensions and channel selection algorithm #2(CSA #2). The number of connections and bandwidth per connection are configurable, offering memory and performance optimization.

It is a complete stack with GAP, GATT, ATT, SM, L2CAP, and Link Layer. Both GATT Server and Client are supported. The broad feature set also includes Privacy 1.2, LE Data Length Extension (DLE), configurable ATT MTU, L2CAP connection-oriented channels and LE Secure Connections.

SoftDevice S140 is available for download [here](#).

4.2.2 S340

SoftDevice S340 is a combined Bluetooth 5 and ANT™ protocol stack for the nRF52840 SoC, supporting concurrent operation of the two.

It is a Bluetooth 5 qualified protocol stack that offers up to 20 concurrent links in all roles. It supports all Bluetooth 5 features: 2 Mbps, Long Range, Advertising Extensions and channel selection algorithm #2 (CSA #2). The number of connections and bandwidth per connection is configurable, offering memory and performance optimization.

It is a complete Bluetooth LE stack with GAP, GATT, ATT, SM, L2CAP, and Link Layer. Both GATT Server and Client are supported. The broad feature set also includes Privacy 1.2, LE Data Length Extension (DLE), configurable ATT MTU, L2CAP connection-oriented channels and LE Secure Connections.

It supports all ANT features and offers a variety of network topologies, including peer-to-peer, star and tree. Up to 15 individual channels are available, with broadcast, acknowledged, or burst transfer communication.

SoftDevice S340 is available for download [here](#).

4.2.3 IEEE 802.15.4 (Thread and Zigbee)

IEEE 802.15.4 based protocols, such as Thread and Zigbee, on the BMD-340 are not implemented using a SoftDevice. Nordic Semiconductor provides an IEEE 802.15.4 compliant MAC stack which does not require a SoftDevice to be loaded to operate. Nordic Semiconductor also provides pre-compiled Thread and Zigbee stacks. See the [Nordic Semiconductor SDK](#) for more information on developing applications that utilize IEEE 802.15.4. Both allow for concurrent operation with Bluetooth low energy SoftDevices.

4.3 Bluetooth device address

The BMD-340 module is preprogrammed from the factory with a unique public Bluetooth device (MAC) address stored in the CUSTOMER[0] and CUSTOMER[1] registers of the User Information Configuration Registers (UICR). The Bluetooth device address consists of the IEEE Organizationally Unique Identifier (OUI) combined with the six hexadecimal digits that are printed on a 2D barcode and in human-readable text on the module label, as described in section 5.3. The Bluetooth device address is stored in little endian format. The most significant bytes of the CUSTOMER[1] register are 0xFF to complete the 32-bit register.

UICR Register	Address	Description	Remarks
CUSTOMER[0]	0x10001080	Bluetooth_addr [0] (0xFF)	Example value. Actual value printed on label
CUSTOMER[0]	0x10001081	Bluetooth_addr [1] (0xEE)	Example value. Actual value printed on label
CUSTOMER[0]	0x10001082	Bluetooth_addr [2] (0xDD)	Example value. Actual value printed on label
CUSTOMER[0]	0x10001083	Bluetooth_addr [3] (0xCC)	IEEE OUI ^{5,6}
CUSTOMER[1]	0x10001084	Bluetooth_addr [4] (0xBB)	IEEE OUI ^{5,6}
CUSTOMER[1]	0x10001085	Bluetooth_addr [5] (0xAA)	IEEE OUI ^{5,6}
CUSTOMER[1]	0x10001086	0xFF	Unused
CUSTOMER[1]	0x10001087	0xFF	Unused

Table 13: Bluetooth device address

⁵ The IEEE OUI for type numbers BMD-340-A-R-00 and BMD-340-A-R-01 is: 94:54:93. The full Bluetooth device address is stored in the UICR.

⁶ Type number BMD-340-A-R-10 encodes the full Bluetooth device address in the label data matrix and is stored in the UICR.

5 Mechanical specifications

5.1 Dimensions

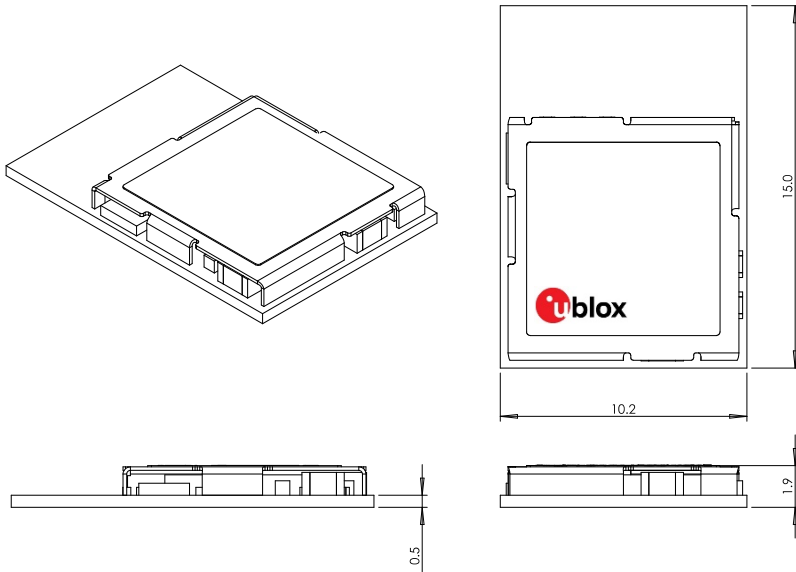

Length: ± 0.3 mm, Width: ± 0.3 mm, Height: ± 0.1 mm

Figure 11: BMD-340 mechanical drawing

5.2 Recommended PCB land pads

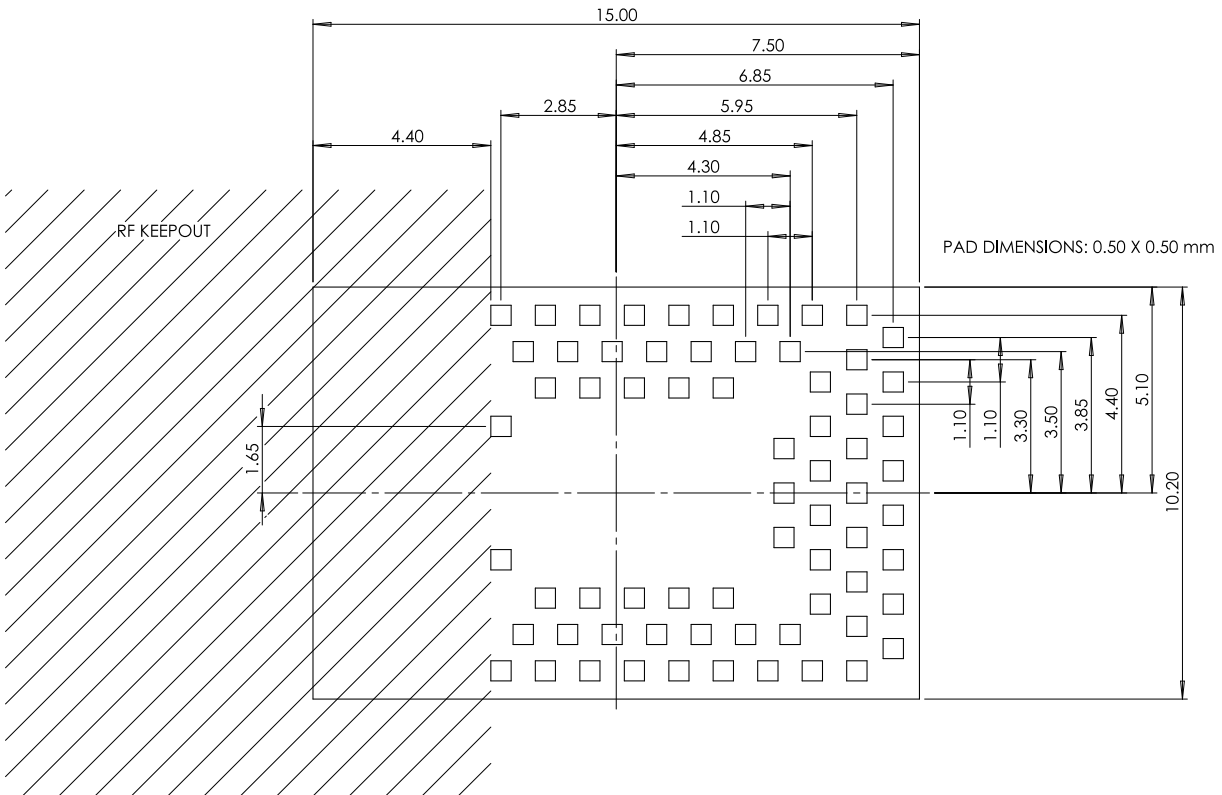

Figure 12: Recommended PCB land pads

5.3 Module marking

5.3.1 Module marking for type number BMD-340-A-R-00

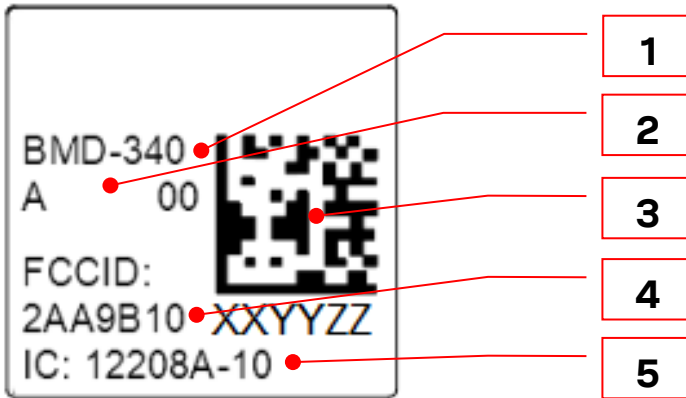

Figure 13: Module marking for type number BMD-340-A-R-00

Reference	Description
1	Product name
2	No marking here indicates nRF52840 Revision 1 silicon
3	Data Matrix with unique serial number of six alphanumeric symbols, also in human-readable form. The full Bluetooth address consists of the IEEE OUI (94:54:93) with the six symbols appended: Example value: 94:54:93:XX:YY:ZZ
4	FCC ID (USA)
5	ISED ID (Canada)

Table 14: Module marking for type number BMD-340-A-R-00

5.3.2 Module marking for type number BMD-340-A-R-01

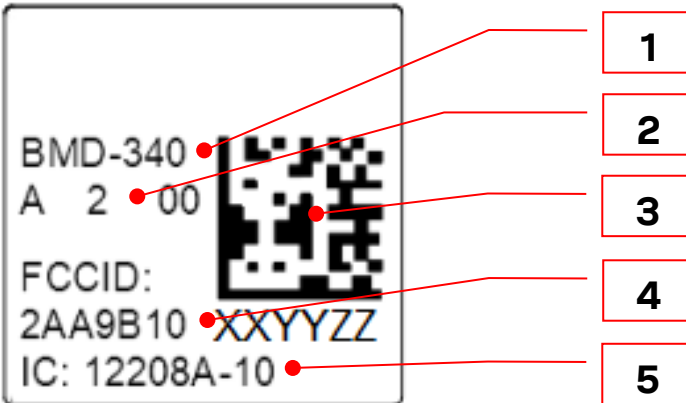

Figure 14: Module marking for type number BMD-340-A-R-01

Reference	Description
1	Product name
2	“2” indicates nRF52840 Revision 2 silicon
3	Data Matrix with unique serial number of six alphanumeric symbols, also in human-readable form. The full Bluetooth address consists of the IEEE OUI (94:54:93) with the six symbols appended: Example value: 94:54:93:XX:YY:ZZ
4	FCC ID (USA)
5	ISED (IC) ID (Canada)

Table 15: Module marking for type number BMD-340-A-R-01

5.3.3 Module marking for type number BMD-340-A-R-10

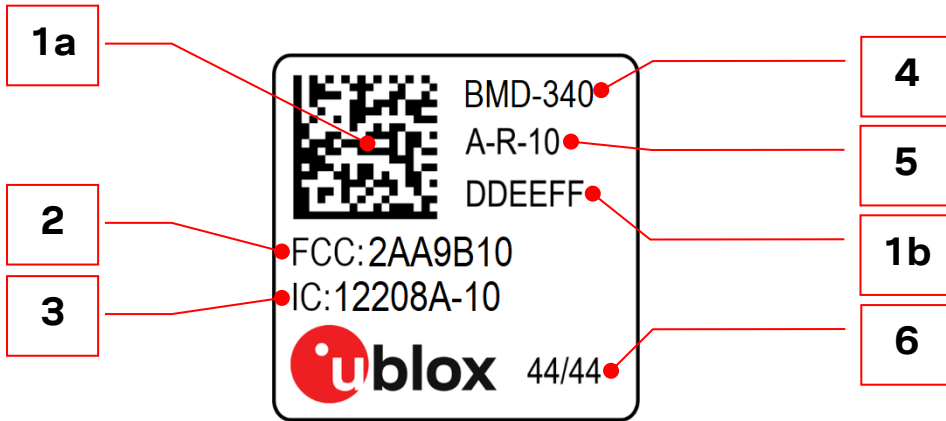

Figure 15: Module marking for type number BMD-340-A-R-10

Reference	Description
1a	Data Matrix with unique serial number of 19 alphanumeric symbols. The first 3 symbols represent module type number unique to each module variant, the next 12 symbols represent the unique hexadecimal Bluetooth device address of the module AABBCCDDEEFF, and the last 4 symbols represent the hardware and firmware version encoded HHFF.
1b	Second half of Bluetooth device address in human-readable format (DDEEFF above)
2	FCC ID (USA)
3	ISED (IC) ID (Canada)
4	Product name (Model)
4+5	Product type number
6	Date of production encoded YY/WW (year / week)

Table 16: Module marking for type number BMD-340-A-R-10

6 RF Design notes

6.1 Recommended RF layout and ground plane

The integrated antenna requires a suitable ground plane to radiate effectively.

The area under and extending out from the antenna portion of the module should be kept clear of copper and other metal. The module should be placed at the edge of the PCB with the antenna edge facing out. Reducing the ground plane from that shown in Figure 16 will reduce the effective radiated power.

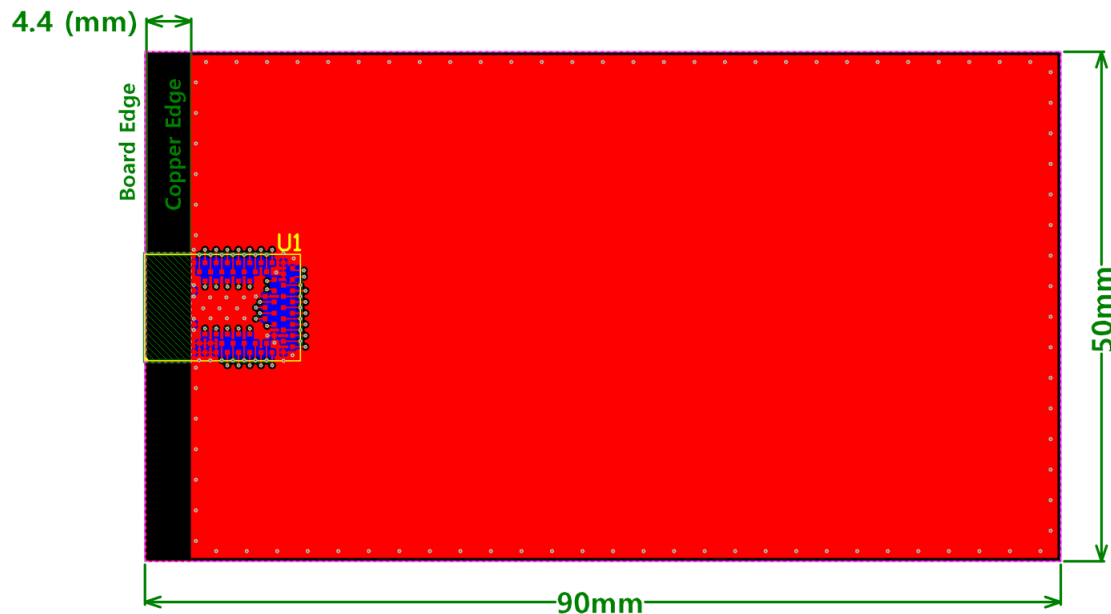

Figure 16: BMD-340 RF example based on the evaluation board

6.2 Mechanical enclosure

Care should be taken when designing and placing the module into an enclosure. Metal should be kept clear from the antenna area, both above and below. Any metal around the module can negatively impact RF performance.

The module is designed and tuned for the antenna and RF components to be in free air. Any potting, epoxy fill, plastic over-molding, or conformal coating can negatively impact RF performance and must be evaluated by the customer.

6.3 Antenna patterns

Antenna patterns are based on the BMD-340 Evaluation Kit with a ground plane size of 109 mm x 56 mm. The X-Y-Z orientation is shown in Figure 17:

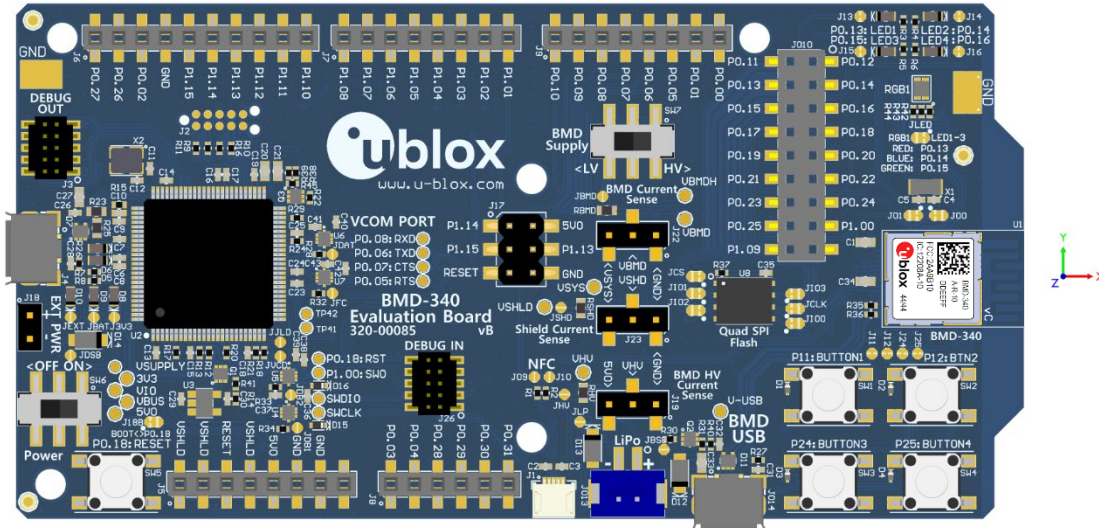
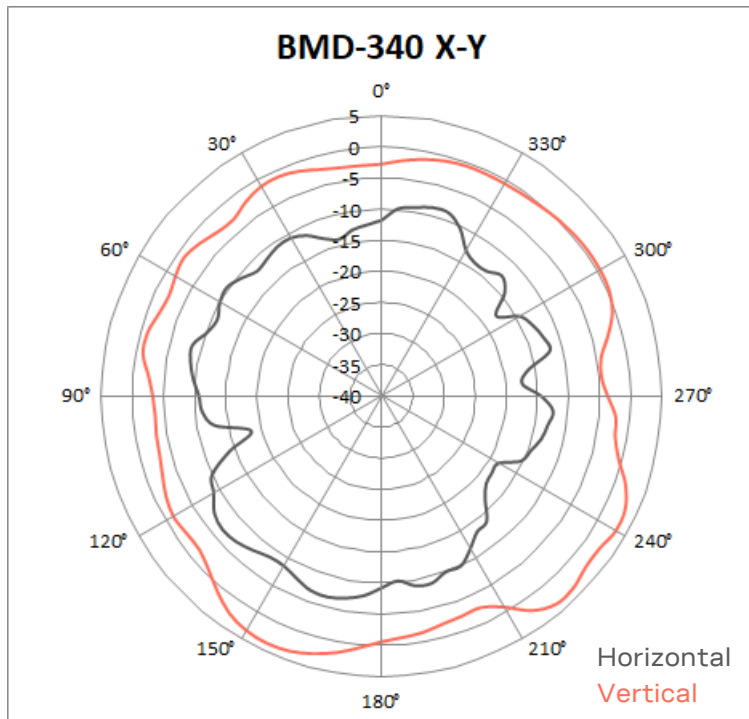
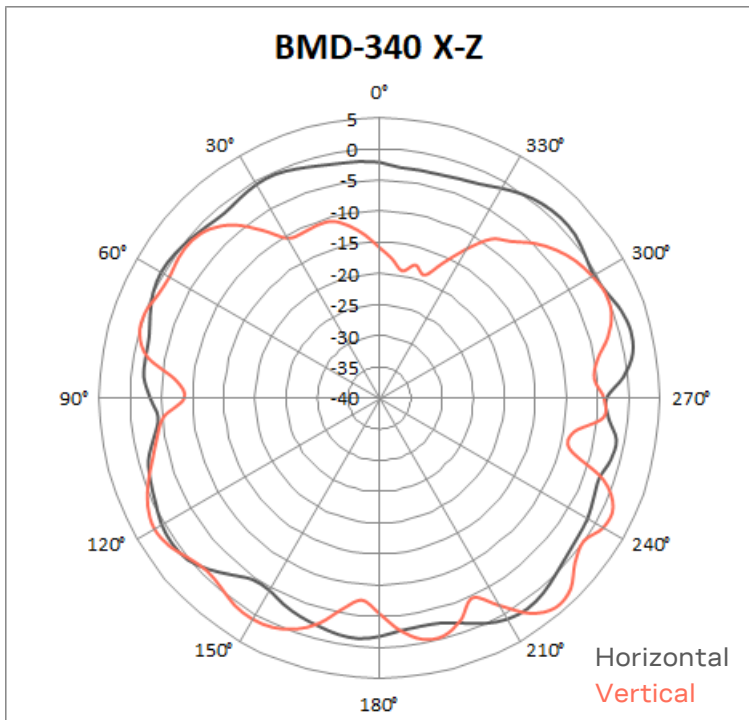

Figure 17: BMD-340 evaluation kit X-Y-Z orientation

6.3.1 X-Y plane



6.3.2 X-Z plane



6.3.3 Y-Z plane

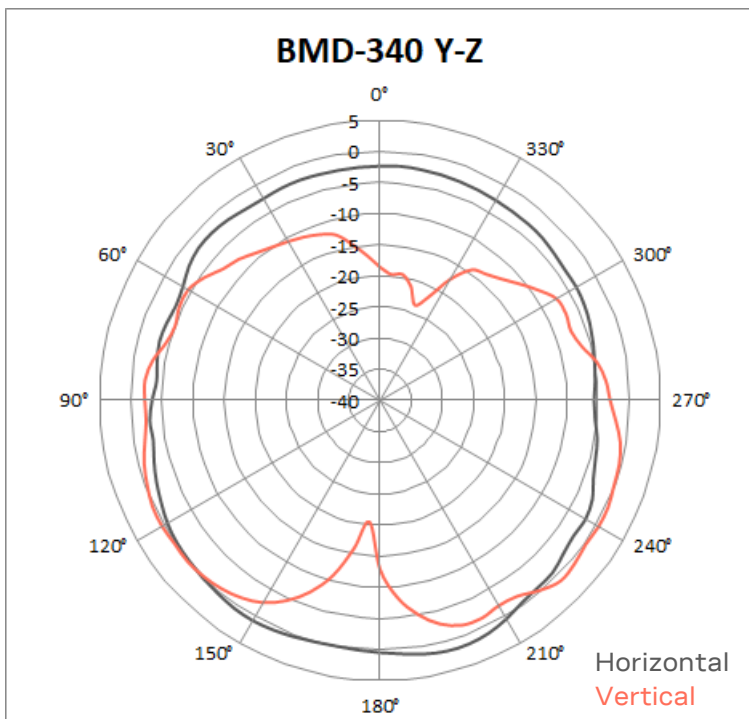

7 BMD-340 evaluation development kit



u-blox has developed full featured evaluation boards that provide a complete I/O pin out to headers, on-board programming and debugging, 32.768 kHz crystal, power and virtual COM port over USB, BMD-340 USB connector, 64 Mb quad SPI Flash, four user LEDs, and four user buttons. The evaluation boards also provide the option to be powered from a CR2032 coin cell battery or a LiPo battery through a JST-PH connector and have current sense resistors and headers to allow for convenient current measurements. Arduino Mega style headers are provided for easy prototyping of additional functions. The evaluation boards also support programming off-board u-blox modules based on Nordic Semiconductor nRF5 SoCs.

8 Qualification and approvals

8.1 United States (FCC)

The BMD-340 module has received Federal Communications Commission (FCC) CFR47 Telecommunications, Part 15 Subpart C “Intentional Radiators” modular approval in accordance with Part 15.212 and 15.247. The modular approval allows the end user to integrate the module into a finished product without obtaining subsequent and separate FCC approvals for intentional radiation, provided no changes or modifications are made to the module circuitry. Changes or modifications could void the user’s authority to operate the equipment. The end user must comply with all of the instructions provided by the Grantee, which indicate installation and/or operating conditions necessary for compliance.

The finished product is required to comply with all applicable FCC equipment authorizations regulations, requirements and equipment functions not associated with the transmitter module portion. For example, compliance must be demonstrated to regulations for other transmitter components within the host product; to requirements for unintentional radiators (Part 15 Subpart B “Unintentional Radiators”), such as digital devices, computer peripherals, radio receivers, etc.; and to additional authorization requirements for the non-transmitter functions on the transmitter module (that is, Verification, or Declaration of Conformity) (for example, transmitter modules may also contain digital logic functions) as appropriate.

-  Modification to this product will void the users’ authority to operate this equipment.
-  The OEM is still responsible for verifying end product compliance with FCC Part 15, subpart B limits for unintentional radiators through an accredited test facility.

8.1.1 Labeling and user information requirements

The BMD-340 is assigned the FCC ID number: 2AA9B10

If the FCC ID is not visible when the module is installed inside another device, then the outside of the finished product into which the module is installed must also display a label referring to the enclosed module. This exterior label can use the following or similar wording:

Contains FCC ID: 2AA9B10

In addition to marking the product with the appropriate FCC ID, the end product shall bear the following statement in a conspicuous location on the device ([FCC Rules, Title 47, Subchapter A, Part 15, Subpart B, Chapter §15.19](#)):

This device complies with part 15 of the FCC Rules. Operation is subject to the following two conditions: (1) This device may not cause harmful interference, and (2) this device must accept any interference received, including interference that may cause undesired operation.

8.1.2 RF exposure

All transmitters regulated by FCC must comply with RF exposure requirements. [KDB 447498 General RF Exposure Guidance](#) provides guidance in determining whether proposed or existing transmitting facilities, operations or devices comply with limits for human exposure to Radio Frequency (RF) fields adopted by the Federal Communications Commission (FCC).

This module is approved for installation into mobile and/or portable host platforms and must not be co-located or operating in conjunction with any other antenna or transmitter except in accordance with FCC multi-transmitter guidelines. End users must be provided with transmitter operating conditions for satisfying RF Exposure compliance.

8.2 Canada (ISED)

The BMD-340 module is certified for use in Canada under Innovation, Science and Economic Development Canada (ISED) Radio Standards Specification (RSS) RSS-247 and RSSGen.

8.2.1 Labeling and user information requirements

The BMD-300 is assigned the IC ID number: 12208A-10

Labeling Requirements for the Host Device (from Section 3.2.1, RSS-Gen, Issue 3, December 2010): The host device shall be properly labeled to identify the module within the host device. The Industry Canada certification label of a module shall be clearly visible at all times when installed in the host device, otherwise the host device must be labeled to display the Industry Canada certification number of the module, preceded by the words “Contains transmitter module”, or the word “Contains”, or similar wording expressing the same meaning, as follows:

Contains transmitter module IC: 12208A-10

User Manual Notice for License-Exempt Radio Apparatus (from Section 7.1.3 RSS-Gen, Issue 3, December 2010): User manuals for license-exempt radio apparatus shall contain the following or equivalent notice in a conspicuous location in the user manual or alternatively on the device or both:

This device complies with Industry Canada license exempt RSS standard(s). Operation is subject to the following two conditions: (1) this device may not cause interference, and (2) this device must accept any interference, including interference that may cause undesired operation of the device.

Le présent appareil est conforme aux CNR d'Industrie Canada applicables aux appareils radio exempts de licence. L'exploitation est autorisée aux deux conditions suivantes: (1) l'appareil ne doit pas produire de brouillage, et (2) l'utilisateur de l'appareil doit accepter tout brouillage radioélectrique subi, même si le brouillage est susceptible d'en compromettre le fonctionnement.

Transmitter Antenna (from Section 7.1.2 RSS-Gen, Issue 3, December 2010): User manuals for transmitters shall display the following notice in a conspicuous location:

Under Industry Canada regulations, this radio transmitter may only operate using an antenna of a type and maximum (or lesser) gain approved for the transmitter by Industry Canada. To reduce potential radio interference to other users, the antenna type and its gain should be so chosen that the equivalent isotropically radiated power (e.i.r.p.) is not more than that necessary for successful communication.

Conformément à la réglementation d'Industrie Canada, le présent émetteur radio peut fonctionner avec une antenne d'un type et d'un gain maximal (ou inférieur) approuvé pour l'émetteur par Industrie Canada. Dans le but de réduire les risques de brouillage radioélectrique à l'intention des autres utilisateurs, il faut choisir le type d'antenne et son gain de sorte que la puissance isotrope rayonnée équivalente (p.i.r.e.) ne dépasse pas l'intensité nécessaire à l'établissement d'une communication satisfaisante.

8.2.2 RF exposure

All transmitters regulated by ISED must comply with RF exposure requirements listed in RSS-102 - Radio Frequency (RF) Exposure Compliance of Radiocommunication Apparatus (All Frequency Bands). This module is approved for installation into mobile and/or portable host platforms and must not be co-located or operating in conjunction with any other antenna or transmitter except in accordance with Industry Canada's multi-transmitter guidelines. End users must be provided with transmitter operating conditions for satisfying RF Exposure compliance.

8.3 European Union regulatory compliance

Information about regulatory compliance of the European Union for the BMD-340 module is available in the BMD-340 Declaration of Conformity.

8.3.1 Radio Equipment Directive (RED) 2014/53/EU

The BMD-340 module complies with the essential requirements and other relevant provisions of Radio Equipment Directive (RED) 2014/53/EU.

8.4 Australia / New Zealand (RCM)

The BMD-340 has been tested to comply with the AS/NZS 4268:2017, Radio equipment and systems – Short range devices – Limits and methods of measurement. The report may be obtained from your local FAE, and may be used as evidence in obtaining permission to use the Regulatory Compliance Mark (RCM).

Information on registration as a Responsible Party, license and labeling requirements may be found at the following websites:

Australia: <http://www.acma.gov.au/theACMA/radiocommunications-short-range-devices-standard-2004>

New Zealand: <http://www.rsm.govt.nz/compliance>

Only Australian-based and New Zealand-based companies who are registered may be granted permission to use the RCM. An Australian-based or New Zealand-based agent or importer may also register as a Responsible Party to use the RCM on behalf of a company not in Australia or New Zealand.

8.5 Japan (MIC)

MIC applies to type number BMD-340-A-R-10 and newer.

The BMD-340 module has received type certification and conforms to the technical standards regulated by the Ministry of Internal Affairs and Communications (MIC) of Japan pursuant to the Radio Act of Japan. Integration of this module into a final end product does not require additional radio certification provided installation instructions are followed and no modifications of the module are allowed. Additional testing may be required:

- If the host product is subject to electrical appliance safety (for example, powered from an AC mains), the host product may require Product Safety Electrical Appliance and Material (PSE) testing. The integrator should contact their conformance laboratory to determine if this testing is required.
- There is a voluntary Electromagnetic Compatibility (EMC) test for the host product administered by VCCI: http://www.vcci.jp/vcci_e/index.html

The label on the end product which contains a BMD-340 module must follow the MIC marking requirements. Labeling requirements for Japan available at the Ministry of Internal Affairs and Communications (MIC) website: <http://www.tele.soumu.go.jp/e/index.htm>.

The BMD-340 module is assigned the technical conformity mark and certification number noted in Figure 18 below. The end product in which this module is being used must have an external label referring to the type certified module inside:

Contains transmitter module with certificate number:

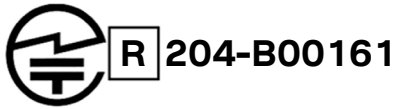

Figure 18: Japan technical conformity mark and certification number

8.6 Bluetooth qualification

The Bluetooth SIG maintains the Bluetooth Specification, and ensures that products are properly tested and comply with the Bluetooth license agreements. Companies that list products with the Bluetooth SIG are required to be members of the SIG and submit the listed fees. Refer to this link for details: <https://www.bluetooth.com/develop-with-bluetooth/qualification-listing>

The BMD-340 Bluetooth low energy module based on Nordic Semiconductor SoCs is listed as a “Tested Component”. This allows an end product based on a u-blox module to inherit the component listings without the need to run all of the tests again. The end product will often inherit several different listings, known as Qualified Design IDs (QDID), and are identified on a “Declaration of Compliance”.

The list of qualified products is found here: <https://launchstudio.bluetooth.com/Listings/Search>

The BMD-340 primarily utilizes the S140 SoftDevice.

9 Environmental

9.1 RoHS

BMD-340 modules are in compliance with Directive 2011/65/EU, 2015/863/EU of the European Parliament and the Council on the restriction of the use of certain hazardous substances in electrical and electronic equipment.

9.2 REACH

BMD-340 modules do not contain the [SVHC \(Substance of Very High Concern\)](#), as defined by Directive EC/1907/2006 Article according to REACH Annex XVII.

9.3 California proposition 65 (P65)

This product can expose you to Nickel (metallic), which is known to the State of California to cause cancer. For more information go to www.P65Warnings.ca.gov.

 Warnings are not required where the listed chemical is inaccessible to the average user of the end product.

10 Product handling

10.1 Packaging

10.1.1 Reel packaging for type number BMD-340-A-R-00 and BMD-340-A-R-01

Modules are packaged on 330 mm reels loaded with 1000 modules. Each reel is placed in an antistatic bag with a desiccant pack and humidity card and placed in a 340 x 350 x 65 mm box. An antistatic warning and reel label are adhered to the outside of the bag.

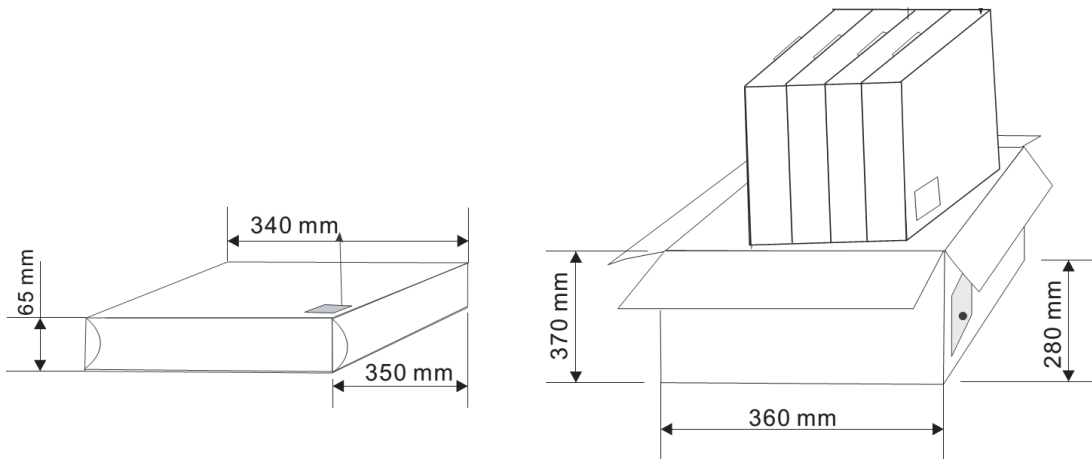
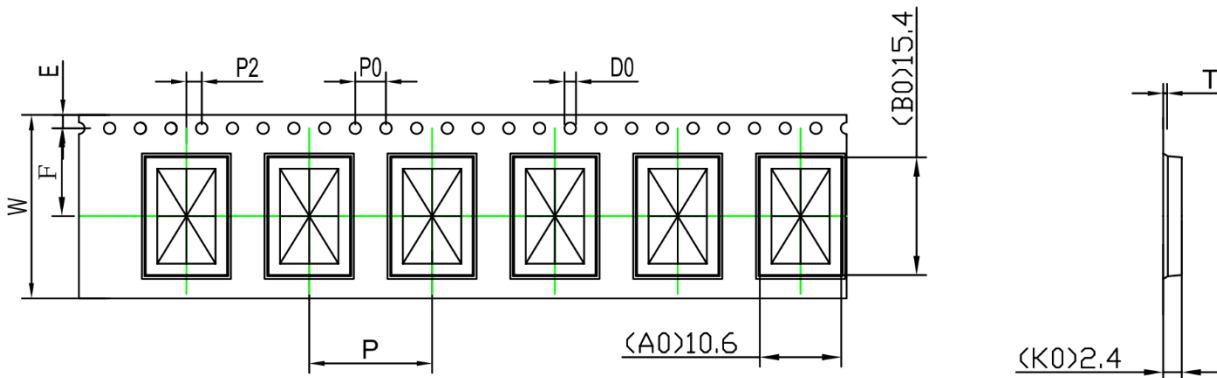

Figure 19 – Reel cartons used for type number BMD-340-A-R-00 and BMD-340-A-R-01

10.1.2 Reel packaging for type number BMD-340-A-R-10

Modules are packaged on 330 mm reels loaded with 1000 modules. Each reel is placed in an antistatic bag with a desiccant pack and humidity card and placed in a 370x355x56 mm box. See the u-blox Package Information Guide [1] for full specifications on reel dimensions, box sizes and shipping label content. BMD-340-A-R-10 modules use u-blox reel type A3.

10.1.3 Carrier tape dimensions for type number BMD-340-A-R-00 and BMD-340-A-R-01



ITEM	W	A ₀	B ₀	K ₀	K ₁	P	F	E	D ₀	D ₁	P ₀	P ₂	T
DIM	24.0 ^{+0.30} _{-0.30}	10.60 ^{+0.10} _{-0.10}	15.4 ^{+0.10} _{-0.10}	2.40 ^{+0.10} _{-0.10}	0.00 ^{+0.00} _{-0.00}	16.0 ^{+0.10} _{-0.10}	11.5 ^{+0.10} _{-0.10}	1.75 ^{+0.10} _{-0.10}	1.50 ^{+0.10} _{-0.00}	0.00 ^{+0.10} _{-0.00}	4.00 ^{+0.10} _{-0.10}	2.00 ^{+0.10} _{-0.10}	0.30 ^{+0.05} _{-0.05}
ALTERNATE													

Figure 20 – BMD-340-A-R-00 and BMD-340-A-R-01 carrier tape dimensions

10.1.4 Carrier tape dimensions for type number BMD-340-A-R-10

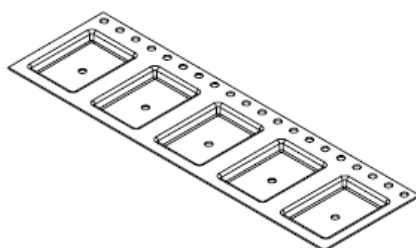
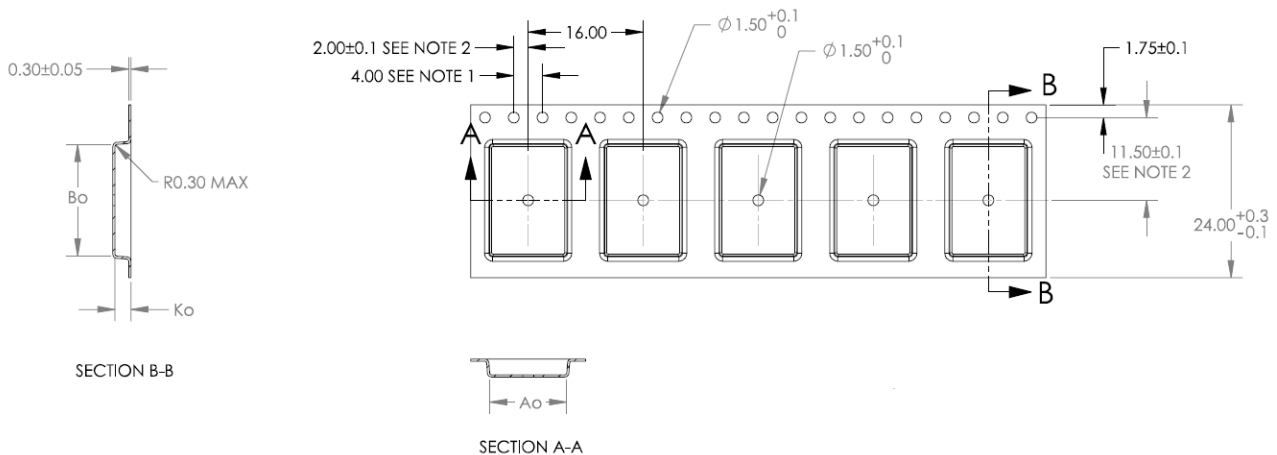

	DIM	±
A ₀	10.70	0.1
B ₀	15.50	0.1
K ₀	2.20	0.1

NOTES:

- 10 SPROCKET HOLE PITCH CUMULATIVE TOLERANCE ± 0.2
- POCKET POSITION RELATIVE TO SPROCKET HOLE MEASURED AS TRUE POSITION OF POCKET, NOT POCKET HOLE.
- A₀ AND B₀ ARE MEASURED ON A PLANE AT A DISTANCE "R" ABOVE THE BOTTOM OF THE POCKET.

Figure 21: BMD-340-A-R-10 carrier tape dimensions

10.2 Moisture sensitivity level

The BMD-340 Series is rated for MSL 3, 168-hour floor life after opening.

10.3 Reflow soldering

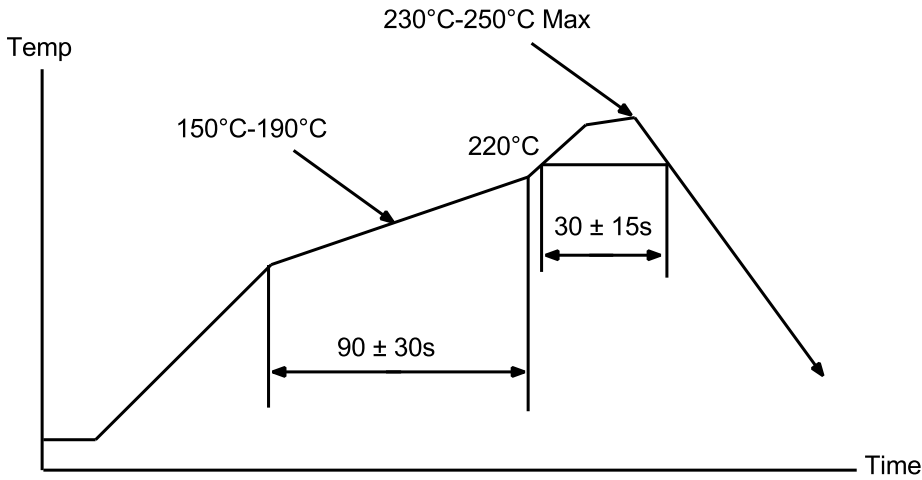

Figure 22: Reflow Profile for Lead Free Solder

10.4 ESD precautions

- ⚠ The BMD-340 module contains highly sensitive electronic circuitry and is an Electrostatic Sensitive Device (ESD). Handling the BMD-340 module without proper ESD protection may destroy or damage them permanently.

Proper ESD handling and packaging procedures must be applied throughout the processing, handling and operation of any application that incorporates the BMD-340 module. Failure to observe these recommendations can result in severe damage to the device.

11 Ordering information

Ordering Code	Product
BMD-340-A-R	BMD-340 module, nRF52840-QIAA, Tape & Reel, 1000 pieces per reel Type number BMD-340-A-R-00 uses nRF52840-QIAA rev 1 Type number BMD-340-A-R-01 and above uses nRF52840-QIAA rev 2
BMD-340-EVAL	BMD-340 evaluation kit w/ SEGGER J-Link-OB debug probe

Table 17: Product ordering codes

12 Life support and other high-risk use warning

This product is neither designed nor intended for use in a life support device or system, nor for use in other fault-intolerant, hazardous or other environments requiring fail-safe performance, such as any application in which the failure or malfunction of the product could lead directly or indirectly to death, bodily injury, or physical or property damage (collectively, “high-risk environments”).

 u-blox expressly disclaims any express or implied warranty of fitness for use in high-risk environments.

The customer using this product in a high-risk environment agrees to indemnify and defend u-blox from and against any claims and damages arising out of such use.

Related Documents

- [1] u-blox Package Information Guide, doc. no. [UBX-14001652](#)
- [2] Nordic Semiconductor, [nRF52840 Product Specification](#)
- [3] Nordic Semiconductor, [nRF5 Software Development Kit](#)

 For regular updates to u-blox documentation and to receive product change notifications, register on our homepage (www.u-blox.com).

Revision history

Revision	Date	Name	Comments
0.8	05-Jul-2017	brec	Initial release.
1.0	21-May-2018	brec	Production release. Updated power specifications. Added details on REG0 related silicon errata. Updated certification information. Added Zigbee information. Removed outdated factory firmware information.
1.1	24-Jul-2018		Added Antenna data and updated certification information.
2.0	01-Feb-2019	brec	Updated to new format Updated Life Support and other High-Risk Use Warning
2.1	28-Feb-2019	brec	Corrected output power in Table 7 to +8 dBm Corrected superscript note on low frequency GPIO pins
2.2	10-May-2019	brec	Added reference to S340 SoftDevice Updated Nordic Semiconductor links Updated HV power output specifications Updated RC Oscillator specifications
R07	21-Oct-2019	brec, kgom	Document converted from Rigado to u-blox style data sheet. Changed packing and shipping carton labeling in Section 11
R08	07-Jan-2020	brec	Edits for consistency with other BMD-3 modules; Added information about Nordic Semiconductor errata related to the DCDC configuration, which are solved in BMD-340-A-R-01 and newer (section 3.3)
R09	26-Mar-2020	brec	Added type number BMD-340-A-R-10; Added u-blox logo to Figure 11 to show orientation of label; Added label information for new type number in section 5.3; Added ESD precautions in section 10.4; Changed images to be u-blox branded; Added packaging specification for type number BMD-340-A-R-10 in section 10.1; Updated antenna patterns to show both horizontal and vertical plots.
R10	27-Apr-2020	brec	Removed remark pin 51 in Table 2: no restriction on pin use for P1.08, clarified PWM feature, updated block diagram (Figure 1), minor typographical corrections
R11	08-Jun-2020	brec	Added Japan (MIC) certification in Table 1 and section 8.5, moved Bluetooth declaration to section 8.6

Contact

For complete contact information, visit us at www.u-blox.com.

u-blox Offices

North, Central and South America

u-blox America, Inc.

Phone: +1 703 483 3180
E-mail: info_us@u-blox.com

Regional Office West Coast:

Phone: +1 408 573 3640
E-mail: info_us@u-blox.com

Technical Support:

Phone: +1 703 483 3185
E-mail: support@u-blox.com

Headquarters

Europe, Middle East, Africa

u-blox AG

Phone: +41 44 722 74 44
E-mail: info@u-blox.com
Support: support@u-blox.com

Asia, Australia, Pacific

u-blox Singapore Pte. Ltd.

Phone: +65 6734 3811
E-mail: info_ap@u-blox.com
Support: support_ap@u-blox.com

Regional Office Australia:

Phone: +61 2 8448 2016
E-mail: info_anz@u-blox.com
Support: support_ap@u-blox.com

Regional Office China (Beijing):

Phone: +86 10 68 133 545
E-mail: info_cn@u-blox.com
Support: support_cn@u-blox.com

Regional Office China (Chongqing):

Phone: +86 23 6815 1588
E-mail: info_cn@u-blox.com
Support: support_cn@u-blox.com

Regional Office China (Shanghai):

Phone: +86 21 6090 4832
E-mail: info_cn@u-blox.com
Support: support_cn@u-blox.com

Regional Office China (Shenzhen):

Phone: +86 755 8627 1083
E-mail: info_cn@u-blox.com
Support: support_cn@u-blox.com

Regional Office India:

Phone: +91 80 405 092 00
E-mail: info_in@u-blox.com
Support: support_in@u-blox.com

Regional Office Japan (Osaka):

Phone: +81 6 6941 3660
E-mail: info_jp@u-blox.com
Support: support_jp@u-blox.com

Regional Office Japan (Tokyo):

Phone: +81 3 5775 3850
E-mail: info_jp@u-blox.com
Support: support_jp@u-blox.com

Regional Office Korea:

Phone: +82 2 542 0861
E-mail: info_kr@u-blox.com
Support: support_kr@u-blox.com

Regional Office Taiwan:

Phone: +886 2 2657 1090
E-mail: info_tw@u-blox.com
Support: support_tw@u-blox.com