

**Data sheet | Item number: 2002-7214**

2-conductor N-disconnect terminal block; 2.5 mm<sup>2</sup>; Push-in CAGE CLAMP®;  
2,50 mm<sup>2</sup>; blue

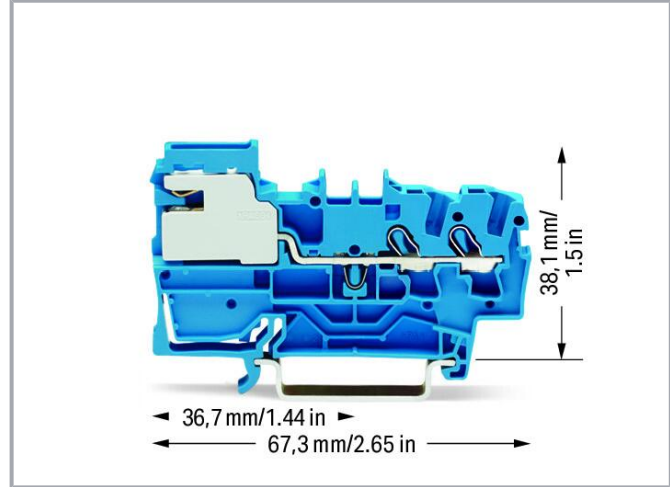

[www.wago.com/2002-7214](http://www.wago.com/2002-7214)

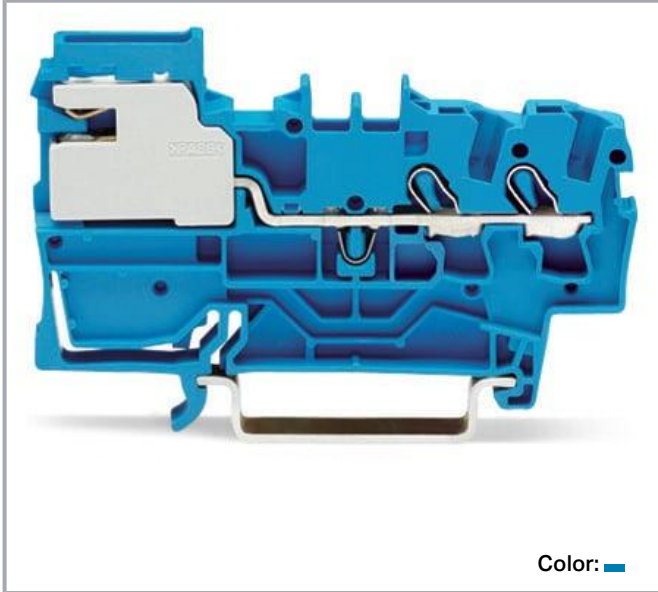

Color: ■

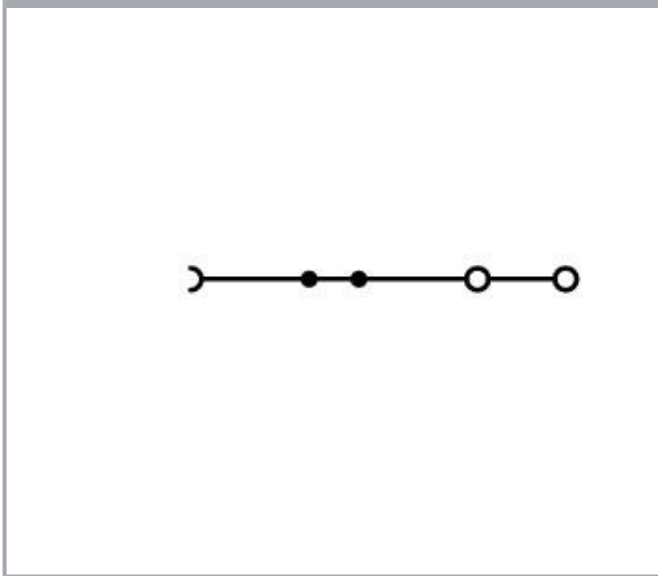

**Data**  
**Electrical data**

Subject to changes. Please also observe the further product documentation!

WAGO GmbH & Co. KG  
Hansastr. 27  
32423 Minden  
Phone: +49571 887-0 | Fax: +49571 887-169  
Email: [info.de@wago.com](mailto:info.de@wago.com) | Web: [www.wago.com](http://www.wago.com)

Do you have any questions about our products?  
We are always happy to take your call at +49 (571) 887-44222.



## Ratings per IEC/EN

Ratings per	IEC/EN 60947-7-1
Nominal voltage (III/3)	250 V
Rated impulse voltage (III/3)	4 kV
Rated current	32 A
Legend (ratings)	(III / 3) $\hat{=}$ Overvoltage category III / Pollution degree 3

## Power loss

Power loss, per pole (potential)	1.362 W
Rated current $I_N$ for specified power loss	32 A
Resistance value for specified, current-dependent power loss	0.001 $\Omega$

## Connection data

Connection points	2
Total number of potentials	1
Number of levels	1
Number of jumper slots	2

## Connection 1

Connection technology	Push-in CAGE CLAMP <sup>®</sup>
Actuation type	Operating tool
Connectable conductor materials	Copper
Nominal cross-section	2.5 mm <sup>2</sup>
Solid conductor	0.25 ... 4 mm <sup>2</sup> / 22 ... 12 AWG
Solid conductor; push-in termination	0.75 ... 4 mm <sup>2</sup> / 18 ... 12 AWG
Fine-stranded conductor	0.25 ... 4 mm <sup>2</sup> / 22 ... 12 AWG
Fine-stranded conductor; with insulated ferrule	0.25 ... 2.5 mm <sup>2</sup> / 22 ... 14 AWG
Fine-stranded conductor; with ferrule; push-in termination	1 ... 2.5 mm <sup>2</sup> / 18 ... 14 AWG
Note (conductor cross-section)	Depending on the conductor characteristic, a conductor with a smaller cross-section can also be inserted via push-in termination.
Strip length	10 ... 12 mm / 0.39 ... 0.47 inches
Wiring direction	Front-entry wiring

Subject to changes. Please also observe the further product documentation!



## Physical data

Width	5.2 mm / 0.205 inches
Height	67.3 mm / 2.65 inches
Depth from upper-edge of DIN-rail	38.1 mm / 1.5 inches

## Mechanical Data

Mounting type	DIN-35 rail
Marking level	Center/side marking

## Material Data

Note (material data)	Information on material specifications can be found here
Color	blue
Material group	I
Insulation material	Polyamide (PA66)
Flammability class per UL94	V0
Fire load	0.19 MJ
Weight	10.2 g

## Environmental requirements

Processing temperature	-35 ... +85 °C
Continuous operating temperature	-60 ... +105 °C

## Commercial data

Product Group	22 (TOPJOB S)
eCl@ss 10.0	27-14-11-38
eCl@ss 9.0	27-14-11-38
ETIM 8.0	EC001257
ETIM 7.0	EC001257
PU (SPU)	50 pcs
Packaging type	box
Country of origin	PL
GTIN	4045454802295
Customs tariff number	85365080900

Subject to changes. Please also observe the further product documentation!

WAGO GmbH & Co. KG  
Hansastr. 27  
32423 Minden  
Phone: +49571 887-0 | Fax: +49571 887-169  
Email: [info.de@wago.com](mailto:info.de@wago.com) | Web: [www.wago.com](http://www.wago.com)

Do you have any questions about our products?  
We are always happy to take your call at +49 (571) 887-44222.



## Environmental Product Compliance

RoHS Compliance Status



Compliant, No Exemption

## Approvals / Certificates



### General approvals

Logo	Approval	Additional Approval Text	Certificate name
	CCA DEKRA Certification B.V.	EN 60947	71-120369
	CCA DEKRA Certification B.V.	EN 60947	NTR NL 7892

### Declarations of conformity and manufacturer's declarations

Logo	Approval	Additional Approval Text	Certificate name
	EU-Declaration of Conformity WAGO GmbH & Co. KG	-	-
	UK-Declaration of Conformity WAGO GmbH & Co. KG	-	-

### Approvals for marine applications

Logo	Approval	Additional Approval Text	Certificate name
	ABS American Bureau of Shipping	EN 60947	20-HG1941090-PDA
	DNV GL Det Norske Veritas, Germanischer Lloyd	-	TAE00001V2

Subject to changes. Please also observe the further product documentation!

WAGO GmbH & Co. KG  
 Hansastr. 27  
 32423 Minden  
 Phone: +49571 887-0 | Fax: +49571 887-169  
 Email: [info.de@wago.com](mailto:info.de@wago.com) | Web: [www.wago.com](http://www.wago.com)

Do you have any questions about our products?  
 We are always happy to take your call at +49 (571) 887-44222.

## Required accessories

### End plate

End plate



**Item no.: 2002-7292**

End and intermediate plate; 0.8 mm thick; orange

[www.wago.com/2002-7292](http://www.wago.com/2002-7292)

## Optional accessories

### Lock-out

Locking system



**Item no.: 2005-7300**

Lock-out; prevents reclosing of slide link; Snap-in type; for 2002 and 2005 Series; orange

[www.wago.com/2005-7300](http://www.wago.com/2005-7300)

### Tool

Operating tool



**Item no.: 210-658**

Operating tool; Blade: 3.5 x 0.5 mm; with a partially insulated shaft; angled; short; multicoloured

[www.wago.com/210-658](http://www.wago.com/210-658)



**Item no.: 210-720**

Operating tool; Blade: 3.5 x 0.5 mm; with a partially insulated shaft; multicoloured

[www.wago.com/210-720](http://www.wago.com/210-720)

## Testing and measuring

Testing accessories



**Item no.: 2002-511**

Modular TOPJOB®S connector; modular; for jumper contact slot; 1-pole; 2,50 mm<sup>2</sup>; gray

[www.wago.com/2002-511](http://www.wago.com/2002-511)



**Item no.: 2002-549**

Spacer module; modular; e.g., for bridging commoned terminal blocks; gray

[www.wago.com/2002-549](http://www.wago.com/2002-549)



**Item no.: 2002-611**

TOPJOB®S L-type test plug module; modular; 1-pole; 2,50 mm<sup>2</sup>; gray

[www.wago.com/2002-611](http://www.wago.com/2002-611)



**Item no.: 2002-649**

TOPJOB®S L-type spacer module; modular; e.g., for bridging commoned terminal blocks; gray

[www.wago.com/2002-649](http://www.wago.com/2002-649)

## Mounting

Cover carrier



**Item no.: 709-169**

Cover carrier; Type 3; gray

[www.wago.com/709-169](http://www.wago.com/709-169)

Cover

Subject to changes. Please also observe the further product documentation!

WAGO GmbH & Co. KG

Hansastr. 27

32423 Minden

Phone: +49571 887-0 | Fax: +49571 887-169

Email: [info.de@wago.com](mailto:info.de@wago.com) | Web: [www.wago.com](http://www.wago.com)

Do you have any questions about our products?

We are always happy to take your call at +49 (571) 887-44222.



**Item no.: 709-156**  
Cover; Type 3; suitable for cover carrier, type 3; 1 m long; transparent

[www.wago.com/709-156](http://www.wago.com/709-156)

Mounting accessories



**Item no.: 2009-305**  
Busbar carrier; with end stop function and detachable separator plate; for DIN 35 rail; 7.5 mm thick; blue

[www.wago.com/2009-305](http://www.wago.com/2009-305)



**Item no.: 2009-304**  
Busbar carrier; not suitable for use as end stop; for DIN 35 rail; 1.5 mm thick; blue

[www.wago.com/2009-304](http://www.wago.com/2009-304)

**N-busbar**

Mounting accessories



**Item no.: 210-133**  
Busbar; tin-plated; 1000 mm long; Cu 10 mm x 3 mm; white

[www.wago.com/210-133](http://www.wago.com/210-133)

**Insulation stop**

Insulation stop



**Item no.: 2002-171**  
Insulation stop; 0.25 - 0.5 mm<sup>2</sup>; 5 pieces/strip; light gray

[www.wago.com/2002-171](http://www.wago.com/2002-171)



**Item no.: 2002-172**  
Insulation stop; 0.75 - 1 mm<sup>2</sup>; 5 pieces/strip; dark gray

[www.wago.com/2002-172](http://www.wago.com/2002-172)

**Carrier rail**

Mounting accessories



**Item no.: 210-197**  
Steel carrier rail; 35 x 15 mm; 1.5 mm thick; 2 m long; slotted; similar to EN 60715; silver-colored

[www.wago.com/210-197](http://www.wago.com/210-197)



**Item no.: 210-198**  
Copper carrier rail; 35 x 15 mm; 2.3 mm thick; 2 m long; unslotted; according to EN 60715; copper-colored

[www.wago.com/210-198](http://www.wago.com/210-198)



**Item no.: 210-504**  
Steel carrier rail; 35 x 7.5 mm; 1 mm thick; 2 m long; slotted; galvanized; according to EN 60715; silver-colored

[www.wago.com/210-504](http://www.wago.com/210-504)



**Item no.: 210-505**  
Steel carrier rail; 35 x 7.5 mm; 1 mm thick; 2 m long; unslotted; galvanized; according to EN 60715; silver-colored

[www.wago.com/210-505](http://www.wago.com/210-505)

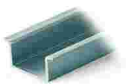

**Item no.: 210-506**  
Steel carrier rail; 35 x 15 mm; 1.5 mm thick; 2 m long; unslotted; galvanized; similar to EN 60715; silver-colored

[www.wago.com/210-506](http://www.wago.com/210-506)



**Item no.: 210-508**  
Steel carrier rail; 35 x 15 mm; 1.5 mm thick; 2 m long; slotted; galvanized; similar to EN 60715; silver-colored

[www.wago.com/210-508](http://www.wago.com/210-508)



**Item no.: 210-113**  
Steel carrier rail; 35 x 7.5 mm; 1 mm thick; 2 m long; unslotted; according to EN 60715; silver-colored

[www.wago.com/210-113](http://www.wago.com/210-113)

Subject to changes. Please also observe the further product documentation!

**Item no.: 210-118**

Steel carrier rail; 35 x 15 mm; 2.3 mm thick; 2 m long; unslotted; according to EN 60715; silver-colored

[www.wago.com/210-118](http://www.wago.com/210-118)**Item no.: 210-112**

Steel carrier rail; 35 x 7.5 mm; 1 mm thick; 2 m long; slotted; according to EN 60715; "Hole width 25 mm; silver-colored

[www.wago.com/210-112](http://www.wago.com/210-112)**Item no.: 210-114**

Steel carrier rail; 35 x 15 mm; 1.5 mm thick; 2 m long; unslotted; similar to EN 60715; silver-colored

[www.wago.com/210-114](http://www.wago.com/210-114)**Item no.: 210-115**

Steel carrier rail; 35 x 7.5 mm; 1 mm thick; 2 m long; slotted; according to EN 60715; "Hole width 18 mm; silver-colored

[www.wago.com/210-115](http://www.wago.com/210-115)**Item no.: 210-196**

Aluminum carrier rail; 35 x 8.2 mm; 1.6 mm thick; 2 m long; unslotted; similar to EN 60715; silver-colored

[www.wago.com/210-196](http://www.wago.com/210-196)**Ferrule**

## Ferrule

**Item no.: 216-241**Ferrule; Sleeve for 0.5 mm<sup>2</sup> / 20 AWG; insulated; electro-tin plated; electrolytic copper; gastight crimped; acc. to DIN 46228, Part 4/09.90; white[www.wago.com/216-241](http://www.wago.com/216-241)**Item no.: 216-242**Ferrule; Sleeve for 0.75 mm<sup>2</sup> / 18 AWG; insulated; electro-tin plated; electrolytic copper; gastight crimped; acc. to DIN 46228, Part 4/09.90; gray[www.wago.com/216-242](http://www.wago.com/216-242)**Item no.: 216-243**Ferrule; Sleeve for 1 mm<sup>2</sup> / AWG 18; insulated; electro-tin plated; electrolytic copper; gastight crimped; acc. to DIN 46228, Part 4/09.90; red[www.wago.com/216-243](http://www.wago.com/216-243)**Item no.: 216-244**Ferrule; Sleeve for 1.5 mm<sup>2</sup> / AWG 16; insulated; electro-tin plated; electrolytic copper; gastight crimped; acc. to DIN 46228, Part 4/09.90; black[www.wago.com/216-244](http://www.wago.com/216-244)**Item no.: 216-263**Ferrule; Sleeve for 1 mm<sup>2</sup> / AWG 18; insulated; electro-tin plated; electrolytic copper; gastight crimped; acc. to DIN 46228, Part 4/09.90; red[www.wago.com/216-263](http://www.wago.com/216-263)**Item no.: 216-246**Ferrule; Sleeve for 2.5 mm<sup>2</sup> / AWG 14; insulated; electro-tin plated; electrolytic copper; gastight crimped; acc. to DIN 46228, Part 4/09.90; blue[www.wago.com/216-246](http://www.wago.com/216-246)**Item no.: 216-266**Ferrule; Sleeve for 2.5 mm<sup>2</sup> / AWG 14; insulated; electro-tin plated; electrolytic copper; gastight crimped; acc. to DIN 46228, Part 4/09.90; blue[www.wago.com/216-266](http://www.wago.com/216-266)**Item no.: 216-264**Ferrule; Sleeve for 1.5 mm<sup>2</sup> / AWG 16; insulated; electro-tin plated; electrolytic copper; gastight crimped; acc. to DIN 46228, Part 4/09.90; black[www.wago.com/216-264](http://www.wago.com/216-264)**Item no.: 216-262**Ferrule; Sleeve for 0.75 mm<sup>2</sup> / 18 AWG; insulated; electro-tin plated; electrolytic copper; gastight crimped; acc. to DIN 46228, Part 4/09.90; gray[www.wago.com/216-262](http://www.wago.com/216-262)**Jumpers**

## Jumper

Subject to changes. Please also observe the further product documentation!

WAGO GmbH &amp; Co. KG

Hansastr. 27















32423 Minden

Phone: +49571 887-0 | Fax: +49571 887-169

Email: [info.de@wago.com](mailto:info.de@wago.com) | Web: [www.wago.com](http://www.wago.com)

Do you have any questions about our products?

We are always happy to take your call at +49 (571) 887-44222.

	<b>Item no.: 2002-402</b> Jumper; 2-way; insulated; light gray	<a href="http://www.wago.com/2002-402">www.wago.com/2002-402</a>
	<b>Item no.: 2002-402/000-005</b> Jumper; 2-way; insulated; red	<a href="http://www.wago.com/2002-402/000-005">www.wago.com/2002-402/000-005</a>
	<b>Item no.: 2002-400</b> Continuous jumper; 2-way; insulated; light gray	<a href="http://www.wago.com/2002-400">www.wago.com/2002-400</a>
	<b>Item no.: 2002-403</b> Jumper; 3-way; insulated; light gray	<a href="http://www.wago.com/2002-403">www.wago.com/2002-403</a>
	<b>Item no.: 2002-404/000-005</b> Jumper; 4-way; insulated; red	<a href="http://www.wago.com/2002-404/000-005">www.wago.com/2002-404/000-005</a>
	<b>Item no.: 2002-403/000-006</b> Jumper; 3-way; insulated; blue	<a href="http://www.wago.com/2002-403/000-006">www.wago.com/2002-403/000-006</a>
	<b>Item no.: 2002-404/000-006</b> Jumper; 4-way; insulated; blue	<a href="http://www.wago.com/2002-404/000-006">www.wago.com/2002-404/000-006</a>
	<b>Item no.: 2002-403/000-005</b> Jumper; 3-way; insulated; red	<a href="http://www.wago.com/2002-403/000-005">www.wago.com/2002-403/000-005</a>
	<b>Item no.: 2002-405/000-005</b> Jumper; 5-way; insulated; red	<a href="http://www.wago.com/2002-405/000-005">www.wago.com/2002-405/000-005</a>
	<b>Item no.: 2002-402/000-006</b> Jumper; 2-way; insulated; blue	<a href="http://www.wago.com/2002-402/000-006">www.wago.com/2002-402/000-006</a>
	<b>Item no.: 2002-405/000-006</b> Jumper; 5-way; insulated; blue	<a href="http://www.wago.com/2002-405/000-006">www.wago.com/2002-405/000-006</a>
	<b>Item no.: 2002-404</b> Jumper; 4-way; insulated; light gray	<a href="http://www.wago.com/2002-404">www.wago.com/2002-404</a>
	<b>Item no.: 2002-406/000-006</b> Jumper; 6-way; insulated; blue	<a href="http://www.wago.com/2002-406/000-006">www.wago.com/2002-406/000-006</a>
	<b>Item no.: 2002-406/000-005</b> Jumper; 6-way; insulated; red	<a href="http://www.wago.com/2002-406/000-005">www.wago.com/2002-406/000-005</a>

Subject to changes. Please also observe the further product documentation!





**Item no.: 2002-406/020-000**  
Delta jumper; insulated; light gray

[www.wago.com/2002-406/020-000](http://www.wago.com/2002-406/020-000)



**Item no.: 2002-405**  
Jumper; 5-way; insulated; light gray

[www.wago.com/2002-405](http://www.wago.com/2002-405)



**Item no.: 2002-407/000-005**  
Jumper; 7-way; insulated; red

[www.wago.com/2002-407/000-005](http://www.wago.com/2002-407/000-005)



**Item no.: 2002-408**  
Jumper; 8-way; insulated; light gray

[www.wago.com/2002-408](http://www.wago.com/2002-408)



**Item no.: 2002-408/000-006**  
Jumper; 8-way; insulated; blue

[www.wago.com/2002-408/000-006](http://www.wago.com/2002-408/000-006)



**Item no.: 2002-405/011-000**  
Star point jumper; 3-way; insulated; light gray

[www.wago.com/2002-405/011-000](http://www.wago.com/2002-405/011-000)



**Item no.: 2002-407/000-006**  
Jumper; 7-way; insulated; blue

[www.wago.com/2002-407/000-006](http://www.wago.com/2002-407/000-006)



**Item no.: 2002-408/000-005**  
Jumper; 8-way; insulated; red

[www.wago.com/2002-408/000-005](http://www.wago.com/2002-408/000-005)



**Item no.: 2002-407**  
Jumper; 7-way; insulated; light gray

[www.wago.com/2002-407](http://www.wago.com/2002-407)



**Item no.: 2002-406**  
Jumper; 6-way; insulated; light gray

[www.wago.com/2002-406](http://www.wago.com/2002-406)



**Item no.: 2002-410/000-005**  
Jumper; 10-way; insulated; red

[www.wago.com/2002-410/000-005](http://www.wago.com/2002-410/000-005)



**Item no.: 2002-410/000-006**  
Jumper; 10-way; insulated; blue

[www.wago.com/2002-410/000-006](http://www.wago.com/2002-410/000-006)

Subject to changes. Please also observe the further product documentation!



**Item no.: 2002-410**  
Jumper; 10-way; insulated; light gray

[www.wago.com/2002-410](http://www.wago.com/2002-410)



**Item no.: 2002-409/000-006**  
Jumper; 9-way; insulated; blue

[www.wago.com/2002-409/000-006](http://www.wago.com/2002-409/000-006)



**Item no.: 2002-409/000-005**  
Jumper; 9-way; insulated; red

[www.wago.com/2002-409/000-005](http://www.wago.com/2002-409/000-005)



**Item no.: 2002-409**  
Jumper; 9-way; insulated; light gray

[www.wago.com/2002-409](http://www.wago.com/2002-409)



**Item no.: 2002-423/000-006**  
Continuous jumper; from 1 to 3; insulated; blue

[www.wago.com/2002-423/000-006](http://www.wago.com/2002-423/000-006)



**Item no.: 2002-423**  
Continuous jumper; from 1 to 3; insulated; light gray

[www.wago.com/2002-423](http://www.wago.com/2002-423)



**Item no.: 2002-433**  
Jumper; from 1 to 3; insulated; light gray

[www.wago.com/2002-433](http://www.wago.com/2002-433)



**Item no.: 2002-434**  
Jumper; from 1 to 4; insulated; light gray

[www.wago.com/2002-434](http://www.wago.com/2002-434)



**Item no.: 2002-423/000-005**  
Continuous jumper; from 1 to 3; insulated; red

[www.wago.com/2002-423/000-005](http://www.wago.com/2002-423/000-005)



**Item no.: 2002-435**  
Jumper; from 1 to 5; insulated; light gray

[www.wago.com/2002-435](http://www.wago.com/2002-435)



**Item no.: 2002-436**  
Jumper; from 1 to 6; insulated; light gray

[www.wago.com/2002-436](http://www.wago.com/2002-436)



**Item no.: 2002-437**  
Jumper; from 1 to 7; insulated; light gray

[www.wago.com/2002-437](http://www.wago.com/2002-437)



**Item no.: 2002-438**  
Jumper; from 1 to 8; insulated; light gray

[www.wago.com/2002-438](http://www.wago.com/2002-438)



**Item no.: 2002-439**  
Jumper; from 1 to 9; insulated; light gray

[www.wago.com/2002-439](http://www.wago.com/2002-439)



**Item no.: 2002-440**  
Jumper; from 1 to 10; insulated; light gray

[www.wago.com/2002-440](http://www.wago.com/2002-440)



**Item no.: 2002-472**

[www.wago.com/2002-472](http://www.wago.com/2002-472)

Subject to changes. Please also observe the further product documentation!

Staggered jumper; 2-way; insulated; light gray



**Item no.: 2002-473**

Staggered jumper; 3-way; insulated; light gray

[www.wago.com/2002-473](http://www.wago.com/2002-473)



**Item no.: 2002-475/011-000**

Staggered jumper; 3-way; insulated; light gray

[www.wago.com/2002-475/011-000](http://www.wago.com/2002-475/011-000)



**Item no.: 2002-475**

Staggered jumper; 5-way; insulated; light gray

[www.wago.com/2002-475](http://www.wago.com/2002-475)



**Item no.: 2002-476**

Staggered jumper; 6-way; insulated; light gray

[www.wago.com/2002-476](http://www.wago.com/2002-476)



**Item no.: 2002-474**

Staggered jumper; 4-way; insulated; light gray

[www.wago.com/2002-474](http://www.wago.com/2002-474)



**Item no.: 2002-477**

Staggered jumper; 7-way; insulated; light gray

[www.wago.com/2002-477](http://www.wago.com/2002-477)



**Item no.: 2002-473/011-000**

Staggered jumper; 2-way; from 1 to 3; insulated; light gray

[www.wago.com/2002-473/011-000](http://www.wago.com/2002-473/011-000)



**Item no.: 2002-479**

Staggered jumper; 9-way; insulated; light gray

[www.wago.com/2002-479](http://www.wago.com/2002-479)



**Item no.: 2002-478**

Staggered jumper; 8-way; insulated; light gray

[www.wago.com/2002-478](http://www.wago.com/2002-478)



**Item no.: 2002-479/011-000**

Staggered jumper; insulated; light gray

[www.wago.com/2002-479/011-000](http://www.wago.com/2002-479/011-000)



**Item no.: 2002-480**

Staggered jumper; 10-way; insulated; light gray

[www.wago.com/2002-480](http://www.wago.com/2002-480)



**Item no.: 2002-477/011-000**

Staggered jumper; insulated; light gray

[www.wago.com/2002-477/011-000](http://www.wago.com/2002-477/011-000)



**Item no.: 2002-481/011-000**

Staggered jumper; insulated; light gray

[www.wago.com/2002-481/011-000](http://www.wago.com/2002-481/011-000)



**Item no.: 2002-481**

Staggered jumper; 11-way; insulated; light gray

[www.wago.com/2002-481](http://www.wago.com/2002-481)



**Item no.: 2002-482**

Staggered jumper; 12-way; insulated; light gray

[www.wago.com/2002-482](http://www.wago.com/2002-482)

Subject to changes. Please also observe the further product documentation!

WAGO GmbH & Co. KG

Hansastr. 27

32423 Minden

Phone: +49571 887-0 | Fax: +49571 887-169

Email: [info.de@wago.com](mailto:info.de@wago.com) | Web: [www.wago.com](http://www.wago.com)

Do you have any questions about our products?

We are always happy to take your call at +49 (571) 887-44222.



**Item no.: 2002-424/000-006**  
Continuous jumper; from 1 to 4; insulated; blue

[www.wago.com/2002-424/000-006](http://www.wago.com/2002-424/000-006)

### Marking accessories

#### Marking strip



**Item no.: 2009-110**  
Marking strips; for Smart Printer; on reel; not stretchable; plain; snap-on type; white

[www.wago.com/2009-110](http://www.wago.com/2009-110)

#### Marker carrier



**Item no.: 2009-198**  
Adaptor; gray

[www.wago.com/2009-198](http://www.wago.com/2009-198)



**Item no.: 2002-161**  
Adaptor; gray

[www.wago.com/2002-161](http://www.wago.com/2002-161)

#### Marker



**Item no.: 2009-115/000-002**  
WMB-Inline; for Smart Printer; 1500 pieces on roll; stretchable 5 - 5.2 mm; plain; snap-on type; yellow

[www.wago.com/2009-115/000-002](http://www.wago.com/2009-115/000-002)



**Item no.: 2009-115/000-007**  
WMB-Inline; for Smart Printer; 1500 pieces on roll; stretchable 5 - 5.2 mm; plain; snap-on type; gray

[www.wago.com/2009-115/000-007](http://www.wago.com/2009-115/000-007)



**Item no.: 2009-115/000-017**  
WMB-Inline; for Smart Printer; 1500 pieces on roll; stretchable 5 - 5.2 mm; plain; snap-on type; light green

[www.wago.com/2009-115/000-017](http://www.wago.com/2009-115/000-017)



**Item no.: 2009-115/000-023**  
WMB-Inline; for Smart Printer; 1500 pieces on roll; stretchable 5 - 5.2 mm; plain; snap-on type; green

[www.wago.com/2009-115/000-023](http://www.wago.com/2009-115/000-023)



**Item no.: 2009-115/000-024**  
WMB-Inline; for Smart Printer; 1500 pieces on roll; stretchable 5 - 5.2 mm; plain; snap-on type; violet

[www.wago.com/2009-115/000-024](http://www.wago.com/2009-115/000-024)



**Item no.: 2009-145/000-006**  
Mini-WSB Inline; for Smart Printer; 1700 pieces on roll; stretchable 5 - 5.2 mm; plain; snap-on type; blue

[www.wago.com/2009-145/000-006](http://www.wago.com/2009-145/000-006)



**Item no.: 2009-145**  
Mini-WSB Inline; for Smart Printer; 1700 pieces on roll; stretchable 5 - 5.2 mm; plain; snap-on type; white













[www.wago.com/2009-145](http://www.wago.com/2009-145)



**Item no.: 2009-145/000-002**  
Mini-WSB Inline; for Smart Printer; 1700 pieces on roll; stretchable 5 - 5.2 mm; plain; snap-on type; yellow

[www.wago.com/2009-145/000-002](http://www.wago.com/2009-145/000-002)

Subject to changes. Please also observe the further product documentation!

	<p><b>Item no.: 2009-145/000-007</b>                  Mini-WSB Inline; for Smart Printer; 1700 pieces on roll; stretchable 5 - 5.2 mm; plain; snap-on type; gray</p>	<a href="http://www.wago.com/2009-145/000-007">www.wago.com/2009-145/000-007</a>
	<p><b>Item no.: 2009-145/000-005</b>                  Mini-WSB Inline; for Smart Printer; 1700 pieces on roll; stretchable 5 - 5.2 mm; plain; snap-on type; red</p>	<a href="http://www.wago.com/2009-145/000-005">www.wago.com/2009-145/000-005</a>
	<p><b>Item no.: 2009-145/000-012</b>                  Mini-WSB Inline; for Smart Printer; 1700 pieces on roll; stretchable 5 - 5.2 mm; plain; snap-on type; orange</p>	<a href="http://www.wago.com/2009-145/000-012">www.wago.com/2009-145/000-012</a>
	<p><b>Item no.: 2009-145/000-023</b>                  Mini-WSB Inline; for Smart Printer; 1700 pieces on roll; stretchable 5 - 5.2 mm; plain; snap-on type; green</p>	<a href="http://www.wago.com/2009-145/000-023">www.wago.com/2009-145/000-023</a>
	<p><b>Item no.: 2009-145/000-024</b>                  Mini-WSB Inline; for Smart Printer; 1700 pieces on roll; stretchable 5 - 5.2 mm; plain; snap-on type; violet</p>	<a href="http://www.wago.com/2009-145/000-024">www.wago.com/2009-145/000-024</a>
	<p><b>Item no.: 2009-115</b>                  WMB-Inline; for Smart Printer; 1500 pieces on roll; stretchable 5 - 5.2 mm; plain; snap-on type; white</p>	<a href="http://www.wago.com/2009-115">www.wago.com/2009-115</a>
	<p><b>Item no.: 248-501/000-006</b>                  Mini-WSB marking card; as card; not stretchable; plain; snap-on type; blue</p>	<a href="http://www.wago.com/248-501/000-006">www.wago.com/248-501/000-006</a>
	<p><b>Item no.: 248-501/000-007</b>                  Mini-WSB marking card; as card; not stretchable; plain; snap-on type; gray</p>	<a href="http://www.wago.com/248-501/000-007">www.wago.com/248-501/000-007</a>
	<p><b>Item no.: 248-501/000-002</b>                  Mini-WSB marking card; as card; not stretchable; plain; snap-on type; yellow</p>	<a href="http://www.wago.com/248-501/000-002">www.wago.com/248-501/000-002</a>
	<p><b>Item no.: 248-501/000-012</b>                  Mini-WSB marking card; as card; not stretchable; plain; snap-on type; orange</p>	<a href="http://www.wago.com/248-501/000-012">www.wago.com/248-501/000-012</a>
	<p><b>Item no.: 248-501</b>                  Mini-WSB marking card; as card; not stretchable; plain; snap-on type; white</p>	<a href="http://www.wago.com/248-501">www.wago.com/248-501</a>
	<p><b>Item no.: 248-501/000-017</b>                  Mini-WSB marking card; as card; not stretchable; plain; snap-on type; light green</p>	<a href="http://www.wago.com/248-501/000-017">www.wago.com/248-501/000-017</a>

Subject to changes. Please also observe the further product documentation!



**Item no.:** 248-501/000-005  
Mini-WSB marking card; as card; not stretchable; plain; snap-on type; red

[www.wago.com/248-501/000-005](http://www.wago.com/248-501/000-005)



**Item no.:** 248-501/000-024  
Mini-WSB marking card; as card; not stretchable; plain; snap-on type; violet

[www.wago.com/248-501/000-024](http://www.wago.com/248-501/000-024)

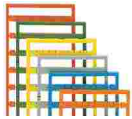

**Item no.:** 248-501/000-023  
Mini-WSB marking card; as card; not stretchable; plain; snap-on type; green

[www.wago.com/248-501/000-023](http://www.wago.com/248-501/000-023)



**Item no.:** 793-5501/000-007  
WMB marking card; as card; for terminal block width 5 - 17.5 mm; stretchable 5 - 5.2 mm; plain; snap-on type; gray

[www.wago.com/793-5501/000-007](http://www.wago.com/793-5501/000-007)



**Item no.:** 793-5501/000-012  
WMB marking card; as card; for terminal block width 5 - 17.5 mm; stretchable 5 - 5.2 mm; plain; snap-on type; orange

[www.wago.com/793-5501/000-012](http://www.wago.com/793-5501/000-012)



**Item no.:** 793-5501/000-014  
WMB marking card; as card; for terminal block width 5 - 17.5 mm; stretchable 5 - 5.2 mm; plain; snap-on type; brown

[www.wago.com/793-5501/000-014](http://www.wago.com/793-5501/000-014)



**Item no.:** 793-5501/000-017  
WMB marking card; as card; for terminal block width 5 - 17.5 mm; stretchable 5 - 5.2 mm; plain; snap-on type; light green

[www.wago.com/793-5501/000-017](http://www.wago.com/793-5501/000-017)



**Item no.:** 793-5501/000-023  
WMB marking card; as card; for terminal block width 5 - 17.5 mm; stretchable 5 - 5.2 mm; plain; snap-on type; green

[www.wago.com/793-5501/000-023](http://www.wago.com/793-5501/000-023)



**Item no.:** 793-5501/000-024  
WMB marking card; as card; for terminal block width 5 - 17.5 mm; stretchable 5 - 5.2 mm; plain; snap-on type; violet

[www.wago.com/793-5501/000-024](http://www.wago.com/793-5501/000-024)



**Item no.:** 793-5501/000-005  
WMB marking card; as card; for terminal block width 5 - 17.5 mm; stretchable 5 - 5.2 mm; plain; snap-on type; red

[www.wago.com/793-5501/000-005](http://www.wago.com/793-5501/000-005)

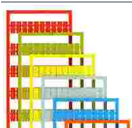

**Item no.:** 793-5501/000-002  
WMB marking card; as card; for terminal block width 5 - 17.5 mm; stretchable 5 - 5.2 mm; plain; snap-on type; yellow

[www.wago.com/793-5501/000-002](http://www.wago.com/793-5501/000-002)

Subject to changes. Please also observe the further product documentation!



**Item no.: 793-5501/000-006**

WMB marking card; as card; for terminal block width 5 - 17.5 mm; stretchable 5 - 5.2 mm; plain; snap-on type; blue [www.wago.com/793-5501/000-006](http://www.wago.com/793-5501/000-006)



**Item no.: 793-5501**

WMB marking card; as card; for terminal block width 5 - 17.5 mm; stretchable 5 - 5.2 mm; plain; snap-on type; white [www.wago.com/793-5501](http://www.wago.com/793-5501)



**Item no.: 2009-115/000-012**

WMB-Inline; for Smart Printer; 1500 pieces on roll; stretchable 5 - 5.2 mm; plain; snap-on type; orange [www.wago.com/2009-115/000-012](http://www.wago.com/2009-115/000-012)



**Item no.: 2009-115/000-006**

WMB-Inline; for Smart Printer; 1500 pieces on roll; stretchable 5 - 5.2 mm; plain; snap-on type; blue [www.wago.com/2009-115/000-006](http://www.wago.com/2009-115/000-006)



**Item no.: 2009-115/000-005**

WMB-Inline; for Smart Printer; 1500 pieces on roll; stretchable 5 - 5.2 mm; plain; snap-on type; red [www.wago.com/2009-115/000-005](http://www.wago.com/2009-115/000-005)

Group marker carrier



**Item no.: 2009-193**

Group marker carrier; gray [www.wago.com/2009-193](http://www.wago.com/2009-193)



**Item no.: 2009-192**

Group marker carrier; gray [www.wago.com/2009-192](http://www.wago.com/2009-192)



**Item no.: 2009-191**

Group marker carrier; gray [www.wago.com/2009-191](http://www.wago.com/2009-191)

**Downloads**

**Documentation**

**Bid Text**

2002-7214 X81 - Datei	2019 Apr 18	xml 3.9 kB	Download
2002-7214 docx - Datei	2019 Apr 18	docx 15.1 kB	Download

**Additional Information**

Technical Section Technical explanations	pdf 2.2 MB	Download
---	---------------	----------

**CAD/CAE-Data**

Subject to changes. Please also observe the further product documentation!

WAGO GmbH & Co. KG  
Hansastr. 27  
32423 Minden  
Phone: +49571 887-0 | Fax: +49571 887-169  
Email: [info.de@wago.com](mailto:info.de@wago.com) | Web: [www.wago.com](http://www.wago.com)

Do you have any questions about our products?  
We are always happy to take your call at +49 (571) 887-44222.

### CAE data

EPLAN Data Portal 2002-7214	<a href="#">URL</a>	<a href="#">Download</a>
WSCAD Universe 2002-7214	<a href="#">URL</a>	<a href="#">Download</a>
ZUKEN Portal 2002-7214	<a href="#">URL</a>	<a href="#">Download</a>

### CAD data

2D/3D Models 2002-7214	<a href="#">URL</a>	<a href="#">Download</a>
------------------------	---------------------	--------------------------

## Environmental Product Compliance

### Compliance Search

Environmental Product Compliance 2002-7214 2-conductor N-disconnect terminal block; 2.5 mm <sup>2</sup> ; Push-in CAGE CLAMP®; 2,50 mm <sup>2</sup> ; blue	<a href="#">URL</a>	<a href="#">Download</a>
---	---------------------	--------------------------

## Installation Notes

### Conductor termination

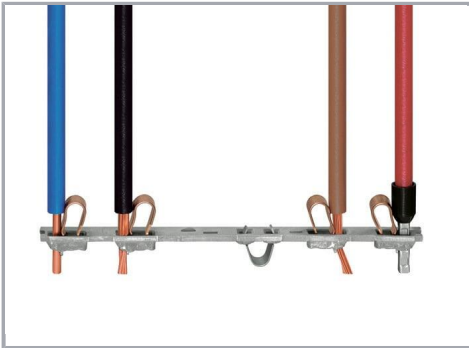

### All conductor types at a glance

### Busbar

Subject to changes. Please also observe the further product documentation!



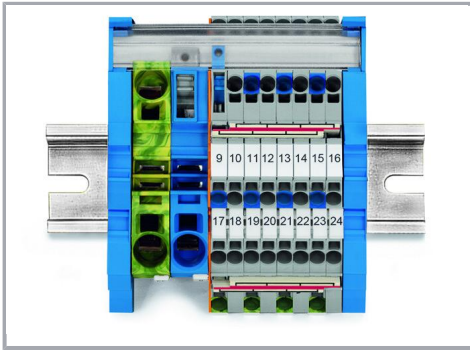

Mounting busbars on busbar carriers: Insert busbar ends onto large busbar carriers (2009-305) or onto supply terminal blocks with an integrated busbar carrier.

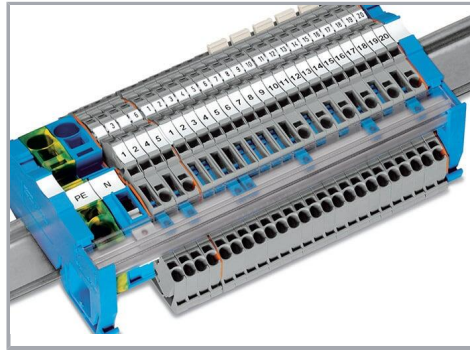

The busbar transparent cover (Item No. 777-303) protects the busbar against accidental contact and makes it easy to see which terminal blocks are connected to the busbar.

## Product family

### TOPJOB® S

TOPJOB® S: In various industrial applications and modern building installations, WAGO's wide and versatile range of rail-mount terminal blocks provides more than just reliable electrical connections.

[Show all products from the family](#)

Subject to changes. Please also observe the further product documentation!