

# 0RQB-D0W12L

## Isolated DC-DC Converter

The 0RQB-D0W12L is an isolated DC/DC converter that provide up to 200 W of output power from a wide input range (72 V, 96 V and 110 V typical).

The unit is designed to be highly efficient. Standard feature include remote on/off, input under-voltage lockout, over current and short circuit protection and overvoltage protection. Conformal coated PCB is used for environmental ruggedness.

### Key Features & Benefits

- 72/96/110 VDC Input / 12 VDC @ 16.7 A Output/1/4<sup>th</sup> Brick Converter
- Isolated
- Fixed Frequency
- High Efficiency
- Input Under Voltage Lockout
- Input Over Voltage Lockout
- OCP/SCP
- Output Over-voltage Protection
- Over Temperature Protection
- Approved to UL/CSA60950-1, 2nd +A2 version(TBD)
- Class II, Category 2, Isolated DC/DC Converter (refer to IPC-9592B)



### Applications

- Industrial
- Railways
- Telecommunications

## 1. MODEL SELECTION

MODEL NUMBER	OUTPUT VOLTAGE	INPUT VOLTAGE	MAX. OUTPUT CURRENT	MAX. OUTPUT POWER	TYPICAL EFFICIENCY
ORQB-D0W12L	12 VDC	72/96/110V VDC	16.7 A	200 W	93%

**NOTE:** Add "G" suffix at the end of the model number to indicate Tray Packaging.

### PART NUMBER EXPLANATION

0	R	QB	-	D0	W	12	L	x
Mounting Type	RoHS Status	Series Name		Output Power	Input Range	Output Voltage	Active Logic	Package Type
Through hole mount	RoHS	DOSA Quarter Brick		200 W	72/96/110V	12 V	Active low, without HSK	G – Tray package

## 2. ABSOLUTE MAXIMUM RATINGS

PARAMETER	DESCRIPTION	MIN	TYP	MAX	UNITS
Continuous non-operating Input Voltage		-0.5	-	164	V
Remote On/Off		-0.3	-	15	V
Current Sink		0	-	10	mA
Isolation voltage	Input to output	-	-	2250	V
Operating Temperature	Temperature measured at the center of the baseplate, full load	-40	-	95	°C
Thermal resistance		-	0.3	-	°C/W
Storage Temperature		-55	-	125	°C
Altitude		-	-	2000	m

**NOTE:** Ratings used beyond the maximum ratings may cause a reliability degradation of the converter or may permanently damage the device.

## 3. INPUT SPECIFICATIONS

All specifications are typical at 25°C unless otherwise stated.

PARAMETER	DESCRIPTION	MIN	TYP	MAX	UNIT
Operating Input Voltage 1	Fully functioning for long term operation.	50	-	137.5	V
Operating Input Voltage 2	Fully functioning for 100ms operation.	43	-	50	V
Operating Input Voltage 3	Fully functioning for 100ms operation. Full function is not guaranteed but undamaged for 1s operation.	137.5	-	156	V
Input Current (full load)		-	-	5.7	A
Input Current (no load)		-	50	-	mA
Remoted Off Input Current		-	2	5	mA
Input Reflected Ripple Current (rms)		-	20	-	mA
Input Reflected Ripple Current (pk-pk)		-	50	-	mA
Under-voltage Turn on Threshold	Turn on Threshold	46	47	49	V
Under-voltage Turn off Threshold	Turn off Threshold, non-latching	40	41	42.5	V
Over-voltage Shutdown Threshold	Auto-recovery and non-latching.	161	163	165	V
Over-voltage Recovery Threshold		154	155	156	V

#### 4. OUTPUT SPECIFICATIONS

All specifications are typical at nominal input, full load at 25°C unless otherwise stated.

PARAMETER	DESCRIPTION	MIN	TYP	MAX	UNIT
Output Voltage Set Point	Test condition of the output setpoint: $V_{in}=110V$ , $I_o=100\%$ load at 25°C ambient.	11.76	12	12.24	V
Load Regulation		-	-	±30	mV
Line Regulation		-	-	±30	mV
Regulation Over Temperature		-	±60	±200	mV
Ripple and Noise (pk-pk)	40KHz-100MHz BW, with 1µF ceramic capacitor and 220µF bulk electrolytic at output.	-	-	250	mV
Ripple and Noise (rms)		-	-	50	mV
Output Current Range		0	-	16.7	A
Output DC Current Limit	Enter a hiccup mode, non-latching.	18	20	22	A
Rise time	$V_{in}=110V$ , $I_o=16.7A$ , with 1µF ceramic capacitor and 220µF bulk electrolytic at output.	-	-	200	ms
Start-up time			300	500	ms
Overshoot at Turn on		-	0	3	%
Undershoot at Turn off		-	0	3	%
Output Capacitance		220	-	5000	µF
<b>Transient Response</b>					
ΔV 50%~75% Load		-	-	600	mV
Settling Time	$di/dt=0.1A/\mu s$ , with 1µF ceramic capacitor and 220µF bulk electrolytic at output.	-	-	2	ms
ΔV 75%~50% Load		-	-	600	mV
Settling Time		-	-	2	ms

#### 5. GENERAL SPECIFICATIONS

PARAMETER	DESCRIPTION	MIN	TYP	MAX	UNIT
Efficiency	$I_o=60\% I_{rate}$ – $100\% I_{rate}$ $I_o=40\% I_{rate}$ - $60\% I_{rate}$	92 90	93 92	- -	%
Switching Frequency		-	250	-	kHz
Output Voltage Trim Range		10.8	-	13.2	V
Over Temperature Protection	Temperature measured at the center of the baseplate, full load	-	110	-	°C
Output Over Voltage Protection	Enter a latching, non-hiccup mode	-	-	15	V
Weight		-	69	-	g
FIT	Calculated Per Bell Core SR-332 ( $V_{in}=110V$ , $V_o=12V$ , $I_o=13A$ , $T_a = 25^\circ C$ , $FIT=10^9/MTBF$ )	-	190.48	-	-
MTBF		-	5.25	-	Mhrs
Dimensions			2.45 x 1.45x 0.59		Inches
Inches (L x W x H)			62.24 x 36.84 x15		Millimeters
Millimeters (L x W x H)					
<b>Isolation Characteristics</b>					
Input to Output		-	-	2250	Vdc
Input to Heatsink		-	-	2250	Vdc
Output to Heatsink		-	-	2250	Vdc
Isolation Resistance		10M	-	-	Ohm
Isolation Capacitance		-	2200	-	pF

6. EFFICIENCY DATA

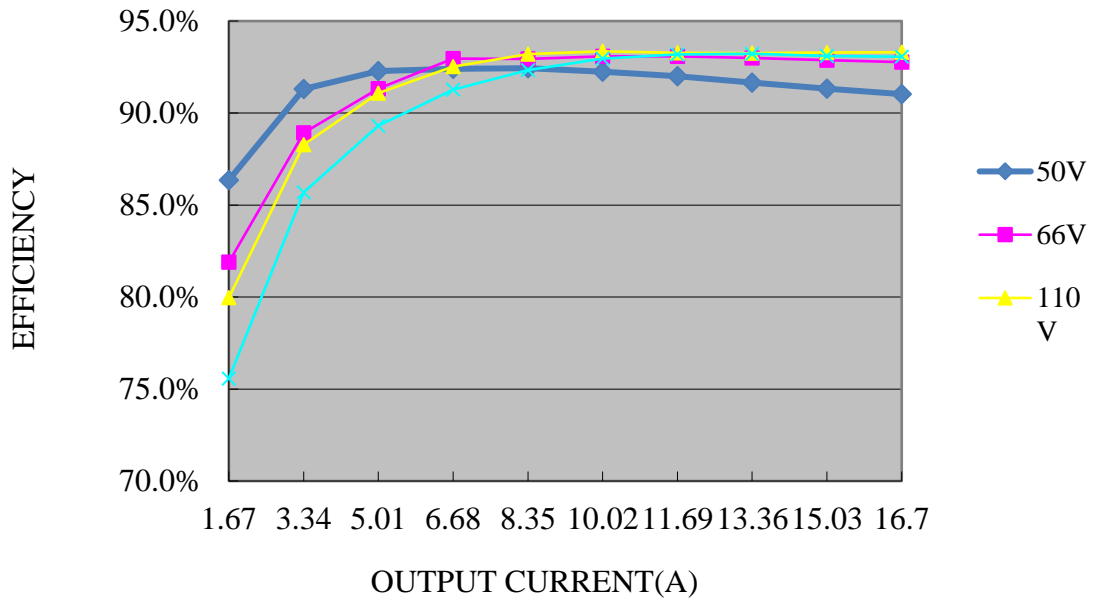

## 7. REMOVE ON/OFF

PARAMETER	DESCRIPTION	MIN	TYP	MAX	UNIT
Signal Low (Unit On)	Active Low Remote On/Off pin is open, the module is off	-0.3	-	0.8	V
Signal High (Unit Off)		2.4	-	18	V
Current Sink		0	-	1	mA

Recommended Remote On/Off Circuit for Active Low

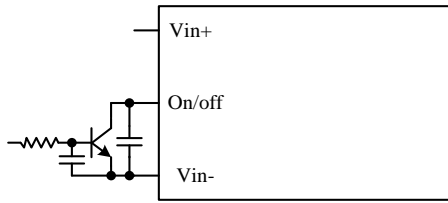

Control with open collector/drain circuit

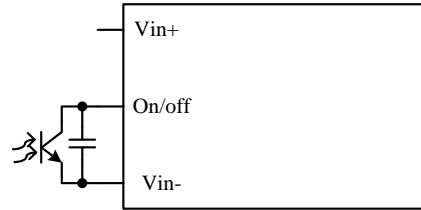

Control with photocoupler circuit

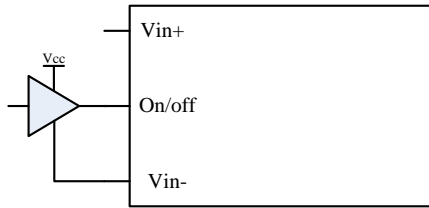

Control with logic circuit

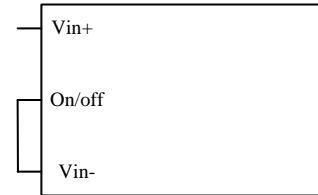

Permanently on

## 8. RIPPLE AND NOISE WAVEFORM

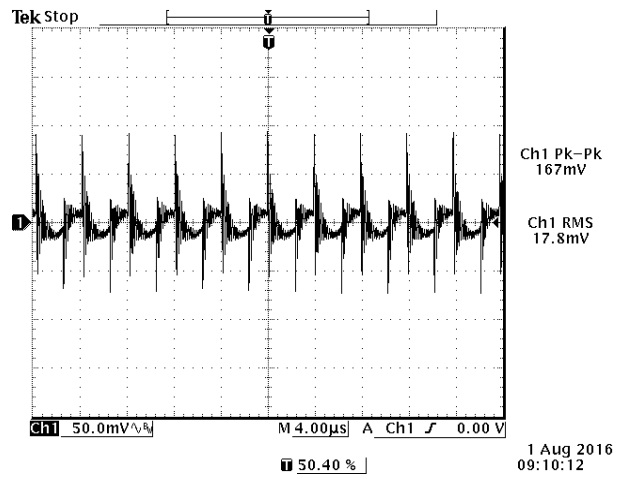

**Note:** Ripple and noise 110Vdc input, 12Vdc/16.7A output and  $T_a=25$  deg C, and with a 1µF ceramic cap and 220µF electrolytic cap at output.

## 9. THERMAL DERATING CURVES

1. In order to make it convenient for safety and test engineer, each curve has 3 air velocity at most. It is better that the middle one is at the center of minimum and maximum. For example, 0-200-400, 0-100-200, 100-200-300

2. If the minimum air velocity is 0LFM or 50LFM, do not mark on the curve, just record as "Natural Convection"

Maximum junction temperature of semiconductors derated to 115 degree C.

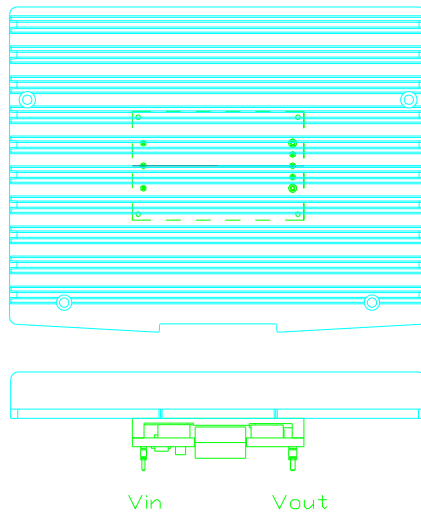

HSK Dimension:142x110x16mm (16 includes baseplate and ribs)

TA is the temperature on the large heatsink rib

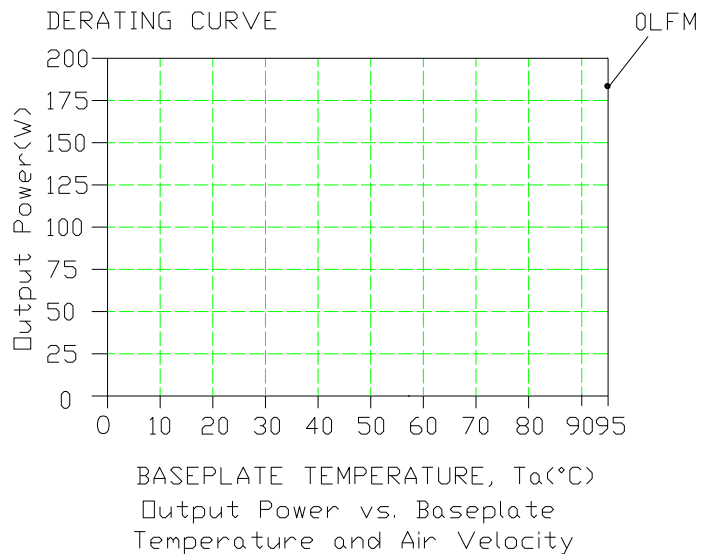

## 10. TRANSIENT RESPONSE WAVEFORMS

Transient Response:  $di/dt=0.1A/us$ , 1uF ceramic cap and 220uF electrolytic cap at output.

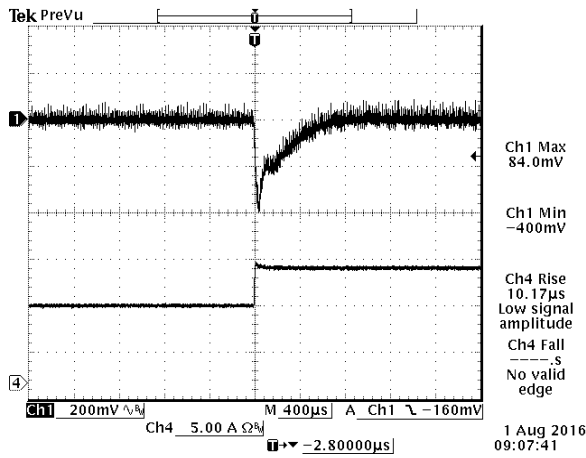

$V_{out}=12V$  50%-75% Load Transients at  $V_{in}=110V$ ,  $T_a=25\text{ deg C}$

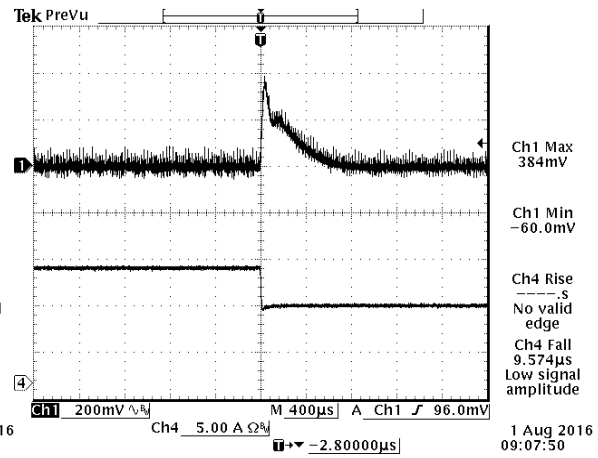

$V_{out}=12V$  75%-50% Load Transients at  $V_{in}=110V$ ,  $T_a=25\text{ deg C}$



## 11. REMOTE SENSE

This module has remote sense compensation feature. It can minimize the effects of resistance between module's output and load in system layout and facilitates accurate voltage regulation at load terminals or other selected point.

1. The remote sense lines carry very little current and hence do not require a large cross-sectional area.
2. This module compensates for a maximum drop of 4% of the nominal output voltage.
3. If the unit is already trimmed up, the available remote sense compensation range should be correspondingly reduced. The total voltage increased by trim and remote sense should not exceed 4% of the nominal output voltage.
4. When using remote sense compensation, all the resistance, parasitic inductance and capacitance of the system are incorporated within the feedback loop of this module. This can make an effect on the module's compensation, affecting the stability and dyn
5. Recommend the connection of remote sense compensation as below figure. There are a resistor  $RS+$  (100 ohm) from  $Vo+$  to  $Sense+$  and a resistor  $RS-$  (100 ohm) from  $Vo-$  to  $Sense-$  inside of this module.

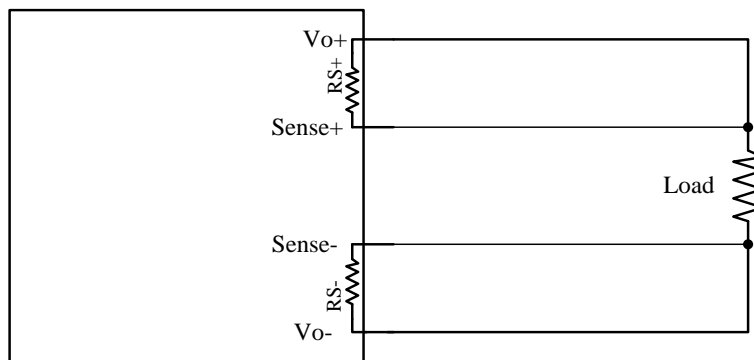

6. If not using remote sense compensation, please connect sense directly to output at module's pin, that is, connect  $sense+$  to  $Vo+$  and  $sense-$  to  $Vo-$  at module's pin, the shorter the better. see below figure.

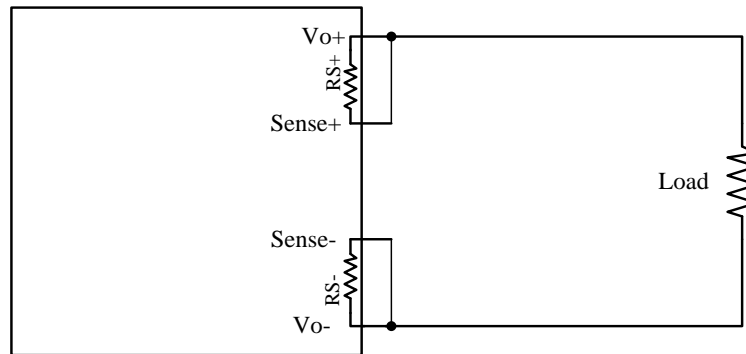

## 12. OVER CURRENT PROTECTION

To provide protection in a fault output overload condition, the module is equipped with internal current-limiting circuitry and can endure current limiting for a few milli-seconds. If the overcurrent condition persists beyond a few milliseconds, the module will shut down into hiccup mode and restart once every 800mS. The module operates normally when the output current goes into specified range. The typical average output current is 0.51A during hiccup.

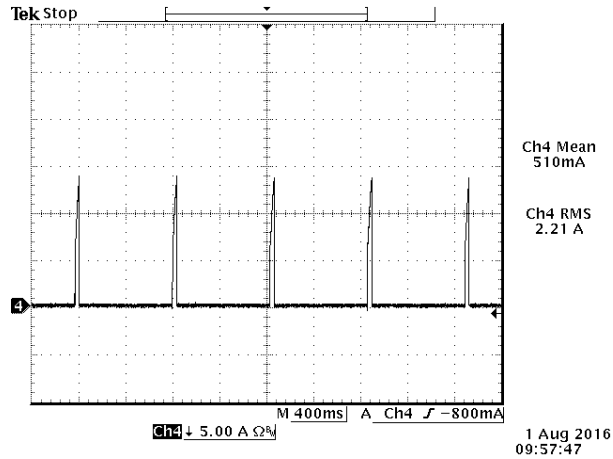

**13. OVER TEMPERATURE PROTECTION**

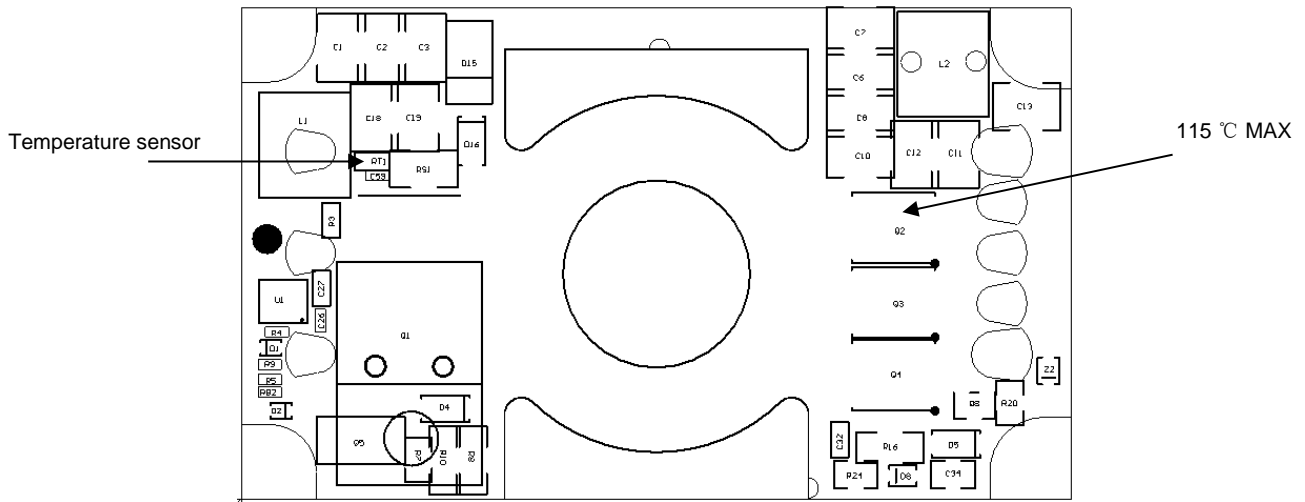

**14. INPUT UNDER-VOLTAGE LOCKOUT**

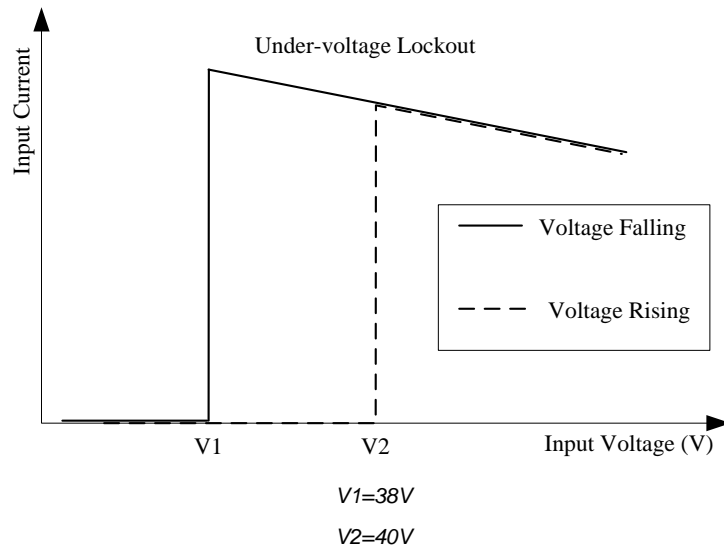

## 15. SAFETY & EMC

### Safety:

1. Compliance to UL/CSA 60950-1
2. Compliance to IEC/EN 60950-1

### EMC

Setup:

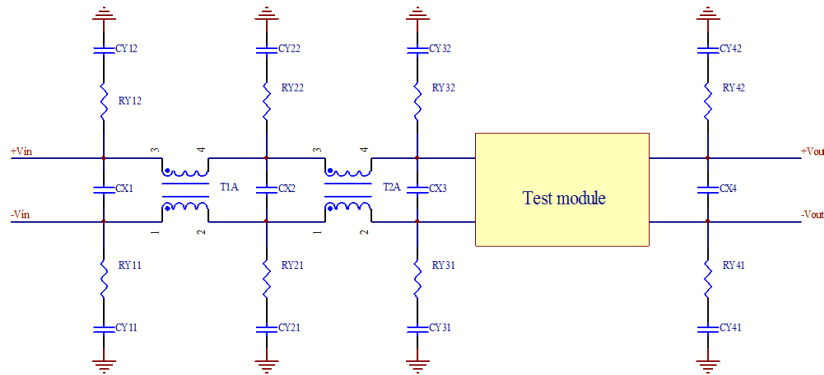

T1A	CX1	RY11	RY12	CY11	CY12
	330uF AL			-	
T2A	CX2	RY21	RY22	CY21	CY22
1mH	1uF	0R	0R	2.2uF	2.2uF
	CX3	RY31	RY32	CY31	CY32
	1uF				-
	CX4	RY41	RY42	CY41	CY42
	220uF AL			-	

## SAFETY & EMC(CONTINUED)

### Positive

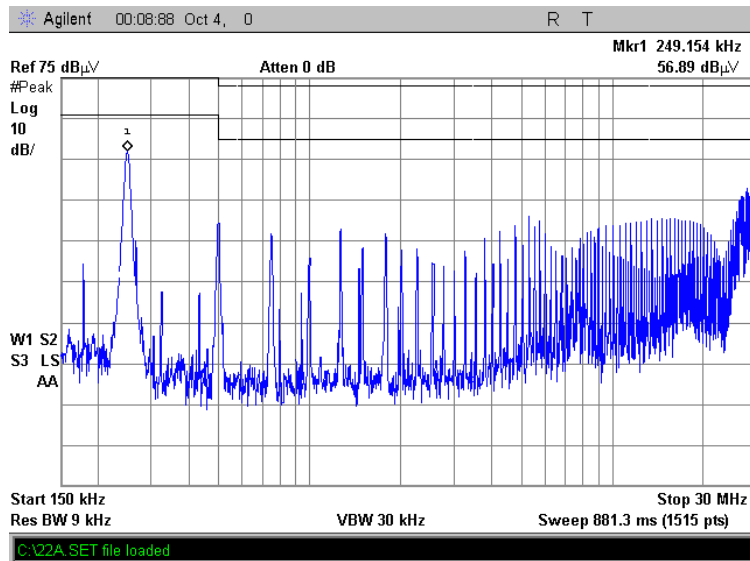

### Negative

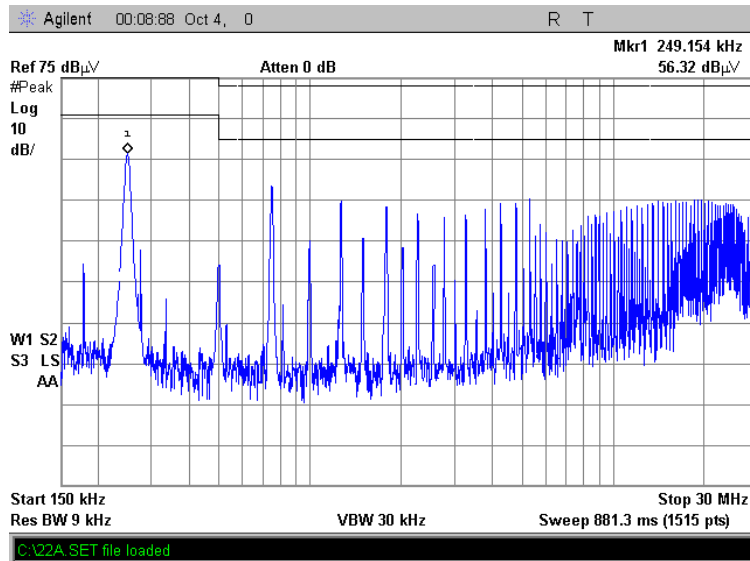

**16. TRIM**

0RQB-D0W12L Trim Resistor Calculate

Trim down test circuit

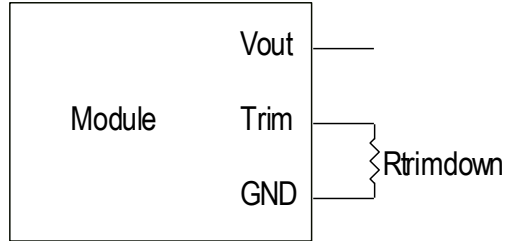

$$R_{trimdown} = \frac{Vo\_req}{12 - Vo\_req} - 1 [k\Omega]$$

Trim up test circuit

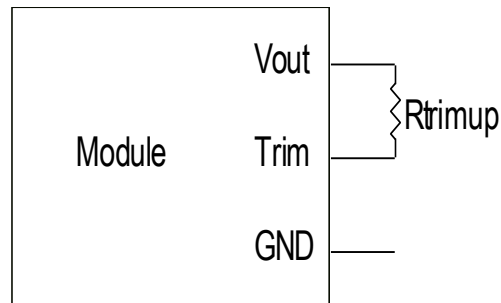

$$R_{trimup} = \frac{1 - 0.10332}{0.10332 - 1.24 / Vo\_req} - 1 [k\Omega]$$

**Note:** Vo\_req=Desired(trimmed) output voltage[V]

## 17. MECHANICAL DIMENSIONS

### OUTLINE

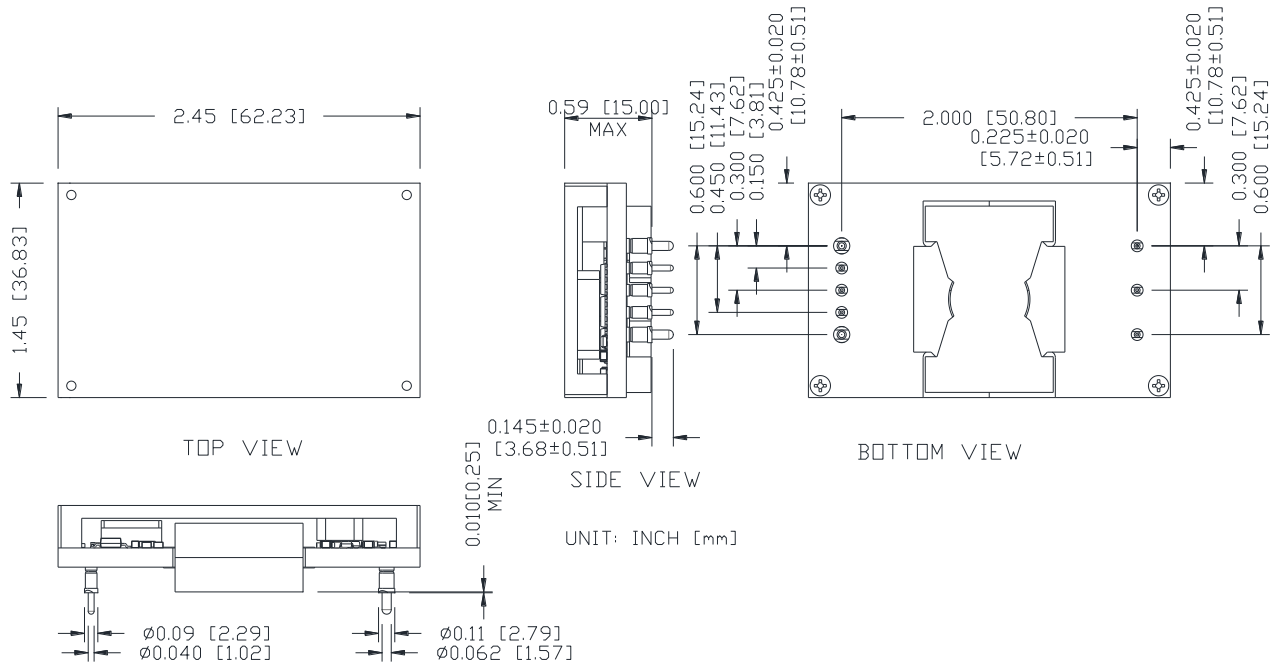

**Note:** This module is recommended and compatible with Pb-Free Wave Soldering and must be soldered using a peak solder temperature of no more than 260 °C for less than 5 seconds.

#### NOTES:

- 1) All Pins: Material - Copper Alloy;  
Finish – Tin plated
- 2) Undimensioned components are shown for visual reference only.
- 3) All dimensions in inches; Tolerances: x.xx +/-0.02 in [0.51 mm]. x.xxx +/-0.010 in [0.25 mm].

**MECHANICAL DIMENSIONS(CONTINUED)**

**PIN DEFINITIONS**

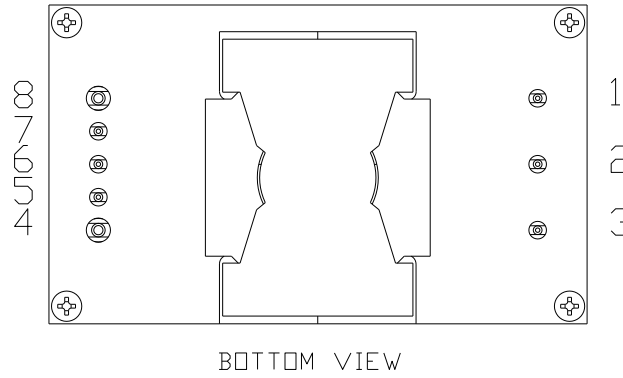

PIN	FUNCTION	PIN SIZE	Pin Length
1	Vin(+)	0.040"	0.145"
2	On/off	0.040"	0.145"
3	Vin(-)	0.040"	0.145"
4	Vout(-)	0.062"	0.145"
5	Sense(-)	0.040"	0.145"
6	Trim	0.040"	0.145"
7	Sense(+)	0.040"	0.145"
8	Vout(+)	0.062"	0.145"

**RECOMMENDED PAD LAYOUT**

RECOMMENDED PAD LAYOUT

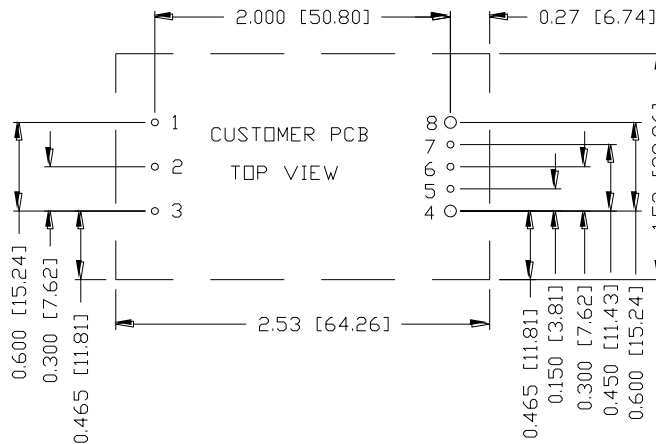

1,2,3,5,6,7  $\varnothing$ 0.047 HOLE SIZE,  $\varnothing$ 0.08 min PAD SIZE  
 4,8  $\varnothing$ 0.07 HOLE SIZE,  $\varnothing$ 0.10 min PAD SIZE



## 18. REVISION HISTORY

DATE	REVISION	CHANGES DETAIL	APPROVAL
2016-09-09	AA	First release	Z Tang
2017-04-13	AB	Update Input Voltage	J Yan
2017-06-07	AC	Update Input Specs	J Yan
2017-08-04	AD	Update Efficiency Data	S Wang
2017-08-22	AE	Update Operating Input Voltage	S Wang
2018-03-07	AF	Update MTBF	S Wang
2019-04-25	AG	Update Input Specifications and Mechanical Dimensions	S Wang

For more information on these products consult: [tech.support@psbel.com](mailto:tech.support@psbel.com)

**NUCLEAR AND MEDICAL APPLICATIONS** - Products are not designed or intended for use as critical components in life support systems, equipment used in hazardous environments, or nuclear control systems.

**TECHNICAL REVISIONS** - The appearance of products, including safety agency certifications pictured on labels, may change depending on the date manufactured. Specifications are subject to change without notice.



Asia-Pacific  
+86 755 298 85888

Europe, Middle East  
+353 61 225 977

North America  
+1 408 785 5200