

Powerex, Inc., 173 Pavilion Lane, Youngwood, Pennsylvania 15697 (724) 925-7272
www.pwr.com

POW-R-BLOK™
Dual Diode Isolated Module
600 Amperes / 1600 to 1800 Volts

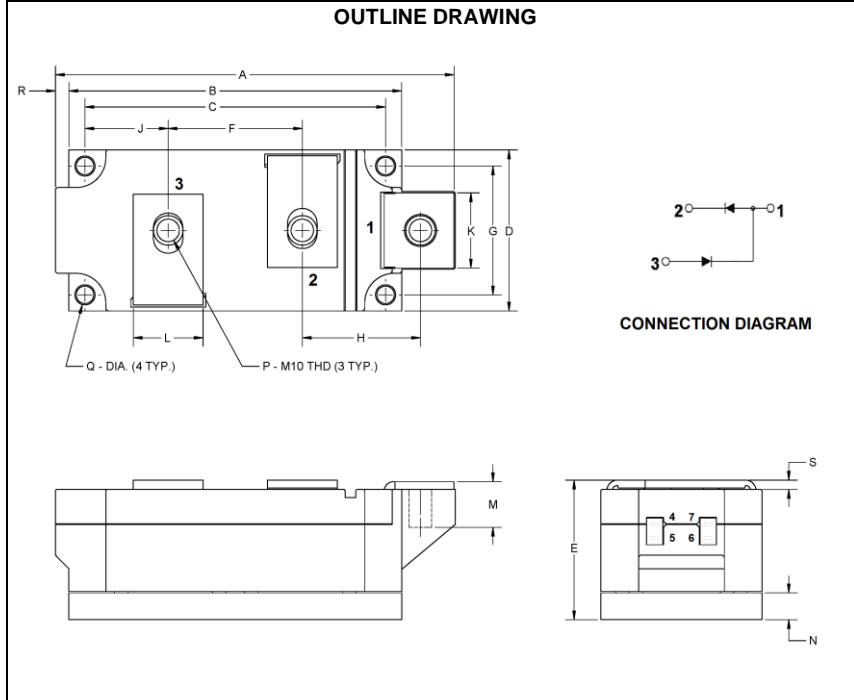

LDR1__66
Dual Diode
POW-R-BLOK™ Module
600 Amperes / 1600 to 1800 Volts

Description:

Powerex Dual Diode Modules are designed for use in applications requiring rectification and isolated packaging. The modules are isolated for easy mounting with other components on a common heatsink. *POW-R-BLOK™* has been tested and recognized by the Underwriters Laboratories.

Features:

- Electrically Isolated Heatsinking
- Compression Bonded Elements
- Metal Baseplate
- Low Thermal Impedance for Improved Current Capability
- UL Recognized (E78240)
- RoHS Compliant

Benefits:

- No Additional Insulation Components Required
- Easy Installation
- No Clamping Components Required
- Reduce Engineering Time

Applications:

- Bridge Circuits
- AC & DC Motor Drives
- Battery Supplies
- Power Supplies
- Large IGBT Circuit Front Ends

Ordering Information:

Select the complete eight-digit module part number from the table below.

Example: LDR11666 is a 1600V, 600 Ampere Dual Diode Isolated *POW-R-BLOK™* Module.

Type	Voltage Volts (x100)	Current Amperes
LDR1	16 18	66 (600A)

LDR1 Outline Dimensions

Dimension	Inches	Millimeters
A	5.87	149
B	4.88	124
C	4.41	112
D	2.36	60
E	2.05	52
F	1.97	50
G	1.89	48
H	1.73	44
J	1.22	31
K	1.10	28
L	1.02	26
M	0.67	17
N	0.39	10
P	M10 Metric	M10
Q	0.26 Dia.	6.5 Dia.
R	0.20	5

Absolute Maximum Ratings

Characteristics	Conditions	Symbol	Units	
Repetitive Peak Forward and Reverse Blocking Voltage		V_{DRM} & V_{RRM}	up to 1800	V
Non-Repetitive Peak Blocking Voltage ($t < 5$ msec)		V_{RSM}	$V_{RRM} + 100$	V
RMS Forward Current	180° Conduction, $T_C=100^\circ\text{C}$, 50 Hz	$I_{T(RMS)}$	1036	A
	180° Conduction, $T_C=106^\circ\text{C}$, 50 Hz	$I_{T(RMS)}$	942	A
Average Forward Current	180° Conduction, $T_C=100^\circ\text{C}$, 50 Hz	$I_{T(AV)}$	660	A
	180° Conduction, $T_C=106^\circ\text{C}$, 50 Hz	$I_{T(AV)}$	600	A
Peak One Cycle Surge Current, Non-Repetitive	60 Hz, 0V reapplied, $T_j = T_{j\max}$	I_{TSM}	20,000	A
	60 Hz, 0V reapplied, $T_j = 25^\circ\text{C}$	I_{TSM}	23,000	A
	50 Hz, 0V reapplied $T_j = T_{j\max}$	I_{TSM}	19,500	A
	50 Hz, 0V reapplied, $T_j = 25^\circ\text{C}$	I_{TSM}	22,000	A
I^2t for Fusing for One Cycle	60 Hz, 0V reapplied, $T_j = T_{j\max}$	I^2t	1.66×10^6	$\text{A}^2 \text{sec}$
	60 Hz, 0V reapplied, $T_j = 25^\circ\text{C}$	I^2t	2.19×10^6	$\text{A}^2 \text{sec}$
	50 Hz, 0V reapplied $T_j = T_{j\max}$	I^2t	1.80×10^6	$\text{A}^2 \text{sec}$
	50 Hz, 0V reapplied, $T_j = 25^\circ\text{C}$	I^2t	2.42×10^6	$\text{A}^2 \text{sec}$
Operating Temperature		T_J	-40 to +150	$^\circ\text{C}$
Storage Temperature		T_{stg}	-40 to +125	$^\circ\text{C}$
Max. Mounting Torque, M6 Mounting Screw			55	in. – Lb.
			6	Nm
Max. Mounting Torque, M10 Terminal Screw			110	in. – Lb.
			12	Nm
Module Weight, Typical			1.5	kg
			3.30	lb
V Isolation @ 25C	$t = 1$ minute, 50 Hz	V_{rms}	3000	V

Information presented is based upon manufacturers testing and projected capabilities.
 This information is subject to change without notice.
 The manufacturer makes no claim as to the suitability of use, reliability, capability,
 or future availability of this product.

Electrical Characteristics, T_J=25°C unless otherwise specified

Characteristics	Symbol	Test Conditions	Min.	Max.	Units
Repetitive Peak Forward Leakage Current	I _{DRM}	V _D = V _{DRM} , , T _J =130°C		50	mA
Peak On-State Voltage	V _{FM}	I _{TM} =1978A		1.40	V
Threshold Voltage, Low-level	V _{(TO)1}	T _J = 130°C, I = 0.5 I _{T(AV)} to 1.5 I _{T(AV)}		0.78	V
Slope Resistance, Low-level	r _{T1}			0.23	mΩ
V _{TM} Coefficients, Full Range		T _J = 130°C, I = 0.5 I _{T(AV)} to 1.5 I _{T(AV)}	A =	-3.37224	
			B =	0.943239	
		V _{TM} = A+ B·Ln(I) +C·I + D·Sqrt(I)	C =	0.00079	
			D =	-0.09266	

Thermal Characteristics

Characteristics	Symbol		Max.	Units
Thermal Resistance, Junction to Case	R _{θJ-C}	Per Module, both conducting	0.0325	°C/W
		Per Junction, both conducting	0.0650	°C/W
Thermal Impedance Coefficients	Z _{θJ-C}	Z _{θJ-C} = K ₁ (1-exp(-t/τ ₁))	K ₁ = 7.42E-04	τ ₁ = 3.33E-04
		+ K ₂ (1-exp(-t/τ ₂))	K ₂ = 9.52E-04	τ ₂ = 4.74E-03
		+ K ₃ (1-exp(-t/τ ₃))	K ₃ = 1.02E-02	τ ₃ = 9.60E-02
		+ K ₄ (1-exp(-t/τ ₄))	K ₄ = 5.23E-02	τ ₄ = 1.719
Thermal Resistance, Case to Sink Lubricated	R _{θC-S}	Per Module	0.01	°C/W

Powerex, Inc., 173 Pavilion Lane, Youngwood, Pennsylvania 15697 (724) 925-7272
www.pwr.com

POW-R-BLOK™ Dual Diode Isolated Module 600 Amperes / 1600 to 1800 Volts

Maximum On-State Forward Voltage Drop
(T_j = 150 °C)

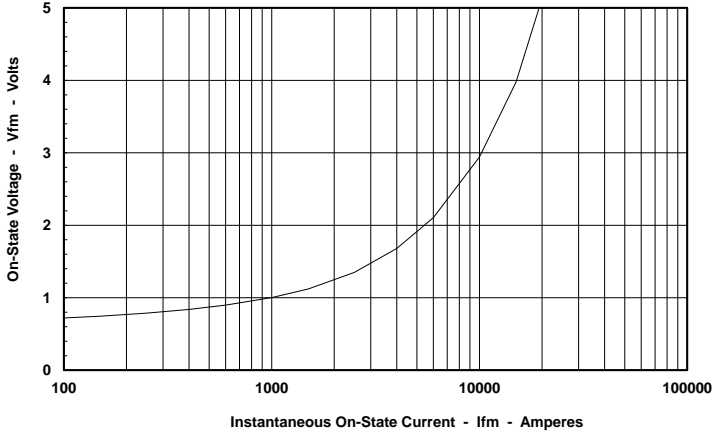

Maximum Transient Thermal Impedance
(Junction to Case)

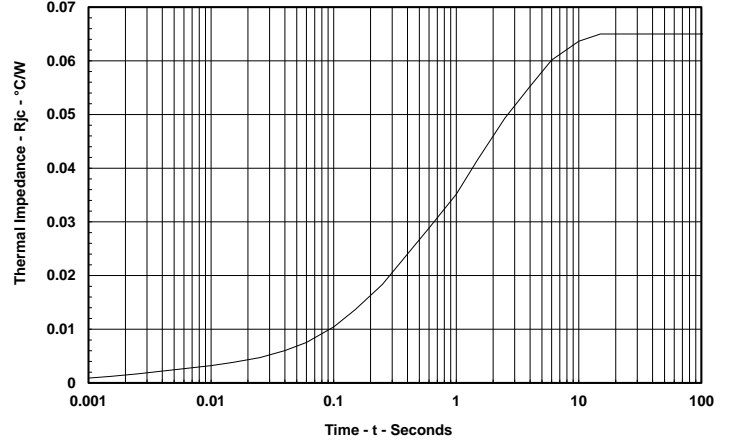

Maximum On-State Power Dissipation
(Sinusoidal Waveform)

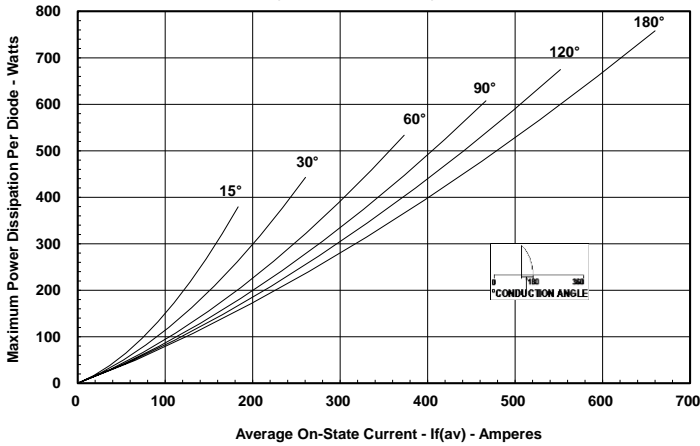

Maximum Allowable Case Temperature
(Sinusoidal Waveform)

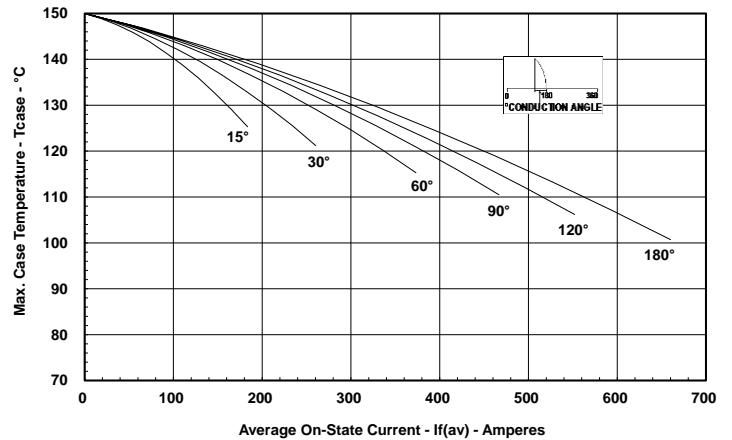

Maximum On-State Power Dissipation
(Rectangular Waveform)

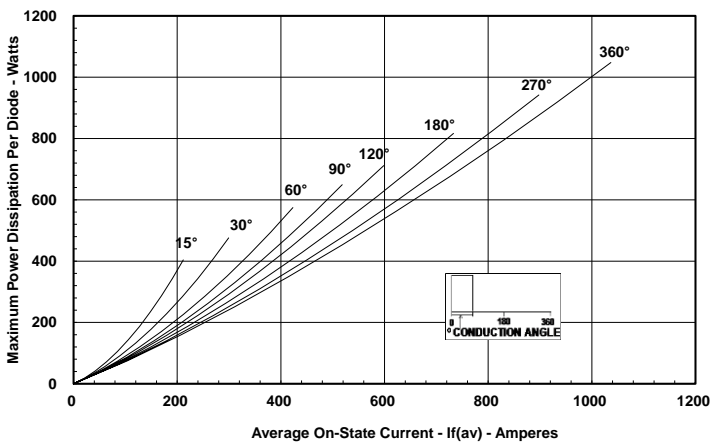

Maximum Allowable Case Temperature
(Rectangular Waveform)

