

6 Watt

- Regulated Single & Dual Output
- Wide 4:1 Input Range
- Compact SMD Package
- 1500 VDC Isolation
- Operating Temperature -40 °C to +100 °C
- Remote On/Off
- Tape & Reel Package Available
- Optional Water Washable Versions
- 3 Year Warranty

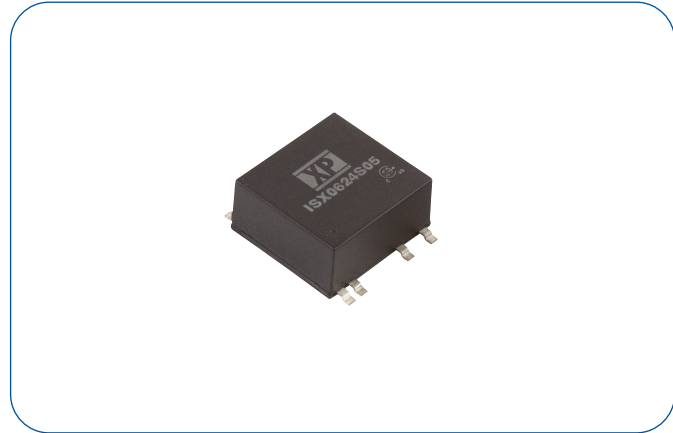

Dimensions:

ISX06:

1.0 x 0.87 x 0.4" (25.4 x 22.0 x 10.2 mm)

Models & Ratings

Input Voltage	Output Voltage	Output Current		Input Current ^(1,2)		Maximum Capacitive Load ⁽³⁾	Efficiency	Model Number ⁽⁴⁾
		Min	Max	No Load	Full Load			
9-36 V	3.3 V	218 mA	1450 mA	30 mA	262 mA	330 µF	76%	ISX0624S3V3
	5.0 V	180 mA	1200 mA	30 mA	316 mA	330 µF	79%	ISX0624S05
	12.0 V	75 mA	500 mA	30 mA	300 mA	100 µF	83%	ISX0624S12
	15.0 V	60 mA	400 mA	30 mA	300 mA	100 µF	83%	ISX0624S15
	24.0 V	38 mA	250 mA	30 mA	300 mA	100 µF	83%	ISX0624S24
	±5.0 V	±90 mA	±600 mA	30 mA	300 mA	±100 µF	82%	ISX0624D05
	±12.0 V	±38 mA	±250 mA	30 mA	300 mA	±100 µF	83%	ISX0624D12
18-75 V	3.3 V	218 mA	1450 mA	20 mA	130 mA	330 µF	76%	ISX0648S3V3
	5.0 V	180 mA	1200 mA	20 mA	160 mA	330 µF	79%	ISX0648S05
	12.0 V	75 mA	500 mA	20 mA	150 mA	100 µF	83%	ISX0648S12
	15.0 V	60 mA	400 mA	20 mA	150 mA	100 µF	83%	ISX0648S15
	24.0 V	38 mA	250 mA	20 mA	150 mA	100 µF	83%	ISX0648S24
	±5.0 V	±90 mA	±600 mA	20 mA	150 mA	±100 µF	82%	ISX0648D05
	±12.0 V	±38 mA	±250 mA	20 mA	150 mA	±100 µF	83%	ISX0648D12
	±15.0 V	±30 mA	±200 mA	20 mA	150 mA	±100 µF	83%	ISX0648D15

Notes

1. Input currents measured at nominal input voltage.
2. Input current is typically 10 mA at nominal input voltage when output is remotely turned off.
3. Maximum capacitive load is per output.
4. For optional water washable version, add suffix '-P' e.g. ISX0624S12-P.

Mechanical Details

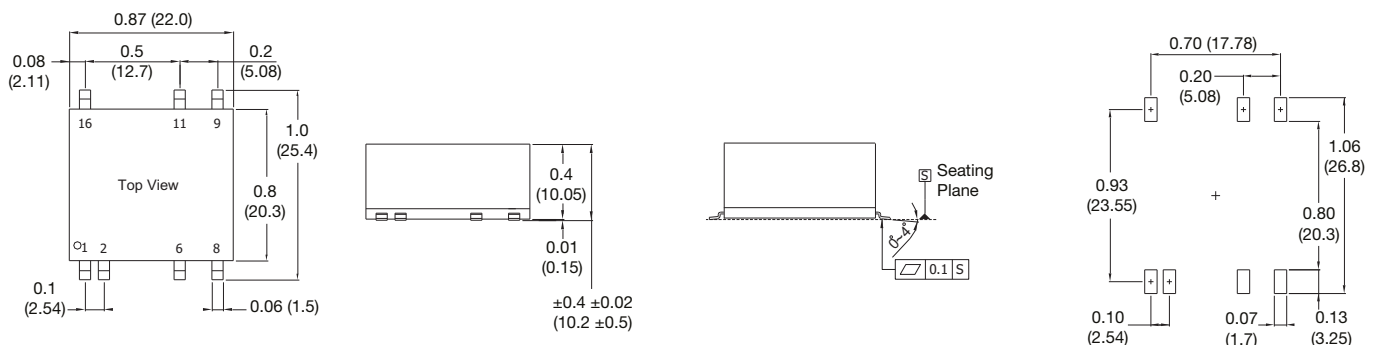

Input

Characteristic	Minimum	Typical	Maximum	Units	Notes & Conditions
Input Voltage Range	9		36	VDC	24 V nominal
	18		75	VDC	48 V nominal
Input Filter	Pi type				
Input Reflected Ripple		20		mA pk-pk	Through 12 μ H inductor and 47 μ F capacitor
Input Surge			50	VDC for 1 s	24 V models
			100	VDC for 1 s	48 V models
Undervoltage Lockout	ON at >4.5 V, OFF at <8 V				24 V models
	ON at >8.5 V, OFF at <17 V				48 V models
Remote On/Off	ON: Logic high (2.5 - 50 V) or open circuit OFF: Logic low (<0.8 V) or short pin 1 to pin 2				

Output

Characteristic	Minimum	Typical	Maximum	Units	Notes & Conditions
Output Voltage	3.3		30	VDC	See Models and Ratings table
Initial Set Accuracy		± 1.0	± 2.0	%	
Output Voltage Balance		± 1.0		%	For dual output with balanced loads
Minimum Load				A	See Models and Ratings table
Line Regulation		± 0.5	± 1.0	%	
Load Regulation		± 0.5	± 1.2	%	15% to 100% load
Cross Regulation			± 5	%	On dual output models when one load is varied between 25% and 100% and other is fixed at 100%
Transient Response		3		% deviation	Recovery within 1% in less than 600 μ s for a 25% load change.
Ripple & Noise			100	mV pk-pk	20 MHz bandwidth. Measured using 0.47 μ F ceramic capacitor.
Overload Protection	110	150		%	Foldback
Short Circuit Protection					Continuous, with auto recovery
Maximum Capacitive Load					See Models and Ratings table
Temperature Coefficient			0.02	%/ $^{\circ}$ C	

General

Characteristic	Minimum	Typical	Maximum	Units	Notes & Conditions
Efficiency		80		%	See Models and Ratings table
Isolation: Input to Output	1500/1800			VDC	60 s/1 s
Isolation Resistance	10^9			Ω	At 500 VDC
Isolation Capacitance		1200	1500	pF	
Switching Frequency		330		kHz	
Power Density			17.2	W/in ³	
Mean Time Between Failure		350		kHrs	MIL-HDBK-217F, +25 $^{\circ}$ C GB
Weight		0.017 (7.8)		lb (g)	
Moisture Sensitivity Level	Level 2				IPC/JEDEC J-STD-020D.1

Environmental

Characteristic	Minimum	Typical	Maximum	Units	Notes & Conditions
Operating Temperature	-40		+100	$^{\circ}$ C	See Derating Curve.
Storage Temperature	-50		+125	$^{\circ}$ C	
Case Temperature			+105	$^{\circ}$ C	
Humidity			95	%RH	Non-condensing
Cooling					Natural convection
Case Flammability	UL 94V-0 Rated				Non conductive black plastic
Lead-Free Reflow Solder Process					IPC/JEDEC J-STD-020D.1

Safety Approvals

Safety Agency	Safety Standard	Notes & Conditions
CB	IEC60950-1	ITE
CSA	UL60950-1 & CSA-C22.2 No. 60950-1	ITE

EMC: Emissions

Phenomenon	Standard	Test Level	Notes & Conditions
Conducted	EN55032	Class A	

Mechanical Details

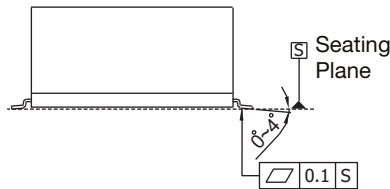
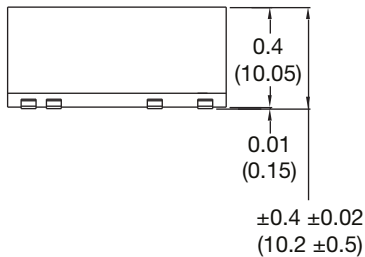
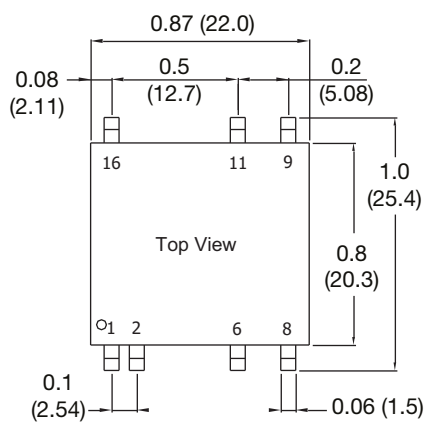

Connecting Pin Pattern

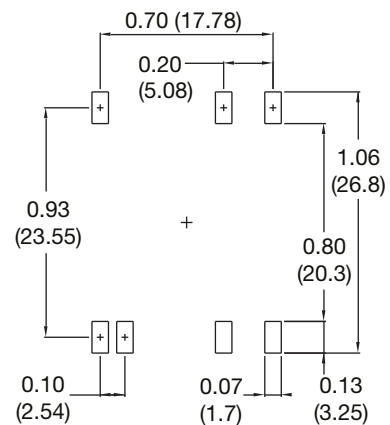

Pin	Pin Connections	
	Single	Dual
1	Remote On/Off	Remote On/Off
2	-Vin	-Vin
6	No Connection	Common
8	No Connection	-Vout
9	+Vout	+Vout
11	-Vout	Common
16	+Vin	+Vin

Application Notes

Derating Curve

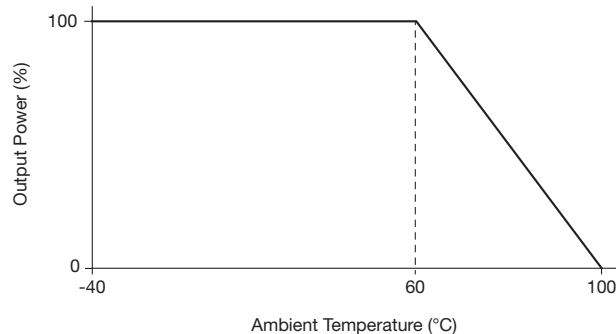

Notes

- All dimensions are in inches (mm)
- Weight: 0.017 lbs (7.8 g) approx.

- Tolerance: X.XX±0.01 (X.X±0.25)
X.XXX±0.005 (X.XX±0.13)
- Pin Tolerance: ±0.002 (±0.05)