

T111B235K050AS

Aliases (T111B235K050AS{Bulk})

T111, Tantalum, MnO2 Tantalum, Commercial Grade, 2.3 uF, 10%, 50 VDC

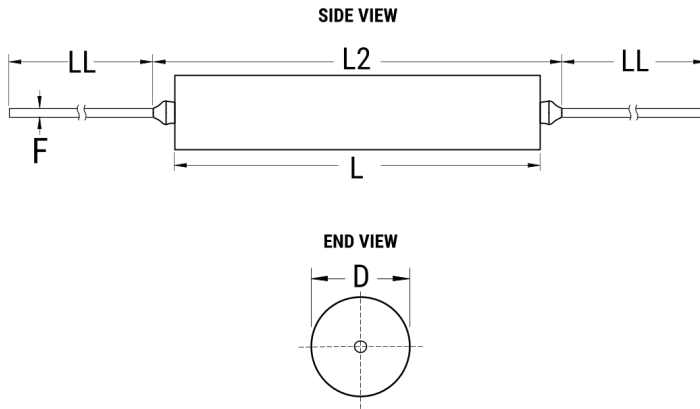

Click [here](#) for the 3D model.

Dimensions

D	5.26mm +0.25/-0.38mm
L	24.26mm +/-0.79mm
L2	28.7mm
LL	38.1mm +/-6.35mm
F	0.51mm +/-0.05mm

Packaging Specifications

Packaging	Bulk, Bag
Packaging Quantity	30

General Information

Series	T111
Dielectric	MnO2 Tantalum
Style	Axial Hermetic
Description	Axial, Solid Tantalum, Hermetically Sealed, Military (Non-ER), Non-Polar
Features	BiPolar, Low Leakage, Low DF
RoHS	No
Prop 65	⚠ WARNING: Cancer and reproductive harm - http://www.p65warnings.ca.gov .
SCIP Number	be146961-2c72-4b45-804a-c62bf7a8b23e
Termination	Lead (SnPb)
Lead	Wire Leads
AEC-Q200	No
Construction	Hermetic
Notes	Dimensions Include Insulation Sleeve. When Supplied On T&R Or Ammo, Lead Length Is Determined By Taping Specification.

Specifications

Capacitance	2.3 uF
Capacitance Tolerance	10%
Voltage DC	50 VDC (85C), 40 VDC (125C Surge), 33 VDC (125C Reverse)
Temperature Range	-55/+125°C
Rated Temperature	85°C
Dissipation Factor	4%
Leakage Current	1.7 uA (25°C)