

XIO2213A PCI Express to 1394b OHCI with 3-Port PHY

Data Manual



PRODUCTION DATA information is current as of publication date. Products conform to specifications per the terms of the Texas Instruments standard warranty. Production processing does not necessarily include testing of all parameters.

Literature Number: SCPS183A
October 2007–Revised March 2008

Contents

| | | |
|----------|--|-----------|
| 1 | Introduction | 13 |
| 1.1 | XIO2213A Features | 13 |
| 2 | Overview | 14 |
| 2.1 | Description | 14 |
| 2.2 | Related Documents | 16 |
| 2.3 | Trademarks | 16 |
| 2.4 | Documents Conventions | 16 |
| 2.5 | Ordering Information | 17 |
| 2.6 | Terminal Assignments | 17 |
| 2.7 | Terminal Descriptions | 21 |
| 3 | Feature/Protocol Descriptions | 29 |
| 3.1 | Power-Up/-Down Sequencing | 29 |
| 3.1.1 | Power-Up Sequence | 30 |
| 3.1.2 | Power-Down Sequence | 31 |
| 3.2 | XIO2213A Reset Features | 31 |
| 3.3 | PCI Express Interface | 32 |
| 3.3.1 | External Reference Clock | 32 |
| 3.3.2 | Beacon and Wake | 32 |
| 3.3.3 | Initial Flow Control Credits | 32 |
| 3.3.4 | PCI Express Message Transactions | 33 |
| 3.4 | PCI Interrupt Conversion to PCI Express Messages | 34 |
| 3.5 | Two-Wire Serial-Bus Interface | 34 |
| 3.5.1 | Serial-Bus Interface Implementation | 34 |
| 3.5.2 | Serial-Bus Interface Protocol | 35 |
| 3.5.3 | Serial-Bus EEPROM Application | 37 |
| 3.5.4 | Accessing Serial-Bus Devices Through Software | 39 |
| 3.6 | Advanced Error Reporting Registers | 40 |
| 3.7 | Data Error Forwarding Capability | 40 |
| 3.8 | General-Purpose I/O Interface | 40 |
| 3.9 | Set Slot Power Limit Functionality | 40 |
| 3.10 | PCI Express and PCI Bus Power Management | 41 |
| 3.11 | 1394b OHCI Controller Functionality | 42 |
| 3.11.1 | 1394b OHCI Power Management | 42 |
| 3.11.2 | 1394b OHCI and V_{AUX} | 42 |
| 3.11.3 | 1394b OHCI and Reset Options | 42 |
| 3.11.4 | 1394b OHCI PCI Bus Master | 42 |
| 3.11.5 | 1394b OHCI Subsystem Identification | 43 |
| 3.11.6 | 1394b OHCI PME Support | 43 |
| 4 | Classic PCI Configuration Space | 44 |
| 4.1 | Vendor ID Register | 45 |
| 4.2 | Device ID Register | 45 |
| 4.3 | Command Register | 45 |
| 4.4 | Status Register | 47 |
| 4.5 | Class Code and Revision ID Register | 48 |
| 4.6 | Cache Line Size Register | 48 |
| 4.7 | Primary Latency Timer Register | 48 |
| 4.8 | Header Type Register | 49 |
| 4.9 | BIST Register | 49 |
| 4.10 | Device Control Base Address Register | 49 |
| 4.11 | Scratchpad RAM Base Address | 49 |

| | | |
|------|--|--------------------|
| 4.12 | Primary Bus Number Register | 50 |
| 4.13 | Secondary Bus Number Register | 50 |
| 4.14 | Subordinate Bus Number Register | 50 |
| 4.15 | Secondary Latency Timer Register | 51 |
| 4.16 | I/O Base Register | 52 |
| 4.17 | I/O Limit Register | 52 |
| 4.18 | Secondary Status Register..... | 53 |
| 4.19 | Memory Base Register | 54 |
| 4.20 | Memory Limit Register..... | 54 |
| 4.21 | Prefetchable Memory Base Register | 54 |
| 4.22 | Prefetchable Memory Limit Register..... | 55 |
| 4.23 | Prefetchable Base Upper 32 Bits Register..... | 55 |
| 4.24 | Prefetchable Limit Upper 32 Bits Register | 55 |
| 4.25 | I/O Base Upper 16 Bits Register | 56 |
| 4.26 | I/O Limit Upper 16 Bits Register..... | 56 |
| 4.27 | Capabilities Pointer Register..... | 56 |
| 4.28 | Interrupt Line Register | 57 |
| 4.29 | Interrupt Pin Register | 57 |
| 4.30 | Bridge Control Register..... | 58 |
| 4.31 | Capability ID Register..... | 60 |
| 4.32 | Next Item Pointer Register | 60 |
| 4.33 | Power Management Capabilities Register | 60 |
| 4.34 | Power Management Control/Status Register..... | 61 |
| 4.35 | Power Management Bridge Support Extension Register | 61 |
| 4.36 | Power Management Data Register | 62 |
| 4.37 | MSI Capability ID Register | 62 |
| 4.38 | Next Item Pointer Register | 62 |
| 4.39 | MSI Message Control Register..... | 63 |
| 4.40 | MSI Message Lower Address Register | 63 |
| 4.41 | MSI Message Upper Address Register | 64 |
| 4.42 | MSI Message Data Register..... | 64 |
| 4.43 | Capability ID Register..... | 65 |
| 4.44 | Next Item Pointer Register | 65 |
| 4.45 | Subsystem Vendor ID Register..... | 65 |
| 4.46 | Subsystem ID Register | 65 |
| 4.47 | PCI Express Capability ID Register..... | 65 |
| 4.48 | Next Item Pointer Register | 66 |
| 4.49 | PCI Express Capabilities Register | 66 |
| 4.50 | Device Capabilities Register | 67 |
| 4.51 | Device Control Register | 68 |
| 4.52 | Device Status Register | 69 |
| 4.53 | Link Capabilities Register | 70 |
| 4.54 | Link Control Register | 71 |
| 4.55 | Link Status Register..... | 72 |
| 4.56 | Serial-Bus Data Register | 72 |
| 4.57 | Serial-Bus Word Address Register..... | 72 |
| 4.58 | Serial-Bus Slave Address Register | 73 |
| 4.59 | Serial-Bus Control and Status Register | 73 |
| 4.60 | GPIO Control Register..... | 75 |
| 4.61 | GPIO Data Register..... | 76 |
| 4.62 | Control and Diagnostic Register 0 | 77 |
| 4.63 | Control and Diagnostic Register 1 | 78 |
| 4.64 | PHY Control and Diagnostic Register 2 | 80 |

| | | |
|----------|--|----------------------------|
| 4.65 | Subsystem Access Register | 80 |
| 4.66 | General Control Register | 81 |
| 4.67 | TI Proprietary Register | 83 |
| 4.68 | TI Proprietary Register | 83 |
| 4.69 | TI Proprietary Register..... | 84 |
| 4.70 | Arbiter Control Register | 85 |
| 4.71 | Arbiter Request Mask Register | 86 |
| 4.72 | Arbiter Time-Out Status Register | 86 |
| 4.73 | TI Proprietary Register..... | 87 |
| 4.74 | TI Proprietary Register | 87 |
| 4.75 | TI Proprietary Register..... | 87 |
| 5 | PCI Express Extended Configuration Space | 89 |
| 5.1 | Advanced Error Reporting Capability ID Register | 89 |
| 5.2 | Next Capability Offset/Capability Version Register | 89 |
| 5.3 | Uncorrectable Error Status Register | 91 |
| 5.4 | Uncorrectable Error Mask Register | 91 |
| 5.5 | Uncorrectable Error Severity Register..... | 93 |
| 5.6 | Correctable Error Status Register..... | 94 |
| 5.7 | Correctable Error Mask Register | 95 |
| 5.8 | Advanced Error Capabilities and Control Register..... | 96 |
| 5.9 | Header Log Register..... | 96 |
| 5.10 | Secondary Uncorrectable Error Status Register | 97 |
| 5.11 | Secondary Uncorrectable Error Mask Register | 98 |
| 5.12 | Secondary Uncorrectable Error Severity | 99 |
| 5.13 | Secondary Error Capabilities and Control Register | 100 |
| 5.14 | Secondary Header Log Register..... | 101 |
| 6 | Memory-Mapped TI Proprietary Register Space | 102 |
| 6.1 | Device Control Map ID Register | 102 |
| 6.2 | Revision ID Register..... | 103 |
| 6.3 | GPIO Control Register | 103 |
| 6.4 | GPIO Data Register | 104 |
| 6.5 | Serial-Bus Data Register | 105 |
| 6.6 | Serial-Bus Word Address Register | 105 |
| 6.7 | Serial-Bus Slave Address Register | 105 |
| 6.8 | Serial-Bus Control and Status Register..... | 105 |
| 7 | 1394 OHCI—PCI Configuration Space | 107 |
| 7.1 | Vendor ID Register | 108 |
| 7.2 | Device ID Register..... | 108 |
| 7.3 | Command Register | 108 |
| 7.4 | Status Register..... | 109 |
| 7.5 | Class Code and Revision ID Register | 110 |
| 7.6 | Cache Line Size and Latency Timer Register | 110 |
| 7.7 | Header Type and BIST Register..... | 111 |
| 7.8 | OHCI Base Address Register | 111 |
| 7.9 | TI Extension Base Address Register..... | 112 |
| 7.10 | CIS Base Address Register | 113 |
| 7.11 | CIS Pointer Register..... | 113 |
| 7.12 | Subsystem Identification Register | 113 |
| 7.13 | Power Management Capabilities Pointer Register | 114 |
| 7.14 | Interrupt Line and Pin Register | 114 |
| 7.15 | MIN_GNT and MAX_LAT Register..... | 114 |
| 7.16 | OHCI Control Register | 115 |

| | | |
|----------|--|----------------------------|
| 7.17 | Capability ID and Next Item Pointer Registers | 115 |
| 7.18 | Power Management Capabilities Register | 116 |
| 7.19 | Power Management Control and Status Register | 116 |
| 7.20 | Power Management Extension Registers | 117 |
| 7.21 | PCI Miscellaneous Configuration Register | 118 |
| 7.22 | Link Enhancement Control Register | 119 |
| 7.23 | Subsystem Access Register..... | 121 |
| 8 | 1394 OHCI Memory-Mapped Register Space | 122 |
| 8.1 | OHCI Version Register..... | 124 |
| 8.2 | GUID ROM Register | 125 |
| 8.3 | Asynchronous Transmit Retries Register..... | 126 |
| 8.4 | CSR Data Register | 126 |
| 8.5 | CSR Compare Register..... | 127 |
| 8.6 | CSR Control Register | 127 |
| 8.7 | Configuration ROM Header Register..... | 127 |
| 8.8 | Bus Identification Register..... | 128 |
| 8.9 | Bus Options Register..... | 128 |
| 8.10 | GUID High Register | 129 |
| 8.11 | GUID Low Register..... | 130 |
| 8.12 | Configuration ROM Mapping Register | 130 |
| 8.13 | Posted Write Address Low Register | 130 |
| 8.14 | Posted Write Address High Register..... | 131 |
| 8.15 | Vendor ID Register | 131 |
| 8.16 | Host Controller Control Register..... | 131 |
| 8.17 | Self-ID Buffer Pointer Register..... | 133 |
| 8.18 | Self-ID Count Register | 133 |
| 8.19 | Isochronous Receive Channel Mask High Register..... | 134 |
| 8.20 | Isochronous Receive Channel Mask Low Register | 135 |
| 8.21 | Interrupt Event Register..... | 135 |
| 8.22 | Interrupt Mask Register | 137 |
| 8.23 | Isochronous Transmit Interrupt Event Register..... | 139 |
| 8.24 | Isochronous Transmit Interrupt Mask Register | 139 |
| 8.25 | Isochronous Receive Interrupt Event Register..... | 140 |
| 8.26 | Isochronous Receive Interrupt Mask Register | 140 |
| 8.27 | Initial Bandwidth Available Register..... | 141 |
| 8.28 | Initial Channels Available High Register..... | 141 |
| 8.29 | Initial Channels Available Low Register | 142 |
| 8.30 | Fairness Control Register..... | 143 |
| 8.31 | Link Control Register | 144 |
| 8.32 | Node Identification Register | 145 |
| 8.33 | PHY Layer Control Register..... | 146 |
| 8.34 | Isochronous Cycle Timer Register | 147 |
| 8.35 | Asynchronous Request Filter High Register | 148 |
| 8.36 | Asynchronous Request Filter Low Register | 150 |
| 8.37 | Physical Request Filter High Register | 151 |
| 8.38 | Physical Request Filter Low Register | 153 |
| 8.39 | Physical Upper Bound Register (Optional Register) | 153 |
| 8.40 | Asynchronous Context Control Register..... | 154 |
| 8.41 | Asynchronous Context Command Pointer Register..... | 155 |
| 8.42 | Isochronous Transmit Context Control Register..... | 156 |
| 8.43 | Isochronous Transmit Context Command Pointer Register..... | 157 |
| 8.44 | Isochronous Receive Context Control Register..... | 157 |
| 8.45 | Isochronous Receive Context Command Pointer Register | 158 |

| | | |
|-----------|--|----------------------------|
| 8.46 | Isynchronous Receive Context Match Register | 159 |
| 9 | 1394 OHCI Memory-Mapped TI Extension Register Space..... | 160 |
| 9.1 | DV and MPEG2 Timestamp Enhancements | 160 |
| 9.2 | Isynchronous Receive Digital Video Enhancements | 160 |
| 9.3 | Isynchronous Receive Digital Video Enhancements Register | 161 |
| 9.4 | Link Enhancement Register | 162 |
| 9.5 | Timestamp Offset Register | 164 |
| 10 | PHY Section | 165 |
| 10.1 | PHY Section Register Configuration | 166 |
| 10.2 | PHY Section Application Information..... | 172 |
| 10.2.1 | Power Class Programming | 172 |
| 10.2.2 | Power-Up Reset..... | 172 |
| 10.2.3 | Crystal Oscillator Selection | 172 |
| 10.2.4 | Bus Reset | 173 |
| 11 | Electrical Characteristics | 175 |
| 11.1 | Absolute Maximum Ratings | 175 |
| 11.2 | Recommended Operating Conditions..... | 175 |
| 11.3 | PCI Express Differential Transmitter Output Ranges | 175 |
| 11.4 | PCI Express Differential Receiver Input Ranges | 177 |
| 11.5 | PCI Express Differential Reference Clock Input Ranges..... | 178 |
| 11.6 | Electrical Characteristics Over Recommended Operating Conditions (3.3-V I/O) | 178 |
| 11.7 | Electrical Characteristics Over Recommended Operating Conditions (PHY Port Driver) | 179 |
| 11.8 | Switching Characteristics for PHY Port Driver | 179 |
| 11.9 | Electrical Characteristics Over Recommended Operating Conditions PHY Port Receiver | 180 |
| 11.10 | Jitter/Skew Characteristics for 1394a PHY Port Receiver | 180 |
| 11.11 | Operating, Timing, and Switching Characteristics of XI | 180 |
| 11.12 | Electrical Characteristics Over Recommended Operating Conditions (1394a Miscellaneous I/O) | 180 |
| 12 | Glossary | 181 |
| 13 | Mechanical Data | 182 |
| | Important Notices | 183 |

List of Figures

| | | |
|------|--|---------------------|
| 3-1 | XIO2213A Block Diagram..... | 29 |
| 3-2 | Power-Up Sequence..... | 30 |
| 3-3 | Power-Down Sequence | 31 |
| 3-4 | PCI Express ASSERT_INTA Message..... | 34 |
| 3-5 | PCI Express DEASSERT_INTX Message..... | 34 |
| 3-6 | Serial EEPROM Application | 35 |
| 3-7 | Serial-Bus Start/Stop Conditions and Bit Transfers | 35 |
| 3-8 | Serial-Bus Protocol Acknowledge..... | 36 |
| 3-9 | Serial-Bus Protocol – Byte Write | 36 |
| 3-10 | Serial-Bus Protocol – Byte Read..... | 37 |
| 3-11 | Serial-Bus Protocol – Multibyte Read | 37 |
| 11-1 | Test Load Diagram | 179 |

List of Tables

| | | |
|------|--|--------------------|
| 2-1 | XIO2213AZAY_12x12 Terminals Sorted Alphanumerically | 18 |
| 2-2 | XIO2213AZAY_12x12 Signals Sorted Alphanumerically | 20 |
| 2-3 | Power Supply Terminals | 23 |
| 2-4 | Ground Terminals | 23 |
| 2-5 | PCI Express Terminals | 24 |
| 2-6 | Clock Terminals | 24 |
| 2-7 | 1394 Terminals | 24 |
| 2-8 | Reserved Terminals | 27 |
| 2-9 | Miscellaneous Terminals | 27 |
| 3-1 | XIO2213A Reset Options | 31 |
| 3-2 | Initial Flow Control Credit Advertisements | 32 |
| 3-3 | Messages Supported by the Bridge | 33 |
| 3-4 | EEPROM Register Loading Map..... | 37 |
| 3-5 | Registers Used To Program Serial-Bus Devices | 39 |
| 3-6 | Clocking In Low Power States..... | 41 |
| 3-7 | 1394b OHCI Configuration Register Map..... | 42 |
| 3-8 | 1394 OHCI Memory Command Options | 43 |
| 4-1 | Classic PCI Configuration Register Map | 44 |
| 4-2 | Command Register Description | 46 |
| 4-3 | Status Register Description | 47 |
| 4-4 | Class Code and Revision ID Register Description | 48 |
| 4-5 | Device Control Base Address Register Description | 49 |
| 4-6 | Device Control Base Address Register Description | 50 |
| 4-7 | I/O Base Register Description | 52 |
| 4-8 | I/O Limit Register Description | 52 |
| 4-9 | Secondary Status Register Description | 53 |
| 4-10 | Memory Base Register Description | 54 |
| 4-11 | Memory Limit Register Description | 54 |
| 4-12 | Prefetchable Memory Base Register Description | 54 |
| 4-13 | Prefetchable Memory Limit Register Description | 55 |
| 4-14 | Prefetchable Base Upper 32 Bits Register Description | 55 |
| 4-15 | Prefetchable Limit Upper 32 Bits Register Description..... | 56 |
| 4-16 | I/O Base Upper 16 Bits Register Description..... | 56 |
| 4-17 | I/O Limit Upper 16 Bits Register Description | 56 |
| 4-18 | Bridge Control Register Description | 58 |
| 4-19 | Power Management Capabilities Register Description | 60 |
| 4-20 | Power Management Control/Status Register Description | 61 |
| 4-21 | PM Bridge Support Extension Register Description | 62 |
| 4-22 | MSI Message Control Register Description | 63 |

| | | |
|------|--|---------------------|
| 4-23 | MSI Message Lower Address Register Description | 64 |
| 4-24 | MSI Message Data Register Description | 64 |
| 4-25 | PCI Express Capabilities Register Description..... | 66 |
| 4-26 | Device Capabilities Register Description | 67 |
| 4-27 | Device Control Register Description..... | 68 |
| 4-28 | Device Status Register Description..... | 69 |
| 4-29 | Link Capabilities Register Description | 70 |
| 4-30 | Link Control Register Description | 71 |
| 4-31 | Link Status Register Description | 72 |
| 4-32 | Serial-Bus Slave Address Register Descriptions | 73 |
| 4-33 | Serial-Bus Control and Status Register Description..... | 73 |
| 4-34 | GPIO Control Register Description | 75 |
| 4-35 | GPIO Data Register Description | 76 |
| 4-36 | Control and Diagnostic Register 0 Description | 77 |
| 4-37 | Control and Diagnostic Register 1 Description | 78 |
| 4-38 | Control and Diagnostic Register 2 Description | 80 |
| 4-39 | Subsystem Access Register Description..... | 81 |
| 4-40 | General Control Register Description | 81 |
| 4-41 | Arbiter Control Register Description | 85 |
| 4-42 | Arbiter Request Mask Register Description | 86 |
| 4-43 | Arbiter Time-Out Status Register Description | 86 |
| 5-1 | PCI Express Extended Configuration Register Map..... | 89 |
| 5-2 | Uncorrectable Error Status Register Description | 91 |
| 5-3 | Uncorrectable Error Mask Register Description..... | 92 |
| 5-4 | Uncorrectable Error Severity Register Description | 93 |
| 5-5 | Correctable Error Status Register Description | 94 |
| 5-6 | Correctable Error Mask Register Description | 95 |
| 5-7 | Advanced Error Capabilities and Control Register Description | 96 |
| 5-8 | Secondary Uncorrectable Error Status Register Description..... | 97 |
| 5-9 | Secondary Uncorrectable Error Mask Register Description..... | 98 |
| 5-10 | Secondary Uncorrectable Error Severity Register Description | 99 |
| 5-11 | Secondary Error Capabilities and Control Register Description..... | 100 |
| 5-12 | Secondary Header Log Register Description | 101 |
| 6-1 | Device Control Memory Window Register Map | 102 |
| 6-2 | GPIO Control Register Description..... | 103 |
| 6-3 | GPIO Data Register Description..... | 104 |
| 6-4 | Serial-Bus Slave Address Register Descriptions | 105 |
| 6-5 | Serial-Bus Control and Status Register Description | 106 |
| 7-1 | 1394 OHCI Configuration Register Map..... | 107 |
| 7-2 | Command Register Description..... | 108 |
| 7-3 | Status Register Description | 109 |

XIO2213A PCI Express to 1394b OHCI with 3-Port PHY

SCPS183A–OCTOBER 2007–REVISED MARCH 2008

www.ti.com

| | | |
|------|--|---------------------|
| 7-4 | Class Code and Revision ID Register Description | 110 |
| 7-5 | Latency Timer and Class Cache Line Size Register Description | 111 |
| 7-6 | Header Type and BIST Register Description | 111 |
| 7-7 | OHCI Base Address Register Description..... | 112 |
| 7-8 | TI Base Address Register Description | 112 |
| 7-9 | Subsystem Identification Register Description..... | 113 |
| 7-10 | Interrupt Line and Pin Registers Description..... | 114 |
| 7-11 | MIN_GNT and MAX_LAT Register Description | 115 |
| 7-12 | OHCI Control Register Descriptioni | 115 |
| 7-13 | Capability ID and Next Item Pointer Registers Description | 115 |
| 7-14 | Interrupt Line and Pin Registers Description..... | 116 |
| 7-15 | Power Management Control and Status Register Description | 116 |
| 7-16 | Power Management Extension Registers Description..... | 117 |
| 7-17 | Miscellaneous Configuration Register | 118 |
| 7-18 | Link Enhancement Control Register Description | 120 |
| 7-19 | Subsystem Access Register Description | 121 |
| 8-1 | OHCI Register Map | 122 |
| 8-2 | OHCI Version Register Description | 124 |
| 8-3 | GUID ROM Register Description | 125 |
| 8-4 | Asynchronous Transmit Retries Register Description | 126 |
| 8-5 | CSR Control Register Description..... | 127 |
| 8-6 | Configuration ROM Header Register Description | 128 |
| 8-7 | Bus Options Register Description | 128 |
| 8-8 | Configuration ROM Mapping Register Description..... | 130 |
| 8-9 | Posted Write Address Low Register Description | 131 |
| 8-10 | Posted Write Address High Register Description | 131 |
| 8-11 | Host Controller Control Register Description | 132 |
| 8-12 | Self-ID Count Register Description..... | 133 |
| 8-13 | Isochronous Receive Channel Mask High Register Description | 134 |
| 8-14 | Isochronous Receive Channel Mask Low Register Description..... | 135 |
| 8-15 | Interrupt Event Register Description | 135 |
| 8-16 | Interrupt Mask Register Description..... | 137 |
| 8-17 | Isochronous Transmit Interrupt Event Register Description | 139 |
| 8-18 | Isochronous Receive Interrupt Event Register Description | 140 |
| 8-19 | Initial Bandwidth Available Register Description | 141 |
| 8-20 | Initial Channels Available High Register Description | 141 |
| 8-21 | Initial Channels Available Low Register Description | 142 |
| 8-22 | Fairness Control Register Description | 143 |
| 8-23 | Link Control Register Description | 144 |
| 8-24 | Node Identification Register Description..... | 145 |
| 8-25 | PHY Control Register Description | 146 |

| | | |
|------|---|---------------------|
| 8-26 | Isochronous Cycle Timer Register Description | 147 |
| 8-27 | Asynchronous Request Filter High Register Description | 148 |
| 8-28 | Asynchronous Request Filter Low Register Description | 150 |
| 8-29 | Physical Request Filter High Register Description | 151 |
| 8-30 | Physical Request Filter Low Register Description | 153 |
| 8-31 | Asynchronous Context Control Register Description | 154 |
| 8-32 | Asynchronous Context Command Pointer Register Description | 155 |
| 8-33 | Isochronous Transmit Context Control Register Description | 156 |
| 8-34 | Isochronous Receive Context Control Register Description | 157 |
| 8-35 | Isochronous Receive Context Match Register Description | 159 |
| 9-1 | TI Extension Register Map | 160 |
| 9-2 | Isochronous Receive Digital Video Enhancements Register Description | 161 |
| 9-3 | Link Enhancement Register Description..... | 162 |
| 9-4 | Timestamp Offset Register Description..... | 164 |
| 10-1 | Base Register Description..... | 167 |
| 10-2 | Base Register Field Description | 167 |
| 10-3 | Page-0 (Port Status) Register Description | 169 |
| 10-4 | Page-0 (Port Status) Register Field Description..... | 169 |
| 10-5 | Page 1 (Vendor ID) Register Configuration | 171 |
| 10-6 | Page 1 (Vendor ID) Register Field Descriptions..... | 171 |
| 10-7 | Page 7 (Vendor Dependant) Register Configuration | 171 |
| 10-8 | Page 7 (Vendor Dependant) Register Field Descriptions | 172 |
| 10-9 | Register Description..... | 172 |

1 Introduction

1.1 XIO2213A Features

- Full x1 PCI Express Throughput
- Fully Compliant with *PCI Express Base Specification*, Revision 1.1
- Utilizes 100-MHz Differential PCI Express Common Reference Clock or 125-MHz Single-Ended Reference Clock
- Fully supports provisions of IEEE P1394b-2002
- Fully Compliant With Provisions of IEEE Std 1394-1995 for a High-Performance Serial Bus and IEEE Std 1394a-2000
- Fully Compliant with *1394 Open Host Controller Interface Specification*, Revision 1.1 and Revision 1.2 draft
- Three IEEE Std 1394b Fully Compliant Cable Ports at 100M Bits/s, 200M Bits/s, 400M Bits/s, and 800M Bits/s
- Cable Ports Monitor Line Conditions for Active Connection To Remote Node
- Cable Power Presence Monitoring
- EEPROM Configuration Support to Load the Global Unique ID for the 1394 Fabric
- Support for D1, D2, D3_{hot}
- Active State Link Power Management Saves Power When Packet Activity on the PCI Express™ Link is Idle, Using Both L0s and L1 States
- Eight 3.3-V, Multifunction, General-Purpose I/O Terminals



Please be aware that an important notice concerning availability, standard warranty, and use in critical applications of Texas Instruments semiconductor products and disclaimers thereto appears at the end of this document.

OHCI-Lynx is a trademark of Texas Instruments.
PCI Express is a trademark of PCI-SIG.

2 Overview

The Texas Instruments XIO2213A is a single-function PCI Express™ to PCI local bus translation bridge where the PCI bus interface is internally connected to a 1394b open host controller link-layer controller with a three-port 1394b PHY. When the XIO2213A is properly configured, this solution provides full PCI Express and 1394b functionality and performance.

2.1 Description

The Texas Instruments XIO2213A is a PCI Express to PCI translation bridge where the PCI bus interface is internally connected to a 1394b open host controller link-layer controller with a three-port 1394b PHY. The PCI-Express to PCI translation bridge is fully compatible with the *PCI Express to PCI/PCI-X Bridge Specification*, Revision 1.0. Also, the bridge supports the standard PCI-to-PCI bridge programming model. The 1394b OHCI controller function is fully compatible with IEEE Standard 1394b and the latest *1394 Open Host Controller Interface (OHCI) Specification*.

The XIO2213A simultaneously supports up to four posted write transactions, four non-posted transactions, and four completion transactions pending in each direction at any time. Each posted write data queue and completion data queue can store up to 8K bytes of data. The non-posted data queues can store up to 128 bytes of data.

The PCI Express interface supports a x1 link operating at full 250 MB/s packet throughput in each direction simultaneously. Also, the bridge supports the advanced error reporting capability including ECRC as defined in the *PCI Express Base Specification*, Revision 1.1. Supplemental firmware or software is required to fully utilize both of these features.

Robust pipeline architecture is implemented to minimize system latency. If parity errors are detected, then packet poisoning is supported for both upstream and downstream operations.

The PCIe Power management (PM) features include active state link PM, PME mechanisms, and all conventional PCI D-states. If the active state link PM is enabled, then the link automatically saves power when idle using the L0s and L1 states. PM active state NAK, PM PME, and PME-to-ACK messages are supported. The bridge is compliant with the latest PCI Bus Power Management Specification and provides several low-power modes, which enable the host power system to further reduce power consumption.

Eight general-purpose inputs and outputs (GPIOs), configured through accesses to the PCI Express configuration space, allow for further system control and customization.

Deep FIFOs are provided to buffer 1394 data and accommodate large host bus latencies. The device provides physical write posting and a highly tuned physical data path for SBP-2 performance. The device is capable of transferring data between the PCI Express bus and the 1394 bus at 100M bits/s, 200M bits/s, 400M bits/s, and 800M bits/s. The device provides three 1394 ports that have separate cable bias (TPBIAS).

As required by the *1394 Open Host Controller Interface Specification*, internal control registers are memory-mapped and nonprefetchable. This configuration header is accessed through configuration cycles specified by PCI Express, and it provides plug-and-play (PnP) compatibility.

The PHY-layer provides the digital and analog transceiver functions needed to implement a three-port node in a cable-based 1394 network. Each cable port incorporates two differential line transceivers. The transceivers include circuitry to monitor the line conditions as needed for determining connection status, for initialization and arbitration, and for packet reception and transmission. An optional external 2-wire serial EEPROM interface is provided to load the global unique ID for the 1394 fabric.

The XIO2213A requires an external 98.304-MHz crystal oscillator to generate a reference clock. The external clock drives an internal phase-locked loop (PLL), which generates the required reference signal. This reference signal provides the clock signals that control transmission of the outbound encoded information. The power-down (PD) function, when enabled by asserting the PD terminal high, stops operation of the PLL. Data bits to be transmitted through the cable ports are latched internally, combined serially, encoded, and transmitted at 98.304, 196.608, 393.216, 491.52, or 983.04 Mbps (referred to as S100, S200, S400, S400B, or S800 speed, respectively) as the outbound information stream.

To ensure that the XIO2213A conforms to the IEEE Std 1394b-2002 standard, the BMODE terminal must be asserted. The BMODE terminal does not select the cable-interface mode of operation. The BMODE terminal selects the internal PHY section-LLC section interface mode of operation and affects the arbitration modes on the cable. BMODE must be pulled high during normal operation.

Three package terminals are used as inputs to set the default value for three configuration status bits in the self-ID packet. They can be pulled high through a 1-k Ω resistor or hardwired low as a function of the equipment design. The PC0, PC1, and PC2 terminals indicate the default power class status for the node (the need for power from the cable or the ability to supply power to the cable). The contender bit in the PHY register set indicates that the node is a contender either for the isochronous resource manager (IRM) or for the bus manager (BM). On the XIO2213A, this bit can only be set by a write to the PHY register set. If a node is to be a contender for IRM or BM, the node software must set this bit in the PHY register set.

2.2 Related Documents

- *PCI Express to PCI/PCI-X Bridge Specification*, Revision 1.0
- *PCI Express Base Specification*, Revision 1.1
- *PCI Express Card Electromechanical Specification*, Revision 1.1
- *PCI Local Bus Specification*, Revision 2.3 and 3.0
- *PCI-to-PCI Bridge Architecture Specification*, Revision 1.1
- *PCI Bus Power Management Interface Specification*, Revision 1.1 or 1.2
- *1394 Open Host Controller Interface Specification* Release 1.2
- *IEEE Standard for a High Performance Serial Bus* IEEE Std 1394-1995
- *IEEE Standard for a High Performance Serial Bus—Amendment 1* IEEE Std 1394a-2000
- *IEEE Standard for a High Performance Serial Bus—Amendment 2* IEEE Std 1394b-2002
- *Express Card Standard*, Release 1.0 and 1.1
- *PCI Express Jitter and BER White Paper*
- *PCI Mobile Design Guide*, Revision 1.1

2.3 Trademarks

- PCI Express is a trademark of PCI-SIG.
- OHCI-Lynx, and MicroStar BGA are trademarks of Texas Instruments.
- Other trademarks are the property of their respective owners.

2.4 Documents Conventions

Throughout this data manual, several conventions are used to convey information. These conventions are listed below:

1. To identify a binary number or field, a lower case b follows the numbers. For example: 000b is a 3-bit binary field.
2. To identify a hexadecimal number or field, a lower case h follows the numbers. For example: 8AFh is a 12-bit hexadecimal field.
3. All other numbers that appear in this document that do not have either a b or h following the number are assumed to be decimal format.
4. If the signal or terminal name has a bar above the name (for example, \overline{GRST}), then this indicates the logical NOT function. When asserted, this signal is a logic low, 0, or 0b.
5. Differential signal names end with P, N, +, or – designators. The P or + designators signify the positive signal associated with the differential pair. The N or – designators signify the negative signal associated with the differential pair.
6. RSVD indicates that the referenced item is reserved.
7. In Sections 4 through 6, the configuration space for the bridge is defined. For each register bit, the software access method is identified in an access column. The legend for this access column includes the following entries:
 - r – read access by software
 - u – updates by the bridge internal hardware
 - w – write access by software
 - c – clear an asserted bit with a write-back of 1b by software. Write of zero to the field has no effect
 - s – the field may be set by a write of one. Write of zero to the field has no effect
 - na – not accessible or not applicable
8. The XIO2213A consists of a PCI-Express to PCI translation bridge where the secondary PCI bus is internally connected to a 1394b OHCI with a 3-port PHY. When describing functionality that is specific to the PCI-Express to PCI translation bridge, the term bridge is used to reduce text. The term 1394b OHCI is used to reduce text when describing the 1394b OHCI with 3-port PHY function.

9. LLC is used to refer to the 1394 link layer controller.

2.5 Ordering Information

| ORDERING NUMBER | NAME | VOLTAGE | PACKAGE |
|-----------------|--|---------------------------------|-----------------------------------|
| XIO2213AZAY | PCI-Express to PCI Translation Bridge with 1394b OHCI and Three-Port PHY | 3.3-V and 1.5-V power terminals | 167-terminal ZAY (Lead-Free) PBGA |

2.6 Terminal Assignments

The XIO2213A is packaged in a 167-ball ZAY PBGA. For the ZAY BGATable 2-1 lists the terminals sorted alphanumerically. Table 2-2 lists the signals in alphanumerical order.

Table 2-1. XIO2213AZAY_12x12 Terminals Sorted Alphanumerically

| XIO2213A | |
|------------|----------------|
| BGA BALL # | SIGNAL NAME |
| A01 | REFCLK+ |
| A02 | CNA |
| A03 | RXN |
| A04 | RXP |
| A05 | BMODE |
| A06 | TESTW(VREG_PD) |
| A07 | VSS |
| A08 | TXN |
| A09 | TXP |
| A10 | VDDA_33 |
| A11 | PC2 |
| A12 | REF1_PCIE |
| A13 | REF0_PCIE |
| A14 | VSS |
| B01 | REFCLK- |
| B02 | TESTM |
| B03 | PD |
| B04 | PHY_RESET# |
| B05 | VDDA_15 |
| B06 | VSSA |
| B07 | VDDA_15 |
| B08 | VDD_15 |
| B09 | VDDA_15 |
| B10 | VDDA_15 |
| B11 | VDD_33_COMB |
| B12 | VDD_33 |
| B13 | PERST# |
| B14 | TPA2+ |
| C01 | LPS_L |
| C02 | LPS_P |
| C03 | VDDA_33 |
| C04 | VSSA_PCIE |
| C05 | VSSA_PCIE |
| C06 | VSSA_PCIE |
| C07 | VSSA_PCIE |
| C08 | DVDD_3.3 |
| C09 | DVDD_CORE |
| C10 | VSSA |
| C11 | VDD_33_COM_IO |
| C12 | VDD_15_COMB |
| C13 | GRST# |
| C14 | TPA2- |
| D01 | LKON/DS2_P |
| D02 | PINT_L |
| D03 | PINT_P |
| D12 | RSVD |
| D13 | RSVD |
| D14 | TPB2+ |
| E01 | LINKON_L |

| XIO2213A | |
|------------|-------------|
| BGA BALL # | SIGNAL NAME |
| E02 | LREQ_P |
| E03 | VDD_33 |
| E06 | GND |
| E07 | GND |
| E08 | PC1 |
| E09 | PC0 |
| E10 | AVDD_3.3 |
| E12 | RSVD |
| E13 | TPBIAS2 |
| E14 | TPB2- |
| F01 | PCLK_P |
| F02 | LREQ_L |
| F03 | DVDD_CORE |
| F05 | VSSA |
| F06 | GND |
| F07 | GND |
| F08 | GND |
| F09 | GND |
| F10 | AVDD_3.3 |
| F12 | RSVD |
| F13 | RSVD |
| F14 | TPA1+ |
| G01 | PCLK_L |
| G02 | LCLK_L |
| G03 | VDD_15 |
| G05 | GND |
| G06 | GND |
| G07 | GND |
| G08 | GND |
| G09 | GND |
| G10 | VDD_33 |
| G12 | RSVD |
| G13 | TPBIAS1 |
| G14 | TPA1- |
| H01 | CTL0 |
| H02 | LCLK_P |
| H03 | VDD_15 |
| H05 | GND |
| H06 | GND |
| H07 | GND |
| H08 | GND |
| H09 | GND |
| H10 | VDD_33 |
| H12 | SDA |
| H13 | REFCLK_SEL |
| H14 | TPB1+ |
| J01 | CTL1 |
| J02 | D0 |
| J03 | DVDD_3.3 |
| J05 | GND |
| J06 | GND |

Table 2-1. XIO2213AZAY_12x12 Terminals Sorted Alphanumerically (continued)

| XIO2213A | |
|------------|-------------|
| BGA BALL # | SIGNAL NAME |
| J07 | GND |
| J08 | GND |
| J09 | AVDD_3.3 |
| J10 | VDD_33 |
| J12 | CLKREQ# |
| J13 | SCL |
| J14 | TPB1- |
| K01 | D2 |
| K02 | D1 |
| K03 | DVDD_3.3 |
| K05 | GND |
| K06 | GND |
| K07 | GND |
| K08 | GND |
| K09 | AVDD_3.3 |
| K10 | VDD_15 |
| K12 | RSVD |
| K13 | TPBIAS0 |
| K14 | TPA0+ |
| L01 | D3 |
| L02 | D4 |
| L03 | D5 |
| L12 | RSVD |
| L13 | RSVD |
| L14 | TPA0- |
| M01 | R1 |
| M02 | D6 |
| M03 | D7 |
| M04 | AVDD_3.3 |
| M05 | VDD_33 |
| M06 | VDD_15 |
| M07 | PLLVDV_CORE |

| XIO2213A | |
|------------|-------------|
| BGA BALL # | SIGNAL NAME |
| M08 | RSVD |
| M09 | DVDD_CORE |
| M10 | AVDD_3.3 |
| M11 | RSVD |
| M12 | RSVD |
| M13 | RSVD |
| M14 | TPB0+ |
| N01 | R0 |
| N02 | GPIO1 |
| N03 | GPIO3 |
| N04 | GPIO4 |
| N05 | PLLGNV |
| N06 | GPIO7 |
| N07 | PLLVDV_3.3 |
| N08 | CYCLEOUT |
| N09 | DS0 |
| N10 | RSVD |
| N11 | RSVD |
| N12 | RSVD |
| N13 | RSVD |
| N14 | TPB0- |
| P01 | GPIO0 |
| P02 | GPIO2 |
| P03 | RSVD |
| P04 | XI |
| P05 | GPIO5 |
| P06 | GPIO6 |
| P07 | VDD_15 |
| P08 | OHCL_PME# |
| P09 | DS1 |
| P10 | RSVD |
| P11 | RSVD |
| P12 | CPS |
| P13 | SE |
| P14 | SM |

Table 2-2. XIO2213AZAY_12x12 Signals Sorted Alphanumerically

| XIO2213A | |
|------------|-------------|
| BGA BALL # | SIGNAL NAME |
| E10 | AVDD_3.3 |
| F10 | AVDD_3.3 |
| J09 | AVDD_3.3 |
| K09 | AVDD_3.3 |
| M10 | AVDD_3.3 |
| M04 | AVDD_3.3 |
| A05 | BMODE |
| J12 | CLKREQ# |
| A02 | CNA |
| P12 | CPS |
| H01 | CTL0 |
| J01 | CTL1 |
| N08 | CYCLEOUT |
| J02 | D0 |
| K02 | D1 |
| K01 | D2 |
| L01 | D3 |
| L02 | D4 |
| L03 | D5 |
| M02 | D6 |
| M03 | D7 |
| N09 | DS0 |
| P09 | DS1 |
| C08 | DVDD_3.3 |
| J03 | DVDD_3.3 |
| K03 | DVDD_3.3 |
| C09 | DVDD_CORE |
| F03 | DVDD_CORE |
| M09 | DVDD_CORE |
| E06 | GND |
| E07 | GND |
| F06 | GND |
| F07 | GND |
| F08 | GND |
| F09 | GND |
| G05 | GND |
| G06 | GND |
| G07 | GND |
| G08 | GND |
| G09 | GND |
| H05 | GND |
| H06 | GND |
| H07 | GND |
| H08 | GND |
| H09 | GND |

| XIO2213A | |
|------------|-------------|
| BGA BALL # | SIGNAL NAME |
| J05 | GND |
| J06 | GND |
| J07 | GND |
| J08 | GND |
| K05 | GND |
| K06 | GND |
| K07 | GND |
| K08 | GND |
| P01 | GPIO0 |
| N02 | GPIO1 |
| P02 | GPIO2 |
| N03 | GPIO3 |
| N04 | GPIO4 |
| P05 | GPIO5 |
| P06 | GPIO6 |
| N06 | GPIO7 |
| C13 | GRST# |
| G02 | LCLK_L |
| H02 | LCLK_P |
| E01 | LINKON_L |
| D01 | LKON/DS2_P |
| C01 | LPS_L |
| C02 | LPS_P |
| F02 | LREQ_L |
| E02 | LREQ_P |
| P08 | OHCI_PME# |
| E09 | PC0 |
| E08 | PC1 |
| A11 | PC2 |
| G01 | PCLK_L |
| F01 | PCLK_P |
| B03 | PD |
| B13 | PERST# |
| D02 | PINT_L |
| D03 | PINT_P |
| N05 | PLLGND |
| N07 | PLLVD_3.3 |
| M07 | PLLVD_CORE |
| N01 | R0 |
| M01 | R1 |
| A13 | REF0_PCIE |
| A12 | REF1_PCIE |
| B01 | REFCLK- |
| H13 | REFCLK_SEL |
| A01 | REFCLK+ |
| B04 | PHY_RESET# |
| G12 | RSVD |

Table 2-2. XIO2213AZAY_12x12 Signals Sorted Alphanumerically (continued)

| XIO2213A | |
|------------|----------------|
| BGA BALL # | SIGNAL NAME |
| F13 | RSVD |
| F12 | RSVD |
| E12 | RSVD |
| D12 | RSVD |
| D13 | RSVD |
| M08 | RSVD |
| N10 | RSVD |
| P10 | RSVD |
| P11 | RSVD |
| N11 | RSVD |
| M11 | RSVD |
| N12 | RSVD |
| N13 | RSVD |
| M12 | RSVD |
| M13 | RSVD |
| L13 | RSVD |
| K12 | RSVD |
| L12 | RSVD |
| A03 | RXN |
| A04 | RXP |
| J13 | SCL |
| H12 | SDA |
| P13 | SE |
| P14 | SM |
| B02 | TESTM |
| A06 | TESTW(VREG_PD) |
| L14 | TPA0- |
| K14 | TPA0+ |
| G14 | TPA1- |
| F14 | TPA1+ |
| C14 | TPA2- |
| B14 | TPA2+ |
| N14 | TPB0- |
| M14 | TPB0+ |
| J14 | TPB1- |
| H14 | TPB1+ |

| XIO2213A | |
|------------|---------------|
| BGA BALL # | SIGNAL NAME |
| E14 | TPB2- |
| D14 | TPB2+ |
| K13 | TPBIAS0 |
| G13 | TPBIAS1 |
| E13 | TPBIAS2 |
| A08 | TXN |
| A09 | TXP |
| G03 | VDD_15 |
| H03 | VDD_15 |
| K10 | VDD_15 |
| M06 | VDD_15 |
| B08 | VDD_15 |
| C12 | VDD_15_COMB |
| E03 | VDD_33 |
| G10 | VDD_33 |
| H10 | VDD_33 |
| J10 | VDD_33 |
| M05 | VDD_33 |
| B12 | VDD_33 |
| C11 | VDD_33_COM_IO |
| B11 | VDD_33_COMB |
| B10 | VDDA_15 |
| B09 | VDDA_15 |
| B07 | VDDA_15 |
| B05 | VDDA_15 |
| C03 | VDDA_33 |
| A10 | VDDA_33 |
| P07 | VDD_15 |
| A14 | VSS |
| A07 | VSS |
| F05 | VSSA |
| C10 | VSSA |
| B06 | VSSA |
| C04 | VSSA_PCIE |
| C05 | VSSA_PCIE |
| C06 | VSSA_PCIE |
| C07 | VSSA_PCIE |
| P04 | XI |
| P03 | RSVD |

2.7 Terminal Descriptions

The following tables give a description of the terminals. These terminals are grouped in tables by functionality. Each table includes the terminal name, terminal number, I/O type, and terminal description.

The following list describes the different input/output cell types that appear in the terminal description tables:

- HS DIFF IN = High speed differential input
- HS DIFF OUT = High speed differential output

XIO2213A PCI Express to 1394b OHCI with 3-Port PHY

SCPS183A–OCTOBER 2007–REVISED MARCH 2008

www.ti.com

- LV CMOS = 3.3-V low voltage CMOS input or output with 3.3-V clamp rail
- BIAS = Input/output terminals that generate a bias voltage to determine a driver's operating current
- Feed through = these terminals connect directly to macros within the part and not through an input or output cell.
- PWR = Power terminal
- GND = Ground terminal

Table 2-3. Power Supply Terminals

| SIGNAL | BALL 12x12 ZAY | I/O TYPE | EXTERNAL PARTS | DESCRIPTION |
|---------------------------|----------------------------|----------|-------------------|---|
| V _{DD_15} | G03 H03 K10 M06 B08 P07 | PWR | Bypass capacitors | 1.5-V digital core power terminals for the link. |
| V _{DDA_15} | B10 B09 B07 B05 | PWR | Filter | 1.5-V analog power terminal for the link. |
| V _{DD_33} | E03 M05 J10 H10 G10 | PWR | Bypass capacitors | 3.3-V digital I/O power terminals for the link |
| V _{DD_33_AUX} | B12 | | | This terminal is connected to VSS through a pull-down resistor since the XIO2213A does not support Auxiliary power |
| V _{DDA_33} | C03 A10 | PWR | Filter | 3.3-V analog power terminals for the link. This supply terminal is separated from the other power terminals internal to the device to provide noise isolation. |
| DVDD_CORE | C09 F03 M09 | PWR | Bypass capacitors | Digital 1.95-V circuit power for the PHY. A combination of high-frequency decoupling capacitors near each terminal is suggested, such as paralleled 0.1- μ F and 0.001- μ F. An additional 1- μ F capacitor is required for voltage regulation. These supply terminals are separated from the other power terminals internal to the device to provide noise isolation. |
| PLLVDV_CORE | M07 | PWR | Bypass capacitors | PLL 1.95-V circuit power for the PHY. A combination of high-frequency decoupling capacitors near each terminal is suggested, such as paralleled 0.1- μ F and 0.001- μ F. An additional 1- μ F capacitor is required for voltage regulation, and the PLLVDV_CORE terminals must be separate from the DVDD_CORE terminals. These supply terminals are separated from the other power terminals internal to the device to provide noise isolation. |
| DVDD_33 | C08 J03 K03 | PWR | Bypass capacitors | 3.3-V digital I/O power terminals for the PHY |
| AVDD_33 | M04 E10 F10 J09 K09 M10 | PWR | Filter | 3.3-V analog power terminals for the PHY |
| PLLVDV_33 | N07 | PWR | Bypass capacitors | PLL 3.3-V circuit power for the PHY. This supply terminal is separated from the other power terminals internal to the device to provide noise isolation. The PLLVDV_33 and V _{DDA_33} pins should be connected together with a low-dc-impedance connection on the circuit board. |
| V _{DD_15_COMB} | C12 | PWR | Bypass capacitors | Internal 1.5-V main power output for external bypass capacitor filtering. Caution: Do not use this terminal to supply external power to other devices. |
| V _{DD_33_COMB} | B11 | PWR | Bypass capacitors | Internal 3.3-V main power output for external bypass capacitor filtering. Caution: Do not use this terminal to supply external power to other devices. |
| V _{DD_33_COMBIO} | C11 | PWR | Bypass capacitors | Internal 3.3-V I/O power output for external bypass capacitor filtering. Caution: Do not use this terminal to supply external power to other devices. |

Table 2-4. Ground Terminals

| SIGNAL | BALL 12x12 ZAY | I/O TYPE | DESCRIPTION |
|-----------------------|---|----------|---|
| V _{SS} | A07 A14 | GND | Digital ground terminals for link |
| V _{SSA} | B06 C10 F05 | GND | Analog ground terminals for link |
| V _{SSA_PCIE} | C04 C05 C06 C07 | GND | Analog ground terminals for PCI Express function |
| PLLGND | N05 | GND | PLL circuit ground. This terminal must be tied to the low-impedance circuit-board ground plane. |
| GND | E06 E07 F06 F07 F08 F09 G05 G06 G07 G08 G09 H05 H06 H07 H08 H09 J05 J06 J07 J08 K05 K06 K07 K08 | GND | Ground. These terminals must be tied together to the low-impedance circuit-board ground plane. |

Table 2-5. PCI Express Terminals

| SIGNAL | BALL 12x12 ZAY | I/O TYPE | EXTERNAL PARTS | DESCRIPTION |
|---------------------------|----------------|----------|-------------------|---|
| $\overline{\text{PERST}}$ | B13 | I | — | PCI Express reset input. The $\overline{\text{PERST}}$ signal identifies when the system power is stable and generates an internal power-on reset. Note: The $\overline{\text{PERST}}$ input buffer has hysteresis. |
| REF0_PCIE REF1_PCIE | A13 A12 | I/O | External resistor | External reference resistor + and – terminals for setting TX driver current. An external resistor is connected between terminals REF0_PCIE and REF1_PCIE. |
| RXP RXN | A04 A03 | DI | — | High-speed receive pair. RXP and RXN comprise the differential receive pair for the single PCI Express lane supported. |
| TXP TXN | A09 A08 | DO | Series capacitors | High-speed transmit pair. TXP and TXN comprise the differential transmit pair for the single PCI Express lane supported. |

Table 2-6. Clock Terminals

| SIGNAL | BALL 12x12 ZAY | I/O TYPE | EXTERNAL PARTS | DESCRIPTION |
|----------------------------|----------------|----------|---|---|
| REFCLK_SEL | H13 | I | Pullup or pulldown resistor | Reference clock select. This terminal selects the reference clock input. 0 = 100-MHz differential common reference clock used 1 = 125-MHz single-ended reference clock used |
| REFCLK+ | A01 | DI | — | Reference clock. REFCLK+ and REFCLK– comprise the differential input pair for the 100-MHz system reference clock. For a single-ended, 125-MHz system reference clock, use the REFCLK+ input. |
| REFCLK– | B01 | DI | Capacitor to V_{SS} for single-ended mode | Reference clock. REFCLK+ and REFCLK– comprise the differential input pair for the 100-MHz system reference clock. For a single-ended, 125-MHz system reference clock, attach a capacitor from REFCLK– to V_{SS} . |
| $\overline{\text{CLKREQ}}$ | J12 | O | | Clock Request. This terminal is used to support the clock request protocol. |
| XI | P04 | I | | Oscillator input. This terminal connects to a 98.304-MHz low-jitter external oscillator. XI is a 1.8-V CMOS input. Oscillator jitter must be 5-ps RMS or better. If only 3.3-V oscillators can be acquired, great care must be taken to not introduce significant jitter by the means used to level shift from 3.3 V to 1.8 V. If a resistor divider is used, a high-current oscillator and low-value resistors must be used to minimize RC time constants. |

Table 2-7. 1394 Terminals

| SIGNAL | BALL 12x12 ZAY | I/O TYPE | DESCRIPTION |
|-------------------|-------------------|----------|---|
| CNA | A02 | I/O | Cable not active. This terminal is asserted high when there are no ports receiving incoming bias voltage. If it is not used, then this terminal should be left unconnected. |
| CPS | P12 | I | Cable power status input. This terminal is normally connected to cable power through a 400-k Ω resistor. This circuit drives an internal comparator that detects the presence of cable power. If CPS is not used to detect cable power, then this terminal must be connected to V_{SSA} . |
| DS0 | N09 | I | Data-strobe-only mode for port 0. IEEE Std 1394a-2000-only port-0-enable programming terminal. On hardware reset, this terminal allows the user to select whether port 0 acts like an IEEE Std 1394b-2002 bilingual port (terminal at logic 0) or as an IEEE Std 1394a-2000-only port (terminal at logic 1). Programming is accomplished by tying the terminal low through a 1-k Ω or smaller resistor (to enable IEEE Std 1394b-2002 bilingual mode) or high through a 10-k Ω or smaller resistor (to enable IEEE Std 1394a-2000-only mode). |
| DS1 | P09 | I | Data-strobe-only mode for port 1. IEEE Std 1394a-2000-only port-1-enable programming terminal. On hardware reset, this terminal allows the user to select whether port 1 acts like an IEEE Std 1394b-2002 bilingual port (terminal at logic 0) or as an IEEE Std 1394a-2000-only port (terminal at logic 1). Programming is accomplished by tying the terminal low through a 1-k Ω or smaller resistor (to enable IEEE Std 1394b-2002 bilingual mode) or high through a 10-k Ω or smaller resistor (to enable IEEE Std 1394a-2000-only mode). |
| PC0 PC1 PC2 | E09 E08 A11 | I | Power class programming. On hardware reset, these inputs set the default value of the power class indicated during self-ID. Programming is done by tying the terminals high through a 1-k Ω or smaller resistor or by tying directly to ground through a 1-k Ω or smaller resistor. Bus holders are built into these terminals. |

Table 2-7. 1394 Terminals (continued)

| SIGNAL | BALL 12x12 ZAY | I/O TYPE | DESCRIPTION |
|----------------------------------|--------------------------|-------------|---|
| R0 R1 | N01 M01 | I/O | Current-setting resistor terminals. These terminals are connected to an external resistance to set the internal operating currents and cable driver output currents. A resistance of 6.34 k Ω \pm 1% is required to meet the IEEE Std 1394-1995 output voltage limits. |
| TPA0P TPA0N TPB0P TPB0N | K14 L14 M14 N14 | I/O | Port 0 Twisted-pair cable A differential signal terminals. Board trace lengths from each pair of positive and negative differential signal pins must be matched and as short as possible to the external load resistors and to the cable connector. For an unused port, TPA+ and TPA– can be left open. |
| TPA1P TPA1N TPB1P TPB1N | F14 G14 H14 J14 | I/O | Port 1 Twisted-pair cable A differential signal terminals. Board trace lengths from each pair of positive and negative differential signal pins must be matched and as short as possible to the external load resistors and to the cable connector. For an unused port, TPA+ and TPA– can be left open. |
| TPA2P TPA2N TPB2P TPB2N | B14 C14 D14 E14 | I/O | Port 2 Twisted-pair cable A differential signal terminals. Board trace lengths from each pair of positive and negative differential signal pins must be matched and as short as possible to the external load resistors and to the cable connector. For an unused port, TPA+ and TPA– can be left open. |
| TPBIAS0 TPBIAS1 TPBIAS2 | K13 G13 E13 | O | Twisted-pair bias output. This provides the 1.86-V nominal bias voltage needed for proper operation of the twisted-pair cable drivers and receivers, and for signaling to the remote nodes that there is an active cable connection in IEEE Std 1394a-2000 mode. Each of these terminals, except for an unused port, must be decoupled with a 1- μ F capacitor to ground. For the unused port, this terminal can be left unconnected. |
| PCLK_L | G01 | I | PHY-section clock. This terminal must be connected to the PCLK_P output of the PHY section. |
| PCLK_P | F01 | O | PHY-section clock. This terminal must be connected to the PCLK_L input of the LLC section. |
| LCLK_L | G02 | O | LLC-section clock. This terminal must be connected to the LCLK_P input terminal of the PHY section. |
| LCLK_P | H02 | I | LLC-section clock. This terminal must be connected to the LCLK_L output terminal of the LLC section. |
| LPS_L | C01 | O | LLC-section power status. This terminal must be connected to the LPS_P input terminal of the PHY section. |
| LPS_P | C02 | I | Link power status. This terminal must be connected to the LPS_L output terminal of the LLC section. |
| PINT_L | D02 | I | PHY-section interrupt. The PHY section uses this signal to transfer status and interrupt information serially to the LLC section. This terminal must be connected to the PINT_P output of the PHY section. |
| PINT_P | D03 | O | PHY-section interrupt. PINT_P is a serial input to the LLC section from the PHY section that is used to transfer status, register, interrupt, and other information to the link. Information encoded on PINT_P is synchronous to PCLK_P. This terminal must be connected to the PINT_L input of the LLC section. |

Table 2-7. 1394 Terminals (continued)

| SIGNAL | BALL 12x12 ZAY | I/O TYPE | DESCRIPTION |
|--|--|----------|---|
| LKON/DS2_P | D01 | I/O | <p>Link-on notification. If port is to operate in DS mode or is unused then it is necessary to pull the terminal high through a 470-Ω or smaller resistor. This terminal must also be connected to the LINKON_L input terminal of the LLC section via a 1-kΩ series resistor. A bus holder is built into this terminal. If the port is to operate in bi-lingual mode then the terminal should be tied low via a 1-kΩ resistor and directly connected to the link's LINKON_L pin with no series termination. After hardware reset, this terminal is the link-on output, which notifies the LLC section or other power-up logic to power up and become active. The link-on output is a square-wave signal with a period of approximately 163 ns (eight PCLK cycles) when active. The link-on output is otherwise driven low, except during hardware reset when it is high impedance. The link-on output is activated if the LLC section is inactive (the LPS input inactive or the LCtrl bit cleared) and when any of the following occurs:</p> <ul style="list-style-type: none"> a) The XIO2213A receives a link-on PHY packet addressed to this node. b) The PEI (port-event interrupt) register bit is 1. c) Any of the configuration-timeout interrupt (CTOI), cable-power-status interrupt (CPSI), or state-time-out interrupt (STOI) register bits are 1 and the resuming-port interrupt enable (RPIE) register bit also is 1. d) The PHY is power cycled and the power class is 0 through 4. <p>Once activated, the link-on output is active until the LLC section becomes active (both the LPS_L input active and the LCtrl bit set). The PHY section also deasserts the link-on output when a bus reset occurs unless the link-on output is otherwise active because one of the interrupt bits is set (that is, the link-on output is active due solely to the reception of a link-on PHY packet) In the case of power cycling, the LKON signal must stop after 167 ms if the previous conditions have not been met. NOTE: If an interrupt condition exists which otherwise causes the link-on output to be activated if the LLC section were inactive, the link-on output is activated when the LLC section subsequently becomes inactive.</p> |
| LINKON_L | E01 | I/O | <p>Link-on notification. LINKON_L is an input to the LLC section from the PHY section that is used to provide notification that a link-on packet has been received or an event, such as a port connection, has occurred. This I/O only has meaning when LPS is disabled. This includes the D0 (uninitialized), D2, and D3 power states. If LINKON_L becomes active in the D0 (uninitialized), D2, or D3 power state, the XIO2213A device sets bit 15 (PME_STS) in the power-management control and status register in the PCI configuration space at offset 48h. This terminal must be connected to the LKON output terminal of the PHY section.</p> |
| LREQ_L | F02 | O | <p>LLC-section request. The LLC section uses this output to initiate a service request to the PHY section. This terminal must be connected to the LREQ_P input of the PHY section.</p> |
| LREQ_P | E02 | I | <p>LLC-section request. LREQ_P is a serial input from the LLC section to the PHY section used to request packet transmissions, read and write PHY section registers, and to indicate the occurrence of certain link events that are relevant to the PHY section. Information encoded on LREQ_P is synchronous to LCLK_P. This terminal must be connected to the LREQ_L output of the LLC section.</p> |
| PHY_RESET# | B04 | I | <p>Reset for the 1394 PHY logic</p> |
| CTL1 CTL0 | J01 H01 | I/O | <p>Control. CTL[1:0] are bi-directional control bus signals that are used to indicate the phase of operation of the PHY-link interface. Upon a reset of the interface, this bus is driven by the PHY. When driven by the PHY, information on CTL[1:0] is synchronous to PCLK. When driven by the link, information on CTL[1:0] is synchronous to LCLK. If not implemented, these terminals should be left unconnected.</p> |
| D0 D1 D2 D3 D4 D5 D6 D7 | J02 K02 K01 L01 L02 L03 M02 M03 | I/O | <p>Data. D[7:0] comprise a bi-directional data bus that is used to carry 1394 packet data, packet speed, and grant type information between the PHY and the link. Upon a reset of the interface, this bus is driven by the PHY. When driven by the PHY, information on D[7:0] is synchronous to PCLK. When driven by the link, information on D[7:0] is synchronous to LCLK. If not implemented, these terminals should be left unconnected.</p> |

Table 2-8. Reserved Terminals

| SIGNAL | BALL 12x12 ZAY | I/O TYPE | DESCRIPTION |
|--------|--|----------|---|
| RSVD | E12 F12 F13 K12 L12 L13 M11 M12 M13 N10 N11 N12 N13 P03 P10 P11 | I/O | Reserved, do not connect to external signals. |
| RSVD | D12 D13 G12 M08 | I | Must be connected to V_{SS} . |

Table 2-9. Miscellaneous Terminals

| SIGNAL | BALL 12x12 ZAY | I/O TYPE | DESCRIPTION |
|-----------|----------------|----------|---|
| GPIO0 | P01 | I/O | General-purpose I/O 0. This terminal functions as a GPIO controlled by bit 0 (GPIO0_DIR) in the GPIO control register (see Section 4.60). Note: This terminal has an internal active pullup resistor. |
| GPIO1 | N02 | I/O | General-purpose I/O 1. This terminal functions as a GPIO controlled by bit 1 (GPIO1_DIR) in the GPIO control register (see Section 4.60). Note: This terminal has an internal active pullup resistor. |
| GPIO2 | P02 | I/O | General-purpose I/O 2. This terminal functions as a GPIO controlled by bit 2 (GPIO2_DIR) in the GPIO control register (see Section 4.60). Note: This terminal has an internal active pullup resistor. |
| GPIO3 | N03 | I/O | General-purpose I/O 3. This terminal functions as a GPIO controlled by bit 3 (GPIO3_DIR) in the GPIO control register (see Section 4.60). Note: This terminal has an internal active pullup resistor. |
| GPIO4 | N04 | I/O | General-purpose I/O 4. This terminal functions as a GPIO controlled by bit 4 (GPIO4_DIR) in the GPIO control register (see Section 4.60). Note: This terminal has an internal active pullup resistor. |
| GPIO5 | P05 | I/O | General-purpose I/O 5. This terminal functions as a GPIO controlled by bit 5 (GPIO5_DIR) in the GPIO control register (see Section 4.60). Note: This terminal has an internal active pullup resistor. |
| GPIO6 | P06 | I/O | General-purpose I/O 6. This terminal functions as a GPIO controlled by bit 6 (GPIO6_DIR) in the GPIO control register (see Section 4.60). Note: This terminal has an internal active pullup resistor. |
| GPIO7 | N06 | I/O | General-purpose I/O 7. This terminal functions as a GPIO controlled by bit 7 (GPIO7_DIR) in the GPIO control register (see Section 4.60). Note: This terminal has an internal active pullup resistor. |
| OHCI_PME# | P08 | O | The Power Management Event signal is an optional signal that can be used by a device to request a change in the device or system power state. This signal must be enabled by software. |
| CYCLEOUT | N08 | O | This terminal provides an 8-kHz cycle timer synchronization signal. If not implemented, this terminal should be left unconnected. |
| PD | B03 | I | Power down. A high on this terminal turns off all internal circuitry, except the cable-active monitor circuits that control the CNA output. Asserting PD high also activates an internal pulldown to force a reset of the internal control logic. If PD is not used, then this terminal must be connected to V_{SS} . |
| GRST | C13 | I | Global power reset. This reset brings all of the XIO2213A internal link registers to their default states. This should be a one time power on reset. This terminal has hysteresis and an integrated pull up resistor |
| SCL | J13 | I/O | Serial-bus clock. This pin is used as Serial Bus Clock when a pull-up is detected on SDA or when the SBDETECT bit is set in the Serial Bus Control and Status Register. Note: This terminal has an internal active pullup resistor. |
| SDA | H12 | I/O | Serial-bus data. This pin is used as Serial Bus Data when a pull-up is detected on SDA or when the SBDETECT bit is set in the Serial Bus Control and Status Register. Note: In serial-bus mode, an external pullup resistor is required to prevent the SDA signal from floating. |

Table 2-9. Miscellaneous Terminals (continued)

| SIGNAL | BALL 12x12 ZAY | I/O TYPE | DESCRIPTION |
|--------|----------------|----------|--|
| BMODE | A05 | I | Beta mode. This terminal determines the PHY section-LLC section interface connection protocol. When logic-high (asserted), the PHY section-LLC section interface complies with the IEEE Std 1394b-2002 revision 1.33 Beta interface. When logic low (deasserted), the PHY section-LLC section interface complies with the legacy IEEE Std 1394a-2000 standard. This terminal must be pulled high with a 1-k Ω resistor during normal operation. |
| TESTM | B02 | I | Test control. This input is used in the manufacturing test of the XIO2213A. For normal use, this terminal must be pulled high through a 1-k Ω resistor to V _{DD} . |
| TESTW | A06 | I | Test control. This input is used in the manufacturing test of the XIO2213A. For normal use, this terminal must be pulled high through a 1-k Ω resistor to V _{DD} . |
| SE | P13 | I | Test control. This input is used in the manufacturing test of the XIO2213A. For normal use, this terminal must be pulled low either through a 1-k Ω resistor to GND or directly to GND. |
| SM | P14 | I | Test control. This input is used in the manufacturing test of the XIO2213A. For normal use, this terminal must be pulled low either through a 1-k Ω resistor to GND or directly to GND. |

3 Feature/Protocol Descriptions

This chapter provides a high-level overview of all significant device features. Figure 3-1 shows a simplified block diagram of the basic architecture of the PCI-Express to PCI Bridge with 1394b OHCI and three-port PHY. The top of the diagram is the PCI Express interface and the 1394b OHCI with three-port PHY is located at the bottom of the diagram.

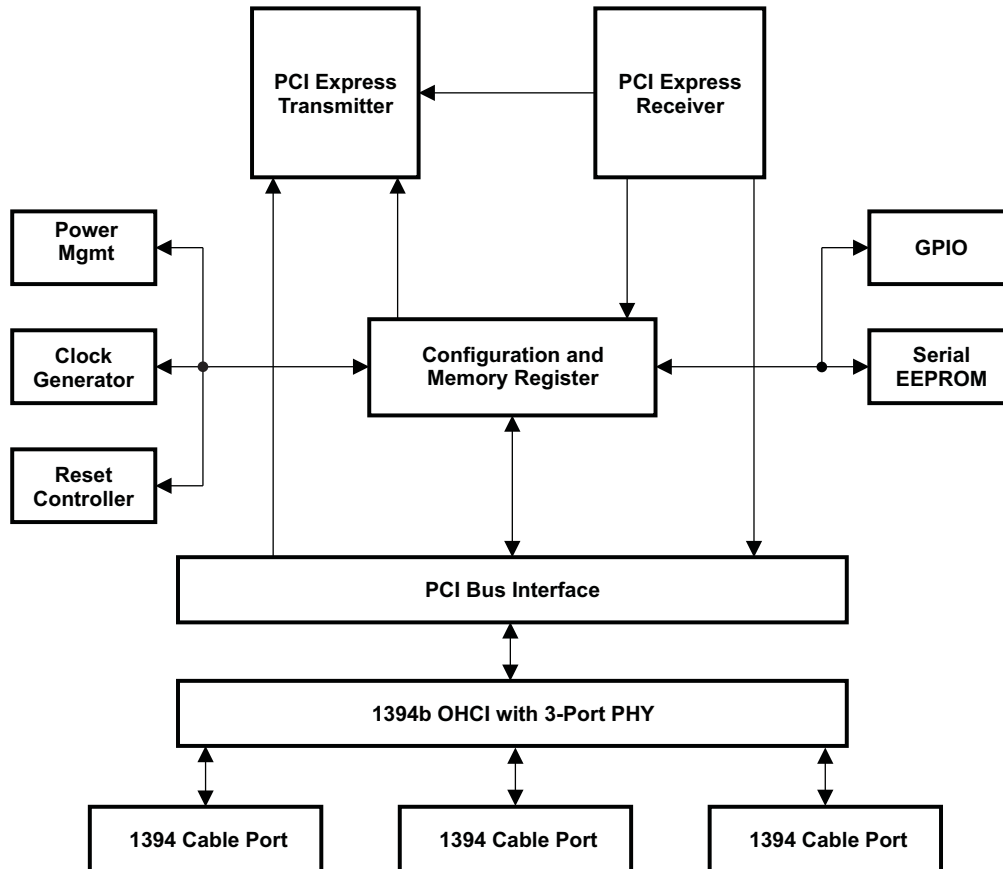

Figure 3-1. XIO2213A Block Diagram

3.1 Power-Up/-Down Sequencing

The bridge contains both 1.5-V and 3.3-V power terminals. The following power-up and power-down sequences describe how power is applied to these terminals.

In addition, the bridge has three resets: $\overline{\text{PERST}}$, $\overline{\text{GRST}}$ and an internal power-on reset. These resets are fully described in Section 3.2. The following power-up and power-down sequences describe how $\overline{\text{PERST}}$ is applied to the bridge.

The application of the PCI Express reference clock (REFCLK) is important to the power-up/-down sequence and is included in the following power-up and power-down descriptions.

3.1.1 Power-Up Sequence

1. Assert $\overline{\text{PERST}}$ to the device.
2. Apply 1.5-V and 3.3-V voltages.
3. Apply a stable PCI Express reference clock.
4. To meet PCI Express specification requirements, $\overline{\text{PERST}}$ cannot be deasserted until the following two delay requirements are satisfied:
 - Wait a minimum of 100 μs after applying a stable PCI Express reference clock. The 100- μs limit satisfies the requirement for stable device clocks by the deassertion of $\overline{\text{PERST}}$.
 - Wait a minimum of 100 ms after applying power. The 100-ms limit satisfies the requirement for stable power by the deassertion of $\overline{\text{PERST}}$.

See the power-up sequencing diagram in [Figure 3-2](#).

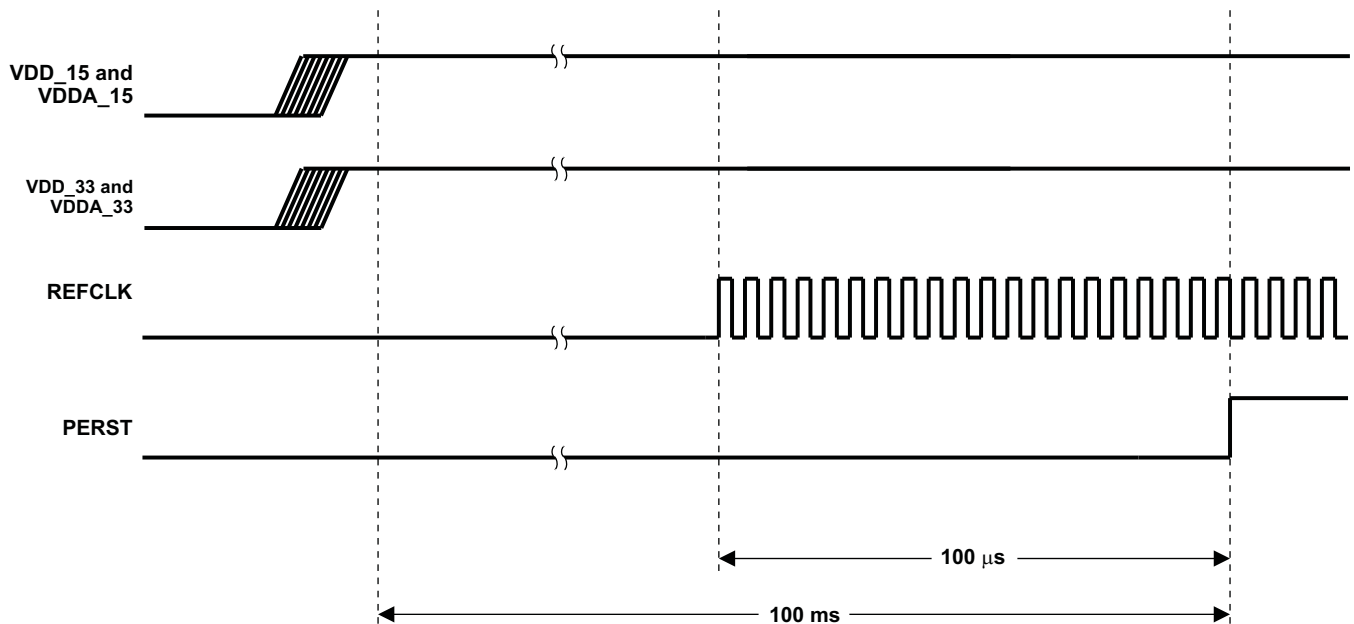

Figure 3-2. Power-Up Sequence

3.1.2 Power-Down Sequence

1. Assert $\overline{\text{PERST}}$ to the device.
2. Remove the reference clock.
3. Remove 3.3-V and 1.5-V voltages.

See the power-down sequencing diagram in [Figure 3-3](#). If the VDD_33_AUX terminal is to remain powered after a system shutdown, then the bridge power-down sequence is exactly the same as shown in [Figure 3-3](#).

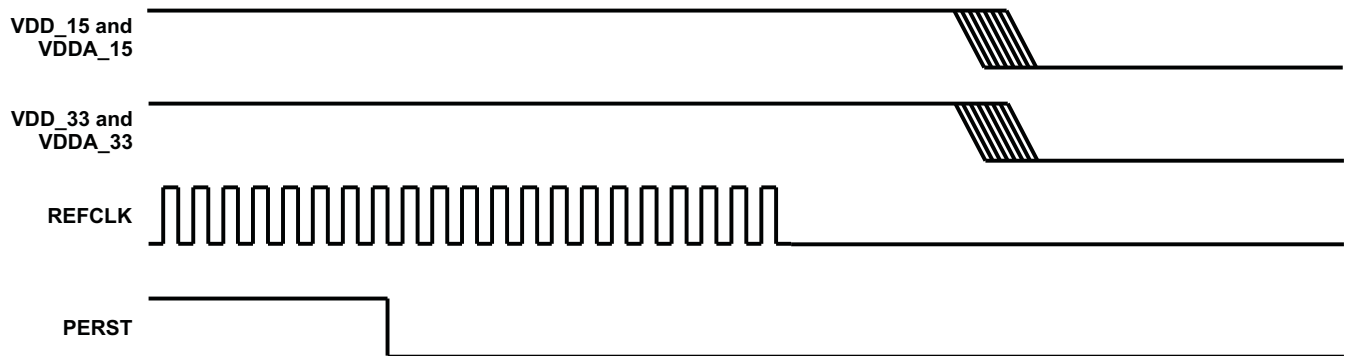

Figure 3-3. Power-Down Sequence

3.2 XIO2213A Reset Features

There are five XIO2213A reset options that include internally-generated power-on reset, resets generated by asserting input terminals, and software-initiated resets that are controlled by sending a PCI Express hot reset or setting a configuration register bit. [Table 3-1](#) identifies these reset sources and describes how the XIO2213A responds to each reset.

Table 3-1. XIO2213A Reset Options

| RESET OPTION | XIO2213A FEATURE | RESET RESPONSE |
|---|--|--|
| XIO2213A internally-generated power-on reset | During a power-on cycle, the XIO2213A asserts an internal reset and monitors the VDD_15_COMB (B11) terminal. When this terminal reaches 90% of the nominal input voltage specification, power is considered stable. After stable power, the XIO2213A monitors the PCI Express reference clock (REFCLK) and waits 10 μs after active clocks are detected. Then, internal power-on reset is deasserted. | When the internal power-on reset is asserted, all control registers, state machines, sticky register bits, and power management state machines are initialized to their default state. In addition, the XIO2213A asserts the internal PCI bus reset. |
| PCI Express reset input $\overline{\text{PERST}}$ (B12) | This XIO2213A input terminal is used by an upstream PCI Express device to generate a PCI Express reset and to signal a system power good condition. When $\overline{\text{PERST}}$ is asserted low, the XIO2213A generates an internal PCI Express reset as defined in the PCI Express specification. When $\overline{\text{PERST}}$ transitions from low to high, a system power good condition is assumed by the XIO2213A. Note: The system must assert $\overline{\text{PERST}}$ before power is removed, before REFCLK is removed or before REFCLK becomes unstable. | When $\overline{\text{PERST}}$ is asserted low, all control register bits that are not sticky are reset. Within the configuration register maps, the sticky bits are indicated by the I symbol. Also, all state machines that are not associated with sticky functionality are reset. In addition, the XIO2213A asserts the internal PCI bus reset. When the rising edge of $\overline{\text{PERST}}$ occurs, the XIO2213A samples the state of all static control inputs and latches the information internally. If an external serial EEPROM is detected, then a download cycle is initiated. Also, the process to configure and initialize the PCI Express link is started. The XIO2213A starts link training within 80 ms after $\overline{\text{PERST}}$ is deasserted. |

Table 3-1. XIO2213A Reset Options (continued)

| RESET OPTION | XIO2213A FEATURE | RESET RESPONSE |
|--|--|---|
| PCI Express training control hot reset | The XIO2213A responds to a training control hot reset received on the PCI Express interface. After a training control hot reset, the PCI Express interface enters the DL_DOWN state. | <p>In the DL_DOWN state, all remaining configuration register bits and state machines are reset. All remaining bits exclude sticky bits and EEPROM loadable bits. All remaining state machines exclude sticky functionality and EEPROM functionality.</p> <p>Within the configuration register maps, the sticky bits are indicated by the I symbol and the EEPROM loadable bits are indicated by the † symbol.</p> <p>In addition, the XIO2213A asserts the internal PCI bus reset.</p> |
| PCI bus reset | System software has the ability to assert and deassert the PCI bus reset on the secondary PCI bus interface. | When bit 6 (SRST) in the XIO2213A control register at offset 3Eh (see Section 4.30) is asserted, the XIO2213A asserts the internal PCI bus reset. A 0b in the SRST bit deasserts the PCI bus reset. |

3.3 PCI Express Interface

3.3.1 External Reference Clock

The XIO2213A requires either a differential, 100-MHz common clock reference or a single-ended, 125-MHz clock reference. The selected clock reference must meet all *PCI Express Electrical Specification* requirements for frequency tolerance, spread spectrum clocking, and signal electrical characteristics.

If the REFCLK_SEL input is connected to V_{SS} , then a differential, 100-MHz common clock reference is expected by the XIO2213A. If the REFCLK_SEL terminal is connected to V_{DD_33} , then a single-ended, 125-MHz clock reference is expected by the XIO2213A.

When the single-ended, 125-MHz clock reference option is enabled, the single-ended clock signal is connected to the REFCLK+ terminal. The REFCLK– terminal is connected to one side of an external capacitor with the other side of the capacitor connected to V_{SS} .

When using a single-ended reference clock, care must be taken to ensure interoperability from a system jitter standpoint. The *PCI Express Base Specification* does not ensure interoperability when using a differential reference clock commonly used in PC applications along with a single-ended clock in a noncommon clock architecture. System jitter budgets will have to be verified to ensure interoperability. See the *PCI Express Jitter and BER White Paper* from the PCI-SIG.

3.3.2 Beacon and Wake

Since the 1394b OHCI function in XIO2213A does not support PME# from D3cold, it is not necessary for the PCI Express to PCI Bridge portion of the design to support Beacon generation or WAKE# signaling. As a result, the XIO2213A does not implement VAUX power support.

3.3.3 Initial Flow Control Credits

The bridge flow control credits are initialized using the rules defined in the *PCI Express Base Specification*. [Table 3-2](#) identifies the initial flow control credit advertisement for the bridge.

Table 3-2. Initial Flow Control Credit Advertisements

| CREDIT TYPE | INITIAL ADVERTISEMENT |
|-----------------------------|-----------------------|
| Posted request headers (PH) | 8 |
| Posted request data (PD) | 128 |
| Nonposted header (NPH) | 4 |
| Nonposted data (NPD) | 4 |
| Completion header (CPLH) | 0 (infinite) |
| Completion data (CPLD) | 0 (infinite) |

3.3.4 PCI Express Message Transactions

PCI Express messages are both initiated and received by the bridge. [Table 3-3](#) outlines message support within the bridge.

Table 3-3. Messages Supported by the Bridge

| MESSAGE | SUPPORTED | BRIDGE ACTION |
|-----------------------------|-----------|------------------------|
| Assert_INTx | Yes | Transmitted upstream |
| Deassert_INTx | Yes | Transmitted upstream |
| PM_Active_State_Nak | Yes | Received and processed |
| PM_PME | Yes | Transmitted upstream |
| PME_Turn_Off | Yes | Received and processed |
| PME_TO_Ack | Yes | Transmitted upstream |
| ERR_COR | Yes | Transmitted upstream |
| ERR_NONFATAL | Yes | Transmitted upstream |
| ERR_FATAL | Yes | Transmitted upstream |
| Set_Slot_Power_Limit | Yes | Received and processed |
| Unlock | No | Discarded |
| Hot plug messages | No | Discarded |
| Advanced switching messages | No | Discarded |
| Vendor defined type 0 | No | Unsupported request |
| Vendor defined type 1 | No | Discarded |

All supported message transactions are processed per the *PCI Express Base Specification*.

3.4 PCI Interrupt Conversion to PCI Express Messages

The bridge converts interrupts from the PCI bus sideband interrupt signals to PCI Express interrupt messages. Since the 1394a OHCI only generates $\overline{\text{INTA}}$ interrupts, only PCI Express INTA messages are generated by the bridge.

PCI Express Assert_INTA messages are generated when the 1394a OHCI signals an $\overline{\text{INTA}}$ interrupt. The requester ID portion of the Assert_INTA message uses the value stored in the primary bus number register (see [Section 4.12](#)) as the bus number, 0 as the device number, and 0 as the function number. The tag field for each Assert_INTA message is 00h.

PCI Express Deassert_INTA messages are generated when the 1394a OHCI deasserts the $\overline{\text{INTA}}$ interrupt. The requester ID portion of the Deassert_INTA message uses the value stored in the primary bus number register as the bus number, 0 as the device number, and 0 as the function number. The Tag field for each Deassert_INTA message is 00h.

[Figure 3-4](#) and [Figure 3-5](#) illustrate the format for both the assert and deassert INTA messages.

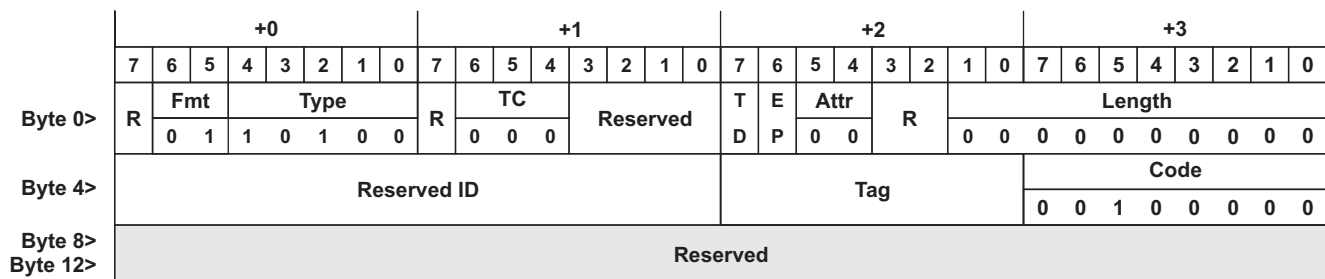

Figure 3-4. PCI Express ASSERT_INTA Message

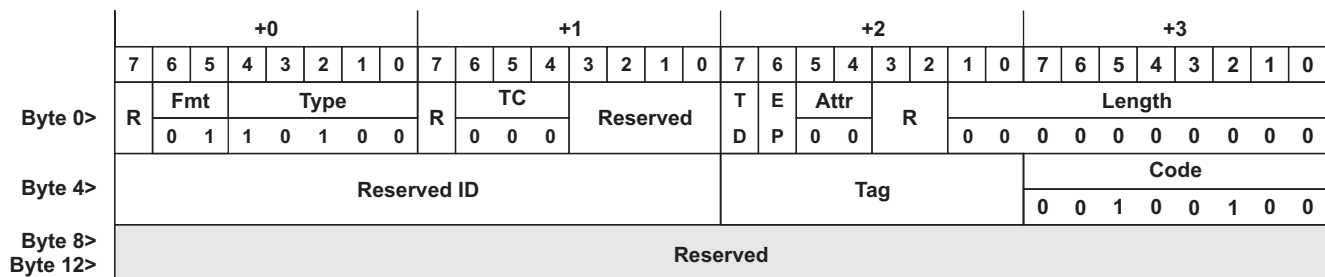

Figure 3-5. PCI Express DEASSERT_INTX Message

3.5 Two-Wire Serial-Bus Interface

The bridge provides a two-wire serial-bus interface to load subsystem identification information and specific register defaults from an external EEPROM. The serial-bus interface signals are SCL and SDA.

3.5.1 Serial-Bus Interface Implementation

To enable the serial-bus interface, a pullup resistor must be implemented on the SDA signal. At the rising edge of $\overline{\text{PERST}}$ or $\overline{\text{GRST}}$, whichever occurs later in time, the SDA terminal is checked for a pullup resistor. If one is detected, then bit 3 (SBDETECT) in the serial-bus control and status register (see [Section 4.59](#)) is set. Software may disable the serial-bus interface at any time by writing a 0b to the SBDETECT bit. If no external EEPROM is required, then the serial-bus interface is permanently disabled by attaching a pulldown resistor to the SDA signal.

The bridge implements a two-terminal serial interface with one clock signal (SCL) and one data signal

(SDA). The SCL signal is a unidirectional output from the bridge and the SDA signal is bidirectional. Both are open-drain signals and require pullup resistors. The bridge is a bus master device and drives SCL at approximately 60 kHz during data transfers and places SCL in a high-impedance state (0 frequency) during bus idle states. The serial EEPROM is a bus slave device and must acknowledge a slave address equal to A0h. [Figure 3-6](#) illustrates an example application implementing the two-wire serial bus.

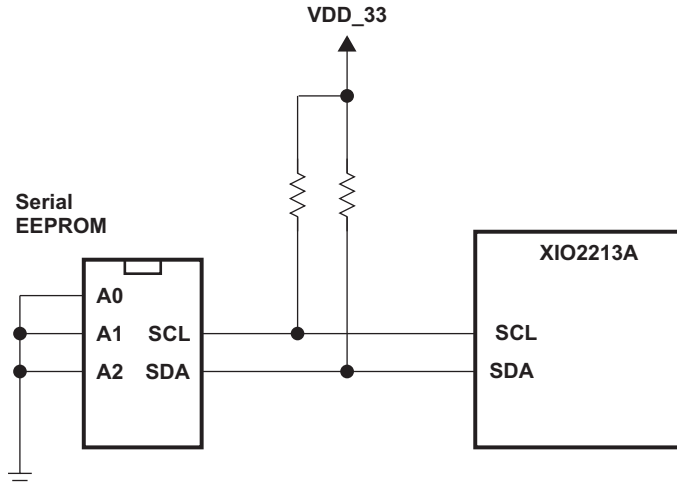

Figure 3-6. Serial EEPROM Application

3.5.2 Serial-Bus Interface Protocol

All data transfers are initiated by the serial-bus master. The beginning of a data transfer is indicated by a start condition, which is signaled when the SDA line transitions to the low state while SCL is in the high state, as illustrated in [Figure 3-7](#). The end of a requested data transfer is indicated by a stop condition, which is signaled by a low-to-high transition of SDA while SCL is in the high state, as shown in [Figure 3-7](#). Data on SDA must remain stable during the high state of the SCL signal, as changes on the SDA signal during the high state of SCL are interpreted as control signals, that is, a start or stop condition.

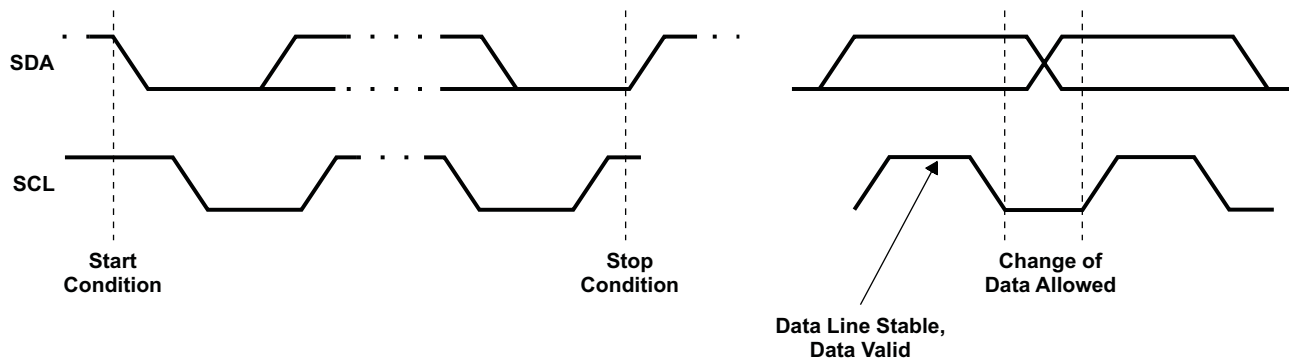

Figure 3-7. Serial-Bus Start/Stop Conditions and Bit Transfers

Data is transferred serially in 8-bit bytes. During a data transfer operation, the exact number of bytes that are transmitted is unlimited. However, each byte must be followed by an acknowledge bit to continue the data transfer operation. An acknowledge (ACK) is indicated by the data byte receiver pulling the SDA signal low, so that it remains low during the high state of the SCL signal. [Figure 3-8](#) illustrates the acknowledge protocol.

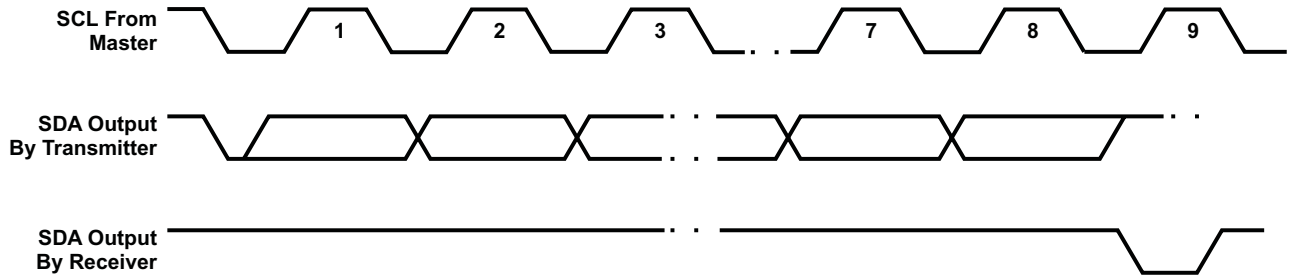

Figure 3-8. Serial-Bus Protocol Acknowledge

The bridge performs three basic serial-bus operations: single byte reads, single byte writes, and multibyte reads. The single byte operations occur under software control. The multibyte read operations are performed by the serial EEPROM initialization circuitry immediately after a PCI Express reset. See Section 3.5.3, *Serial-Bus EEPROM Application*, for details on how the bridge automatically loads the subsystem identification and other register defaults from the serial-bus EEPROM.

Figure 3-9 illustrates a single byte write. The bridge issues a start condition and sends the 7-bit slave device address and the R/W command bit is equal to 0b. A 0b in the R/W command bit indicates that the data transfer is a write. The slave device acknowledges if it recognizes the slave address. If no acknowledgment is received by the bridge, then bit 1 (SB_ERR) is set in the serial-bus control and status register (PCI offset B3h, see Section 4.59). Next, the EEPROM word address is sent by the bridge, and another slave acknowledgment is expected. Then the bridge delivers the data byte MSB first and expects a final acknowledgment before issuing the stop condition.

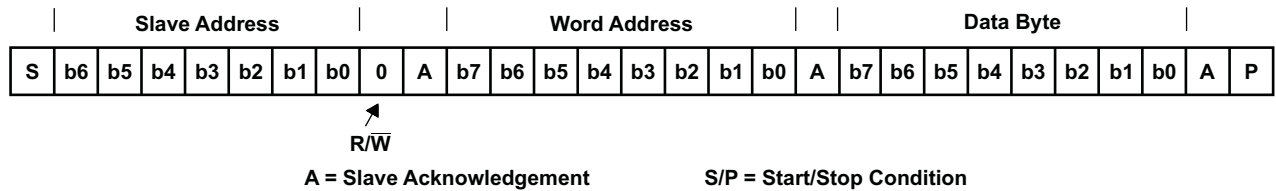

Figure 3-9. Serial-Bus Protocol – Byte Write

Figure 3-10 illustrates a single byte read. The bridge issues a start condition and sends the 7-bit slave device address and the R/W command bit is equal to 0b (write). The slave device acknowledges if it recognizes the slave address. Next, the EEPROM word address is sent by the bridge, and another slave acknowledgment is expected. Then, the bridge issues a restart condition followed by the 7-bit slave address and the R/W command bit is equal to 1b (read). Once again, the slave device responds with an acknowledge. Next, the slave device sends the 8-bit data byte, MSB first. Since this is a 1-byte read, the bridge responds with no acknowledge (logic high) indicating the last data byte. Finally, the bridge issues a stop condition.

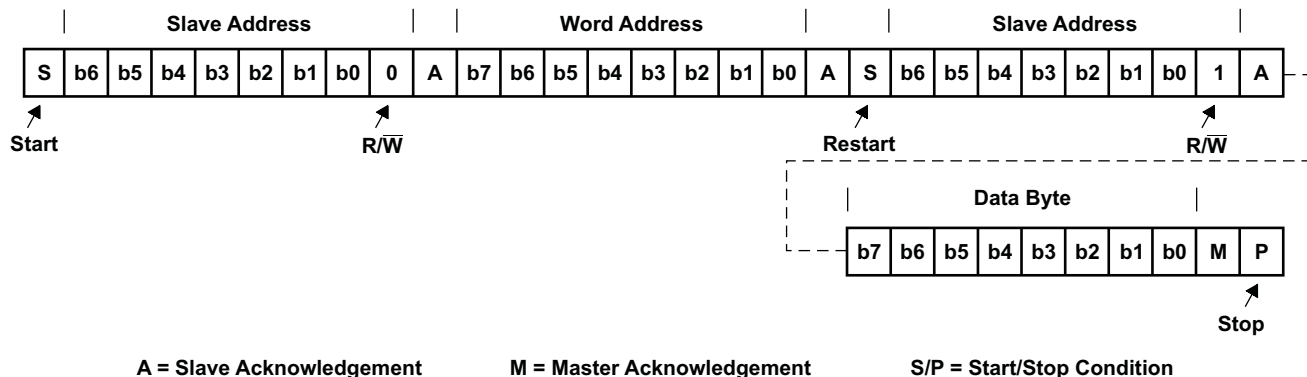

Figure 3-10. Serial-Bus Protocol – Byte Read

Figure 3-11 illustrates the serial interface protocol during a multi-byte serial EEPROM download. The serial-bus protocol starts exactly the same as a 1-byte read. The only difference is that multiple data bytes are transferred. The number of transferred data bytes is controlled by the bridge master. After each data byte, the bridge master issues acknowledge (logic low) if more data bytes are requested. The transfer ends after a bridge master no acknowledge (logic high) followed by a stop condition.

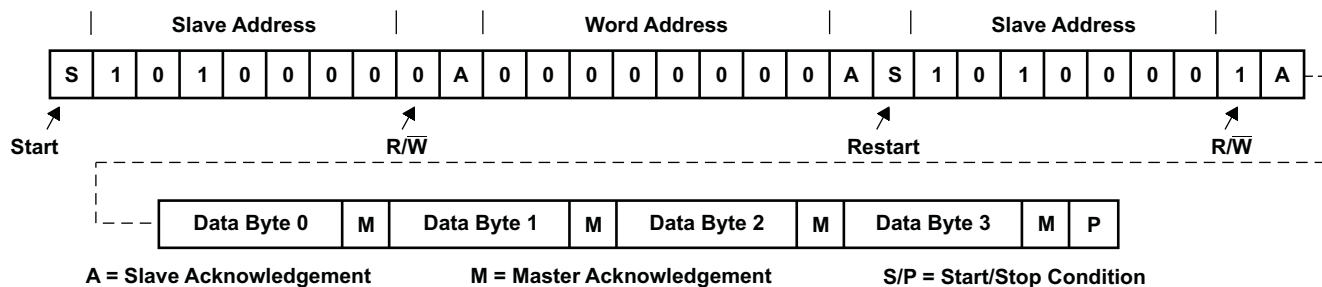

Figure 3-11. Serial-Bus Protocol – Multibyte Read

Bit 7 (PROT_SEL) in the serial-bus control and status register changes the serial-bus protocol. Each of the three previous serial-bus protocol figures illustrates the PROT_SEL bit default (logic low). When this control bit is asserted, the word address and corresponding acknowledge are removed from the serial-bus protocol. This feature allows the system designer a second serial-bus protocol option when selecting external EEPROM devices.

3.5.3 Serial-Bus EEPROM Application

The registers and corresponding bits that are loaded through the EEPROM are provided in Table 3-4.

Table 3-4. EEPROM Register Loading Map

| SERIAL EEPROM WORD ADDRESS | BYTE DESCRIPTION |
|----------------------------|--|
| 00h | PCI-Express to PCI bridge function indicator (00h) |
| 01h | Number of bytes to download (1Eh)s |
| 02h | PCI 84h, subsystem vendor ID, byte 0 |
| 03h | PCI 85h, subsystem vendor ID, byte 1 |
| 04h | PCI 86h, subsystem ID, byte 0s |
| 05h | PCI 87h, subsystem ID, byte 1s |
| 06h | PCI D4h, general control, byte 0 |
| 07h | PCI D5h, general control, byte 1 |
| 08h | PCI D6h, general control, byte 2 |

Table 3-4. EEPROM Register Loading Map (continued)

| SERIAL EEPROM WORD ADDRESS | BYTE DESCRIPTION | | | | | |
|----------------------------|--|---|---------------|----------------------------------|-------------------------------|-------------|
| 09h | PCI D7h, general control, byte 3 | | | | | |
| 0Ah | TI Proprietary register load 00h (PCI D8h) | | | | | |
| 0Bh | TI Proprietary register load 00h (PCI D9h) | | | | | |
| 0Ch | Reserved—no bits loaded 00h (PCI DAh) | | | | | |
| 0Dh | PCI DCh, arbiter control | | | | | |
| 0Eh | PCI DDh, arbiter request mask | | | | | |
| 0Fh | PCI C0h, TL control and diagnostic register, byte 0 | | | | | |
| 10h | PCI C0h, TL control and diagnostic register, byte 1 | | | | | |
| 11h | PCI C0h, TL control and diagnostic register, byte 2 | | | | | |
| 12h | PCI C0h, TL control and diagnostic register, byte 3 | | | | | |
| 13h | PCI C4h, DLL control and diagnostic register, byte 0 | | | | | |
| 14h | PCI C5h, DLL control and diagnostic register, byte 1 | | | | | |
| 15h | PCI C6h, DLL control and diagnostic register, byte 2 | | | | | |
| 16h | PCI C7h, DLL control and diagnostic register, byte 3 | | | | | |
| 17h | PCI C8h, PHY control and diagnostic register, byte 0 | | | | | |
| 18h | PCI C9h, PHY control and diagnostic register, byte 1 | | | | | |
| 19h | PCI CAh, PHY control and diagnostic register, byte 2 | | | | | |
| 1Ah | PCI CBh, PHY control and diagnostic register, byte 3 | | | | | |
| 1Bh | Reserved—no bits loaded 00h (PCI CEh) | | | | | |
| 1Ch | Reserved—no bits loaded 00h (PCI CFh) | | | | | |
| 1Dh | TI Proprietary register load 00h (PCI E0h) | | | | | |
| 1Eh | TI Proprietary register load 00h (PCI E2h) | | | | | |
| 1Fh | TI Proprietary register load 00h (PCI E3h) | | | | | |
| 20h | 1394 OHCI function indicator (01h) | | | | | |
| 21h | Number of bytes (18h) | | | | | |
| 22h | PCI 3Fh, maximum latency, bits 7-4 | | | PCI 3Eh, minimum grant, bits 3-0 | | |
| 23h | PCI 2Ch, subsystem vendor ID, byte 0 | | | | | |
| 24h | PCI 2Dh, subsystem vendor ID, byte 1 | | | | | |
| 25h | PCI 2Eh, subsystem ID, byte 0 | | | | | |
| 26h | PCI 2Fh, subsystem ID, byte 1 | | | | | |
| 27h | [7] Link_Enh enab_unfair | [6] HC Control Program Phy Enable | [5:3] RSVD | [2] Link_Enh bit 2 | [1] Link_Enh enab_accel | [0] RSVD |
| 28h | Mini-ROM Address, this byte indicates the MINI ROM offset into the EEPROM 00h = No MINI ROM 01h to FFh = MINI ROM offset | | | | | |
| 29h | OHCI 24h, GUIDHi, byte 0 | | | | | |
| 2Ah | OHCI 25h, GUIDHi, byte 1 | | | | | |
| 2Bh | OHCI 26h, GUIDHi, byte 2 | | | | | |
| 2Ch | OHCI 27h, GUIDHi, byte 3 | | | | | |
| 2Dh | OHCI 28h, GUIDLo, byte 0 | | | | | |
| 2Eh | OHCI 29h, GUIDLo, byte 1 | | | | | |
| 2Fh | OHCI 2Ah, GUIDLo, byte 2 | | | | | |
| 30h | OHCI 2Bh, GUIDLo, byte 3 | | | | | |
| 31h | Reserved – No bits loaded | | | | | |
| 32h | PCI F5h, Link_Enh, byte 1, bits 7, 6, 5, 4 | | | | | |
| 33h | PCI F0h, PCI miscellaneous, byte 0, bits 7, 4, 2, 1, 0 | | | | | |
| 34h | PCI F1h, PCI miscellaneous, byte 1, bits 1, 0 | | | | | |

Table 3-4. EEPROM Register Loading Map (continued)

| SERIAL EEPROM WORD ADDRESS | BYTE DESCRIPTION |
|----------------------------|--|
| 35h | Reserved – No bits loaded |
| 36h | Reserved – No bits loaded |
| 37h | Reserved – No bits loaded |
| 38h | Reserved – No bits loaded |
| 39h | Reserved – Multifunton Select Register |
| 3Ah | End-of-list indicator (80h) |

This format must be explicitly followed for the bridge to correctly load initialization values from a serial EEPROM. All byte locations must be considered when programming the EEPROM.

The serial EEPROM is addressed by the bridge at slave address 1010 000b. This slave address is internally hardwired and cannot be changed by the system designer. Therefore, all three hardware address bits for the EEPROM are tied to VSS to achieve this address. The serial EEPROM in the sample application circuit ([Figure 3-6](#)) assumes the 1010b high-address nibble. The lower three address bits are terminal inputs to the chip, and the sample application shows these terminal inputs tied to V_{SS}.

During an EEPROM download operation, bit 4 (ROMBUSY) in the serial-bus control and status register is asserted. After the download is finished, bit 0 (ROM_ERR) in the serial-bus control and status register may be monitored to verify a successful download.

3.5.4 Accessing Serial-Bus Devices Through Software

The bridge provides a programming mechanism to control serial-bus devices through system software. The programming is accomplished through a doubleword of PCI configuration space at offset B0h. [Table 3-5](#) lists the registers that program a serial-bus device through software.

Table 3-5. Registers Used To Program Serial-Bus Devices

| PCI OFFSET | REGISTER NAME | DESCRIPTION |
|------------|---|--|
| B0h | Serial-bus data (see Section 4.56) | Contains the data byte to send on write commands or the received data byte on read commands. |
| B1h | Serial-bus word address (see Section 4.57) | The content of this register is sent as the word address on byte writes or reads. This register is not used in the quick command protocol. Bit 7 (PROT_SEL) in the serial-bus control and status register (offset B3h, see Section 4.59) is set to 1b to enable the slave address to be sent. |
| B2h | Serial-bus slave address (see Section 4.58) | Write transactions to this register initiate a serial-bus transaction. The slave device address and the R/W command selector are programmed through this register. |
| B3h | Serial-bus control and status (see Section 4.59) | Serial interface enable, busy, and error status are communicated through this register. In addition, the protocol-select bit (PROT_SEL) and serial-bus test bit (SBTEST) are programmed through this register. |

To access the serial EEPROM through the software interface, the following steps are performed:

1. The control and status byte is read to verify the EEPROM interface is enabled (SBDETECT asserted) and not busy (REQBUSY and ROMBUSY deasserted).
2. The serial-bus word address is loaded. If the access is a write, then the data byte is also loaded.
3. The serial-bus slave address and R/W command selector byte is written.
4. REQBUSY is monitored until this bit is deasserted.
5. SB_ERR is checked to verify that the serial-bus operation completed without error. If the operation is a read, then the serial-bus data byte is now valid.

3.6 Advanced Error Reporting Registers

In the extended PCI Express configuration space, the bridge supports the advanced error reporting capabilities structure. For the PCI Express interface, both correctable and uncorrectable error statuses are provided. For the PCI bus interface, secondary uncorrectable error status is provided. All uncorrectable status bits have corresponding mask and severity control bits. For correctable status bits, only mask bits are provided.

Both the primary and secondary interfaces include first error pointer and header log registers. When the first error is detected, the corresponding bit position within the uncorrectable status register is loaded into the first error pointer register. Likewise, the header information associated with the first failing transaction is loaded into the header log. To reset this first error control logic, the corresponding status bit in the uncorrectable status register is cleared by a writeback of 1b.

For systems that require high data reliability, ECRC is fully supported on the PCI Express interface. The primary side advanced error capabilities and control register has both ECRC generation and checking enable control bits. When the checking bit is asserted, all received TLPs are checked for a valid ECRC field. If the generation bit is asserted, then all transmitted TLPs contain a valid ECRC field.

3.7 Data Error Forwarding Capability

The bridge supports the transfer of data errors in both directions.

If a downstream PCI Express transaction with a data payload is received that targets the internal PCI bus and the EP bit is set indicating poisoned data, then the bridge must ensure that this information is transferred to the PCI bus. To do this, the bridge forces a parity error on each PCI bus data phase by inverting the parity bit calculated for each double-word of data.

If the bridge is the target of a PCI transaction that is forwarded to the PCI Express interface and a data parity error is detected, then this information is passed to the PCI Express interface. To do this, the bridge sets the EP bit in the upstream PCI Express header.

3.8 General-Purpose I/O Interface

Up to eight general-purpose input/output (GPIO) terminals are provided for system customization. These GPIO terminals are 3.3-V tolerant.

The exact number of GPIO terminals varies based on implementing the clock run, power override, and serial EEPROM interface features. These features share four of the eight GPIO terminals. When any of the three shared functions are enabled, the associated GPIO terminal is disabled.

All eight GPIO terminals are individually configurable as either inputs or outputs by writing the corresponding bit in the GPIO control register at offset B4h. A GPIO data register at offset B6h exists to either read the logic state of each GPIO input or to set the logic state of each GPIO output. The power-up default state for the GPIO control register is input mode.

3.9 Set Slot Power Limit Functionality

The *PCI Express Specification* provides a method for devices to limit internal functionality and save power based on the value programmed into the captured slot power limit scale (CSPLS) and capture slot power limit value (CSPLV) fields of the PCI Express device capabilities register at offset 94h. See [Section 4.50, Device Capabilities Register](#), for details. The bridge writes these fields when a set slot power limit message is received on the PCI Express interface.

After the deassertion of $\overline{\text{PERST}}$, the XIO2213A compares the information within the CSPLS and CSPLV fields of the device capabilities register to the minimum power scale (MIN_POWER_SCALE) and minimum power value (MIN_POWER_VALUE) fields in the general control register at offset D4h. See [Section 4.66, General Control Register](#), for details. If the CSPLS and CSPLV fields are less than the MIN_POWER_SCALE and MIN_POWER_VALUE fields, respectively, then the bridge takes the appropriate action that is defined below.

The power usage action is programmable within the bridge. The general control register includes a 3-bit POWER_OVRD field. This field is programmable to the following two options:

1. Ignore slot power limit fields
2. Respond with unsupported request to all transactions except type 0/1 configuration transactions and set slot power limit messages

3.10 PCI Express and PCI Bus Power Management

The bridge supports both software-directed power management and active state power management through standard PCI configuration space. Software-directed registers are located in the power management capabilities structure located at offset 50h. Active state power management control registers are located in the PCI Express capabilities structure located at offset 90h.

During software-directed power management state changes, the bridge initiates link state transitions to L1 or L2/L3 after a configuration write transaction places the device in a low power state. The power management state machine is also responsible for gating internal clocks based on the power state. [Table 3-6](#) identifies the relationship between the D-states and bridge clock operation.

Table 3-6. Clocking In Low Power States

| CLOCK SOURCE | D0/L0 | D1/L1 | D2/L1 | D3/L2/L3 |
|---|-------|-------|-------|----------|
| PCI express reference clock input (REFCLK) | On | On | On | On/Off |
| Internal PCI bus clock to bridge function | On | Off | Off | Off |
| Internal PCI bus clock to 1394b OHCI function | On | On | On | On/Off |

The link power management (LPM) state machine manages active state power by monitoring the PCI Express transaction activity. If no transactions are pending and the transmitter has been idle for at least the minimum time required by the *PCI Express Specification*, then the LPM state machine transitions the link to either the L0s or L1 state. By reading the bridge's L0s and L1 exit latency in the link capabilities register, the system software may make an informed decision relating to system performance versus power savings. The ASLPMC field in the link control register provides an L0s only option, L1 only option, or both L0s and L1 option.

Finally, the bridge generates the PM_Active_State_Nak Message if a PM_Active_State_Request_L1 DLLP is received on the PCI Express interface and the link cannot be transitioned to L1.

3.11 1394b OHCI Controller Functionality

3.11.1 1394b OHCI Power Management

The 1394b OHCI controller complies with the *PCI Bus Power Management Interface Specification*. The controller supports the D0 (uninitialized), D0 (active), D1, D2, and D3 power states as defined by the power management definition in the *1394 Open Host Controller Interface Specification*, Appendix A4.

[Table 3-7](#) identifies the supported power management registers within the 1394 OHCI configuration register map.

Table 3-7. 1394b OHCI Configuration Register Map

| REGISTER NAME | | | OFFSET |
|---------------|--|---------------------------------------|--------|
| | Power management capabilities | Next item pointer | 44h |
| PM data | Power management control/status register bridge support extensions | Power management control/status (CSR) | 48h |

3.11.2 1394b OHCI and V_{AUX}

The 1394b OHCI function within the XIO2213A is powered by V_{DD_MAIN} only. Therefore, during the D3_{cold} power management state, V_{AUX} is not supplied to the 1394b OHCI function.

This implies that the 1394b OHCI function does not implement sticky bits and needs to be initialized after a D3_{cold} power management state. An external serial EEPROM interface is available to initialize critical configuration register bits. The EEPROM download is triggered by the deassertion of the \overline{PERST} input. Otherwise, the BIOS will need to initialize the 1394b OHCI function.

3.11.3 1394b OHCI and Reset Options

The 1394b OHCI function is completely reset by the internal power-on reset feature, by the GRST input, or by the PCI Express reset (\overline{PERST}) input. This includes all EEPROM loadable bits, power management functions, and all remaining configuration register bits and logic.

A PCI Express training control hot reset or the PCI bus configuration register reset bit (SRST) excludes the EEPROM loadable bits, power management functions, and 1394 PHY. All remaining configuration registers and logic are reset.

If the OHCI controller is in the power management D2 or D3 state or if the OHCI configuration register reset bit (SoftReset) is set, the OHCI controller DMA logic and link logic is reset.

Finally, if the OHCI configuration register PHY reset bit (ISBR) is set, the 1394 PHY logic is reset.

3.11.4 1394b OHCI PCI Bus Master

As a bus master, the 1394 OHCI function supports the memory commands specified in [Table 3-8](#). The commands include memory read, memory read line, memory read multiple, memory write, and memory write and invalidate.

The read command usage for read transactions of greater than two data phases are determined by the selection in bits 9:8 (MR_ENHANCE field) of the PCI miscellaneous configuration register at offset F0h (see [Section 7.21](#)). For read transactions of one or two data phases, a memory read command is used.

The write command usage is determined by the MWI_ENB bit 4 of the command configuration register at offset 04h (see [Section 4.3](#)). If bit 4 is asserted and a memory write starts on a cache boundary with a length greater than one cache line, then memory write and invalidate commands are used. Otherwise, memory write commands are used.

Table 3-8. 1394 OHCI Memory Command Options

| PCI | COMMAND C/BE3–C/BE0 | OHCI MASTER FUNCTION |
|-----------------------------|------------------------|----------------------|
| Memory read | 0110 | DMA read from memory |
| Memory write | 0111 | DMA write to memory |
| Memory read multiple | 1100 | DMA read from memory |
| Memory read line | 1110 | DMA read from memory |
| Memory write and invalidate | 1111 | DMA write to memory |

3.11.5 1394b OHCI Subsystem Identification

The subsystem identification register at offset 2Ch is used for system and option card identification purposes. This register can be initialized from the serial EEPROM or programmed via the subsystem access register at offset F8h in the 1394a OHCI PCI configuration space (see [Section 7.23](#)).

Write access to the subsystem access register updates the subsystem identification registers identically to OHCI-Lynx™. The contents of the subsystem access register are aliased to the subsystem vendor ID and subsystem ID registers at PCI offsets 2Ch and 2Eh, respectively. The subsystem ID value written to this register may also be read back from this register.

3.11.6 1394b OHCI PME Support

Since the 1394b OHCI controller is not connected to VAUX, PME generation is disabled for D3cold power management states.

4 Classic PCI Configuration Space

The programming model of the XIO2213A PCI-Express to PCI bridge is compliant to the classic PCI-to-PCI bridge programming model. The PCI configuration map uses the type 1 PCI bridge header.

All bits marked with a **a** are sticky bits and are reset by a global reset ($\overline{\text{GRST}}$) or the internally-generated power-on reset. All bits marked with a **l** are reset by a PCI Express reset ($\overline{\text{PERST}}$), a $\overline{\text{GRST}}$, or the internally-generated power-on reset. The remaining register bits are reset by a PCI Express hot reset, $\overline{\text{PERST}}$, $\overline{\text{GRST}}$, or the internally-generated power-on reset.

Table 4-1. Classic PCI Configuration Register Map

| REGISTER NAME | | | | OFFSET |
|--|---|--|--------------------------------|-----------|
| Device ID | | Vendor ID | | 000h |
| Status | | Command | | 004h |
| Class code | | | Revision ID | 008h |
| BIST | Header type | Latency timer | Cache line size | 00Ch |
| Device control base address | | | | 010h |
| Scratchpad RAM base address | | | | 014h |
| Secondary latency timer | Subordinate bus number | Secondary bus number | Primary bus number | 018h |
| Secondary status | | I/O limit | I/O base | 01Ch |
| Memory limit | | Memory base | | 020h |
| Prefetchable memory limit | | Prefetchable memory base | | 024h |
| Prefetchable base upper 32 bits | | | | 028h |
| Prefetchable limit upper 32 bits | | | | 02Ch |
| I/O limit upper 16 bits | | I/O base upper 16 bits | | 030h |
| Reserved | | | Capabilities pointer | 034h |
| Reserved | | | | 038h |
| Bridge control | | Interrupt pin | Interrupt line | 03Ch |
| Reserved | | | | 040h-04Ch |
| Power management capabilities | | Next item pointer | PM capability ID | 050h |
| PM data | PMCSR_BSE | Power management CSR | | 054h |
| Reserved | | | | 058h-05Ch |
| MSI message control | | Next item pointer | MSI CAP ID | 060h |
| MSI message address | | | | 064h |
| MSI upper message address | | | | 068h |
| Reserved | | MSI message data | | 06Ch |
| Reserved | | | | 070h-07Ch |
| Reserved | | Next item pointer | SSID/SSVID capability ID | 080h |
| Subsystem ID ⁽¹⁾ | | Subsystem vendor ID ⁽¹⁾ | | 084h |
| Reserved | | | | 088h-08Ch |
| PCI Express capabilities register | | Next item pointer | PCI Express capability ID | 090h |
| Device capabilities | | | | 094h |
| Device status | | Device control | | 098h |
| Link capabilities | | | | 09Ch |
| Link status | | Link control | | 0A0h |
| Reserved | | | | 0A4h-0ACh |
| Serial-bus control and status ⁽¹⁾ | Serial-bus slave address ⁽¹⁾ | Serial-bus word address ⁽¹⁾ | Serial-bus data ⁽¹⁾ | 0B0h |
| GPIO data ⁽¹⁾ | | GPIO control ⁽¹⁾ | | 0B4h |
| Reserved | | | | 0B8h-0BCh |

(1) One or more bits in this register are reset by a PCI Express reset ($\overline{\text{PERST}}$), a $\overline{\text{GRST}}$, or the internally-generated power-on reset.

Table 4-1. Classic PCI Configuration Register Map (continued)

| REGISTER NAME | | | | OFFSET |
|--|-------------------------------|-------------------------------------|--------------------------------|-----------|
| Control and diagnostic register 0 ⁽¹⁾ | | | | 0C0h |
| Control and diagnostic register 1 ⁽¹⁾ | | | | 0C4h |
| Control and diagnostic register 2 ⁽¹⁾ | | | | 0C8h |
| Reserved | | | | 0CCh |
| Subsystem access ⁽¹⁾ | | | | 0D0h |
| General control ⁽¹⁾ | | | | 0D4h |
| Reserved | TI proprietary ⁽¹⁾ | TI proprietary ⁽¹⁾ | TI proprietary ⁽¹⁾ | 0D8h |
| Reserved | Arbiter time-out status | Arbiter request mask ⁽¹⁾ | Arbiter control ⁽¹⁾ | 0DCh |
| TI proprietary ⁽¹⁾ | | Reserved | TI proprietary ⁽¹⁾ | 0E0h |
| Reserved | | TI proprietary | | 0E4h |
| Reserved | | | | 0E8h-0FCh |

4.1 Vendor ID Register

This 16-bit read-only register contains the value 104Ch, which is the vendor ID assigned to Texas Instruments.,

PCI register offset: 00h

Register type: Read-only

Default value: 104Ch

| BIT NUMBER | 15 | 14 | 13 | 12 | 11 | 10 | 9 | 8 | 7 | 6 | 5 | 4 | 3 | 2 | 1 | 0 |
|-------------|----|----|----|----|----|----|---|---|---|---|---|---|---|---|---|---|
| RESET STATE | 0 | 0 | 0 | 1 | 0 | 0 | 0 | 0 | 0 | 1 | 0 | 0 | 1 | 1 | 0 | 0 |

4.2 Device ID Register

This 16-bit read-only register contains the value 823Eh, which is the device ID assigned by TI for the bridge.,

PCI register offset: 02h

Register type: Read-only

Default value: 823Eh

| BIT NUMBER | 15 | 14 | 13 | 12 | 11 | 10 | 9 | 8 | 7 | 6 | 5 | 4 | 3 | 2 | 1 | 0 |
|-------------|----|----|----|----|----|----|---|---|---|---|---|---|---|---|---|---|
| RESET STATE | 1 | 0 | 0 | 0 | 0 | 0 | 1 | 0 | 0 | 0 | 1 | 1 | 0 | 0 | 0 | 1 |

4.3 Command Register

The command register controls how the bridge behaves on the PCI Express interface. See [Table 4-2](#) for a complete description of the register contents.

PCI register offset: 04h

Register type: Read-only, Read/Write

Default value: 0000h

| BIT NUMBER | 15 | 14 | 13 | 12 | 11 | 10 | 9 | 8 | 7 | 6 | 5 | 4 | 3 | 2 | 1 | 0 |
|-------------|----|----|----|----|----|----|---|---|---|---|---|---|---|---|---|---|
| RESET STATE | 0 | 0 | 0 | 0 | 0 | 0 | 0 | 0 | 0 | 0 | 0 | 0 | 0 | 0 | 0 | 0 |

Table 4-2. Command Register Description

| BIT | FIELD NAME | ACCESS | DESCRIPTION |
|-------|-------------|--------|--|
| 15:11 | RSVD | R | Reserved. Returns 00000b when read. |
| 10 | INT_DISABLE | R | $\overline{\text{INTx}}$ disable. This bit enables device specific interrupts. Since the bridge does not generate any internal interrupts, this bit is read-only 0b. |
| 9 | FBB_ENB | R | Fast back-to-back enable. The bridge does not generate fast back-to-back transactions; therefore, this bit returns 0b when read. |
| 8 | SERR_ENB | RW | $\overline{\text{SERR}}$ enable bit. When this bit is set, the bridge can signal fatal and nonfatal errors on the PCI Express interface on behalf of SERR assertions detected on the PCI bus. 0 = Disable the reporting of nonfatal errors and fatal errors (default) 1 = Enable the reporting of nonfatal errors and fatal errors |
| 7 | STEP_ENB | R | Address/data stepping control. The bridge does not support address/data stepping, and this bit is hardwired to 0b. |
| 6 | PERR_ENB | RW | Controls the setting of bit 8 (DATAPAR) in the status register (offset 06h, see Section 4.4) in response to a received poisoned TLP from PCI Express. A received poisoned TLP is forwarded with bad parity to conventional PCI regardless of the setting of this bit. 0 = Disables the setting of the master data parity error bit (default) 1 = Enables the setting of the master data parity error bit |
| 5 | VGA_ENB | R | VGA palette snoop enable. The bridge does not support VGA palette snooping; therefore, this bit returns 0b when read. |
| 4 | MWI_ENB | RW | Memory write and invalidate enable. When this bit is set, the bridge translates PCI Express memory write requests into memory write and invalidate transactions on the PCI interface. 0 = Disable the promotion to memory write and invalidate (default) 1 = Enable the promotion to memory write and invalidate |
| 3 | SPECIAL | R | Special cycle enable. The bridge does not respond to special cycle transactions; therefore, this bit returns 0b when read. |
| 2 | MASTER_ENB | RW | Bus master enable. When this bit is set, the bridge is enabled to initiate transactions on the PCI Express interface. 0 = PCI Express interface cannot initiate transactions. The bridge must disable the response to memory and I/O transactions on the PCI interface (default). 1 = PCI Express interface can initiate transactions. The bridge can forward memory and I/O transactions from PCI secondary interface to the PCI Express interface. |
| 1 | MEMORY_ENB | RW | Memory space enable. Setting this bit enables the bridge to respond to memory transactions on the PCI Express interface. 0 = PCI Express receiver cannot process downstream memory transactions and must respond with an unsupported request (default) 1 = PCI Express receiver can process downstream memory transactions. The bridge can forward memory transactions to the PCI interface. |
| 0 | IO_ENB | RW | I/O space enable. Setting this bit enables the bridge to respond to I/O transactions on the PCI Express interface. 0 = PCI Express receiver cannot process downstream I/O transactions and must respond with an unsupported request (default) 1 = PCI Express receiver can process downstream I/O transactions. The bridge can forward I/O transactions to the PCI interface. |

4.4 Status Register

The status register provides information about the PCI Express interface to the system. See [Table 4-3](#) for a complete description of the register contents.

PCI register offset: 06h
Register type: Read-only, Read/Clear
Default value: 0010h

| BIT NUMBER | 15 | 14 | 13 | 12 | 11 | 10 | 9 | 8 | 7 | 6 | 5 | 4 | 3 | 2 | 1 | 0 |
|-------------|----|----|----|----|----|----|---|---|---|---|---|---|---|---|---|---|
| RESET STATE | 0 | 0 | 0 | 0 | 0 | 0 | 0 | 0 | 0 | 0 | 0 | 1 | 0 | 0 | 0 | 0 |

Table 4-3. Status Register Description

| BIT | FIELD NAME | ACCESS | DESCRIPTION |
|------|------------|--------|---|
| 15 | PAR_ERR | RCU | Detected parity error. This bit is set when the PCI Express interface receives a poisoned TLP. This bit is set regardless of the state of bit 6 (PERR_ENB) in the command register (offset 04h, see Section 4.3). 0 = No parity error detected 1 = Parity error detected |
| 14 | SYS_ERR | RCU | Signaled system error. This bit is set when the bridge sends an ERR_FATAL or ERR_NONFATAL message and bit 8 (SERR_ENB) in the command register (offset 04h, see Section 4.3) is set. 0 = No error signaled 1 = ERR_FATAL or ERR_NONFATAL signaled |
| 13 | MABORT | RCU | Received master abort. This bit is set when the PCI Express interface of the bridge receives a completion-with-unsupported-request status. 0 = Unsupported request not received on the PCI Express interface 1 = Unsupported request received on the PCI Express interface |
| 12 | TABORT_REC | RCUT | Received target abort. This bit is set when the PCI Express interface of the bridge receives a completion-with-completer-abort status. 0 = Completer abort not received on the PCI Express interface 1 = Completer abort received on the PCI Express interface |
| 11 | TABORT_SIG | RCUT | Signaled target abort. This bit is set when the PCI Express interface completes a request with completer abort status. 0 = Completer abort not signaled on the PCI Express interface 1 = Completer abort signaled on the PCI Express interface |
| 10:9 | PCI_SPEED | R | DEVSEL timing. These bits are read-only 00b, because they do not apply to PCI Express. |
| 8 | DATAPAR | RCU | Master data parity error. This bit is set if bit 6 (PERR_ENB) in the command register (offset 04h, see Section 4.3) is set and the bridge receives a completion with data marked as poisoned on the PCI Express interface or poisons a write request received on the PCI Express interface. 0 = No uncorrectable data error detected on the primary interface 1 = Uncorrectable data error detected on the primary interface |
| 7 | FBB_CAP | R | Fast back-to-back capable. This bit does not have a meaningful context for a PCI Express device and is hardwired to 0b. |
| 6 | RSVD | R | Reserved. Returns 0b when read. |
| 5 | 66MHZ | R | 66-MHz capable. This bit does not have a meaningful context for a PCI Express device and is hardwired to 0b. |
| 4 | CAPLIST | R | Capabilities list. This bit returns 1b when read, indicating that the bridge supports additional PCI capabilities. |
| 3 | INT_STATUS | R | Interrupt status. This bit reflects the interrupt status of the function. This bit is read-only 0b since the bridge does not generate any interrupts internally. |
| 2:0 | RSVD | R | Reserved. Returns 000b when read. |

4.5 Class Code and Revision ID Register

This read-only register categorizes the base class, subclass, and programming interface of the bridge. The base class is 06h, identifying the device as a bridge. The subclass is 04h, identifying the function as a PCI-to-PCI bridge, and the programming interface is 00h. Furthermore, the TI device revision is indicated in the lower byte (00h). See [Table 4-4](#) for a complete description of the register contents.

PCI register offset: 08h
 Register type: Read-only
 Default value: 0604 0001h

| | | | | | | | | | | | | | | | | |
|--------------------|-----------|-----------|-----------|-----------|-----------|-----------|-----------|-----------|-----------|-----------|-----------|-----------|-----------|-----------|-----------|-----------|
| BIT NUMBER | 31 | 30 | 29 | 28 | 27 | 26 | 25 | 24 | 23 | 22 | 21 | 20 | 19 | 18 | 17 | 16 |
| RESET STATE | 0 | 0 | 0 | 0 | 0 | 1 | 1 | 0 | 0 | 0 | 0 | 0 | 0 | 1 | 0 | 0 |

| | | | | | | | | | | | | | | | | |
|--------------------|-----------|-----------|-----------|-----------|-----------|-----------|----------|----------|----------|----------|----------|----------|----------|----------|----------|----------|
| BIT NUMBER | 15 | 14 | 13 | 12 | 11 | 10 | 9 | 8 | 7 | 6 | 5 | 4 | 3 | 2 | 1 | 0 |
| RESET STATE | 0 | 0 | 0 | 0 | 0 | 0 | 0 | 0 | 0 | 0 | 0 | 0 | 0 | 0 | 0 | 1 |

Table 4-4. Class Code and Revision ID Register Description

| BIT | FIELD NAME | ACCESS | DESCRIPTION |
|-------|------------|--------|---|
| 31:24 | BASECLASS | R | Base class. This field returns 06h when read, which classifies the function as a bridge device. |
| 23:16 | SUBCLASS | R | Subclass. This field returns 04h when read, which classifies the function as a PCI-to-PCI bridge. |
| 15:8 | PGMIF | R | Programming interface. This field returns 00h when read. |
| 7:0 | CHIPREV | R | Silicon revision. This field returns the silicon revision of the function. |

4.6 Cache Line Size Register

If the EN_CACHE_LINE_CHECK bit in the TL Control and Diagnostic Register is '0', then Cheetah-Express shall use side-band signals from the 1394b OHCI core to determine how much data to fetch when handling delayed read transactions. In this case, the Cache Line Size Register shall have no effect on the design and shall essentially be a read/write scratch pad register. If the EN_CACHE_LINE_CHECK bit is '1', then the Cache Line Size Register is used by the bridge to determine how much data to pre-fetch when handling delayed read transactions. In this case, the value in this register must be programmed to a power of 2, and any value greater than 32 DWORDs will be treated as 32 DWORDs.

PCI register offset: 0Ch
 Register type: Read/Write
 Default value: 00h

| | | | | | | | | |
|--------------------|----------|----------|----------|----------|----------|----------|----------|----------|
| BIT NUMBER | 7 | 6 | 5 | 4 | 3 | 2 | 1 | 0 |
| RESET STATE | 0 | 0 | 0 | 0 | 0 | 0 | 0 | 0 |

4.7 Primary Latency Timer Register

This read-only register has no meaningful context for a PCI Express device and returns 00h when read.

PCI register offset: 0Dh
 Register type: Read only
 Default value: 00h

| | | | | | | | | |
|--------------------|----------|----------|----------|----------|----------|----------|----------|----------|
| BIT NUMBER | 7 | 6 | 5 | 4 | 3 | 2 | 1 | 0 |
| RESET STATE | 0 | 0 | 0 | 0 | 0 | 0 | 0 | 0 |

4.8 Header Type Register

This read-only register indicates that this function has a type one PCI header. Bit 7 of this register is 0b indicating that the bridge is a single-function device.

PCI register offset: 0Eh
 Register type: Read only
 Default value: 01h

| BIT NUMBER | 7 | 6 | 5 | 4 | 3 | 2 | 1 | 0 |
|-------------|---|---|---|---|---|---|---|---|
| RESET STATE | 0 | 0 | 0 | 0 | 0 | 0 | 0 | 1 |

4.9 BIST Register

Since the bridge does not support a built-in self test (BIST), this read-only register returns the value of 00h when read.

PCI register offset: 0Fh
 Register type: Read only
 Default value: 00h

| BIT NUMBER | 7 | 6 | 5 | 4 | 3 | 2 | 1 | 0 |
|-------------|---|---|---|---|---|---|---|---|
| RESET STATE | 0 | 0 | 0 | 0 | 0 | 0 | 0 | 0 |

4.10 Device Control Base Address Register

This read/write register programs the memory base address that accesses the device control registers. See [Table 4-5](#) for a complete description of the register contents.

PCI register offset: 10h
 Register type: Read-only, Read/Write
 Default value: 0000 0000h

| BIT NUMBER | 31 | 30 | 29 | 28 | 27 | 26 | 25 | 24 | 23 | 22 | 21 | 20 | 19 | 18 | 17 | 16 |
|-------------|----|----|----|----|----|----|----|----|----|----|----|----|----|----|----|----|
| RESET STATE | 0 | 0 | 0 | 0 | 0 | 0 | 0 | 0 | 0 | 0 | 0 | 0 | 0 | 0 | 0 | 0 |

| BIT NUMBER | 15 | 14 | 13 | 12 | 11 | 10 | 9 | 8 | 7 | 6 | 5 | 4 | 3 | 2 | 1 | 0 |
|-------------|----|----|----|----|----|----|---|---|---|---|---|---|---|---|---|---|
| RESET STATE | 0 | 0 | 0 | 0 | 0 | 0 | 0 | 0 | 0 | 0 | 0 | 0 | 0 | 0 | 0 | 0 |

Table 4-5. Device Control Base Address Register Description

| BIT | FIELD NAME | ACCESS | DESCRIPTION |
|-------|------------|---------|---|
| 31:12 | ADDRESS | R or RW | Memory Address. The memory address field for XIO2213A uses 20 read/write bits indicating that 4096 bytes of memory space are required. While less than this is actually used, typical systems will allocate this space on a 4K boundary. If the BAR0_EN bit (bit 5 at C8h) is '0', then these bits are read-only and return zeros when read. If the BAR0_EN bit is '1', then these bits are read/write. |
| 11:4 | RSVD | R | Reserved. These bits are read-only and return 00h when read. |
| 3 | PRE_FETCH | R | Prefetchable. This bit is read-only 0b indicating that this memory window is not prefetchable. |
| 2:1 | MEM_TYPE | R | Memory type. This field is read-only 00b indicating that this window can be located anywhere in the 32-bit address space. |
| 0 | MEM_IND | R | Memory space indicator. This field returns 0b indicating that memory space is used. |

4.11 Scratchpad RAM Base Address

This register is used to program the memory address used to access the embedded scratchpad RAM.

PCI register offset: 14h
 Register type: Read-only, Read/Write

Default value: 0000 0000h

| | | | | | | | | | | | | | | | | |
|--------------------|-----------|-----------|-----------|-----------|-----------|-----------|-----------|-----------|-----------|-----------|-----------|-----------|-----------|-----------|-----------|-----------|
| BIT NUMBER | 31 | 30 | 29 | 28 | 27 | 26 | 25 | 24 | 23 | 22 | 21 | 20 | 19 | 18 | 17 | 16 |
| RESET STATE | 0 | 0 | 0 | 0 | 0 | 0 | 0 | 0 | 0 | 0 | 0 | 0 | 0 | 0 | 0 | 0 |

| | | | | | | | | | | | | | | | | |
|--------------------|-----------|-----------|-----------|-----------|-----------|-----------|----------|----------|----------|----------|----------|----------|----------|----------|----------|----------|
| BIT NUMBER | 15 | 14 | 13 | 12 | 11 | 10 | 9 | 8 | 7 | 6 | 5 | 4 | 3 | 2 | 1 | 0 |
| RESET STATE | 0 | 0 | 0 | 0 | 0 | 0 | 0 | 0 | 0 | 0 | 0 | 0 | 0 | 0 | 0 | 0 |

Table 4-6. Device Control Base Address Register Description

| BIT | FIELD NAME | ACCESS | DESCRIPTION |
|------------|-------------------|---------------|---|
| 31:12 | ADDRESS | R or RW | Memory Address. The memory address field for XIO2213A uses 20 read/write bits indicating that 4096 bytes of memory space are required. If the BAR1_EN bit (bit 6 at C8h) is '0', then these bits are read-only and return zeros when read. If the BAR1_EN bit is '1', then these bits are read/write. |
| 11:4 | RSVD | R | Reserved. These bits are read-only and return 00h when read. |
| 3 | PRE_FETCH | R | Prefetchable. This bit is read-only 0b indicating that this memory window is not prefetchable. |
| 2:1 | MEM_TYPE | R | Memory type. This field is read-only 00b indicating that this window can be located anywhere in the 32-bit address space. |
| 0 | MEM_IND | R | Memory space indicator. This field returns 0b indicating that memory space is used. |

4.12 Primary Bus Number Register

This read/write register specifies the bus number of the PCI bus segment that the PCI Express interface is connected to.

PCI register offset: 18h

Register type: Read/Write

Default value: 00h

| | | | | | | | | |
|--------------------|----------|----------|----------|----------|----------|----------|----------|----------|
| BIT NUMBER | 7 | 6 | 5 | 4 | 3 | 2 | 1 | 0 |
| RESET STATE | 0 | 0 | 0 | 0 | 0 | 0 | 0 | 0 |

4.13 Secondary Bus Number Register

This read/write register specifies the bus number of the PCI bus segment that the PCI interface is connected to. The bridge uses this register to determine how to respond to a type 1 configuration transaction.

PCI register offset: 19h

Register type: Read/Write

Default value: 00h

| | | | | | | | | |
|--------------------|----------|----------|----------|----------|----------|----------|----------|----------|
| BIT NUMBER | 7 | 6 | 5 | 4 | 3 | 2 | 1 | 0 |
| RESET STATE | 0 | 0 | 0 | 0 | 0 | 0 | 0 | 0 |

4.14 Subordinate Bus Number Register

This read/write register specifies the bus number of the highest number PCI bus segment that is downstream of the bridge. Since the PCI bus is internal and only connects to the 1394a OHCI, this register must always be equal to the secondary bus number register (offset 19h, see [Section 4.13](#)). The bridge uses this register to determine how to respond to a type 1 configuration transaction.

PCI register offset: 1Ah

Register type: Read/Write

Default value: 00h

| | | | | | | | | |
|--------------------|----------|----------|----------|----------|----------|----------|----------|----------|
| BIT NUMBER | 7 | 6 | 5 | 4 | 3 | 2 | 1 | 0 |
| RESET STATE | 0 | 0 | 0 | 0 | 0 | 0 | 0 | 0 |

4.15 Secondary Latency Timer Register

This read/write register specifies the secondary bus latency timer for the bridge, in units of PCI clock cycles.

PCI register offset: 1Bh

Register type: Read/Write

Default value: 00h

| | | | | | | | | |
|--------------------|----------|----------|----------|----------|----------|----------|----------|----------|
| BIT NUMBER | 7 | 6 | 5 | 4 | 3 | 2 | 1 | 0 |
| RESET STATE | 0 | 0 | 0 | 0 | 0 | 0 | 0 | 0 |

4.16 I/O Base Register

This read/write register specifies the lower limit of the I/O addresses that the bridge forwards downstream. See [Table 4-7](#) for a complete description of the register contents.

PCI register offset: 1Ch
 Register type: Read-only, Read/Write
 Default value: 01h

| BIT NUMBER | 7 | 6 | 5 | 4 | 3 | 2 | 1 | 0 |
|-------------|---|---|---|---|---|---|---|---|
| RESET STATE | 0 | 0 | 0 | 0 | 0 | 0 | 0 | 1 |

Table 4-7. I/O Base Register Description

| BIT | FIELD NAME | ACCESS | DESCRIPTION |
|-----|------------|--------|--|
| 7:4 | IOBASE | RW | I/O base. Defines the bottom address of the I/O address range that determines when to forward I/O transactions from one interface to the other. These bits correspond to address bits [15:12] in the I/O address. The lower 12 bits are assumed to be 000h. The 16 bits corresponding to address bits [31:16] of the I/O address are defined in the I/O base upper 16 bits register (offset 30h, see Section 4.25). |
| 3:0 | IOTYPE | R | I/O type. This field is read-only 1h indicating that the bridge supports 32-bit I/O addressing. |

4.17 I/O Limit Register

This read/write register specifies the upper limit of the I/O addresses that the bridge forwards downstream. See [Table 4-8](#) for a complete description of the register contents.

PCI register offset: 1Dh
 Register type: Read-only, Read/Write
 Default value: 01h

| BIT NUMBER | 7 | 6 | 5 | 4 | 3 | 2 | 1 | 0 |
|-------------|---|---|---|---|---|---|---|---|
| RESET STATE | 0 | 0 | 0 | 0 | 0 | 0 | 0 | 1 |

Table 4-8. I/O Limit Register Description

| BIT | FIELD NAME | ACCESS | DESCRIPTION |
|-----|------------|--------|---|
| 7:4 | IOLIMIT | RW | I/O limit. Defines the top address of the I/O address range that determines when to forward I/O transactions from one interface to the other. These bits correspond to address bits [15:12] in the I/O address. The lower 12 bits are assumed to be FFFh. The 16 bits corresponding to address bits [31:16] of the I/O address are defined in the I/O limit upper 16 bits register (offset 32h, see Section 4.26). |
| 3:0 | IOTYPE | R | I/O type. This field is read-only 1h indicating that the bridge supports 32-bit I/O addressing. |

4.18 Secondary Status Register

The secondary status register provides information about the PCI bus interface. See [Table 4-9](#) for a complete description of the register contents.

PCI register offset: 1Eh
 Register type: Read-only, Read/Clear
 Default value: 02X0h

| BIT NUMBER | 15 | 14 | 13 | 12 | 11 | 10 | 9 | 8 | 7 | 6 | 5 | 4 | 3 | 2 | 1 | 0 |
|-------------|----|----|----|----|----|----|---|---|---|---|---|---|---|---|---|---|
| RESET STATE | 0 | 0 | 0 | 0 | 0 | 0 | 1 | 0 | x | 0 | 0 | 0 | 0 | 0 | 0 | 0 |

Table 4-9. Secondary Status Register Description

| BIT | FIELD NAME | ACCESS | DESCRIPTION |
|------|------------|--------|--|
| 15 | PAR_ERR | RCU | <p>Detected parity error. This bit reports the detection of an uncorrectable address, attribute, or data error by the bridge on its internal PCI bus secondary interface. This bit must be set when any of the following three conditions are true:</p> <ul style="list-style-type: none"> The bridge detects an uncorrectable address or attribute error as a potential target. The bridge detects an uncorrectable data error when it is the target of a write transaction. The bridge detects an uncorrectable data error when it is the master of a read transaction (immediate read data). <p>The bit is set irrespective of the state of bit 0 (PERR_EN) in the bridge control register at offset 3Eh (see Section 4.30).</p> <p>0 = Uncorrectable address, attribute, or data error not detected on secondary interface 1 = Uncorrectable address, attribute, or data error detected on secondary interface</p> |
| 14 | SYS_ERR | RCU | <p>Received system error. This bit is set when the bridge detects an $\overline{\text{SERR}}$ assertion.</p> <p>0 = No error asserted on the PCI interface 1 = SERR asserted on the PCI interface</p> |
| 13 | MABORT | RCU | <p>Received master abort. This bit is set when the PCI interface of the bridge reports the detection of a master abort termination by the bridge when it is the master of a transaction on its secondary interface.</p> <p>0 = Master abort not received on the PCI interface 1 = Master abort received on the PCI interface</p> |
| 12 | TABORT_REC | RCU | <p>Received target abort. This bit is set when the PCI interface of the bridge receives a target abort.</p> <p>0 = Target abort not received on the PCI interface 1 = Target abort received on the PCI interface</p> |
| 11 | TABORT_SIG | RCU | <p>Signaled target abort. This bit reports the signaling of a target abort termination by the bridge when it responds as the target of a transaction on its secondary interface.</p> <p>0 = Target abort not signaled on the PCI interface 1 = Target abort signaled on the PCI interface</p> |
| 10:9 | PCI_SPEED | R | <p>DEVSEL timing. These bits are 01b indicating that this is a medium speed decoding device.</p> |
| 8 | DATAPAR | RCU | <p>Master data parity error. This bit is set if the bridge is the bus master of the transaction on the PCI bus, bit 0 (PERR_EN) in the bridge control register (offset 3Eh see Section 4.30) is set, and the bridge either asserts PERR on a read transaction or detects PERR asserted on a write transaction.</p> <p>0 = No data parity error detected on the PCI interface 1 = Data parity error detected on the PCI interface</p> |
| 7 | FBB_CAP | R | <p>Fast back-to-back capable. This bit returns a 1b when read indicating that the secondary PCI interface of bridge supports fast back-to-back transactions.</p> |
| 6 | RSVD | R | <p>Reserved. Returns 0b when read.</p> |
| 5 | 66MHZ | R | <p>66-MHz capable. The bridge operates at a PCI bus CLK frequency of 66 MHz; therefore, this bit always returns a 1b.</p> |
| 4:0 | RSVD | R | <p>Reserved. Returns 00000b when read.</p> |

4.19 Memory Base Register

This read/write register specifies the lower limit of the memory addresses that the bridge forwards downstream. See [Table 4-10](#) for a complete description of the register contents.

PCI register offset: 20h
 Register type: Read-only, Read/Write
 Default value: 0000h

| BIT NUMBER | 15 | 14 | 13 | 12 | 11 | 10 | 9 | 8 | 7 | 6 | 5 | 4 | 3 | 2 | 1 | 0 |
|-------------|----|----|----|----|----|----|---|---|---|---|---|---|---|---|---|---|
| RESET STATE | 0 | 0 | 0 | 0 | 0 | 0 | 0 | 0 | 0 | 0 | 0 | 0 | 0 | 0 | 0 | 0 |

Table 4-10. Memory Base Register Description

| BIT | FIELD NAME | ACCESS | DESCRIPTION |
|------|------------|--------|---|
| 15:4 | MEMBASE | RW | Memory base. Defines the lowest address of the memory address range that determines when to forward memory transactions from one interface to the other. These bits correspond to address bits [31:20] in the memory address. The lower 20 bits are assumed to be 00000h. |
| 3:0 | RSVD | R | Reserved. Returns 0h when read. |

4.20 Memory Limit Register

This read/write register specifies the upper limit of the memory addresses that the bridge forwards downstream. See [Table 4-11](#) for a complete description of the register contents.

PCI register offset: 22h
 Register type: Read-only, Read/Write
 Default value: 0000h

| BIT NUMBER | 15 | 14 | 13 | 12 | 11 | 10 | 9 | 8 | 7 | 6 | 5 | 4 | 3 | 2 | 1 | 0 |
|-------------|----|----|----|----|----|----|---|---|---|---|---|---|---|---|---|---|
| RESET STATE | 0 | 0 | 0 | 0 | 0 | 0 | 0 | 0 | 0 | 0 | 0 | 0 | 0 | 0 | 0 | 0 |

Table 4-11. Memory Limit Register Description

| BIT | FIELD NAME | ACCESS | DESCRIPTION |
|------|------------|--------|--|
| 15:4 | MEMLIMIT | RW | Memory limit. Defines the highest address of the memory address range that determines when to forward memory transactions from one interface to the other. These bits correspond to address bits [31:20] in the memory address. The lower 20 bits are assumed to be FFFFh. |
| 3:0 | RSVD | R | Reserved. Returns 0h when read. |

4.21 Prefetchable Memory Base Register

This read/write register specifies the lower limit of the prefetchable memory addresses that the bridge forwards downstream. See [Table 4-12](#) for a complete description of the register contents.

PCI register offset: 24h
 Register type: Read-only, Read/Write
 Default value: 0001h

| BIT NUMBER | 15 | 14 | 13 | 12 | 11 | 10 | 9 | 8 | 7 | 6 | 5 | 4 | 3 | 2 | 1 | 0 |
|-------------|----|----|----|----|----|----|---|---|---|---|---|---|---|---|---|---|
| RESET STATE | 0 | 0 | 0 | 0 | 0 | 0 | 0 | 0 | 0 | 0 | 0 | 0 | 0 | 0 | 0 | 1 |

Table 4-12. Prefetchable Memory Base Register Description

| BIT | FIELD NAME | ACCESS | DESCRIPTION |
|------|------------|--------|---|
| 15:4 | PREBASE | RW | Prefetchable memory base. Defines the lowest address of the prefetchable memory address range that determines when to forward memory transactions from one interface to the other. These bits correspond to address bits [31:20] in the memory address. The lower 20 bits are assumed to be 00000h. The prefetchable base upper 32 bits register (offset 28h, see Section 4.23) specifies the bit [63:32] of the 64-bit prefetchable memory address. |

Table 4-12. Prefetchable Memory Base Register Description (continued)

| BIT | FIELD NAME | ACCESS | DESCRIPTION |
|-----|------------|--------|--|
| 3:0 | 64BIT | R | 64-bit memory indicator. These read-only bits indicate that 64-bit addressing is supported for this memory window. |

4.22 Prefetchable Memory Limit Register

This read/write register specifies the upper limit of the prefetchable memory addresses that the bridge forwards downstream. See [Table 4-13](#) for a complete description of the register contents.

PCI register offset: 26h
Register type: Read-only, Read/Write
Default value: 0001h

| BIT NUMBER | 15 | 14 | 13 | 12 | 11 | 10 | 9 | 8 | 7 | 6 | 5 | 4 | 3 | 2 | 1 | 0 |
|-------------|----|----|----|----|----|----|---|---|---|---|---|---|---|---|---|---|
| RESET STATE | 0 | 0 | 0 | 0 | 0 | 0 | 0 | 0 | 0 | 0 | 0 | 0 | 0 | 0 | 0 | 1 |

Table 4-13. Prefetchable Memory Limit Register Description

| BIT | FIELD NAME | ACCESS | DESCRIPTION |
|------|------------|--------|---|
| 15:4 | PRELIMIT | RW | Prefetchable memory limit. Defines the highest address of the prefetchable memory address range that determines when to forward memory transactions from one interface to the other. These bits correspond to address bits [31:20] in the memory address. The lower 20 bits are assumed to be FFFFh. The prefetchable limit upper 32 bits register (offset 2Ch, see Section 4.24) specifies the bit [63:32] of the 64-bit prefetchable memory address. |
| 3:0 | 64BIT | R | 64-bit memory indicator. These read-only bits indicate that 64-bit addressing is supported for this memory window. |

4.23 Prefetchable Base Upper 32 Bits Register

This read/write register specifies the upper 32 bits of the prefetchable memory base register. See [Table 4-14](#) for a complete description of the register contents.

PCI register offset: 28h
Register type: Read/Write
Default value: 0000 0000h

| BIT NUMBER | 31 | 30 | 29 | 28 | 27 | 26 | 25 | 24 | 23 | 22 | 21 | 20 | 19 | 18 | 17 | 16 |
|-------------|----|----|----|----|----|----|----|----|----|----|----|----|----|----|----|----|
| RESET STATE | 0 | 0 | 0 | 0 | 0 | 0 | 0 | 0 | 0 | 0 | 0 | 0 | 0 | 0 | 0 | 0 |

| BIT NUMBER | 15 | 14 | 13 | 12 | 11 | 10 | 9 | 8 | 7 | 6 | 5 | 4 | 3 | 2 | 1 | 0 |
|-------------|----|----|----|----|----|----|---|---|---|---|---|---|---|---|---|---|
| RESET STATE | 0 | 0 | 0 | 0 | 0 | 0 | 0 | 0 | 0 | 0 | 0 | 0 | 0 | 0 | 0 | 0 |

Table 4-14. Prefetchable Base Upper 32 Bits Register Description

| BIT | FIELD NAME | ACCESS | DESCRIPTION |
|------|------------|--------|--|
| 31:0 | PREBASE | RW | Prefetchable memory base upper 32 bits. Defines the upper 32 bits of the lowest address of the prefetchable memory address range that determines when to forward memory transactions downstream. |

4.24 Prefetchable Limit Upper 32 Bits Register

This read/write register specifies the upper 32 bits of the prefetchable memory limit register. See [Table 4-15](#) for a complete description of the register contents.

PCI register offset: 2Ch
Register type: Read/Write
Default value: 0000 0000h

| | | | | | | | | | | | | | | | | |
|--------------------|-----------|-----------|-----------|-----------|-----------|-----------|-----------|-----------|-----------|-----------|-----------|-----------|-----------|-----------|-----------|-----------|
| BIT NUMBER | 31 | 30 | 29 | 28 | 27 | 26 | 25 | 24 | 23 | 22 | 21 | 20 | 19 | 18 | 17 | 16 |
| RESET STATE | 0 | 0 | 0 | 0 | 0 | 0 | 0 | 0 | 0 | 0 | 0 | 0 | 0 | 0 | 0 | 0 |

| | | | | | | | | | | | | | | | | |
|--------------------|-----------|-----------|-----------|-----------|-----------|-----------|----------|----------|----------|----------|----------|----------|----------|----------|----------|----------|
| BIT NUMBER | 15 | 14 | 13 | 12 | 11 | 10 | 9 | 8 | 7 | 6 | 5 | 4 | 3 | 2 | 1 | 0 |
| RESET STATE | 0 | 0 | 0 | 0 | 0 | 0 | 0 | 0 | 0 | 0 | 0 | 0 | 0 | 0 | 0 | 0 |

Table 4-15. Prefetchable Limit Upper 32 Bits Register Description

| BIT | FIELD NAME | ACCESS | DESCRIPTION |
|------|------------|--------|--|
| 31:0 | PRELIMIT | RW | Prefetchable memory limit upper 32 bits. Defines the upper 32 bits of the highest address of the prefetchable memory address range that determines when to forward memory transactions downstream. |

4.25 I/O Base Upper 16 Bits Register

This read/write register specifies the upper 16 bits of the I/O base register. See [Table 4-16](#) for a complete description of the register contents.

PCI register offset: 30h
 Register type: Read/Write
 Default value: 0000h

| | | | | | | | | | | | | | | | | |
|--------------------|-----------|-----------|-----------|-----------|-----------|-----------|----------|----------|----------|----------|----------|----------|----------|----------|----------|----------|
| BIT NUMBER | 15 | 14 | 13 | 12 | 11 | 10 | 9 | 8 | 7 | 6 | 5 | 4 | 3 | 2 | 1 | 0 |
| RESET STATE | 0 | 0 | 0 | 0 | 0 | 0 | 0 | 0 | 0 | 0 | 0 | 0 | 0 | 0 | 0 | 0 |

Table 4-16. I/O Base Upper 16 Bits Register Description

| BIT | FIELD NAME | ACCESS | DESCRIPTION |
|------|------------|--------|---|
| 15:0 | IOBASE | RW | I/O base upper 16 bits. Defines the upper 16 bits of the lowest address of the I/O address range that determines when to forward I/O transactions downstream. These bits correspond to address bits [31:20] in the I/O address. The lower 20 bits are assumed to be 00000h. |

4.26 I/O Limit Upper 16 Bits Register

This read/write register specifies the upper 16 bits of the I/O limit register. See [Table 4-17](#) for a complete description of the register contents.

PCI register offset: 32h
 Register type: Read/Write
 Default value: 0000h

| | | | | | | | | | | | | | | | | |
|--------------------|-----------|-----------|-----------|-----------|-----------|-----------|----------|----------|----------|----------|----------|----------|----------|----------|----------|----------|
| BIT NUMBER | 15 | 14 | 13 | 12 | 11 | 10 | 9 | 8 | 7 | 6 | 5 | 4 | 3 | 2 | 1 | 0 |
| RESET STATE | 0 | 0 | 0 | 0 | 0 | 0 | 0 | 0 | 0 | 0 | 0 | 0 | 0 | 0 | 0 | 0 |

Table 4-17. I/O Limit Upper 16 Bits Register Description

| BIT | FIELD NAME | ACCESS | DESCRIPTION |
|------|------------|--------|--|
| 15:0 | IOLIMIT | RW | I/O limit upper 16 bits. Defines the upper 16 bits of the top address of the I/O address range that determines when to forward I/O transactions downstream. These bits correspond to address bits [31:20] in the I/O address. The lower 20 bits are assumed to be FFFFh. |

4.27 Capabilities Pointer Register

This read-only register provides a pointer into the PCI configuration header where the PCI power management block resides. Since the PCI power management registers begin at 50h, this register is hardwired to 50h.

PCI register offset: 34h
 Register type: Read-only

Default value: 50h

| BIT NUMBER | 7 | 6 | 5 | 4 | 3 | 2 | 1 | 0 |
|-------------|---|---|---|---|---|---|---|---|
| RESET STATE | 0 | 1 | 0 | 1 | 0 | 0 | 0 | 0 |

4.28 Interrupt Line Register

This read/write register is programmed by the system and indicates to the software which interrupt line the bridge has assigned to it. The default value of this register is FFh, indicating that an interrupt line has not yet been assigned to the function. Since the bridge does not generate interrupts internally, this register is a scratch pad register.

PCI register offset: 3Ch

Register type: Read/Write

Default value: FFh

| BIT NUMBER | 7 | 6 | 5 | 4 | 3 | 2 | 1 | 0 |
|-------------|---|---|---|---|---|---|---|---|
| RESET STATE | 1 | 1 | 1 | 1 | 1 | 1 | 1 | 1 |

4.29 Interrupt Pin Register

The interrupt pin register is read-only 00h indicating that the bridge does not generate internal interrupts. While the bridge does not generate internal interrupts, it does forward interrupts from the secondary interface to the primary interface.

PCI register offset: 3Dh

Register type: Read-only

Default value: 00h

| BIT NUMBER | 7 | 6 | 5 | 4 | 3 | 2 | 1 | 0 |
|-------------|---|---|---|---|---|---|---|---|
| RESET STATE | 0 | 0 | 0 | 0 | 0 | 0 | 0 | 0 |

4.30 Bridge Control Register

The bridge control register provides extensions to the command register that are specific to a bridge. See [Table 4-18](#) for a complete description of the register contents.

PCI register offset: 3Eh
 Register type: Read-only, Read/Write, Read/Clear
 Default value: 0000h

| BIT NUMBER | 15 | 14 | 13 | 12 | 11 | 10 | 9 | 8 | 7 | 6 | 5 | 4 | 3 | 2 | 1 | 0 |
|-------------|----|----|----|----|----|----|---|---|---|---|---|---|---|---|---|---|
| RESET STATE | 0 | 0 | 0 | 0 | 0 | 0 | 0 | 0 | 0 | 0 | 0 | 0 | 0 | 0 | 0 | 0 |

Table 4-18. Bridge Control Register Description

| BIT | FIELD NAME | ACCESS | DESCRIPTION |
|-------|------------|--------|--|
| 15:12 | RSVD | R | Reserved. Returns 0h when read. |
| 11 | DTSERR | RW | Discard timer \overline{SERR} enable. Applies only in conventional PCI mode. This bit enables the bridge to generate either an ERR_NONFATAL (by default) or ERR_FATAL transaction on the primary interface when the secondary discard timer expires and a delayed transaction is discarded from a queue in the bridge. The severity is selectable only if advanced error reporting is supported. 0 = Do not generate ERR_NONFATAL or ERR_FATAL on the primary interface as a result of the expiration of the secondary discard timer. Note that an error message can still be sent if advanced error reporting is supported and bit 10 (DISCARD_TIMER_MASK) in the secondary uncorrectable error mask register (offset 130h, see Section 5.11) is clear (default). 1 = Generate ERR_NONFATAL or ERR_FATAL on the primary interface if the secondary discard timer expires and a delayed transaction is discarded from a queue in the bridges. |
| 10 | DTSTATUS | RCU | Discard timer status. This bit indicates if a discard timer expires and a delayed transaction is discarded. 0 = No discard timer error 1 = Discard timer error |
| 9 | SEC_DT | | RW Selects the number of PCI clocks that the bridge waits for the 1394a OHCI master on the secondary interface to repeat a delayed transaction request. The counter starts once the delayed completion (the completion of the delayed transaction on the primary interface) has reached the head of the downstream queue of the bridge (i.e., all ordering requirements have been satisfied and the bridge is ready to complete the delayed transaction with the initiating master on the secondary bus). If the master does not repeat the transaction before the counter expires, then the bridge deletes the delayed transaction from its queue and sets the discard timer status bit. 0 = The secondary discard timer counts 2^{15} PCI clock cycles (default) 1 = The secondary discard timer counts 2^{10} PCI clock cycles |
| 8 | PRI_DEC | R | Primary discard timer. This bit has no meaning in PCI Express and is hardwired to 0b. |
| 7 | FBB_EN | RW | Fast back-to-back enable. This bit allows software to enable fast back-to-back transactions on the secondary PCI interface. 0 = Fast back-to-back transactions are disabled (default) 1 = Secondary interface fast back-to-back transactions are enabled |
| 6 | SRST | RW | Secondary bus reset. This bit is set when software wishes to reset all devices downstream of the bridge. Setting this bit causes the PRST signal on the secondary interface to be asserted. 0 = Secondary interface is not in reset state (default) 1 = Secondary interface is in the reset state |

Table 4-18. Bridge Control Register Description (continued)

| BIT | FIELD NAME | ACCESS | DESCRIPTION |
|-----|------------|--------|--|
| 5 | MAM | RW | <p>Master abort mode. This bit controls the behavior of the bridge when it receives a master abort or an unsupported request.</p> <p>0 = Do not report master aborts. Returns FFFF FFFFh on reads and discard data on writes (default)</p> <p>1 = Respond with an unsupported request on PCI Express when a master abort is received on PCI. Respond with target abort on PCI when an unsupported request completion on PCI Express is received. This bit also enables error signaling on master abort conditions on posted writes.</p> |
| 4 | VGA16 | RW | <p>VGA 16-bit decode. This bit enables the bridge to provide full 16-bit decoding for VGA I/O addresses. This bit only has meaning if the VGA enable bit is set.</p> <p>0 = Ignore address bits [15:10] when decoding VGA I/O addresses (default)</p> <p>1 = Decode address bits [15:10] when decoding VGA I/O addresses</p> |
| 3 | VGA | RW | <p>VGA enable. This bit modifies the response by the bridge to VGA compatible addresses. If this bit is set, then the bridge decodes and forwards the following accesses on the primary interface to the secondary interface (and, conversely, block the forwarding of these addresses from the secondary to primary interface):</p> <ul style="list-style-type: none"> • Memory accesses in the range 000A 0000h to 000B FFFFh • I/O addresses in the first 64 KB of the I/O address space (address bits [31:16] are 0000h) and where address bits [9:0] are in the range of 3B0h to 3BBh or 3C0h to 3DFh (inclusive of ISA address aliases – address bits [15:10] may possess any value and are not used in the decoding) <p>If this bit is set, then forwarding of VGA addresses is independent of the value of bit 2 (ISA), the I/O address and memory address ranges defined by the I/O base and limit registers, the memory base and limit registers, and the prefetchable memory base and limit registers of the bridge. The forwarding of VGA addresses is qualified by bits 0 (IO_ENB) and 1 (MEMORY_ENB) in the command register (offset 04h, see Section 4.3).</p> <p>0 = Do not forward VGA compatible memory and I/O addresses from the primary to secondary interface (addresses defined above) unless they are enabled for forwarding by the defined I/O and memory address ranges (default).</p> <p>1 = Forward VGA compatible memory and I/O addresses (addresses defined above) from the primary interface to the secondary interface (if the I/O enable and memory enable bits are set) independent of the I/O and memory address ranges and independent of the ISA enable bit.</p> |
| 2 | ISA | RW | <p>ISA enable. This bit modifies the response by the bridge to ISA I/O addresses. This applies only to I/O addresses that are enabled by the I/O base and I/O limit registers and are in the first 64 KB of PCI I/O address space (0000 0000h to 0000 FFFFh). If this bit is set, then the bridge blocks any forwarding from primary to secondary of I/O transactions addressing the last 768 bytes in each 1-KB block. In the opposite direction (secondary to primary), I/O transactions are forwarded if they address the last 768 bytes in each 1K block.</p> <p>0 = Forward downstream all I/O addresses in the address range defined by the I/O base and I/O limit registers (default)</p> <p>1 = Forward upstream ISA I/O addresses in the address range defined by the I/O base and I/O limit registers that are in the first 64 KB of PCI I/O address space (top 768 bytes of each 1-KB block)</p> |
| 1 | SERR_EN | RW | <p>SERR enable. This bit controls forwarding of system error events from the secondary interface to the primary interface. The bridge forwards system error events when:</p> <ul style="list-style-type: none"> • This bit is set • Bit 8 (SERR_ENB) in the command register (offset 04h, see Section 4.3) is set • $\overline{\text{SERR}}$ is asserted on the secondary interface <p>0 = Disable the forwarding of system error events (default)</p> <p>1 = Enable the forwarding of system error events</p> |

Table 4-18. Bridge Control Register Description (continued)

| BIT | FIELD NAME | ACCESS | DESCRIPTION |
|-----|------------|--------|---|
| 0 | PERR_EN | RW | Parity error response enable. Controls the bridge's response to data, uncorrectable address, and attribute errors on the secondary interface. Also, the bridge always forwards data with poisoning, from conventional PCI to PCI Express on an uncorrectable conventional PCI data error, regardless of the setting of this bit. 0 = Ignore uncorrectable address, attribute, and data errors on the secondary interface (default) 1 = Enable uncorrectable address, attribute, and data error detection and reporting on the secondary interface |

4.31 Capability ID Register

This read-only register identifies the linked list item as the register for PCI power management. The register returns 01h when read.

PCI register offset: 50h

Register type: Read-only

Default value: 01h

| BIT NUMBER | 7 | 6 | 5 | 4 | 3 | 2 | 1 | 0 |
|-------------|---|---|---|---|---|---|---|---|
| RESET STATE | 0 | 0 | 0 | 0 | 0 | 0 | 0 | 1 |

4.32 Next Item Pointer Register

The contents of this read-only register indicate the next item in the linked list of capabilities for the bridge. This register reads 80h pointing to the Subsystem ID capabilities registers.

PCI register offset: 51h

Register type: Read-only

Default value: 60h

| BIT NUMBER | 7 | 6 | 5 | 4 | 3 | 2 | 1 | 0 |
|-------------|---|---|---|---|---|---|---|---|
| RESET STATE | 0 | 1 | 1 | 0 | 0 | 0 | 0 | 0 |

4.33 Power Management Capabilities Register

This read-only register indicates the capabilities of the bridge related to PCI power management. See [Table 4-19](#) for a complete description of the register contents.

PCI register offset: 52h

Register type: Read-only

Default value: 0603h

| BIT NUMBER | 15 | 14 | 13 | 12 | 11 | 10 | 9 | 8 | 7 | 6 | 5 | 4 | 3 | 2 | 1 | 0 |
|-------------|----|----|----|----|----|----|---|---|---|---|---|---|---|---|---|---|
| RESET STATE | 0 | 0 | 0 | 0 | 0 | 1 | 1 | 0 | 0 | 0 | 0 | 0 | 0 | 0 | 1 | 1 |

Table 4-19. Power Management Capabilities Register Description

| BIT | FIELD NAME | ACCESS | DESCRIPTION |
|-------|-------------|--------|---|
| 15:11 | PME_SUPPORT | R | PME support. This 5-bit field indicates the power states from which the bridge may assert PME. Because the bridge never generates a PME except on a behalf of a secondary device, this field is read-only and returns 00000b. |
| 10 | D2_SUPPORT | R | This bit returns a 1b when read, indicating that the function supports the D2 device power state. |
| 9 | D1_SUPPORT | R | This bit returns a 1b when read, indicating that the function supports the D1 device power state. |
| 8:6 | AUX_CURRENT | R | 3.3 V _{AUX} auxiliary current requirements. This field returns 000b since the bridge does not generate PME from D3 _{cold} . |

Table 4-19. Power Management Capabilities Register Description (continued)

| BIT | FIELD NAME | ACCESS | DESCRIPTION |
|-----|------------|--------|--|
| 5 | DSI | R | Device specific initialization. This bit returns 0b when read, indicating that the bridge does not require special initialization beyond the standard PCI configuration header before a generic class driver is able to use it. |
| 4 | RSVD | R | Reserved. Returns 0b when read. |
| 3 | PME_CLK | R | $\overline{\text{PME}}$ clock. This bit returns 0b indicating that the PCI clock is not needed to generate $\overline{\text{PME}}$. |
| 2:0 | PM_VERSION | R | Power management version. If bit 26 (PCI_PM_VERSION_CTRL) in the general control register (offset D4h, see Section 4.66) is 0b, then this field returns 010b indicating revision 1.1 compatibility. If PCI_PM_VERSION_CTRL is 1b, then this field returns 011b indicating revision 1.2 compatibility. |

4.34 Power Management Control/Status Register

This register determines and changes the current power state of the bridge. No internal reset is generated when transitioning from the D3_{hot} state to the D0 state. See [Table 4-20](#) for a complete description of the register contents.

PCI register offset: 54h
Register type: Read-only, Read/Write
Default value: 0008h

| BIT NUMBER | 15 | 14 | 13 | 12 | 11 | 10 | 9 | 8 | 7 | 6 | 5 | 4 | 3 | 2 | 1 | 0 |
|-------------|----|----|----|----|----|----|---|---|---|---|---|---|---|---|---|---|
| RESET STATE | 0 | 0 | 0 | 0 | 0 | 0 | 0 | 0 | 0 | 0 | 0 | 0 | 1 | 0 | 0 | 0 |

Table 4-20. Power Management Control/Status Register Description

| BIT | FIELD NAME | ACCESS | DESCRIPTION |
|-------|---------------|--------|--|
| 15 | PME_STAT | R | $\overline{\text{PME}}$ status. This bit is read-only and returns 0b when read. |
| 14:13 | DATA_SCALE | R | Data scale. This 2-bit field returns 00b when read since the bridge does not use the data register. |
| 12:9 | DATA_SEL | R | Data select. This 4-bit field returns 0h when read since the bridge does not use the data register. |
| 8 | PME_EN | RW | $\overline{\text{PME}}$ enable. This bit has no function and acts as scratchpad space. The default value for this bit is 0b. |
| 7:4 | RSVD | R | Reserved. Returns 0h when read. |
| 3 | NO_SOFT_RESET | R | No soft reset. If bit 26 (PCI_PM_VERSION_CTRL) in the general control register (offset D4h, see Section 4.66) is 0b, then this bit returns 0b for compatibility with version 1.1 of the <i>PCI Power Management Specification</i> . If PCI_PM_VERSION_CTRL is 1b, then this bit returns 1b indicating that no internal reset is generated and the device retains its configuration context when transitioning from the D3 _{hot} state to the D0 state. |
| 2 | RSVD | R | Reserved. Returns 0b when read. |
| 1:0 | PWR_STATE | RW | Power state. This 2-bit field determines the current power state of the function and sets the function into a new power state. This field is encoded as follows: 00 = D0 (default) 01 = D1 10 = D2 11 = D3 _{hot} |

4.35 Power Management Bridge Support Extension Register

This read-only register indicates to host software what the state of the secondary bus will be when the bridge is placed in D3. See [Table 4-21](#) for a complete description of the register contents.

PCI register offset: 56h
Register type: Read-only
Default value: 40h

| | | | | | | | | |
|--------------------|----------|----------|----------|----------|----------|----------|----------|----------|
| BIT NUMBER | 7 | 6 | 5 | 4 | 3 | 2 | 1 | 0 |
| RESET STATE | 0 | 1 | 0 | 0 | 0 | 0 | 0 | 0 |

Table 4-21. PM Bridge Support Extension Register Description

| BIT | FIELD NAME | ACCESS | DESCRIPTION |
|-----|------------|--------|--|
| 7 | BPCC | R | Bus power/clock control enable. This bit indicates to the host software if the bus secondary clocks are stopped when the bridge is placed in D3. The state of the BPCC bit is controlled by bit 11 (BPCC_E) in the general control register (offset D4h, see Section 4.66). 0 = The secondary bus clocks are not stopped in D3 1 = The secondary bus clocks are stopped in D3 |
| 6 | BSTATE | R | B2/B3 support. This bit is read-only 1b indicating that the bus state in D3 is B2. |
| 5:0 | RSVD | R | Reserved. Returns 00 0000b when read. |

4.36 Power Management Data Register

The read-only register is not applicable to the bridge and returns 00h when read.

PCI register offset: 57h

Register type: Read-only

Default value: 00h

| | | | | | | | | |
|--------------------|----------|----------|----------|----------|----------|----------|----------|----------|
| BIT NUMBER | 7 | 6 | 5 | 4 | 3 | 2 | 1 | 0 |
| RESET STATE | 0 | 0 | 0 | 0 | 0 | 0 | 0 | 0 |

4.37 MSI Capability ID Register

This read-only register identifies the linked list item as the register for message signaled interrupts capabilities. The register returns 05h when read.

PCI register offset: 60h

Register type: Read-only

Default value: 05h

| | | | | | | | | |
|--------------------|----------|----------|----------|----------|----------|----------|----------|----------|
| BIT NUMBER | 7 | 6 | 5 | 4 | 3 | 2 | 1 | 0 |
| RESET STATE | 0 | 0 | 0 | 0 | 0 | 1 | 0 | 1 |

4.38 Next Item Pointer Register

The contents of this read-only register indicate the next item in the linked list of capabilities for the bridge. This register reads 80h pointing to the subsystem ID capabilities registers.

PCI register offset: 61h

Register type: Read-only

Default value: 80h

| | | | | | | | | |
|--------------------|----------|----------|----------|----------|----------|----------|----------|----------|
| BIT NUMBER | 7 | 6 | 5 | 4 | 3 | 2 | 1 | 0 |
| RESET STATE | 1 | 0 | 0 | 0 | 0 | 0 | 0 | 0 |

4.39 MSI Message Control Register

This register controls the sending of MSI messages. See [Table 4-22](#) for a complete description of the register contents.

PCI register offset: 62h
Register type: Read-only, Read/Write
Default value: 0088h

| BIT NUMBER | 15 | 14 | 13 | 12 | 11 | 10 | 9 | 8 | 7 | 6 | 5 | 4 | 3 | 2 | 1 | 0 |
|-------------|----|----|----|----|----|----|---|---|---|---|---|---|---|---|---|---|
| RESET STATE | 0 | 0 | 0 | 0 | 0 | 0 | 0 | 0 | 1 | 0 | 0 | 0 | 1 | 0 | 0 | 0 |

Table 4-22. MSI Message Control Register Description

| BIT | FIELD NAME | ACCESS | DESCRIPTION |
|------|------------|--------|---|
| 15:8 | RSVD | R | Reserved. Returns 00h when read. |
| 7 | 64CAP | R | 64-bit message capability. This bit is read-only 1b indicating that the bridge supports 64-bit MSI message addressing. |
| 6:4 | MM_EN | RW | Multiple message enable. This bit indicates the number of distinct messages that the bridge is allowed to generate. 000 = 1 message (default) 001 = 2 messages 010 = 4 messages 011 = 8 messages 100 = 16 messages 101 = Reserved 110 = Reserved 111 = Reserved |
| 3:1 | MM_CAP | R | Multiple message capabilities. This field indicates the number of distinct messages that bridge is capable of generating. This field is read-only 100b indicating that the bridge can signal 1 interrupt for each IRQ supported on the serial IRQ stream up to a maximum of 16 unique interrupts. |
| 0 | MSI_EN | RW | MSI enable. This bit enables MSI interrupt signaling. MSI signaling must be enabled by software for the bridge to signal that a serial IRQ has been detected. 0 = MSI signaling is prohibited (default) 1 = MSI signaling is enabled |

NOTE

Enabling MSI messaging in the XIO2213A has no effect.

4.40 MSI Message Lower Address Register

This register contains the lower 32 bits of the address that a MSI message writes to when a serial IRQ is detected. See [Table 4-23](#) for a complete description of the register contents.

PCI register offset: 64h
Register type: Read-only, Read/Write
Default value: 0000 0000h

| BIT NUMBER | 31 | 30 | 29 | 28 | 27 | 26 | 25 | 24 | 23 | 22 | 21 | 20 | 19 | 18 | 17 | 16 |
|-------------|----|----|----|----|----|----|----|----|----|----|----|----|----|----|----|----|
| RESET STATE | 0 | 0 | 0 | 0 | 0 | 0 | 0 | 0 | 0 | 0 | 0 | 0 | 0 | 0 | 0 | 0 |

| BIT NUMBER | 15 | 14 | 13 | 12 | 11 | 10 | 9 | 8 | 7 | 6 | 5 | 4 | 3 | 2 | 1 | 0 |
|-------------|----|----|----|----|----|----|---|---|---|---|---|---|---|---|---|---|
| RESET STATE | 0 | 0 | 0 | 0 | 0 | 0 | 0 | 0 | 0 | 0 | 0 | 0 | 0 | 0 | 0 | 0 |

Table 4-23. MSI Message Lower Address Register Description

| BIT | FIELD NAME | ACCESS | DESCRIPTION |
|------|------------|--------|----------------------------------|
| 31:2 | ADDRESS | RW | System specified message address |
| 1:0 | RSVD | R | Reserved. Returns 00b when read. |

NOTE

Enabling MSI messaging in the XIO2213A has no effect.

4.41 MSI Message Upper Address Register

This register contains the upper 32 bits of the address that a MSI message writes to when a serial IRQ is detected. If this register contains 0000 0000h, then 32-bit addressing is used; otherwise, 64-bit addressing is used.

PCI register offset: 68h
 Register type: Read/Write
 Default value: 0000 0000h

| BIT NUMBER | 31 | 30 | 29 | 28 | 27 | 26 | 25 | 24 | 23 | 22 | 21 | 20 | 19 | 18 | 17 | 16 |
|-------------|----|----|----|----|----|----|----|----|----|----|----|----|----|----|----|----|
| RESET STATE | 0 | 0 | 0 | 0 | 0 | 0 | 0 | 0 | 0 | 0 | 0 | 0 | 0 | 0 | 0 | 0 |

| BIT NUMBER | 15 | 14 | 13 | 12 | 11 | 10 | 9 | 8 | 7 | 6 | 5 | 4 | 3 | 2 | 1 | 0 |
|-------------|----|----|----|----|----|----|---|---|---|---|---|---|---|---|---|---|
| RESET STATE | 0 | 0 | 0 | 0 | 0 | 0 | 0 | 0 | 0 | 0 | 0 | 0 | 0 | 0 | 0 | 0 |

NOTE

Enabling MSI messaging in the XIO2213A has no effect.

4.42 MSI Message Data Register

This register contains the data that software programmed the bridge to send when it send a MSI message. See [Table 4-24](#) for a complete description of the register contents.

PCI register offset: 6Ch
 Register type: Read/Write
 Default value: 0000h

| BIT NUMBER | 15 | 14 | 13 | 12 | 11 | 10 | 9 | 8 | 7 | 6 | 5 | 4 | 3 | 2 | 1 | 0 |
|-------------|----|----|----|----|----|----|---|---|---|---|---|---|---|---|---|---|
| RESET STATE | 0 | 0 | 0 | 0 | 0 | 0 | 0 | 0 | 0 | 0 | 0 | 0 | 0 | 0 | 0 | 0 |

Table 4-24. MSI Message Data Register Description

| BIT | FIELD NAME | ACCESS | DESCRIPTION |
|------|------------|--------|---|
| 15:4 | MSG | RW | System specific message. This field contains the portion of the message that the bridge forwards unmodified. |
| 3:0 | MSG_NUM | RW | <p>Message number. This portion of the message field may be modified to contain the message number is multiple messages are enable. The number of bits that are modifiable depends on the number of messages enabled in the message control register.</p> <p>1 message = No message data bits can be modified (default) 2 messages = Bit 0 can be modified 4 messages = Bits 1:0 can be modified 8 messages = Bits 2:0 can be modified 16 messages = Bits 3:0 can be modified</p> |

NOTE

Enabling MSI messaging in the XIO2213A has no effect.

4.43 Capability ID Register

This read-only register identifies the linked list item as the register for subsystem ID and subsystem vendor ID capabilities. The register returns 0Dh when read.

PCI register offset: 80h

Register type: Read-only

Default value: 0Dh

| BIT NUMBER | 7 | 6 | 5 | 4 | 3 | 2 | 1 | 0 |
|-------------|---|---|---|---|---|---|---|---|
| RESET STATE | 0 | 0 | 0 | 0 | 1 | 1 | 0 | 1 |

4.44 Next Item Pointer Register

The contents of this read-only register indicate the next item in the linked list of capabilities for the bridge. This register reads 90h pointing to the PCI Express capabilities registers.

PCI register offset: 81h

Register type: Read-only

Default value: 90h

| BIT NUMBER | 7 | 6 | 5 | 4 | 3 | 2 | 1 | 0 |
|-------------|---|---|---|---|---|---|---|---|
| RESET STATE | 1 | 0 | 0 | 1 | 0 | 0 | 0 | 0 |

4.45 Subsystem Vendor ID Register

This register, used for system and option card identification purposes, may be required for certain operating systems. This read-only register is initialized through the EEPROM and can be written through the subsystem alias register. This register shall only be reset by a Fundamental Reset (FRST#).

PCI register offset: 84h

Register type: Read-only

Default value: 0000h

| BIT NUMBER | 15 | 14 | 13 | 12 | 11 | 10 | 9 | 8 | 7 | 6 | 5 | 4 | 3 | 2 | 1 | 0 |
|-------------|----|----|----|----|----|----|---|---|---|---|---|---|---|---|---|---|
| RESET STATE | 0 | 0 | 0 | 0 | 0 | 0 | 0 | 0 | 0 | 0 | 0 | 0 | 0 | 0 | 0 | 0 |

4.46 Subsystem ID Register

This register, used for system and option card identification purposes, may be required for certain operating systems. This read-only register is initialized through the EEPROM and can be written through the subsystem alias register. This register shall only be reset by a Fundamental Reset (FRST#).

PCI register offset: 86h

Register type: Read-only

Default value: 0000h

| BIT NUMBER | 15 | 14 | 13 | 12 | 11 | 10 | 9 | 8 | 7 | 6 | 5 | 4 | 3 | 2 | 1 | 0 |
|-------------|----|----|----|----|----|----|---|---|---|---|---|---|---|---|---|---|
| RESET STATE | 0 | 0 | 0 | 0 | 0 | 0 | 0 | 0 | 0 | 0 | 0 | 0 | 0 | 0 | 0 | 0 |

4.47 PCI Express Capability ID Register

This read-only register identifies the linked list item as the register for PCI Express capabilities. The register returns 10h when read.

PCI register offset: 90h
 Register type: Read-only
 Default value: 10h

| | | | | | | | | |
|--------------------|----------|----------|----------|----------|----------|----------|----------|----------|
| BIT NUMBER | 7 | 6 | 5 | 4 | 3 | 2 | 1 | 0 |
| RESET STATE | 0 | 0 | 0 | 1 | 0 | 0 | 0 | 0 |

4.48 Next Item Pointer Register

The contents of this read-only register indicate the next item in the linked list of capabilities for the bridge. This register reads 00h indicating no additional capabilities are supported.

PCI register offset: 91h
 Register type: Read-only
 Default value: 00h

| | | | | | | | | |
|--------------------|----------|----------|----------|----------|----------|----------|----------|----------|
| BIT NUMBER | 7 | 6 | 5 | 4 | 3 | 2 | 1 | 0 |
| RESET STATE | 0 | 0 | 0 | 0 | 0 | 0 | 0 | 0 |

4.49 PCI Express Capabilities Register

This read-only register indicates the capabilities of the bridge related to PCI Express. See [Table 4-25](#) for a complete description of the register contents.

PCI register offset: 92h
 Register type: Read-only
 Default value: 0071h

| | | | | | | | | | | | | | | | | |
|--------------------|-----------|-----------|-----------|-----------|-----------|-----------|----------|----------|----------|----------|----------|----------|----------|----------|----------|----------|
| BIT NUMBER | 15 | 14 | 13 | 12 | 11 | 10 | 9 | 8 | 7 | 6 | 5 | 4 | 3 | 2 | 1 | 0 |
| RESET STATE | 0 | 0 | 0 | 0 | 0 | 0 | 0 | 0 | 0 | 1 | 1 | 1 | 0 | 0 | 0 | 1 |

Table 4-25. PCI Express Capabilities Register Description

| BIT | FIELD NAME | ACCESS | DESCRIPTION |
|------------|-------------------|---------------|---|
| 15:9 | RSVD | R | Reserved. Returns 000 0000b when read. |
| 8 | SLOT | R | Slot implemented. This bit is not valid for the bridge and is read-only 0b. |
| 7:4 | DEV_TYPE | R | Device/port type. This read-only field returns 0111b indicating that the device is a PCI Express-to-PCI bridge. |
| 3:0 | VERSION | R | Capability version. This field returns 1h indicating revision 1 of the PCI Express capability. |

4.50 Device Capabilities Register

The device capabilities register indicates the device specific capabilities of the bridge. See [Table 4-26](#) for a complete description of the register contents.

PCI register offset: 94h
Register type: Read-only
Default value: 0000 8002

| | | | | | | | | | | | | | | | | |
|--------------------|-----------|-----------|-----------|-----------|-----------|-----------|-----------|-----------|-----------|-----------|-----------|-----------|-----------|-----------|-----------|-----------|
| BIT NUMBER | 31 | 30 | 29 | 28 | 27 | 26 | 25 | 24 | 23 | 22 | 21 | 20 | 19 | 18 | 17 | 16 |
| RESET STATE | 0 | 0 | 0 | 0 | 0 | 0 | 0 | 0 | 0 | 0 | 0 | 0 | 0 | 0 | 0 | 0 |

| | | | | | | | | | | | | | | | | |
|--------------------|-----------|-----------|-----------|-----------|-----------|-----------|----------|----------|----------|----------|----------|----------|----------|----------|----------|----------|
| BIT NUMBER | 15 | 14 | 13 | 12 | 11 | 10 | 9 | 8 | 7 | 6 | 5 | 4 | 3 | 2 | 1 | 0 |
| RESET STATE | 1 | 0 | 0 | 0 | 0 | 0 | 0 | 0 | 0 | 0 | 0 | 0 | 0 | 0 | 1 | 0 |

Table 4-26. Device Capabilities Register Description

| BIT | FIELD NAME | ACCESS | DESCRIPTION |
|-------|------------|--------|--|
| 31:28 | RSVD | R | Reserved. Returns 0h when read. |
| 27:26 | CSPLS | RU | Captured slot power limit scale. The value in this field is programmed by the host by issuing a Set_Slot_Power_Limit message. When a Set_Slot_Power_Limit message is received, bits 9:8 are written to this field. The value in this field specifies the scale used for the slot power limit. 00 = 1.0x 01 = 0.1x 10 = 0.01x 11 = 0.001x1 |
| 25:18 | CSPLV | RU | Captured slot power limit value. The value in this field is programmed by the host by issuing a Set_Slot_Power_Limit message. When a Set_Slot_Power_Limit message is received, bits 7:0 are written to this field. The value in this field in combination with the slot power limit scale value (bits 27:26) specifies the upper limit of power supplied to the slot. The power limit is calculated by multiplying the value in this field by the value in the slot power limit scale field. |
| 17:16 | RSVD | R | Reserved. Return 000b when read. |
| 15 | RBER | R | Role Based Error Reporting. This bit is hardwired to 1 indicating that the XIO2213A supports Role Based Error Reporting |
| 14 | PIP | R | Power indicator present. This bit is hardwired to 0b indicating that a power indicator is not implemented. |
| 13 | AIP | R | Attention indicator present. This bit is hardwired to 0b indicating that an attention indicator is not implemented. |
| 12 | ABP | R | Attention button present. This bit is hardwired to 0b indicating that an attention button is not implemented. |
| 11:9 | EP_L1_LAT | RU | Endpoint L1 acceptable latency. This field indicates the maximum acceptable latency for a transition from L1 to L0 state. This field can be programmed by writing to the L1_LATENCY field (bits 15:13) in the general control register (offset D4h, see Section 4.66). The default value for this field is 000b which indicates a range less than 1μs. This field cannot be programmed to be less than the latency for the PHY to exit the L1 state. |
| 8:6 | EP_L0S_LAT | RU | Endpoint L0s acceptable latency. This field indicates the maximum acceptable latency for a transition from L0s to L0 state. This field can be programmed by writing to the L0s_LATENCY field (bits 18:16) in the general control register (offset D4h, see Section 4.66). The default value for this field is 000b which indicates a range less than 1μs. This field cannot be programmed to be less than the latency for the PHY to exit the L0s state. |
| 5 | ETFS | R | Extended tag field supported. This field indicates the size of the tag field not supported. |
| 4:3 | PFS | R | Phantom functions supported. This field is read-only 00b indicating that function numbers are not used for phantom functions. |
| 2:0 | MPSS | R | Maximum payload size supported. This field indicates the maximum payload size that the device can support for TLPs. This field is encoded as 010b indicating the maximum payload size for a TLP is 512 bytes. |

4.51 Device Control Register

The device control register controls PCI Express device specific meters. See [Table 4-27](#) for a complete description of the register contents.

PCI register offset: 98h

Register type: Read-only, Read/Write

Default value: 2800h

| BIT NUMBER | 15 | 14 | 13 | 12 | 11 | 10 | 9 | 8 | 7 | 6 | 5 | 4 | 3 | 2 | 1 | 0 |
|-------------|----|----|----|----|----|----|---|---|---|---|---|---|---|---|---|---|
| RESET STATE | 0 | 0 | 1 | 0 | 1 | 0 | 0 | 0 | 0 | 0 | 0 | 0 | 0 | 0 | 0 | 0 |

Table 4-27. Device Control Register Description

| BIT | FIELD NAME | ACCESS | DESCRIPTION |
|-------|--------------|--------|---|
| 15 | CFG_RTRY_ENB | RW | Configuration retry status enable. When this read/write bit is set to 1b, the bridge returns a completion with completion retry status on PCI Express if a configuration transaction forwarded to the secondary interface did not complete within the implementation specific time-out period. When this bit is set to 0b, the bridge does not generate completions with completion retry status on behalf of configuration transactions. The default value of this bit is 0b. |
| 14:12 | MRRS | RW | Maximum read request size. This field is programmed by host software to set the maximum size of a read request that the bridge can generate. The bridge uses this field in conjunction with the cache line size register (offset 0Ch, see Section 7.6) to determine how much data to fetch on a read request. This field is encoded as: 000 = 128B 001 = 256B 010 = 512B (default) 011 = 1024B 100 = 2048B 101 = 4096B 110 = Reserved 111 = Reserved |
| 11 | ENS | RW | Enable no snoop. Controls the setting of the no snoop flag within the TLP header for upstream memory transactions mapped to any traffic class mapped to a virtual channel (VC) other than VC0 through the upstream decode windows. 0 = No snoop field is 0b 1 = No snoop field is 1b (default) |
| 10 | APPE | RW | Auxiliary power PM enable. This bit has no effect in the bridge. 0 = AUX power is disabled (default) 1 = AUX power is enabled |
| 9 | PFE | R | Phantom function enable. Since the bridge does not support phantom functions, this bit is read-only 0b. |
| 8 | ETFE | R | Extended tag field enable. Since the bridge does not support extended tags, this bit is read-only 0b. |
| 7:5 | MPS | RW | Maximum payload size. This field is programmed by host software to set the maximum size of posted writes or read completions that the bridge can initiate. This field is encoded as: 000 = 128B (default) 001 = 256B 010 = 512B 011 = 1024B 100 = 2048B 101 = 4096B 110 = Reserved 111 = Reserved |
| 4 | ERO | R | Enable relaxed ordering. Since the bridge does not support relaxed ordering, this bit is read-only 0b. |
| 3 | URRE | RW | Unsupported request reporting enable. If this bit is set, then the bridge sends an ERR_NONFATAL message to the root complex when an unsupported request is received. 0 = Do not report unsupported requests to the root complex (default) 1 = Report unsupported requests to the root complex |

Table 4-27. Device Control Register Description (continued)

| BIT | FIELD NAME | ACCESS | DESCRIPTION |
|-----|------------|--------|---|
| 2 | FERE | RW | Fatal error reporting enable. If this bit is set, then the bridge is enabled to send ERR_FATAL messages to the root complex when a system error event occurs. 0 = Do not report fatal errors to the root complex (default) 1 = Report fatal errors to the root complexd |
| 1 | NFERE | RW | Nonfatal error reporting enable. If this bit is set, then the bridge is enabled to send ERR_NONFATAL messages to the root complex when a system error event occurs. 0 = Do not report nonfatal errors to the root complex (default) 1 = Report nonfatal errors to the root complexd |
| 0 | CERE | RW | Correctable error reporting enable. If this bit is set, then the bridge is enabled to send ERR_COR messages to the root complex when a system error event occurs. 0 = Do not report correctable errors to the root complex (default) 1 = Report correctable errors to the root complex. |

4.52 Device Status Register

The device status register provides PCI Express device specific information to the system. See [Table 4-28](#) for a complete description of the register contents.

PCI register offset: 9Ah

Register type: Read-only

Default value: 0000h

| BIT NUMBER | 15 | 14 | 13 | 12 | 11 | 10 | 9 | 8 | 7 | 6 | 5 | 4 | 3 | 2 | 1 | 0 |
|-------------|----|----|----|----|----|----|---|---|---|---|---|---|---|---|---|---|
| RESET STATE | 0 | 0 | 0 | 0 | 0 | 0 | 0 | 0 | 0 | 0 | 0 | 0 | 0 | 0 | 0 | 0 |

Table 4-28. Device Status Register Description

| BIT | FIELD NAME | ACCESS | DESCRIPTION |
|------|------------|--------|---|
| 15:6 | RSVD | R | Reserved. Returns 00 0000 0000b when read. |
| 5 | PEND | RU | Transaction pending. This bit is set when the bridge has issued a nonposted transaction that has not been completed. |
| 4 | APD | RU | AUX power detected. This bit indicates that AUX power is present. 0 = No AUX power detected 1 = AUX power detectedd |
| 3 | URD | RCU | Unsupported request detected. This bit is set by the bridge when an unsupported request is received. |
| 2 | FED | RCU | Fatal error detected. This bit is set by the bridge when a fatal error is detected. |
| 1 | NFED | RCU | Nonfatal error detected. This bit is set by the bridge when a nonfatal error is detected. |
| 0 | CED | RCU | Correctable error detected. This bit is set by the bridge when a correctable error is detected. |

4.53 Link Capabilities Register

The link capabilities register indicates the link specific capabilities of the bridge. See [Table 4-29](#) for a complete description of the register contents.

PCI register offset: 9Ch
 Register type: Read-only
 Default value: 0006 XC11h

| | | | | | | | | | | | | | | | | |
|--------------------|-----------|-----------|-----------|-----------|-----------|-----------|-----------|-----------|-----------|-----------|-----------|-----------|-----------|-----------|-----------|-----------|
| BIT NUMBER | 31 | 30 | 29 | 28 | 27 | 26 | 25 | 24 | 23 | 22 | 21 | 20 | 19 | 18 | 17 | 16 |
| RESET STATE | 0 | 0 | 0 | 0 | 0 | 0 | 0 | 0 | 0 | 0 | 0 | 0 | 0 | 1 | 1 | 0 |

| | | | | | | | | | | | | | | | | |
|--------------------|-----------|-----------|-----------|-----------|-----------|-----------|----------|----------|----------|----------|----------|----------|----------|----------|----------|----------|
| BIT NUMBER | 15 | 14 | 13 | 12 | 11 | 10 | 9 | 8 | 7 | 6 | 5 | 4 | 3 | 2 | 1 | 0 |
| RESET STATE | 0 | x | x | x | 1 | 1 | 0 | 0 | 0 | 0 | 0 | 1 | 0 | 0 | 0 | 1 |

Table 4-29. Link Capabilities Register Description

| BIT | FIELD NAME | ACCESS | DESCRIPTION |
|-------|-------------|--------|--|
| 31:24 | PORT_NUM | R | Port number. This field indicates port number for the PCI Express link. This field is read-only 00h indicating that the link is associated with port 0. |
| 23:19 | RSVD | R | Reserved. Return 00 0000b when read. |
| 18 | CLK_PM | R | Clock Power Management. This bit is hardwired to 1 to indicate that XIO2213A supports Clock Power Management through CLKREQ protocol. |
| 17:15 | L1_LATENCY | R | L1 exit latency. This field indicates the time that it takes to transition from the L1 state to the L0 state. Bit 6 (CCC) in the link control register (offset A0h, see Section 4.54) equals 1b for a common clock and equals 0b for an asynchronous clock. For a common reference clock, the value of this field is determined by bits 20:18 (L1_EXIT_LAT_ASYNC) of the control and diagnostic register 1 (offset C4h, see Section 4.63). For an asynchronous reference clock, the value of this field is determined by bits 17:15 (L1_EXIT_LAT_COMMON) of the control and diagnostic register 1 (offset C4h, see Section 4.63). |
| 14:12 | L0S_LATENCY | R | L0s exit latency. This field indicates the time that it takes to transition from the L0s state to the L0 state. Bit 6 (CCC) in the link control register (offset A0h, see Section 4.54) equals 1b for a common clock and equals 0b for an asynchronous clock. For a common reference clock, the value of 011b indicates that the L1 exit latency falls between 256 ns to less than 512 ns. For an asynchronous reference clock, the value of 100b indicates that the L1 exit latency falls between 512 ns to less than 1 μs. |
| 11:10 | ASLPMS | R | Active state link PM support. This field indicates the level of active state power management that the bridge supports. The value 11b indicates support for both L0s and L1 through active state power management. |
| 9:4 | MLW | R | Maximum link width. This field is encoded 00 0001b to indicate that the bridge only supports a 1x PCI Express link. |
| 3:0 | MLS | R | Maximum link speed. This field is encoded 1h to indicate that the bridge supports a maximum link speed of 2.5 Gb/s. |

4.54 Link Control Register

The link control register controls link specific behavior. See [Table 4-30](#) for a complete description of the register contents.

PCI register offset: A0h
Register type: Read-only, Read/Write
Default value: 0000h

| BIT NUMBER | 15 | 14 | 13 | 12 | 11 | 10 | 9 | 8 | 7 | 6 | 5 | 4 | 3 | 2 | 1 | 0 |
|-------------|----|----|----|----|----|----|---|---|---|---|---|---|---|---|---|---|
| RESET STATE | 0 | 0 | 0 | 0 | 0 | 0 | 0 | 0 | 0 | 0 | 0 | 0 | 0 | 0 | 0 | 0 |

Table 4-30. Link Control Register Description

| BIT | FIELD NAME | ACCESS | DESCRIPTION |
|------|------------|--------|--|
| 15:9 | RSVD | RW | Reserved. Returns 00h when read. |
| 8 | CPM_EN | RW | Clock Power Management Enable. This bit is used to enable XIO2213A to use $\overline{\text{CLKREQ}}$ for clock power management 0 = Clock Power Management is disabled and XIO2213A shall hold the $\overline{\text{CLKREQ}}$ signal low 1 = Clock Power Management is enabled and XIO2213A is permitted to use the $\overline{\text{CLKREQ}}$ signal to allow the REFCLK input to be stopped |
| 7 | ES | RW | Extended synch. This bit forces the bridge to extend the transmission of FTS ordered sets and an extra TS2 when exiting from L1 prior to entering to L0. 0 = Normal synch (default) 1 = Extended synch |
| 6 | CCC | RW | Common clock configuration. When this bit is set, it indicates that the bridge and the device at the opposite end of the link are operating with a common clock source. A value of 0b indicates that the bridge and the device at the opposite end of the link are operating with separate reference clock sources. The bridge uses this common clock configuration information to report the correct L0s and L1 exit latencies. 0 = Reference clock is asynchronous (default) 1 = Reference clock is common |
| 5 | RL | R | Retrain link. This bit has no function and is read-only 0b. |
| 4 | LD | R | Link disable. This bit has no function and is read-only 0b. |
| 3 | RCB | RW | Read completion boundary. This bit is an indication of the RCB of the root complex. The state of this bit has no affect on the bridge, since the RCB of the bridge is fixed at 128 bytes. 0 = 64 bytes (default) 1 = 128 bytes |
| 2 | RSVD | R | Reserved. Returns 0b when read. |
| 1:0 | ASLPMC | RW | Active state link PM control. This field enables and disables the active state PM. 00 = Active state PM disabled (default) 01 = L0s entry enabled 10 = L1 entry enabled 11 = L0s and L1 entry enabled |

4.55 Link Status Register

The link status register indicates the current state of the PCI Express link. See [Table 4-31](#) for a complete description of the register contents.

PCI register offset: A2h

Register type: Read-only

Default value: X011h

| BIT NUMBER | 15 | 14 | 13 | 12 | 11 | 10 | 9 | 8 | 7 | 6 | 5 | 4 | 3 | 2 | 1 | 0 |
|-------------|----|----|----|----|----|----|---|---|---|---|---|---|---|---|---|---|
| RESET STATE | 0 | 0 | 0 | x | 0 | 0 | 0 | 0 | 0 | 0 | 0 | 1 | 0 | 0 | 0 | 1 |

Table 4-31. Link Status Register Description

| BIT | FIELD NAME | ACCESS | DESCRIPTION |
|-------|------------|--------|--|
| 15:13 | RSVD | R | Reserved. Returns 000b when read. |
| 12 | SCC | R | Slot clock configuration. This bit indicates that the bridge uses the same physical reference clock that the platform provides on the connector. If the bridge uses an independent clock irrespective of the presence of a reference on the connector, then this bit must be cleared. 0 = Independent 125-MHz reference clock is used 1 = Common 100-MHz reference clock is used |
| 11 | LT | R | Link training. This bit has no function and is read-only 0b. |
| 10 | TE | R | Retrain link. This bit has no function and is read-only 0b. |
| 9:4 | NLW | R | Negotiated link width. This field is read-only 00 0001b indicating the lane width is 1x. |
| 3:0 | LS | R | Link speed. This field is read-only 1h indicating the link speed is 2.5 Gb/s. |

4.56 Serial-Bus Data Register

The serial-bus data register reads and writes data on the serial-bus interface. Write data is loaded into this register prior to writing the serial-bus slave address register (offset B2h, see [Section 4.58](#)) that initiates the bus cycle. When reading data from the serial bus, this register contains the data read after bit 5 (REQBUSY) of the serial-bus control and status register (offset B3h, see [Section 4.59](#)) is cleared. This register shall only be reset by a Fundamental Reset ($\overline{\text{FRST}}$).

PCI register offset: B0h

Register type: Read/Write

Default value: 00h

| BIT NUMBER | 7 | 6 | 5 | 4 | 3 | 2 | 1 | 0 |
|-------------|---|---|---|---|---|---|---|---|
| RESET STATE | 0 | 0 | 0 | 0 | 0 | 0 | 0 | 0 |

4.57 Serial-Bus Word Address Register

The value written to the serial-bus word address register represents the word address of the byte being read from or written to the serial-bus device. The word address is loaded into this register prior to writing the serial-bus slave address register (offset B2h, see [Section 4.58](#)) that initiates the bus cycle. This register shall only be reset by a Fundamental Reset ($\overline{\text{FRST}}$).

PCI register offset: B1h

Register type: Read/Write

Default value: 00h

| BIT NUMBER | 7 | 6 | 5 | 4 | 3 | 2 | 1 | 0 |
|-------------|---|---|---|---|---|---|---|---|
| RESET STATE | 0 | 0 | 0 | 0 | 0 | 0 | 0 | 0 |

4.58 Serial-Bus Slave Address Register

The serial-bus slave address register indicates the slave address of the device being targeted by the serial-bus cycle. This register also indicates if the cycle is a read or a write cycle. Writing to this register initiates the cycle on the serial interface. See [Table 4-32](#) for a complete description of the register contents.

PCI register offset: B2h
Register type: Read/Write
Default value: 00h

| BIT NUMBER | 7 | 6 | 5 | 4 | 3 | 2 | 1 | 0 |
|-------------|---|---|---|---|---|---|---|---|
| RESET STATE | 0 | 0 | 0 | 0 | 0 | 0 | 0 | 0 |

Table 4-32. Serial-Bus Slave Address Register Descriptions

| BIT | FIELD NAME | ACCESS | DESCRIPTION |
|--------------------|------------|--------|--|
| 7:1 ⁽¹⁾ | SLAVE_ADDR | RW | Serial-bus slave address. This 7-bit field is the slave address for a serial-bus read or write transaction. The default value for this field is 000 0000b. |
| 0 ⁽¹⁾ | RW_CMD | RW | Read/write command. This bit determines if the serial-bus cycle is a read or a write cycle. 0 = A single byte write is requested (default). 1 = A single byte read is requested. |

(1) This register shall only be reset by a Fundamental Reset ($\overline{\text{FRST}}$).

4.59 Serial-Bus Control and Status Register

The serial-bus control and status register controls the behavior of the serial-bus interface. This register also provides status information about the state of the serial bus. See [Table 4-33](#) for a complete description of the register contents.

PCI register offset: B3h
Register type: Read-only, Read/Write, Read/Clear
Default value: 00h

| BIT NUMBER | 7 | 6 | 5 | 4 | 3 | 2 | 1 | 0 |
|-------------|---|---|---|---|---|---|---|---|
| RESET STATE | 0 | 0 | 0 | 0 | 0 | 0 | 0 | 0 |

Table 4-33. Serial-Bus Control and Status Register Description

| BIT | FIELD NAME | ACCESS | DESCRIPTION |
|------------------|------------|--------|---|
| 7 ⁽¹⁾ | PROT_SEL | RW | Protocol select. This bit selects the serial-bus address mode used. 0 = Slave address and word address are sent on the serial-bus (default) 1 = Only the slave address is sent on the serial-bus |
| 6 | RSVD | R | Reserved. Returns 0b when read. |
| 5 ⁽¹⁾ | REQBUSY | RU | Requested serial-bus access busy. This bit is set when a software-initiated serial-bus cycle is in progress. 0 = No serial-bus cycle 1 = Serial-bus cycle in progress |
| 4 ⁽¹⁾ | ROMBUSY | RU | Serial EEPROM access busy. This bit is set when the serial EEPROM circuitry in the bridge is downloading register defaults from a serial EEPROM. 0 = No EEPROM activity 1 = EEPROM download in progress |

(1) This register shall only be reset by a Fundamental Reset ($\overline{\text{FRST}}$).

Table 4-33. Serial-Bus Control and Status Register Description (continued)

| BIT | FIELD NAME | ACCESS | DESCRIPTION |
|------------------|------------|--------|---|
| 3 ⁽¹⁾ | SBDETECT | RWU | Serial EEPROM access busy. This bit is set when the serial EEPROM circuitry in the bridge is downloading register defaults from a serial EEPROM. Note: A serial EEPROM is only detected once following $\overline{\text{PERST}}$. 0 = No EEPROM present, EEPROM load process does not happen. GPIO4//SCL and GPIO5//SDA terminals are configured as GPIO signals. 1 = EEPROM present, EEPROM load process takes place. GPIO4//SCL and GPIO5//SDA terminals are configured as serial-bus signals. |
| 2 ⁽¹⁾ | SBTEST | RW | Serial-bus test. This bit is used for internal test purposes. This bit controls the clock source for the serial interface clock. 0 = Serial-bus clock at normal operating frequency ~ 60 kHz (default) 1 = Serial-bus clock frequency increased for test purposes ~ 4 MHz |
| 1 ⁽¹⁾ | SB_ERR | RCU | Serial-bus error. This bit is set when an error occurs during a software-initiated serial-bus cycle. 0 = No error 1 = Serial-bus error |
| 0 ⁽¹⁾ | ROM_ERR | RCU | Serial EEPROM load error. This bit is set when an error occurs while downloading registers from serial EEPROM. 0 = No error 1 = EEPROM load error |

4.60 GPIO Control Register

This register controls the direction of the eight GPIO terminals. This register has no effect on the behavior of GPIO terminals that are enabled to perform secondary functions. The secondary functions share GPIO4 (SCL) and GPIO5 (SDA). See [Table 4-34](#) for a complete description of the register contents.

PCI register offset: B4h
Register type: Read-only, Read/Write
Default value: 0000h

| BIT NUMBER | 15 | 14 | 13 | 12 | 11 | 10 | 9 | 8 | 7 | 6 | 5 | 4 | 3 | 2 | 1 | 0 |
|-------------|----|----|----|----|----|----|---|---|---|---|---|---|---|---|---|---|
| RESET STATE | 0 | 0 | 0 | 0 | 0 | 0 | 0 | 0 | 0 | 0 | 0 | 0 | 0 | 0 | 0 | 0 |

Table 4-34. GPIO Control Register Description

| BIT | FIELD NAME | ACCESS | DESCRIPTION |
|------------------|------------|--------|--|
| 15:8 | RSVD | R | Reserved. Return 00h when read. |
| 7 ⁽¹⁾ | GPIO7_DIR | RW | GPIO 7 data direction. This bit selects whether GPIO7 is in input or output mode. 0 = Input (default) 1 = Output |
| 6 ⁽¹⁾ | GPIO6_DIR | RW | GPIO 6 data direction. This bit selects whether GPIO6 is in input or output mode. 0 = Input (default) 1 = Output |
| 5 ⁽¹⁾ | GPIO5_DIR | RW | GPIO 5 data direction. This bit selects whether GPIO5 is in input or output mode. 0 = Input (default) 1 = Output |
| 4 ⁽¹⁾ | GPIO4_DIR | RW | GPIO 4 data direction. This bit selects whether GPIO4 is in input or output mode. 0 = Input (default) 1 = Output |
| 3 ⁽¹⁾ | GPIO3_DIR | RW | GPIO 3 data direction. This bit selects whether GPIO3 is in input or output mode. 0 = Input (default) 1 = Output |
| 2 ⁽¹⁾ | GPIO2_DIR | RW | GPIO 2 data direction. This bit selects whether GPIO2 is in input or output mode. 0 = Input (default) 1 = Output |
| 1 ⁽¹⁾ | GPIO1_DIR | RW | GPIO 1 data direction. This bit selects whether GPIO1 is in input or output mode. 0 = Input (default) 1 = Output |
| 0 ⁽¹⁾ | GPIO0_DIR | RW | GPIO 0 data direction. This bit selects whether GPIO0 is in input or output mode. 0 = Input (default) 1 = Output |

(1) This register shall only be reset by a Fundamental Reset ($\overline{\text{FRST}}$).

4.61 GPIO Data Register

This register reads the state of the input mode GPIO terminals and changes the state of the output mode GPIO terminals. Writing to a bit that is in input mode or is enabled for a secondary function is ignored. The secondary functions share GPIO4 (SCL) and GPIO5 (SDA). The default value at power up depends on the state of the GPIO terminals as they default to general-purpose inputs. See [Table 4-35](#) for a complete description of the register contents.

PCI register offset: B6h
 Register type: Read-only, Read/Write
 Default value: 00XXh

| BIT NUMBER | 15 | 14 | 13 | 12 | 11 | 10 | 9 | 8 | 7 | 6 | 5 | 4 | 3 | 2 | 1 | 0 |
|-------------|----|----|----|----|----|----|---|---|---|---|---|---|---|---|---|---|
| RESET STATE | 0 | 0 | 0 | 0 | 0 | 0 | 0 | 0 | x | x | x | x | x | x | x | x |

Table 4-35. GPIO Data Register Description

| BIT | FIELD NAME | ACCESS | DESCRIPTION |
|------------------|------------|--------|--|
| 15:8 | RSVD | R | Reserved |
| 7 ⁽¹⁾ | GPIO7_DATA | RW | GPIO 7 data. This bit reads the state of GPIO7 when in input mode or changes the state of GPIO7 when in output mode. |
| 6 ⁽¹⁾ | GPIO6_DATA | RW | GPIO 6 data. This bit reads the state of GPIO6 when in input mode or changes the state of GPIO6 when in output mode. |
| 5 ⁽¹⁾ | GPIO5_DATA | RW | GPIO 5 data. This bit reads the state of GPIO5 when in input mode or changes the state of GPIO5 when in output mode. |
| 4 ⁽¹⁾ | GPIO4_DATA | RW | GPIO 4 data. This bit reads the state of GPIO4 when in input mode or changes the state of GPIO4 when in output mode. |
| 3 ⁽¹⁾ | GPIO3_DATA | RW | GPIO 3 data. This bit reads the state of GPIO3 when in input mode or changes the state of GPIO3 when in output mode. |
| 2 ⁽¹⁾ | GPIO2_DATA | RW | GPIO 2 data. This bit reads the state of GPIO2 when in input mode or changes the state of GPIO2 when in output mode. |
| 1 ⁽¹⁾ | GPIO1_DATA | RW | GPIO 1 data. This bit reads the state of GPIO1 when in input mode or changes the state of GPIO1 when in output mode. |
| 0 ⁽¹⁾ | GPIO0_DATA | RW | GPIO 0 data. This bit reads the state of GPIO0 when in input mode or changes the state of GPIO0 when in output mode. |

(1) This register shall only be reset by a Fundamental Reset ($\overline{\text{FRST}}$).

4.62 Control and Diagnostic Register 0

The contents of this register are used for monitoring status and controlling behavior of the bridge. See [Table 4-36](#) for a complete description of the register contents. It is recommended that all values within this register be left at the default value. Improperly programming fields in this register may cause interoperability or other problems.

PCI register offset: C0h
Register type: Read/Write
Default value: 0000 0000h

| | | | | | | | | | | | | | | | | |
|--------------------|-----------|-----------|-----------|-----------|-----------|-----------|-----------|-----------|-----------|-----------|-----------|-----------|-----------|-----------|-----------|-----------|
| BIT NUMBER | 31 | 30 | 29 | 28 | 27 | 26 | 25 | 24 | 23 | 22 | 21 | 20 | 19 | 18 | 17 | 16 |
| RESET STATE | 0 | 0 | 0 | 0 | 0 | 0 | 0 | 0 | 0 | 0 | 0 | 0 | 0 | 0 | 0 | 0 |

| | | | | | | | | | | | | | | | | |
|--------------------|-----------|-----------|-----------|-----------|-----------|-----------|----------|----------|----------|----------|----------|----------|----------|----------|----------|----------|
| BIT NUMBER | 15 | 14 | 13 | 12 | 11 | 10 | 9 | 8 | 7 | 6 | 5 | 4 | 3 | 2 | 1 | 0 |
| RESET STATE | 0 | 0 | 0 | 0 | 0 | 0 | 0 | 0 | 0 | 0 | 0 | 0 | 0 | 0 | 0 | 0 |

Table 4-36. Control and Diagnostic Register 0 Description

| BIT | FIELD NAME | ACCESS | DESCRIPTION |
|----------------------|---------------------|---------------|---|
| 31:24 ⁽¹⁾ | PRI_BUS_NUM | R | This field contains the captured primary bus number. |
| 23:19 ⁽¹⁾ | PRI_DEVICE_NUM | R | This field contains the captured primary device number. |
| 18 | ALT_ERROR_REP | RW | Alternate Error Reporting. This bit controls the method that the XIO2213A uses for error reporting. 0 = Advisory Non-Fatal Error reporting supported (default) 1 = Advisory Non-Fatal Error reporting not supported |
| 17 | DIS_BRIDGE_PME | RW | Disable Bridge PME# input 0 = The PME# input signal to the bridge is enabled and connected to the PME# signal from the 1394 OHCI function (default) 1 = The PME# input signal to the bridge is disabled |
| 16 | DIS_OHCI_PME | RW | Disable OHCI_PME# pin 0 = OHCI_PME# pin is enabled and connected to the PME# signal from the 1394 OHCI function (default) 1 = OHCI_PME# pin is disabled |
| 15:14 ⁽¹⁾ | FIFO_SIZE | RW | FIFO size. This field contains the maximum size (in DW) of the FIFO. |
| 13:12 | RSVD | R | Reserved. Returns 00b when read. |
| 11 | ALLOW_CFG_ANY_FN | RW | Allow Config Access to any Functin. When this bit is set, the bridge shall respond to config accesses to any function number. |
| 10 | RETURN_PW_CREDITS | RW | Return PW Packet Credits. When this bit is set, the bridge shall return all the PW packet credits. |
| 9 | RSVD | R | Reserved. Returns 0b when read. |
| 8 | RETURN_CPL_CREDITS | RW | Return Completion Credits. When this bit is set, the bridge shall return all completion credits immediately. |
| 7 | EN_CACHE_LINE_CHECK | RW | Enable Cache Line Check. 0 = The bridge shall use side band signals to determine the transaction size (default) 1 = The bridge shall use the Cache Line Size Register to determine the transaction size |

(1) This register shall only be reset by a Fundamental Reset ($\overline{\text{FRST}}$).

Table 4-36. Control and Diagnostic Register 0 Description (continued)

| BIT | FIELD NAME | ACCESS | DESCRIPTION |
|--------------------|--------------------|--------|--|
| 6 ⁽¹⁾ | PREFETCH_4X | RW | Prefetch 4X enable. 0 = The bridge will prefetch up to 2 cache lines, as defined in the cache line size register (offset 0Ch, see Section 7.6) for upstream memory read multiple (MRM) transactions (default) 1 = The bridge device will prefetch up to 4 cache lines, as defined in the cache line size register (offset 0Ch, see Section 7.6) for upstream memory read multiple (MRM) transactions. Note1: When this bit is set and the FORCE_MRM bit in the General Control Register is set, then both upstream memory read multiple transactions and upstream memory transactions will prefetch up to 4 cache lines. Note2: When the READ_PREFETCH_DIS bit in the General Control Register is set, this bit shall have no effect and only one DWORD shall be fetched on a burst read. This bit shall only affect the XIO2213A design when the EN_CACHE_LINE_CHECK bit is set. |
| 5:4 ⁽¹⁾ | UP_REQ_BUF_VALUE | RW | PCI upstream req-res buffer threshold value. The value in this field controls the buffer space that must be available for the device to accept a PCI bus transaction. If the cache line size is not valid, then the device will use 8 DW for calculating the threshold value. 00 = 1 Cacheline + 4 DW (default) 01 = 1 Cacheline + 8 DW 10 = 1 Cacheline + 12 DW 11 = 2 Cachelines + 4 DW |
| 3 ⁽¹⁾ | UP_REQ_BUF_CTRL | RW | PCI upstream req-res buffer threshold control. This bit enables the PCI upstream req-res buffer threshold control mode of the bridge. 0 = PCI upstream req-res buffer threshold control mode disabled (default) 1 = PCI upstream req-res buffer threshold control mode enabled |
| 2 ⁽¹⁾ | CFG_ACCESS_MEM_REG | RW | Configuration access to memory-mapped registers. When this bit is set, the bridge allows configuration access to memory-mapped configuration registers. |
| 1 ⁽¹⁾ | RSVD | RW | Reserved. Bit 1 defaults to 0b. If this register is programmed via EEPROM or another mechanism, the value written into this field must be 0b. |
| 0 | RSVD | R | Reserved. Returns 0b when read. |

4.63 Control and Diagnostic Register 1

The contents of this register are used for monitoring status and controlling behavior of the bridge. See [Table 4-37](#) for a complete description of the register contents. It is recommended that all values within this register be left at the default value. Improperly programming fields in this register may cause interoperability or other problems.

PCI register offset: C4h
 Register type: Read/Write
 Default value: 0012 0108h

| | | | | | | | | | | | | | | | | |
|--------------------|----|----|----|----|----|----|----|----|----|----|----|----|----|----|----|----|
| BIT NUMBER | 31 | 30 | 29 | 28 | 27 | 26 | 25 | 24 | 23 | 22 | 21 | 20 | 19 | 18 | 17 | 16 |
| RESET STATE | 0 | 0 | 0 | 0 | 0 | 0 | 0 | 0 | 0 | 0 | 0 | 1 | 0 | 0 | 1 | 0 |
| BIT NUMBER | 15 | 14 | 13 | 12 | 11 | 10 | 9 | 8 | 7 | 6 | 5 | 4 | 3 | 2 | 1 | 0 |
| RESET STATE | 0 | 0 | 0 | 0 | 0 | 0 | 0 | 1 | 0 | 0 | 0 | 0 | 1 | 0 | 0 | 0 |

Table 4-37. Control and Diagnostic Register 1 Description

| BIT | FIELD NAME | ACCESS | DESCRIPTION |
|----------------------|-------------------|--------|--|
| 32:21 | RSVD | R | Reserved. Returns 000h when read. |
| 20:18 ⁽¹⁾ | L1_EXIT_LAT_ASYNC | RW | L1 exit latency for asynchronous clock. When bit 6 (CCC) of the link control register (offset A0h, see Section 4.54) is set, the value in this field is mirrored in bits 17:15 (L1_LATENCY) field in the link capabilities register (offset 9Ch, see Section 4.53). This field defaults to 100b. |

(1) This register shall only be reset by a Fundamental Reset ($\overline{\text{FRST}}$).

Table 4-37. Control and Diagnostic Register 1 Description (continued)

| BIT | FIELD NAME | ACCESS | DESCRIPTION |
|----------------------|--------------------|--------|--|
| 17:15 ⁽¹⁾ | L1_EXIT_LAT_COMMON | RW | L1 exit latency for common clock. When bit 6 (CCC) of the link control register (offset A0h, see Section 4.54) is clear, the value in this field is mirrored in bits 17:15 (L1_LATENCY) field in the link capabilities register (offset 9Ch, see Section 4.53). This field defaults to 100b. |
| 14:11 ⁽¹⁾ | RSVD | RW | Reserved. Bits 14:11 default to 0000b. If this register is programmed via EEPROM or another mechanism, the value written into this field must be 0000b. |
| 10 ⁽¹⁾ | SBUS_RESET_MASK | RW | Secondary bus reset bit mask. When this bit is set, the bridge masks the reset caused by bit 6 (SRST) of the bridge control register (offset 3Eh, see Section 4.30). This bit defaults to 0b. |
| 9:6 ⁽¹⁾ | L1ASPM_TIMER | RW | L1ASPM entry timer. This field specifies the value (in 512-ns ticks) of the L1ASPM entry timer. This field defaults to 0100b. |
| 5:2 ⁽¹⁾ | L0s_TIMER | RW | L0s entry timer. This field specifies the value (in 62.5-MHz clock ticks) of the L0s entry timer. This field defaults to 0010b. |
| 1:0 ⁽¹⁾ | RSVD | RW | Reserved. Bits 1:0 default to 00b. If this register is programmed via EEPROM or another mechanism, then the value written into this field must be 00b. |

4.64 PHY Control and Diagnostic Register 2

The contents of this register are used for monitoring status and controlling behavior of the physical layer macro for diagnostic purposes. See [Table 4-38](#) for a complete description of the register contents. It is recommended that all values within this register be left at the default value. Improperly programming fields in this register may cause interoperability or other problems.

PCI register offset: C8h
 Register type: Read/Write
 Default value: 3214 2000h

| | | | | | | | | | | | | | | | | |
|--------------------|-----------|-----------|-----------|-----------|-----------|-----------|-----------|-----------|-----------|-----------|-----------|-----------|-----------|-----------|-----------|-----------|
| BIT NUMBER | 31 | 30 | 29 | 28 | 27 | 26 | 25 | 24 | 23 | 22 | 21 | 20 | 19 | 18 | 17 | 16 |
| RESET STATE | 0 | 0 | 1 | 1 | 0 | 0 | 1 | 0 | 0 | 0 | 0 | 1 | 0 | 1 | 0 | 0 |

| | | | | | | | | | | | | | | | | |
|--------------------|-----------|-----------|-----------|-----------|-----------|-----------|----------|----------|----------|----------|----------|----------|----------|----------|----------|----------|
| BIT NUMBER | 15 | 14 | 13 | 12 | 11 | 10 | 9 | 8 | 7 | 6 | 5 | 4 | 3 | 2 | 1 | 0 |
| RESET STATE | 0 | 0 | 1 | 0 | 0 | 0 | 0 | 0 | 0 | 0 | 0 | 0 | 0 | 0 | 0 | 0 |

Table 4-38. Control and Diagnostic Register 2 Description

| BIT | FIELD NAME | ACCESS | DESCRIPTION |
|----------------------|-----------------------|--------|---|
| 31:24 ⁽¹⁾ | N_FTS_ ASYNC_CLK | RW | N_FTS for asynchronous clock. When bit 6 (CCC) of the link control register (offset A0h, see Section 4.54) is clear, the value in this field is the number of FTS that are sent on a transition from L0s to L0. This field shall default to 32h. |
| 23:16 ⁽¹⁾ | N_FTS_ COMMON_CLK | RW | N_FTS for common clock. When bit 6 (CCC) of the link control register (offset A0h, see Section 4.54) is set, the value in this field is the number of FTS that are sent on a transition from L0s to L0. This field defaults to 14h. |
| 15:13 | PHY_REV | R | PHY revision number |
| 12:8 ⁽¹⁾ | LINK_NUM | RW | Link number |
| 7 | EN_L2_PWR_SAVE | RW | Enable L2 Power Savings 0= Power savings not enabled when in L2 1= Power savings enabled when in L2. |
| 6 | BAR1_EN | RW | BAR 1 Enable. 0 = BAR at offset 14h is disabled (default) 1 = BAR at offset 14h is enabled |
| 5 | BAR0_EN | RW | BAR01 Enable. 0 = BAR at offset 10h is disabled (default) 1 = BAR at offset 10h is enabled |
| 4 | REQ_RECOVERY | RW | REQ_RECOVERY to LTSSM |
| 3 | REQ_RECONFIG | RW | REQ_RECONFIGURE to LTSSM |
| 2 | REQ_HOT_RESET | RW | REQ_HOT_RESET to LTSSM |
| 1 | REQ_DISABLE_SCRAMBLER | RW | REQ_DISABLE_SCRAMBLER to LTSSM |
| 0 | REQ_LOOPBACK | RW | REQ_LOOPBACK to LTSSM |

(1) This register shall only be reset by a Fundamental Reset ($\overline{\text{FRST}}$).

4.65 Subsystem Access Register

The contents of this read/write register are aliased to the subsystem vendor ID and subsystem ID registers at PCI offsets 84h and 86h. See [Table 4-39](#) for a complete description of the register contents.

PCI register offset: D0h
 Register type: Read/Write
 Default value: 0000 0000h

| | | | | | | | | | | | | | | | | |
|--------------------|-----------|-----------|-----------|-----------|-----------|-----------|-----------|-----------|-----------|-----------|-----------|-----------|-----------|-----------|-----------|-----------|
| BIT NUMBER | 31 | 30 | 29 | 28 | 27 | 26 | 25 | 24 | 23 | 22 | 21 | 20 | 19 | 18 | 17 | 16 |
| RESET STATE | 0 | 0 | 0 | 0 | 0 | 0 | 0 | 0 | 0 | 0 | 0 | 0 | 0 | 0 | 0 | 0 |

| | | | | | | | | | | | | | | | | |
|--------------------|-----------|-----------|-----------|-----------|-----------|-----------|----------|----------|----------|----------|----------|----------|----------|----------|----------|----------|
| BIT NUMBER | 15 | 14 | 13 | 12 | 11 | 10 | 9 | 8 | 7 | 6 | 5 | 4 | 3 | 2 | 1 | 0 |
| RESET STATE | 0 | 0 | 0 | 0 | 0 | 0 | 0 | 0 | 0 | 0 | 0 | 0 | 0 | 0 | 0 | 0 |

Table 4-39. Subsystem Access Register Description

| BIT | FIELD NAME | ACCESS | DESCRIPTION |
|----------------------|-------------------|---------------|--|
| 31:16 ⁽¹⁾ | SubsystemID | RW | Subsystem ID. The value written to this field is aliased to the subsystem ID register at PCI offset 86h (see Section 4.46). |
| 15:0 ⁽¹⁾ | SubsystemVendorID | RW | Subsystem vendor ID. The value written to this field is aliased to the subsystem vendor ID register at PCI offset 84h (see Section 4.45). |

(1) This register shall only be reset by a Fundamental Reset ($\overline{\text{FRST}}$).

4.66 General Control Register

This read/write register controls various functions of the bridge. See [Table 4-40](#) for a complete description of the register contents.

PCI register offset: D4h
Register type: Read-only, Read/Write
Default value: 8600 025Fh

| | | | | | | | | | | | | | | | | |
|--------------------|-----------|-----------|-----------|-----------|-----------|-----------|-----------|-----------|-----------|-----------|-----------|-----------|-----------|-----------|-----------|-----------|
| BIT NUMBER | 31 | 30 | 29 | 28 | 27 | 26 | 25 | 24 | 23 | 22 | 21 | 20 | 19 | 18 | 17 | 16 |
| RESET STATE | 1 | 0 | 0 | 0 | 0 | 1 | 1 | 0 | 0 | 0 | 0 | 0 | 0 | 0 | 0 | 0 |

| | | | | | | | | | | | | | | | | |
|--------------------|-----------|-----------|-----------|-----------|-----------|-----------|----------|----------|----------|----------|----------|----------|----------|----------|----------|----------|
| BIT NUMBER | 15 | 14 | 13 | 12 | 11 | 10 | 9 | 8 | 7 | 6 | 5 | 4 | 3 | 2 | 1 | 0 |
| RESET STATE | 0 | 0 | 0 | 0 | 0 | 0 | 1 | 0 | 0 | 1 | 0 | 1 | 1 | 1 | 1 | 1 |

Table 4-40. General Control Register Description

| BIT | FIELD NAME | ACCESS | DESCRIPTION |
|----------------------|---------------------|---------------|--|
| 31:30 ⁽¹⁾ | CFG_RETRY_CNTR | RW | Configuration retry counter. Configures the amount of time that a configuration request must be retried on the secondary PCI bus before it may be completed with configuration retry status on the PCI Express side. 00 = 25 μ s 01 = 1 ms 10 = 25 ms (default) 11 = 50 ms |
| 29:28 | ASPM_CTRL_DEF_OVRD | RW | Active State Power Management Control Default Override. These bits are used to determine the power up default for bits 1:0 of the Link Control Register in the PCI Express Capability Structure. 00 = Power on default indicates that the active state power management is disable (00b) 01 = (default) 10 = Power on default indicates that the active state power management is enabled for L0s 11 = (01b) Power on default indicates that the active state power management is enabled for L1s (10b) Power on default indicates that the active state power management is enabled for L0s and L1s (11b) |
| 27 ⁽¹⁾ | LOW_POWER_EN | RW | Low-power enable. When this bit is set, the half-amplitude, no preemphasis mode for the PCI Express TX drivers is enabled. The default for this bit is 0b. |
| 26 ⁽¹⁾ | PCI_PM_VERSION_CTRL | RW | PCI power management version control. This bit controls the value reported in bits 2:0 (PM_VERSION) in the power management capabilities register (offset 52h, see Section 4.33). It also controls the value of bit 3 (NO_SOFT_RESET) in the power management control/status register (offset 54h, see Section 4.34). 0 = Version fields reports 010b and NO_SOFT_RESET reports 0b for Power Management 1.1 compliance 1 = Version fields reports 011b and NO_SOFT_RESET reports 1b for Power Management 1.2 compliance (default) |

(1) This register shall only be reset by a Fundamental Reset ($\overline{\text{FRST}}$).

Table 4-40. General Control Register Description (continued)

| BIT | FIELD NAME | ACCESS | DESCRIPTION |
|----------------------|--------------------|--------|--|
| 25 ⁽¹⁾ | STRICT_PRIORITY_EN | RW | <p>Strict Priority Enable. When this bit is 0, the default LOW_PRIORITY_COUNT will be '001'. When this bit is 1, the default LOW_PRIORITY_COUNT will be '000'. This default value for this bit is '1'. When this bit is set and the LOW_PRIORITY_COUNT is '000' meaning that Strict Priority VC arbitration is used and the extended virtual channel ALWAYS receives priority over VC0 at the PCI Express port.</p> <p>0 = The default LOW_PRIORITY_COUNT is 001b 1 = The default LOW_PRIORITY_COUNT is 000b (default)</p> |
| 24 ⁽¹⁾ | FORCE_MRM | RW | <p>Force memory read multiple</p> <p>0 = Memory read multiple transactions are disabled (default). 1 = All upstream memory read transactions initiated on the PCI bus are treated as though they are Memory Read Multiple transactions in which pre-fetching is supported for the transaction. This bit shall only affect the XIO2213A design when the EN_CACHE_LINE_CHECK bit in the TL Control and Diagnostic Register is set.</p> |
| 23 ⁽¹⁾ | CPM_EN_DEF_OVRD | RW | <p>Clock Power Management Enable Default Override. This bit is used to determine the power up default for bit 8 of the Link Control Register in the PCI Express Capability Structure</p> <p>0 = Power-on default indicates that clock power management is disabled (00b) (default) 1 = Power-on default indicates that clock power management is enabled for L0s and L1 (11b)</p> |
| 22:20 ⁽¹⁾ | POWER_OVRD | RW | <p>Power override. This bit field determines how the bridge responds when the slot power limit is less than the amount of power required by the bridge and the devices behind the bridge. This field shall be hardwired to 000b since XIO2213A does not support slot power limit functionality.</p> <p>000 = Ignore slot power limit (default). 001 = Assert the PWR_OVRD terminal. 010 = Disable secondary clocks selected by the clock mask register. 011 = Disable secondary clocks selected by the clock mask register and assert the PWR_OVRD terminal. 100 = Respond with unsupported request to all transactions except for configuration transactions (type 0 or type 1) and set slot power limit messages. 101, 110, 111 = Reserved</p> |
| 19 ⁽¹⁾ | READ_PREFETCH_DIS | RW | <p>Read prefetch disable. This bit controls the prefetch functionality on PCI memory read transactions.</p> <p>0 = Prefetch to the next cache line boundary on a burst read (default) 1 = Fetch only a single DWORD on a burst read</p> <p>Note: When this bit is set, the PREFETCH_4X bit in the TL Control and Diagnostic Register shall have no effect on the design. This bit shall only affect the XIO2213A when the EN_CACHE_LINE_CHECK bit in the TL Control and Diagnostic Register is set.</p> |
| 18:16 ⁽¹⁾ | L0s_LATENCY | RW | <p>L0s maximum exit latency. This field programs the maximum acceptable latency when exiting the L0s state. This sets bits 8:6 (EP_L0S_LAT) in the device capabilities register (offset 94h, see Section 4.50).</p> <p>000 = Less than 64 ns (default) 001 = 64 ns up to less than 128 ns 010 = 128 ns up to less than 256 ns 011 = 256 ns up to less than 512 ns 100 = 512 ns up to less than 1 μs 101 = 1 μs up to less than 2 μs 110 = 2 μs to 4 μs 111 = More than 4 μs</p> |
| 15:13 ⁽¹⁾ | L1_LATENCY | RW | <p>L1 maximum exit latency. This field programs the maximum acceptable latency when exiting the L1 state. This sets bits 11:9 (EP_L1_LAT) in the device capabilities register (offset 94h, see Section 4.50).</p> <p>000 = Less than 1 μs (default) 001 = 1 μs up to less than 2 μs 010 = 2 μs up to less than 4 μs 011 = 4 μs up to less than 8 μs 100 = 8 μs up to less than 16 μs 101 = 6 μs up to less than 32 μs 110 = 32 μs to 64 μs 111 = More than 64 μs</p> |

Table 4-40. General Control Register Description (continued)

| BIT | FIELD NAME | ACCESS | DESCRIPTION |
|--------------------|-----------------|--------|---|
| 12 ⁽¹⁾ | VC_CAP_EN | R | VC capability structure enable. This bit enables the VC capability structure by changing the next offset field of the advanced error reporting capability register at offset 102h. This bit is a read only 0b indicating that the VC Capability structure is permanently disabled. 0 = VC capability structure disabled (offset field = 000h) 1 = VC capability structure enabled (offset field = 150h) |
| 11 | BPCC_E | RW | Bus power clock control enable. This bit controls whether the secondary bus PCI clocks are stopped when the XIO2213A is placed in the D3 state. It is assumed that if the secondary bus clocks are required to be active, that a reference clock continues to be provided on the PCI Express interface. 0 = Secondary bus clocks are not stopped in D3 (default) 1 = Secondary bus clocks are stopped on D3 |
| 10 | BEACON_ENABLE | RW | Beacon enable. This bit controls the mechanism for waking up the physical PCI Express link when in L2. 0 = $\overline{\text{WAKE}}$ mechanism is used exclusively. Beacon is not used (default) 1 = Beacon and $\overline{\text{WAKE}}$ mechanisms are used |
| 9:8 ⁽¹⁾ | MIN_POWER_SCALE | RW | Minimum power scale. This value is programmed to indicate the scale of bits 7:0 (MIN_POWER_VALUE). 00 = 1.0x 01 = 0.1x 10 = 0.01x (default) 11 = 0.001x |
| 7:0 ⁽¹⁾ | MIN_POWER_VALUE | RW | Minimum power value. This value is programmed to indicate the minimum power requirements. This value is multiplied by the minimum power scale field (bits 9:8) to determine the minimum power requirements for the bridge. The default is 5Fh, indicating that XIO2213A requires 0.95 W of power. This field can be reprogrammed through an EEPROM or the system BIOS. |

4.67 TI Proprietary Register

This read/write TI proprietary register is located at offset D8h and controls TI proprietary functions. This register must not be changed from the specified default state. This register shall only be reset by a Fundamental Reset ($\overline{\text{FRST}}$).

PCI register offset: D8h
Register type: Read-only, Read/Write
Default value: 00h

| BIT NUMBER | 7 | 6 | 5 | 4 | 3 | 2 | 1 | 0 |
|-------------|---|---|---|---|---|---|---|---|
| RESET STATE | 0 | 0 | 0 | 0 | 0 | 0 | 0 | 0 |

4.68 TI Proprietary Register

This read/write TI proprietary register is located at offset D9h and controls TI proprietary functions. This register must not be changed from the specified default state. This register shall only be reset by a Fundamental Reset ($\overline{\text{FRST}}$).

PCI register offset: D9h
Register type: Read-only, Read/Write
Default value: 00h

| BIT NUMBER | 7 | 6 | 5 | 4 | 3 | 2 | 1 | 0 |
|-------------|---|---|---|---|---|---|---|---|
| RESET STATE | 0 | 0 | 0 | 0 | 0 | 0 | 0 | 0 |

4.69 TI Proprietary Register

This read-only TI proprietary register is located at offset DAh and controls TI proprietary functions. This register must not be changed from the specified default state. This register shall only be reset by a Fundamental Reset (FRST).

PCI register offset: DAh

Register type: Read-only

Default value: 00h

| BIT NUMBER | 7 | 6 | 5 | 4 | 3 | 2 | 1 | 0 |
|-------------|---|---|---|---|---|---|---|---|
| RESET STATE | 0 | 0 | 0 | 0 | 0 | 0 | 0 | 0 |

4.70 Arbiter Control Register

The arbiter control register controls the device's internal arbiter. The arbitration scheme used is a two-tier rotational arbitration. The device is the only secondary bus master that defaults to the higher priority arbitration tier. See [Table 4-41](#) for a complete description of the register contents.

PCI register offset: DCh
Register type: Read/Write
Default value: 40h

| | | | | | | | | |
|--------------------|----------|----------|----------|----------|----------|----------|----------|----------|
| BIT NUMBER | 7 | 6 | 5 | 4 | 3 | 2 | 1 | 0 |
| RESET STATE | 0 | 1 | 0 | 0 | 0 | 0 | 0 | 0 |

Table 4-41. Arbiter Control Register Description

| BIT | FIELD NAME | ACCESS | DESCRIPTION |
|--------------------|-----------------|--------|---|
| 7 ⁽¹⁾ | PARK | RW | Bus parking mode. This bit determines where the internal arbiter parks the secondary bus. When this bit is set, the arbiter parks the secondary bus on the bridge. When this bit is cleared, the arbiter parks the bus on the last device mastering the secondary bus. 0 = Park the secondary bus on the last secondary bus master (default) 1 = Park the secondary bus on the bridge |
| 6 ⁽¹⁾ | BRIDGE_TIER_SEL | RW | Bridge tier select. This bit determines in which tier the bridge is placed in the arbitration scheme. 0 = 0Lowest priority tier 1 = Highest priority tier (default) |
| 5:1 ⁽¹⁾ | RSVD | RW | Reserved. These bits are reserved and must not be changed from their default value of 00000b. |
| 0 ⁽¹⁾ | TIER_SEL0 | RW | GNT0 Tier Select. This bit determines in which tier GNT0 is placed in the arbitration scheme 0 = Lowest priority tier (default) 1 = Highest priority tier |

(1) This register shall only be reset by a Fundamental Reset ($\overline{\text{FRST}}$).

4.71 Arbiter Request Mask Register

The arbiter request mask register enables and disables support for requests from specific masters on the secondary bus. The arbiter request mask register also controls if a request input is automatically masked on an arbiter time-out. See [Table 4-42](#) for a complete description of the register contents.

PCI register offset: DDh
 Register type: Read/Write
 Default value: 00h

| BIT NUMBER | 7 | 6 | 5 | 4 | 3 | 2 | 1 | 0 |
|-------------|---|---|---|---|---|---|---|---|
| RESET STATE | 0 | 0 | 0 | 0 | 0 | 0 | 0 | 0 |

Table 4-42. Arbiter Request Mask Register Description

| BIT | FIELD NAME | ACCESS | DESCRIPTION |
|--------------------|-------------|--------|---|
| 7 ⁽¹⁾ | ARB_TIMEOUT | RW | Arbiter time-out. This bit enables the arbiter time-out feature. The arbiter time-out is defined as the number of PCI clocks after the PCI bus has gone idle for a device to assert $\overline{\text{FRAME}}$ before the arbiter assumes the device will not respond. 0 = Arbiter time disabled (default) 1 = Arbiter time-out set to 16 PCI clocks |
| 6 ⁽¹⁾ | AUTO_MASK | RW | Automatic request mask. This bit enables automatic request masking when an arbiter time-out occurs. 0 = Automatic request masking disabled (default) 1 = Automatic request masking enabled |
| 5:1 ⁽¹⁾ | RSVD | RW | Reserved. These bits are reserved and must not be changed from their default value of 00000b. |
| 0 ⁽¹⁾ | REQ0_MASK | RW | Request 0 (REQ0) Mask. Setting this bit forces the internal arbiter to ignore requests signal on request input 0. 0 = Use 1394a OHCI request (default) 1 = Ignore 1394a OHCI request |

(1) This register shall only be reset by a Fundamental Reset ($\overline{\text{FRST}}$).

4.72 Arbiter Time-Out Status Register

The arbiter time-out status register contains the status of each request (request 5–0) time-out. The time-out status bit for the respective request is set if the device did not assert $\overline{\text{FRAME}}$ after the arbiter time-out value. See [Table 4-43](#) for a complete description of the register contents.

PCI register offset: DEh
 Register type: Read/Clear
 Default value: 00h

| BIT NUMBER | 7 | 6 | 5 | 4 | 3 | 2 | 1 | 0 |
|-------------|---|---|---|---|---|---|---|---|
| RESET STATE | 0 | 0 | 0 | 0 | 0 | 0 | 0 | 0 |

Table 4-43. Arbiter Time-Out Status Register Description

| BIT | FIELD NAME | ACCESS | DESCRIPTION |
|-----|------------|--------|---|
| 7:6 | RSVD | R | Reserved. Returns 00b when read. |
| 5 | REQ5_TO | RCU | Request 5 Time Out Status 0 = No time-out 1 = Time-out has occurred |
| 4 | REQ4_TO | RCU | Request 4 Time Out Status 0 = No time-out 1 = Time-out has occurred |

Table 4-43. Arbiter Time-Out Status Register Description (continued)

| BIT | FIELD NAME | ACCESS | DESCRIPTION |
|-----|------------|--------|---|
| 3 | REQ3_TO | RCU | Request 3 Time Out Status 0 = No time-out 1 = Time-out has occurred |
| 2 | REQ2_TO | RCU | Request 2 Time Out Status 0 = No time-out 1 = Time-out has occurred |
| 1 | REQ1_TO | RCU | Request 1 Time Out Status 0 = No time-out 1 = Time-out has occurred |
| 0 | REQ0_TO | RCU | Request 0 Time Out Status 0 = No time-out 1 = Time-out has occurred |

4.73 TI Proprietary Register

This read/write TI proprietary register is located at offset E0h and controls TI proprietary functions. This register must not be changed from the specified default state. This register shall only be reset by a Fundamental Reset ($\overline{\text{FRST}}$).

PCI register offset: E0h
Register type: Read-only, Read/Write
Default value: 00h

| BIT NUMBER | 7 | 6 | 5 | 4 | 3 | 2 | 1 | 0 |
|-------------|---|---|---|---|---|---|---|---|
| RESET STATE | 0 | 0 | 0 | 0 | 0 | 0 | 0 | 0 |

4.74 TI Proprietary Register

This read/write TI proprietary register is located at offset E2h and controls TI proprietary functions. This register must not be changed from the specified default state. This register shall only be reset by a Fundamental Reset ($\overline{\text{FRST}}$).

PCI register offset: E2h
Register type: Read/Write
Default value: 0000h

| BIT NUMBER | 15 | 14 | 13 | 12 | 11 | 10 | 9 | 8 | 7 | 6 | 5 | 4 | 3 | 2 | 1 | 0 |
|-------------|----|----|----|----|----|----|---|---|---|---|---|---|---|---|---|---|
| RESET STATE | 0 | 0 | 0 | 0 | 0 | 0 | 0 | 0 | 0 | 0 | 0 | 0 | 0 | 0 | 0 | 0 |

4.75 TI Proprietary Register

This read/clear TI proprietary register is located at offset E4h and controls TI proprietary functions. This register must not be changed from the specified default state.

PCI register offset: E4h
Register type: Read/Clear
Default value: 0000h

| BIT NUMBER | 15 | 14 | 13 | 12 | 11 | 10 | 9 | 8 | 7 | 6 | 5 | 4 | 3 | 2 | 1 | 0 |
|-------------|----|----|----|----|----|----|---|---|---|---|---|---|---|---|---|---|
| RESET STATE | 0 | 0 | 0 | 0 | 0 | 0 | 0 | 0 | 0 | 0 | 0 | 0 | 0 | 0 | 0 | 0 |

5 PCI Express Extended Configuration Space

The programming model of the PCI Express extended configuration space is compliant to the *PCI Express Base Specification* and the *PCI Express to PCI/PCI-X Bridge Specification* programming models. The PCI Express extended configuration map uses the PCI Express advanced error reporting capability and PCI Express virtual channel (VC) capability headers.

All bits marked with a 1 are sticky bits and are reset by a global reset ($\overline{\text{GRST}}$) or the internally-generated power-on reset. All bits marked with a 0 are reset by a PCI Express reset ($\overline{\text{PERST}}$), a $\overline{\text{GRST}}$, or the internally-generated power-on reset. The remaining register bits are reset by a PCI Express hot reset, $\overline{\text{PERST}}$, $\overline{\text{GRST}}$, or the internally-generated power-on reset.

Table 5-1. PCI Express Extended Configuration Register Map

| REGISTER NAME | | OFFSET |
|--|--|-------------|
| Next capability offset / capability version | PCI Express advanced error reporting capabilities ID | 100h |
| Uncorrectable error status register ⁽¹⁾ | | 104h |
| Uncorrectable error mask register ⁽¹⁾ | | 108h |
| Uncorrectable error severity register ⁽¹⁾ | | 10Ch |
| Correctable error status register ⁽¹⁾ | | 110h |
| Correctable error mask ⁽¹⁾ | | 114h |
| Advanced error capabilities and control ⁽¹⁾ | | 118h |
| Header log register ⁽¹⁾ | | 11Ch |
| Header log register ⁽¹⁾ | | 120h |
| Header log register ⁽¹⁾ | | 124h |
| Header log register ⁽¹⁾ | | 128h |
| Secondary uncorrectable error status ⁽¹⁾ | | 12Ch |
| Secondary uncorrectable error mask ⁽¹⁾ | | 130h |
| Secondary uncorrectable error severity register ⁽¹⁾ | | 134h |
| Secondary error capabilities and control register ⁽¹⁾ | | 138h |
| Secondary header log register ⁽¹⁾ | | 13Ch |
| Secondary header log register ⁽¹⁾ | | 140h |
| Secondary header log register ⁽¹⁾ | | 144h |
| Secondary header log register ⁽¹⁾ | | 148h |
| Reserved | | 14Ch – FFCh |

(1) This register shall only be reset by a Fundamental Reset ($\overline{\text{FRST}}$).

5.1 Advanced Error Reporting Capability ID Register

This read-only register identifies the linked list item as the register for PCI Express advanced error reporting capabilities. The register returns 0001h when read.

PCI Express extended register offset: 100h
Register type: Read-only
Default value: 0001h

| BIT NUMBER | 15 | 14 | 13 | 12 | 11 | 10 | 9 | 8 | 7 | 6 | 5 | 4 | 3 | 2 | 1 | 0 |
|-------------|----|----|----|----|----|----|---|---|---|---|---|---|---|---|---|---|
| RESET STATE | 0 | 0 | 0 | 0 | 0 | 0 | 0 | 0 | 0 | 0 | 0 | 0 | 0 | 0 | 0 | 1 |

5.2 Next Capability Offset/Capability Version Register

This read-only register identifies the next location in the PCI Express extended capabilities link list. The upper 12 bits in this register shall be 000h, indicating that the Advanced Error Reporting Capability is the last capability in the linked list. The least significant four bits identify the revision of the current capability block as 1h.

XIO2213A PCI Express to 1394b OHCI with 3-Port PHY

SCPS183A–OCTOBER 2007–REVISED MARCH 2008

www.ti.com

PCI Express extended register offset: 102h
 Register type: Read-only
 Default value: 0001h

| BIT NUMBER | 15 | 14 | 13 | 12 | 11 | 10 | 9 | 8 | 7 | 6 | 5 | 4 | 3 | 2 | 1 | 0 |
|-------------|----|----|----|----|----|----|---|---|---|---|---|---|---|---|---|---|
| RESET STATE | 0 | 0 | 0 | 0 | 0 | 0 | 0 | 0 | 0 | 0 | 0 | 0 | 0 | 0 | 0 | 1 |

5.3 Uncorrectable Error Status Register

The uncorrectable error status register reports the status of individual errors as they occur on the primary PCI Express interface. Software may only clear these bits by writing a 1b to the desired location. See [Table 5-2](#) for a complete description of the register contents.

PCI Express extended register offset: 104h
Register type: Read-only, Read/Clear
Default value: 0000h

| | | | | | | | | | | | | | | | | |
|--------------------|-----------|-----------|-----------|-----------|-----------|-----------|-----------|-----------|-----------|-----------|-----------|-----------|-----------|-----------|-----------|-----------|
| BIT NUMBER | 31 | 30 | 29 | 28 | 27 | 26 | 25 | 24 | 23 | 22 | 21 | 20 | 19 | 18 | 17 | 16 |
| RESET STATE | 0 | 0 | 0 | 0 | 0 | 0 | 0 | 0 | 0 | 0 | 0 | 0 | 0 | 0 | 0 | 0 |
| BIT NUMBER | 15 | 14 | 13 | 12 | 11 | 10 | 9 | 8 | 7 | 6 | 5 | 4 | 3 | 2 | 1 | 0 |
| RESET STATE | 0 | 0 | 0 | 0 | 0 | 0 | 0 | 0 | 0 | 0 | 0 | 0 | 0 | 0 | 0 | 0 |

Table 5-2. Uncorrectable Error Status Register Description

| BIT | FIELD NAME | ACCESS | DESCRIPTION |
|-------------------|-------------|--------|---|
| 31:21 | RSVD | R | Reserved. Returns 000 0000 0000b when read. |
| 20 ⁽¹⁾ | UR_ERROR | RCU | Unsupported request error. This bit is asserted when an unsupported request is received. |
| 19 ⁽¹⁾ | ECRC_ERROR | RCU | Extended CRC error. This bit is asserted when an extended CRC error is detected. |
| 18 ⁽¹⁾ | MAL_TLP | RCU | Malformed TLP. This bit is asserted when a malformed TLP is detected. |
| 17 ⁽¹⁾ | RX_OVERFLOW | RCU | Receiver overflow. This bit is asserted when the flow control logic detects that the transmitting device has illegally exceeded the number of credits that were issued. |
| 16 ⁽¹⁾ | UNXP_CPL | RCU | Unexpected completion. This bit is asserted when a completion packet is received that does not correspond to an issued request. |
| 15 ⁽¹⁾ | CPL_ABORT | RCU | Completer abort. This bit is asserted when the bridge signals a completer abort. |
| 14 ⁽¹⁾ | CPL_TIMEOUT | RCU | Completion time-out. This bit is asserted when no completion has been received for an issued request before the time-out period. |
| 13 ⁽¹⁾ | FC_ERROR | RCU | Flow control error. This bit is asserted when a flow control protocol error is detected either during initialization or during normal operation. |
| 12 ⁽¹⁾ | PSN_TLP | RCU | Poisoned TLP. This bit is asserted when a poisoned TLP is received. |
| 11:5 | RSVD | R | Reserved. Returns 000 0000b when read. |
| 4 ⁽¹⁾ | DLL_ERROR | RCU | Data link protocol error. This bit is asserted if a data link layer protocol error is detected. |
| 3:0 | RSVD | R | Reserved. Returns 0h when read. |

(1) This register shall only be reset by a Fundamental Reset ($\overline{\text{FRST}}$).

5.4 Uncorrectable Error Mask Register

The uncorrectable error mask register controls the reporting of individual errors as they occur. When a mask bit is set to 1b, the corresponding error status bit is not set, PCI Express error messages are blocked, the header log is not loaded, and the first error pointer is not updated. See [Table 5-3](#) for a complete description of the register contents.

PCI Express extended register offset: 108h
Register type: Read-only, Read/Write
Default value: 0000h

| | | | | | | | | | | | | | | | | |
|--------------------|-----------|-----------|-----------|-----------|-----------|-----------|-----------|-----------|-----------|-----------|-----------|-----------|-----------|-----------|-----------|-----------|
| BIT NUMBER | 31 | 30 | 29 | 28 | 27 | 26 | 25 | 24 | 23 | 22 | 21 | 20 | 19 | 18 | 17 | 16 |
| RESET STATE | 0 | 0 | 0 | 0 | 0 | 0 | 0 | 0 | 0 | 0 | 0 | 0 | 0 | 0 | 0 | 0 |
| BIT NUMBER | 15 | 14 | 13 | 12 | 11 | 10 | 9 | 8 | 7 | 6 | 5 | 4 | 3 | 2 | 1 | 0 |
| RESET STATE | 0 | 0 | 0 | 0 | 0 | 0 | 0 | 0 | 0 | 0 | 0 | 0 | 0 | 0 | 0 | 0 |

Table 5-3. Uncorrectable Error Mask Register Description

| BIT | FIELD NAME | ACCESS | DESCRIPTION |
|-------------------|------------------|--------|--|
| 31:21 | RSVD | R | Reserved. Returns 000 0000 0000b when read. |
| 20 ⁽¹⁾ | UR_ERROR_MASK | RW | Unsupported request error mask 0 = Error condition is unmasked (default) 1 = Error condition is masked |
| 19 ⁽¹⁾ | ECRC_ERROR_MASK | RW | Extended CRC error mask 0 = Error condition is unmasked (default) 1 = Error condition is masked |
| 18 ⁽¹⁾ | MAL_TLP_MASK | RW | Malformed TLP mask 0 = Error condition is unmasked (default) 1 = Error condition is masked |
| 17 ⁽¹⁾ | RX_OVERFLOW_MASK | RW | Receiver overflow mask 0 = Error condition is unmasked (default) 1 = Error condition is masked |
| 16 ⁽¹⁾ | UNXP_CPL_MASK | RW | Unexpected completion mask 0 = Error condition is unmasked (default) 1 = Error condition is masked |
| 15 ⁽¹⁾ | CPL_ABORT_MASK | RW | Completer abort mask 0 = Error condition is unmasked (default) 1 = Error condition is masked |
| 14 ⁽¹⁾ | CPL_TIMEOUT_MASK | RW | Completion time-out mask 0 = Error condition is unmasked (default) 1 = Error condition is masked |
| 13 ⁽¹⁾ | FC_ERROR_MASK | RW | Flow control error mask 0 = Error condition is unmasked (default) 1 = Error condition is masked |
| 12 ⁽¹⁾ | PSN_TLP_MASK | RW | Poisoned TLP mask 0 = Error condition is unmasked (default) 1 = Error condition is masked |
| 11:5 | RSVD | R | Reserved. Returns 000 0000b when read. |
| 4 ⁽¹⁾ | DLL_ERROR_MASK | RW | Data link protocol error mask 0 = Error condition is unmasked (default) 1 = Error condition is masked |
| 3:0 | RSVD | R | Reserved. Returns 0h when read. |

(1) This register shall only be reset by a Fundamental Reset ($\overline{\text{FRST}}$).

5.5 Uncorrectable Error Severity Register

The uncorrectable error severity register controls the reporting of individual errors as ERR_FATAL or ERR_NONFATAL. When a bit is set, the corresponding error condition is identified as fatal. When a bit is cleared, the corresponding error condition is identified as nonfatal. See [Table 5-4](#) for a complete description of the register contents.

PCI Express extended register offset: 10Ch
Register type: Read-only, Read/Write
Default value: 0006 2011h

| | | | | | | | | | | | | | | | | |
|--------------------|-----------|-----------|-----------|-----------|-----------|-----------|-----------|-----------|-----------|-----------|-----------|-----------|-----------|-----------|-----------|-----------|
| BIT NUMBER | 31 | 30 | 29 | 28 | 27 | 26 | 25 | 24 | 23 | 22 | 21 | 20 | 19 | 18 | 17 | 16 |
| RESET STATE | 0 | 0 | 0 | 0 | 0 | 0 | 0 | 0 | 0 | 0 | 0 | 0 | 0 | 1 | 1 | 0 |

| | | | | | | | | | | | | | | | | |
|--------------------|-----------|-----------|-----------|-----------|-----------|-----------|----------|----------|----------|----------|----------|----------|----------|----------|----------|----------|
| BIT NUMBER | 15 | 14 | 13 | 12 | 11 | 10 | 9 | 8 | 7 | 6 | 5 | 4 | 3 | 2 | 1 | 0 |
| RESET STATE | 0 | 0 | 1 | 0 | 0 | 0 | 0 | 0 | 0 | 0 | 1 | 1 | 0 | 0 | 0 | 1 |

Table 5-4. Uncorrectable Error Severity Register Description

| BIT | FIELD NAME | ACCESS | DESCRIPTION |
|-------------------|------------------|--------|---|
| 31:21 | RSVD | R | Reserved. Returns 000 0000 0000b when read. |
| 20 ⁽¹⁾ | UR_ERROR_SEVRO | RW | Unsupported request error severity 0 = Error condition is signaled using ERR_NONFATAL 1 = Error condition is signaled using ERR_FATAL |
| 19 ⁽¹⁾ | ECRC_ERROR_SEVRR | RW | Extended CRC error severity 0 = Error condition is signaled using ERR_NONFATAL 1 = Error condition is signaled using ERR_FATAL |
| 18 ⁽¹⁾ | MAL_TLP_SEVR | RW | Malformed TLP severity 0 = Error condition is signaled using ERR_NONFATAL 1 = Error condition is signaled using ERR_FATAL |
| 17 ⁽¹⁾ | RX_OVERFLOW_SEVR | RW | Receiver overflow severity 0 = Error condition is signaled using ERR_NONFATAL 1 = Error condition is signaled using ERR_FATAL |
| 16 ⁽¹⁾ | UNXP_CPL_SEVRP | RW | Unexpected completion severity 0 = Error condition is signaled using ERR_NONFATAL 1 = Error condition is signaled using ERR_FATAL |
| 15 ⁽¹⁾ | CPL_ABORT_SEVR | RW | Completer abort severity 0 = Error condition is signaled using ERR_NONFATAL 1 = Error condition is signaled using ERR_FATAL |
| 14 ⁽¹⁾ | CPL_TIMEOUT_SEVR | RW | Completion time-out severit 0 = Error condition is signaled using ERR_NONFATAL 1 = Error condition is signaled using ERR_FATAL |
| 13 ⁽¹⁾ | FC_ERROR_SEVR | RW | Flow control error severity 0 = Error condition is signaled using ERR_NONFATAL 1 = Error condition is signaled using ERR_FATAL |
| 12 ⁽¹⁾ | PSN_TLP_SEVR | RW | Poisoned TLP severity 0 = Error condition is signaled using ERR_NONFATAL 1 = Error condition is signaled using ERR_FATAL |
| 11:6 | RSVD | R | Reserved. Returns 000 000b when read. |
| 5 | RSVD | R | Reserved. Returns 1h when read |
| 4 ⁽¹⁾ | DLL_ERROR_SEVR | RW | Data link protocol error severity 0 = Error condition is signaled using ERR_NONFATAL 1 = Error condition is signaled using ERR_FATAL |
| 3:1 | RSVD | R | Reserved. Returns 000b when read. |
| 0 | RSVD | R | Reserved. Returns 1h when read. |

(1) This register shall only be reset by a Fundamental Reset (FRST).

5.6 Correctable Error Status Register

The correctable error status register reports the status of individual errors as they occur. Software may only clear these bits by writing a 1b to the desired location. See [Table 5-5](#) for a complete description of the register contents.

PCI Express extended register offset: 110h
 Register type: Read-only, Read/Clear
 Default value: 0000 0000h

| | | | | | | | | | | | | | | | | |
|--------------------|-----------|-----------|-----------|-----------|-----------|-----------|-----------|-----------|-----------|-----------|-----------|-----------|-----------|-----------|-----------|-----------|
| BIT NUMBER | 31 | 30 | 29 | 28 | 27 | 26 | 25 | 24 | 23 | 22 | 21 | 20 | 19 | 18 | 17 | 16 |
| RESET STATE | 0 | 0 | 0 | 0 | 0 | 0 | 0 | 0 | 0 | 0 | 0 | 0 | 0 | 0 | 0 | 0 |
| BIT NUMBER | 15 | 14 | 13 | 12 | 11 | 10 | 9 | 8 | 7 | 6 | 5 | 4 | 3 | 2 | 1 | 0 |
| RESET STATE | 0 | 0 | 0 | 0 | 0 | 0 | 0 | 0 | 0 | 0 | 0 | 0 | 0 | 0 | 0 | 0 |

Table 5-5. Correctable Error Status Register Description

| BIT | FIELD NAME | ACCESS | DESCRIPTION |
|-------------------|--------------|--------|---|
| 31:14 | RSVD | R | Reserved. Returns 000 0000 0000 0000 0000b when read. |
| 13 | ANFES | RCU | Advisory Non-Fatal Error Status. This bit is asserted when an Advisor Non-Fatal Error has been reported. |
| 12 ⁽¹⁾ | REPLAY_TMOUT | RCU | Replay timer time-out. This bit is asserted when the replay timer expires for a pending request or completion that has not been acknowledged. |
| 11:9 | RSVD | R | Reserved. Returns 000b when read. |
| 8 ⁽¹⁾ | REPLAY_ROLL | RCU | REPLAY_NUM rollover. This bit is asserted when the replay counter rolls over after a pending request or completion has not been acknowledged. |
| 7 ⁽¹⁾ | BAD_DLLP | RCU | Bad DLLP error. This bit is asserted when an 8b/10b error was detected by the PHY during the reception of a DLLP. |
| 6 ⁽¹⁾ | BAD_TLP | RCU | Bad TLP error. This bit is asserted when an 8b/10b error was detected by the PHY during the reception of a TLP. |
| 5:1 | RSVD | R | Reserved. Returns 00000b when read. |
| 0 ⁽¹⁾ | RX_ERROR | RCU | Receiver error. This bit is asserted when an 8b/10b error is detected by the PHY at any time. |

(1) This register shall only be reset by a Fundamental Reset ($\overline{\text{FRST}}$).

5.7 Correctable Error Mask Register

The correctable error mask register controls the reporting of individual errors as they occur. When a mask bit is set to 1b, the corresponding error status bit is not set, PCI Express error messages are blocked, the header log is not loaded, and the first error pointer is not updated. See [Table 5-6](#) for a complete description of the register contents.

PCI Express extended register offset: 114h
Register type: Read-only, Read/Write
Default value: 0000 2000h

| | | | | | | | | | | | | | | | | |
|--------------------|-----------|-----------|-----------|-----------|-----------|-----------|-----------|-----------|-----------|-----------|-----------|-----------|-----------|-----------|-----------|-----------|
| BIT NUMBER | 31 | 30 | 29 | 28 | 27 | 26 | 25 | 24 | 23 | 22 | 21 | 20 | 19 | 18 | 17 | 16 |
| RESET STATE | 0 | 0 | 0 | 0 | 0 | 0 | 0 | 0 | 0 | 0 | 0 | 0 | 0 | 0 | 0 | 0 |

| | | | | | | | | | | | | | | | | |
|--------------------|-----------|-----------|-----------|-----------|-----------|-----------|----------|----------|----------|----------|----------|----------|----------|----------|----------|----------|
| BIT NUMBER | 15 | 14 | 13 | 12 | 11 | 10 | 9 | 8 | 7 | 6 | 5 | 4 | 3 | 2 | 1 | 0 |
| RESET STATE | 0 | 0 | 1 | 0 | 0 | 0 | 0 | 0 | 0 | 0 | 0 | 0 | 0 | 0 | 0 | 0 |

Table 5-6. Correctable Error Mask Register Description

| BIT | FIELD NAME | ACCESS | DESCRIPTION |
|-------------------|-------------------|--------|--|
| 31:14 | RSVD | R | Reserved. Returns 000 0000 0000 0000b when read. |
| 13 | ANFEM | RW | Advisory Non-Fatal Error Mask. 0 = Error condition is unmasked 1 = Error condition is masked (default) |
| 12 ⁽¹⁾ | REPLAY_TMOUT_MASK | RW | Replay timer time-out mask. 0 = Error condition is unmasked (default) 1 = Error condition is masked |
| 11:9 | RSVD | R | Reserved. Returns 000b when read. |
| 8 ⁽¹⁾ | REPLAY_ROLL_MASK | RW | REPLAY_NUM rollover mask. 0 = Error condition is unmasked (default) 1 = Error condition is masked |
| 7 ⁽¹⁾ | BAD_DLLP_MASK | RW | Bad DLLP error mask. 0 = Error condition is unmasked (default) 1 = Error condition is masked |
| 6 ⁽¹⁾ | BAD_TLP_MASK | RW | Bad TLP error mask. 0 = Error condition is unmasked (default) 1 = Error condition is masked |
| 5:1 | RSVD | R | Reserved. Returns 00000b when read. |
| 0 ⁽¹⁾ | RX_ERROR_MASK | RW | Receiver error mask. 0 = Error condition is unmasked (default) 1 = Error condition is masked |

(1) This register shall only be reset by a Fundamental Reset ($\overline{\text{FRST}}$).

5.8 Advanced Error Capabilities and Control Register

The advanced error capabilities and control register allows the system to monitor and control the advanced error reporting capabilities. See [Table 5-7](#) for a complete description of the register contents.

PCI Express extended register offset: 118h
 Register type: Read-only, Read/Write
 Default value: 0000 00A0h

| | | | | | | | | | | | | | | | | |
|--------------------|-----------|-----------|-----------|-----------|-----------|-----------|-----------|-----------|-----------|-----------|-----------|-----------|-----------|-----------|-----------|-----------|
| BIT NUMBER | 31 | 30 | 29 | 28 | 27 | 26 | 25 | 24 | 23 | 22 | 21 | 20 | 19 | 18 | 17 | 16 |
| RESET STATE | 0 | 0 | 0 | 0 | 0 | 0 | 0 | 0 | 0 | 0 | 0 | 0 | 0 | 0 | 0 | 0 |
| BIT NUMBER | 15 | 14 | 13 | 12 | 11 | 10 | 9 | 8 | 7 | 6 | 5 | 4 | 3 | 2 | 1 | 0 |
| RESET STATE | 0 | 0 | 0 | 0 | 0 | 0 | 0 | 0 | 1 | 0 | 1 | 0 | 0 | 0 | 0 | 0 |

Table 5-7. Advanced Error Capabilities and Control Register Description

| BIT | FIELD NAME | ACCESS | DESCRIPTION |
|--------------------|------------------|--------|---|
| 31:9 | RSVD | R | Reserved. Returns 000 0000 0000 0000 0000 0000b when read. |
| 8 ⁽¹⁾ | ECRC_CHK_EN | RW | Extended CRC check enable 0 = Extended CRC checking is disabled 1 = Extended CRC checking is enabled |
| 7 | ECRC_CHK_CAPABLE | R | Extended CRC check capable. This read-only bit returns a value of 1b indicating that the bridge is capable of checking extended CRC information. |
| 6 ⁽¹⁾ | ECRC_GEN_EN | RW | Extended CRC generation enable 0 = Extended CRC generation is disabled 1 = Extended CRC generation is enabled |
| 5 | ECRC_GEN_CAPABLE | R | Extended CRC generation capable. This read-only bit returns a value of 1b indicating that the bridge is capable of generating extended CRC information. |
| 4:0 ⁽¹⁾ | FIRST_ERR | RU | First error pointer. This 5-bit value reflects the bit position within the uncorrectable error status register (offset 104h, see Section 5.3) corresponding to the class of the first error condition that was detected. |

(1) This register shall only be reset by a Fundamental Reset ($\overline{\text{FRST}}$).

5.9 Header Log Register

The header log register stores the TLP header for the packet that lead to the most recently detected error condition. Offset 11Ch contains the first DWORD. Offset 128h contains the last DWORD (in the case of a 4DW TLP header). Each DWORD is stored with the least significant byte representing the earliest transmitted. This register shall only be reset by a Fundamental Reset ($\overline{\text{FRST}}$).

PCI Express extended register offset: 11Ch, 120h, 124h, and 128h
 Register type: Read-only
 Default value: 0000 0000h

| | | | | | | | | | | | | | | | | |
|--------------------|-----------|-----------|-----------|-----------|-----------|-----------|-----------|-----------|-----------|-----------|-----------|-----------|-----------|-----------|-----------|-----------|
| BIT NUMBER | 31 | 30 | 29 | 28 | 27 | 26 | 25 | 24 | 23 | 22 | 21 | 20 | 19 | 18 | 17 | 16 |
| RESET STATE | 0 | 0 | 0 | 0 | 0 | 0 | 0 | 0 | 0 | 0 | 0 | 0 | 0 | 0 | 0 | 0 |
| BIT NUMBER | 15 | 14 | 13 | 12 | 11 | 10 | 9 | 8 | 7 | 6 | 5 | 4 | 3 | 2 | 1 | 0 |
| RESET STATE | 0 | 0 | 0 | 0 | 0 | 0 | 0 | 0 | 0 | 0 | 0 | 0 | 0 | 0 | 0 | 0 |

5.10 Secondary Uncorrectable Error Status Register

The secondary uncorrectable error status register reports the status of individual PCI bus errors as they occur. Software may only clear these bits by writing a 1b to the desired location. See [Table 5-8](#) for a complete description of the register contents.

PCI Express extended register offset: 12Ch
Register type: Read-only, Read/Clear
Default value: 0000 0000h

| | | | | | | | | | | | | | | | | |
|--------------------|-----------|-----------|-----------|-----------|-----------|-----------|-----------|-----------|-----------|-----------|-----------|-----------|-----------|-----------|-----------|-----------|
| BIT NUMBER | 31 | 30 | 29 | 28 | 27 | 26 | 25 | 24 | 23 | 22 | 21 | 20 | 19 | 18 | 17 | 16 |
| RESET STATE | 0 | 0 | 0 | 0 | 0 | 0 | 0 | 0 | 0 | 0 | 0 | 0 | 0 | 0 | 0 | 0 |
| BIT NUMBER | 15 | 14 | 13 | 12 | 11 | 10 | 9 | 8 | 7 | 6 | 5 | 4 | 3 | 2 | 1 | 0 |
| RESET STATE | 0 | 0 | 0 | 0 | 0 | 0 | 0 | 0 | 0 | 0 | 0 | 0 | 0 | 0 | 0 | 0 |

Table 5-8. Secondary Uncorrectable Error Status Register Description

| BIT | FIELD NAME | ACCESS | DESCRIPTION |
|-------------------|---------------|--------|--|
| 31:13 | RSVD | R | Reserved. Returns 000 0000 0000 0000 0000b when read. |
| 12 ⁽¹⁾ | SERR_DETECT | RCU | SERR assertion detected. This bit is asserted when the bridge detects the assertion of SERR on the secondary bus. |
| 11 ⁽¹⁾ | PERR_DETECT | RCU | PERR assertion detected. This bit is asserted when the bridge detects the assertion of PERR on the secondary bus. |
| 10 ⁽¹⁾ | DISCARD_TIMER | RCU | Delayed transaction discard timer expired. This bit is asserted when the discard timer expires for a pending delayed transaction that was initiated on the secondary bus. |
| 9 ⁽¹⁾ | UNCOR_ADDR | RCU | Uncorrectable address error. This bit is asserted when the bridge detects a parity error during the address phase of an upstream transaction. |
| 8 | RSVD | R | Reserved. Returns 0b when read. |
| 7 ⁽¹⁾ | UNCOR_DATA | RCU | Uncorrectable data error. This bit is asserted when the bridge detects a parity error during a data phase of an upstream write transaction, or when the bridge detects the assertion of PERR when forwarding read completion data to a PCI device. |
| 6:4 | RSVD | R | Reserved. Returns 000b when read. |
| 3 ⁽¹⁾ | MASTER_ABORT | RCU | Received master abort. This bit is asserted when the bridge receives a master abort on the PCI interface. |
| 2 ⁽¹⁾ | TARGET_ABORT | RCU | Received target abort. This bit is asserted when the bridge receives a target abort on the PCI interface. |
| 1:0 | RSVD | R | Reserved. Returns 00b when read. |

(1) This register shall only be reset by a Fundamental Reset ($\overline{\text{FRST}}$).

5.11 Secondary Uncorrectable Error Mask Register

The secondary uncorrectable error mask register controls the reporting of individual errors as they occur. When a mask bit is set to 1b, the corresponding error status bit is not set, PCI Express error messages are blocked, the header log is not loaded, and the first error pointer is not updated. See [Table 5-9](#) for a complete description of the register contents.

PCI Express extended register offset: 130h
 Register type: Read-only, Read/Write
 Default value: 0000 17A8h

| | | | | | | | | | | | | | | | | |
|--------------------|-----------|-----------|-----------|-----------|-----------|-----------|-----------|-----------|-----------|-----------|-----------|-----------|-----------|-----------|-----------|-----------|
| BIT NUMBER | 31 | 30 | 29 | 28 | 27 | 26 | 25 | 24 | 23 | 22 | 21 | 20 | 19 | 18 | 17 | 16 |
| RESET STATE | 0 | 0 | 0 | 0 | 0 | 0 | 0 | 0 | 0 | 0 | 0 | 0 | 0 | 0 | 0 | 0 |

| | | | | | | | | | | | | | | | | |
|--------------------|-----------|-----------|-----------|-----------|-----------|-----------|----------|----------|----------|----------|----------|----------|----------|----------|----------|----------|
| BIT NUMBER | 15 | 14 | 13 | 12 | 11 | 10 | 9 | 8 | 7 | 6 | 5 | 4 | 3 | 2 | 1 | 0 |
| RESET STATE | 0 | 0 | 0 | 1 | 0 | 1 | 1 | 1 | 1 | 0 | 1 | 0 | 1 | 0 | 0 | 0 |

Table 5-9. Secondary Uncorrectable Error Mask Register Description

| BIT | FIELD NAME | ACCESS | DESCRIPTION |
|-------------------|--------------------|---------------|--|
| 31:14 | RSVD | R | Reserved. Returns 00 0000 0000 0000 0000b when read. |
| 13 ⁽¹⁾ | BRIDGE_ERROR_MASK | RW | Internal bridge error. This mask bit is associated with a PCI-X error and has no effect on the bridge. |
| 12 ⁽¹⁾ | SERR_DETECT_MASK | RW | SERR assertion detected 0 = Error condition is unmasked 1 = Error condition is masked (default) |
| 11 ⁽¹⁾ | PERR_DETECT_MASK | RW | PERR assertion detected 0 = Error condition is unmasked 1 = Error condition is masked (default) |
| 10 ⁽¹⁾ | DISCARD_TIMER_MASK | RW | Delayed transaction discard timer expired 0 = Error condition is unmasked 1 = Error condition is masked (default) |
| 9 ⁽¹⁾ | UNCOR_ADDR_MASK | RW | Uncorrectable address error 0 = Error condition is unmasked 1 = Error condition is masked (default) |
| 8 ⁽¹⁾ | ATTR_ERROR_MASK | RW | Uncorrectable attribute error. This mask bit is associated with a PCI-X error and has no effect on the bridge. |
| 7 ⁽¹⁾ | UNCOR_DATA_MASK | RW | Uncorrectable data error 0 = Error condition is unmasked 1 = Error condition is masked (default) |
| 6 ⁽¹⁾ | SC_MSG_DATA_MASK | RW | Uncorrectable split completion message data error. This mask bit is associated with a PCI-X error and has no effect on the bridge. |
| 5 ⁽¹⁾ | SC_ERROR_MASK | RW | Unexpected split completion error. This mask bit is associated with a PCI-X error and has no effect on the bridge. |
| 4 | RSVD | R | Reserved. Returns 0b when read. |
| 3 ⁽¹⁾ | MASTER_ABORT_MASK | RW | Received master abort 0 = Error condition is unmasked 1 = Error condition is masked (default) |
| 2 ⁽¹⁾ | TARGET_ABORT_MASK | RW | Received target abort 0 = Error condition is unmasked 1 = Error condition is masked (default) |
| 1 ⁽¹⁾ | SC_MSTR_ABORT_MASK | RW | Master abort on split completion. This mask bit is associated with a PCI-X error and has no effect on the bridge. |
| 0 | RSVD | R | Reserved. Returns 0b when read. |

(1) This register shall only be reset by a Fundamental Reset ($\overline{\text{FRST}}$).

5.12 Secondary Uncorrectable Error Severity

The uncorrectable error severity register controls the reporting of individual errors as ERR_FATAL or ERR_NONFATAL. When a bit is set, the corresponding error condition is identified as fatal. When a bit is cleared, the corresponding error condition is identified as nonfatal. See [Table 5-10](#) for a complete description of the register contents.

PCI Express extended register offset: 134h
Register type: Read-only, Read/Write
Default value: 0000 1340h

| BIT NUMBER | 31 | 30 | 29 | 28 | 27 | 26 | 25 | 24 | 23 | 22 | 21 | 20 | 19 | 18 | 17 | 16 |
|-------------|----|----|----|----|----|----|----|----|----|----|----|----|----|----|----|----|
| RESET STATE | 0 | 0 | 0 | 0 | 0 | 0 | 0 | 0 | 0 | 0 | 0 | 0 | 0 | 0 | 0 | 0 |

| BIT NUMBER | 15 | 14 | 13 | 12 | 11 | 10 | 9 | 8 | 7 | 6 | 5 | 4 | 3 | 2 | 1 | 0 |
|-------------|----|----|----|----|----|----|---|---|---|---|---|---|---|---|---|---|
| RESET STATE | 0 | 0 | 0 | 1 | 0 | 0 | 1 | 1 | 0 | 1 | 0 | 0 | 0 | 0 | 0 | 0 |

Table 5-10. Secondary Uncorrectable Error Severity Register Description

| BIT | FIELD NAME | ACCESS | DESCRIPTION |
|-------------------|--------------------|--------|--|
| 31:14 | RSVD | R | Reserved. Returns 00 0000 0000 0000 0000b when read. |
| 13 ⁽¹⁾ | BRIDGE_ERROR_SEVR | RW | Internal bridge error. This severity bit is associated with a PCI-X error and has no effect on the bridge. |
| 12 ⁽¹⁾ | SERR_DETECT_SEVR | RW | $\overline{\text{SERR}}$ assertion detected 0 = Error condition is signaled using ERR_NONFATAL 1 = Error condition is signaled using ERR_FATAL (default) |
| 11 ⁽¹⁾ | PERR_DETECT_SEVR | RW | $\overline{\text{PERR}}$ assertion detected 0 = Error condition is signaled using ERR_NONFATAL (default) 1 = Error condition is signaled using ERR_FATAL |
| 10 ⁽¹⁾ | DISCARD_TIMER_SEVR | RW | Delayed transaction discard timer expired 0 = Error condition is signaled using ERR_NONFATAL (default) 1 = Error condition is signaled using ERR_FATAL |
| 9 ⁽¹⁾ | UNCOR_ADDR_SEVR | RW | Uncorrectable address error 0 = Error condition is signaled using ERR_NONFATAL 1 = Error condition is signaled using ERR_FATAL (default) |
| 8 ⁽¹⁾ | ATTR_ERROR_SEVR | RW | Uncorrectable attribute error. This severity bit is associated with a PCI-X error and has no effect on the bridge. |
| 7 ⁽¹⁾ | UNCOR_DATA_SEVR | RW | Uncorrectable data error 0 = Error condition is signaled using ERR_NONFATAL (default) 1 = Error condition is signaled using ERR_FATAL |
| 6 ⁽¹⁾ | SC_MSG_DATA_SEVR | RW | Uncorrectable split completion message data error. This severity bit is associated with a PCI-X error and has no effect on the bridge. |
| 5 ⁽¹⁾ | SC_ERROR_SEVR | RW | Unexpected split completion error. This severity bit is associated with a PCI-X error and has no effect on the bridge. |
| 4 | RSVD | R | Reserved. Returns 0b when read. |
| 3 ⁽¹⁾ | MASTER_ABORT_SEVR | RW | Received master abort 0 = Error condition is signaled using ERR_NONFATAL (default) 1 = Error condition is signaled using ERR_FATAL |
| 2 ⁽¹⁾ | TARGET_ABORT_SEVR | RW | Received target abort 0 = Error condition is signaled using ERR_NONFATAL (default) 1 = Error condition is signaled using ERR_FATAL |
| 1 ⁽¹⁾ | SC_MSTR_ABORT_SEVR | RW | Master abort on split completion. This severity bit is associated with a PCI-X error and has no effect on the bridge. |
| 0 | RSVD | R | Reserved. Returns 0b when read. |

(1) This register shall only be reset by a Fundamental Reset ($\overline{\text{FRST}}$).

5.13 Secondary Error Capabilities and Control Register

The secondary error capabilities and control register allows the system to monitor and control the secondary advanced error reporting capabilities. See [Table 5-11](#) for a complete description of the register contents.

PCI Express extended register offset: 138h
 Register type: Read-only
 Default value: 0000 0000h

| | | | | | | | | | | | | | | | | |
|--------------------|-----------|-----------|-----------|-----------|-----------|-----------|-----------|-----------|-----------|-----------|-----------|-----------|-----------|-----------|-----------|-----------|
| BIT NUMBER | 31 | 30 | 29 | 28 | 27 | 26 | 25 | 24 | 23 | 22 | 21 | 20 | 19 | 18 | 17 | 16 |
| RESET STATE | 0 | 0 | 0 | 0 | 0 | 0 | 0 | 0 | 0 | 0 | 0 | 0 | 0 | 0 | 0 | 0 |

| | | | | | | | | | | | | | | | | |
|--------------------|-----------|-----------|-----------|-----------|-----------|-----------|----------|----------|----------|----------|----------|----------|----------|----------|----------|----------|
| BIT NUMBER | 15 | 14 | 13 | 12 | 11 | 10 | 9 | 8 | 7 | 6 | 5 | 4 | 3 | 2 | 1 | 0 |
| RESET STATE | 0 | 0 | 0 | 0 | 0 | 0 | 0 | 0 | 0 | 0 | 0 | 0 | 0 | 0 | 0 | 0 |

Table 5-11. Secondary Error Capabilities and Control Register Description

| BIT | FIELD NAME | ACCESS | DESCRIPTION |
|--------------------|-------------------|---------------|---|
| 31:5 | RSVD | R | Reserved. Return 000 0000 0000 0000 0000 0000 0000b when read. |
| 4:0 ⁽¹⁾ | SEC_FIRST_ERR | RU | First error pointer. This 5-bit value reflects the bit position within the secondary uncorrectable error status register (offset12Ch, see Section 5.10) corresponding to the class of the first error condition that was detected. |

(1) This register shall only be reset by a Fundamental Reset ($\overline{\text{FRST}}$).

5.14 Secondary Header Log Register

The secondary header log register stores the transaction address and command for the PCI bus cycle that led to the most recently detected error condition. Offset 13Ch accesses register bits 31:0. Offset 140h accesses register bits 63:32. Offset 144h accesses register bits 95:64. Offset 148h accesses register bits 127:96. See [Table 5-12](#) for a complete description of the register contents.

PCI Express extended register offset: 13Ch, 140h, 144h, and 148h

Register type: Read-only

Default value: 0000 0000h

| | | | | | | | | | | | | | | | | |
|--------------------|------------|------------|------------|------------|------------|------------|------------|------------|------------|------------|------------|------------|------------|------------|------------|------------|
| BIT NUMBER | 127 | 126 | 125 | 124 | 123 | 122 | 121 | 120 | 119 | 118 | 117 | 116 | 115 | 114 | 113 | 112 |
| RESET STATE | 0 | 0 | 0 | 0 | 0 | 0 | 0 | 0 | 0 | 0 | 0 | 0 | 0 | 0 | 0 | 0 |
| BIT NUMBER | 111 | 110 | 109 | 108 | 107 | 106 | 105 | 104 | 103 | 102 | 101 | 100 | 99 | 98 | 97 | 96 |
| RESET STATE | 0 | 0 | 0 | 0 | 0 | 0 | 0 | 0 | 0 | 0 | 0 | 0 | 0 | 0 | 0 | 0 |
| BIT NUMBER | 95 | 94 | 93 | 92 | 91 | 90 | 89 | 88 | 87 | 86 | 85 | 84 | 83 | 82 | 81 | 80 |
| RESET STATE | 0 | 0 | 0 | 0 | 0 | 0 | 0 | 0 | 0 | 0 | 0 | 0 | 0 | 0 | 0 | 0 |
| BIT NUMBER | 79 | 78 | 77 | 76 | 75 | 74 | 73 | 72 | 71 | 70 | 69 | 68 | 67 | 66 | 65 | 64 |
| RESET STATE | 0 | 0 | 0 | 0 | 0 | 0 | 0 | 0 | 0 | 0 | 0 | 0 | 0 | 0 | 0 | 0 |
| BIT NUMBER | 63 | 62 | 61 | 60 | 59 | 58 | 57 | 56 | 55 | 54 | 53 | 52 | 51 | 50 | 49 | 48 |
| RESET STATE | 0 | 0 | 0 | 0 | 0 | 0 | 0 | 0 | 0 | 0 | 0 | 0 | 0 | 0 | 0 | 0 |
| BIT NUMBER | 47 | 46 | 45 | 44 | 43 | 42 | 41 | 40 | 39 | 38 | 37 | 36 | 35 | 34 | 33 | 32 |
| RESET STATE | 0 | 0 | 0 | 0 | 0 | 0 | 0 | 0 | 0 | 0 | 0 | 0 | 0 | 0 | 0 | 0 |
| BIT NUMBER | 31 | 30 | 29 | 28 | 27 | 26 | 25 | 24 | 23 | 22 | 21 | 20 | 19 | 18 | 17 | 16 |
| RESET STATE | 0 | 0 | 0 | 0 | 0 | 0 | 0 | 0 | 0 | 0 | 0 | 0 | 0 | 0 | 0 | 0 |
| BIT NUMBER | 15 | 14 | 13 | 12 | 11 | 10 | 9 | 8 | 7 | 6 | 5 | 4 | 3 | 2 | 1 | 0 |
| RESET STATE | 0 | 0 | 0 | 0 | 0 | 0 | 0 | 0 | 0 | 0 | 0 | 0 | 0 | 0 | 0 | 0 |

Table 5-12. Secondary Header Log Register Description

| BIT | FIELD NAME | ACCESS | DESCRIPTION |
|-----------------------|-------------------|---------------|---|
| 127:64 ⁽¹⁾ | ADDRESS | RU | Transaction address. The 64-bit value transferred on AD[31:0] during the first and second address phases. The first address phase is logged to 95:64 and the second address phase is logged to 127:96. In the case of a 32-bit address, bits 127:96 are set to 0. |
| 63:44 | RSVD | R | Reserved. Returns 0 0000h when read. |
| 43:40 ⁽¹⁾ | UPPER_CMD | RU | Transaction command upper. Contains the status of the C/BE terminals during the second address phase of the PCI transaction that generated the error if using a dual-address cycle. |
| 39:36 ⁽¹⁾ | LOWER_CMD | RU | Transaction command lower. Contains the status of the C/BE terminals during the first address phase of the PCI transaction that generated the error. |
| 35:0 | TRANS_ATTRIBUTE | R | Transaction attribute. Because the bridge does not support the PCI-X attribute transaction phase, these bits have no function, and return 0 0000 0000h when read. |

(1) This register shall only be reset by a Fundamental Reset ($\overline{\text{FRST}}$).

6 Memory-Mapped TI Proprietary Register Space

The programming model of the memory-mapped TI proprietary register space is unique to this device. These custom registers are specifically designed to provide enhanced features associated with upstream isochronous applications.

All bits marked with a 1 are sticky bits and are reset by a fundamental reset ($\overline{\text{FRST}}$).

Table 6-1. Device Control Memory Window Register Map

| REGISTER NAME | | | | OFFSET |
|--|---|--|--------------------------------|---------|
| Reserved | | Revision ID | Device control map ID | 00h |
| Reserved | | | | 04h-3Ch |
| GPIO data ⁽¹⁾ | | GPIO control ⁽¹⁾ | | 40h |
| Serial-bus control and status ⁽¹⁾ | Serial-bus slave address ⁽¹⁾ | Serial-bus word address ⁽¹⁾ | Serial-bus data ⁽¹⁾ | 44h |

(1) This register shall only be reset by a Fundamental Reset ($\overline{\text{FRST}}$).

6.1 Device Control Map ID Register

The device control map ID register identifies the TI proprietary layout for this device control map. The value 04h identifies this as a PCI Express-to-PCI bridge without isochronous capabilities.

Device control memory window register offset: 00h

Register type: Read-only

Default value: 04h

| | | | | | | | | |
|--------------------|----------|----------|----------|----------|----------|----------|----------|----------|
| BIT NUMBER | 7 | 6 | 5 | 4 | 3 | 2 | 1 | 0 |
| RESET STATE | 0 | 0 | 0 | 0 | 0 | 1 | 0 | 0 |

6.2 Revision ID Register

Device control memory window register offset: 01h
Register type: Read-only
Default value: 00h

| BIT NUMBER | 7 | 6 | 5 | 4 | 3 | 2 | 1 | 0 |
|-------------|---|---|---|---|---|---|---|---|
| RESET STATE | 0 | 0 | 0 | 0 | 0 | 0 | 0 | 0 |

6.3 GPIO Control Register

This register controls the direction of the eight GPIO terminals. This register has no effect on the behavior of GPIO terminals that are enabled to perform secondary functions. The secondary functions share GPIO4 (SCL) and GPIO5 (SDA). This register is an alias of the GPIO control register in the classic PCI configuration space(offset B4h, see [Section 4.60](#)). See [Table 6-2](#) for a complete description of the register contents.

Device control memory window register offset: 40h
Register type: Read-only, Read/Write
Default value: 0000h

| BIT NUMBER | 15 | 14 | 13 | 12 | 11 | 10 | 9 | 8 | 7 | 6 | 5 | 4 | 3 | 2 | 1 | 0 |
|-------------|----|----|----|----|----|----|---|---|---|---|---|---|---|---|---|---|
| RESET STATE | 0 | 0 | 0 | 0 | 0 | 0 | 0 | 0 | 0 | 0 | 0 | 0 | 0 | 0 | 0 | 0 |

Table 6-2. GPIO Control Register Description

| BIT | FIELD NAME | ACCESS | DESCRIPTION |
|------------------|------------|--------|--|
| 15:8 | RSVD | R | Reserved. Returns 00h when read. |
| 7 ⁽¹⁾ | GPIO7_DIR | RW | GPIO 7 data direction. This bit selects whether GPIO7 is in input or output mode. 0 = Input (default) 1 = Output |
| 6 ⁽¹⁾ | GPIO6_DIR | RW | GPIO 6 data direction. This bit selects whether GPIO6 is in input or output mode. 0 = Input (default) 1 = Output |
| 5 ⁽¹⁾ | GPIO5_DIR | RW | GPIO 5 data direction. This bit selects whether GPIO5 is in input or output mode. 0 = Input (default) 1 = Output |
| 4 ⁽¹⁾ | GPIO4_DIR | RW | GPIO 4 data direction. This bit selects whether GPIO4 is in input or output mode. 0 = Input (default) 1 = Output |
| 3 ⁽¹⁾ | GPIO3_DIR | RW | GPIO 3 data direction. This bit selects whether GPIO3 is in input or output mode. 0 = Input (default) 1 = Output |
| 2 ⁽¹⁾ | GPIO2_DIR | RW | GPIO 2 data direction. This bit selects whether GPIO2 is in input or output mode. 0 = Input (default) 1 = Output |
| 1 ⁽¹⁾ | GPIO1_DIR | RW | GPIO 1 data direction. This bit selects whether GPIO1 is in input or output mode. 0 = Input (default) 1 = Output |
| 0 ⁽¹⁾ | GPIO0_DIR | RW | GPIO 0 data direction. This bit selects whether GPIO0 is in input or output mode. 0 = Input (default) 1 = Output |

(1) This register shall only be reset by a Fundamental Reset ($\overline{\text{FRST}}$).

6.4 GPIO Data Register

This register reads the state of the input mode GPIO terminals and changes the state of the output mode GPIO terminals. Writing to a bit that is in input mode or is enabled for a secondary function is ignored. The secondary functions share GPIO4 (SCL) and GPIO5 (SDA). The default value at power up depends on the state of the GPIO terminals as they default to general-purpose inputs. This register is an alias of the GPIO data register in the classic PCI configuration space (offset B6h, see [Section 4.61](#)). See [Table 6-3](#) for a complete description of the register contents.

Device control memory window register offset: 42h
 Register type: Read-only, Read/Write
 Default value: 00XXh

| BIT NUMBER | 15 | 14 | 13 | 12 | 11 | 10 | 9 | 8 | 7 | 6 | 5 | 4 | 3 | 2 | 1 | 0 |
|-------------|----|----|----|----|----|----|---|---|---|---|---|---|---|---|---|---|
| RESET STATE | 0 | 0 | 0 | 0 | 0 | 0 | 0 | 0 | x | x | x | x | x | x | x | x |

Table 6-3. GPIO Data Register Description

| BIT | FIELD NAME | ACCESS | DESCRIPTION |
|------------------|------------|--------|--|
| 15:8 | RSVD | R | Reserved |
| 7 ⁽¹⁾ | GPIO7_Data | RW | GPIO 7 data. This bit reads the state of GPIO7 when in input mode or changes the state of GPIO7 when in output mode. |
| 6 ⁽¹⁾ | GPIO6_Data | RW | GPIO 6 data. This bit reads the state of GPIO6 when in input mode or changes the state of GPIO6 when in output mode. |
| 5 ⁽¹⁾ | GPIO5_Data | RW | GPIO 5 data. This bit reads the state of GPIO5 when in input mode or changes the state of GPIO5 when in output mode. |
| 4 ⁽¹⁾ | GPIO4_Data | RW | GPIO 4 data. This bit reads the state of GPIO4 when in input mode or changes the state of GPIO4 when in output mode. |
| 3 ⁽¹⁾ | GPIO3_Data | RW | GPIO 3 data. This bit reads the state of GPIO3 when in input mode or changes the state of GPIO3 when in output mode. |
| 2 ⁽¹⁾ | GPIO2_Data | RW | GPIO 2 data. This bit reads the state of GPIO2 when in input mode or changes the state of GPIO2 when in output mode. |
| 1 ⁽¹⁾ | GPIO1_Data | RW | GPIO 1 data. This bit reads the state of GPIO1 when in input mode or changes the state of GPIO1 when in output mode. |
| 0 ⁽¹⁾ | GPIO0_Data | RW | GPIO 0 data. This bit reads the state of GPIO0 when in input mode or changes the state of GPIO0 when in output mode. |

(1) This register shall only be reset by a Fundamental Reset ($\overline{\text{FRST}}$).

6.5 Serial-Bus Data Register

The Serial Bus Data register is used to read and write data on the serial bus interface. When writing data to the serial bus, this register must be written before writing to the Serial Bus Address register to initiate the cycle. When reading data from the serial bus, this register will contain the data read after the REQBUSY (bit 5 Serial Bus Control Register) bit is cleared. This register is an alias for the Serial Bus Data register in the PCI header. This register shall only be reset by a Fundamental Reset ($\overline{\text{FRST}}$).

Device control memory window register offset: 44h
 Register type: Read/Write
 Default value: 00h

| BIT NUMBER | 7 | 6 | 5 | 4 | 3 | 2 | 1 | 0 |
|-------------|---|---|---|---|---|---|---|---|
| RESET STATE | 0 | 0 | 0 | 0 | 0 | 0 | 0 | 1 |

6.6 Serial-Bus Word Address Register

The value written to the Serial Bus Index register represents the byte address of the byte being read or written from the serial bus device. The Serial Bus Index register must be written before the before initiating a serial bus cycle by writing to the Serial Bus Slave Address register. This register is an alias for the Serial Bus Index register in the PCI header. This register shall only be reset by a Fundamental Reset ($\overline{\text{FRST}}$).

Device control memory window register offset: 45h
 Register type: Read/Write
 Default value: 00h

| BIT NUMBER | 7 | 6 | 5 | 4 | 3 | 2 | 1 | 0 |
|-------------|---|---|---|---|---|---|---|---|
| RESET STATE | 0 | 0 | 0 | 0 | 0 | 0 | 0 | 0 |

6.7 Serial-Bus Slave Address Register

The Serial Bus Slave Address register is used to indicate the address of the device being targeted by the serial bus cycle. This register also indicates if the cycle will be a read or a write cycle. Writing to this register initiates the cycle on the serial interface. This register is an alias for the Serial Bus Slave Address register in the PCI header.

Device control memory window register offset: 46h
 Register type: Read/Write
 Default value: 00h

| BIT NUMBER | 7 | 6 | 5 | 4 | 3 | 2 | 1 | 0 |
|-------------|---|---|---|---|---|---|---|---|
| RESET STATE | 0 | 0 | 0 | 0 | 0 | 0 | 0 | 0 |

Table 6-4. Serial-Bus Slave Address Register Descriptions

| BIT | FIELD NAME | ACCESS | DESCRIPTION |
|--------------------|------------|--------|--|
| 7:1 ⁽¹⁾ | SLAVE_ADDR | RW | Serial-bus slave address. This 7-bit field is the slave address for a serial-bus read or write transaction. The default value for this field is 000 0000b. |
| 0 ⁽¹⁾ | RW_CMD | RW | Read/write command. This bit determines if the serial-bus cycle is a read or a write cycle. 0 = A single byte write is requested (default) 1 = A single byte read is requested |

(1) This register shall only be reset by a Fundamental Reset ($\overline{\text{FRST}}$).

6.8 Serial-Bus Control and Status Register

The Serial Bus Control and Status register is used to control the behavior of the Serial bus interface. This register also provides status information about the state of the serial bus. This register is an alias for the Serial Bus Control and Status register in the PCI header.

Device control memory window register offset: 47h
 Register type: Read-only, Read/Write, Read/Clear
 Default value: 00h

| BIT NUMBER | 7 | 6 | 5 | 4 | 3 | 2 | 1 | 0 |
|-------------|---|---|---|---|---|---|---|---|
| RESET STATE | 0 | 0 | 0 | 0 | 0 | 0 | 0 | 0 |

Table 6-5. Serial-Bus Control and Status Register Description

| BIT | FIELD NAME | ACCESS | DESCRIPTION |
|------------------|------------|--------|---|
| 7 ⁽¹⁾ | PROT_SEL | RW | Protocol select. This bit selects the serial-bus address mode used. 0 = Slave address and word address are sent on the serial-bus (default) 1 = Only the slave address is sent on the serial-bus |
| 6 | RSVD | R | Reserved. Returns 0b when read. |
| 5 ⁽¹⁾ | REQBUSY | RU | Requested serial-bus access busy. This bit is set when a software-initiated serial-bus cycle is in progress. 0 = No serial-bus cycle 1 = Serial-bus cycle in progress |
| 4 ⁽¹⁾ | ROMBUSY | RU | Serial EEPROM access busy. This bit is set when the serial EEPROM circuitry in the bridge is downloading register defaults from a serial EEPROM. 0 = No EEPROM activity 1 = EEPROM download in progress |
| 3 ⁽¹⁾ | SBDETECT | RWU | Serial EEPROM detected. This bit enables the serial-bus interface. The value of this bit controls whether the GPIO4//SCL and GPIO5//SDA terminals are configured as GPIO signals or as serial-bus signals. This bit is automatically set to 1b when a serial EEPROM is detected. Note: A serial EEPROM is only detected once following $\overline{\text{PERST}}$. 0 = No EEPROM present, EEPROM load process does not happen. GPIO4//SCL and GPIO5//SDA terminals are configured as GPIO signals. 1 = EEPROM present, EEPROM load process takes place. GPIO4//SCL and GPIO5//SDA terminals are configured as serial-bus signals. |
| 2 ⁽¹⁾ | SBTEST | RW | Serial-bus test. This bit is used for internal test purposes. This bit controls the clock source for the serial interface clock. 0 = Serial-bus clock at normal operating frequency ~ 60 kHz (default) 1 = Serial-bus clock frequency increased for test purposes ~ 4 MHz |
| 1 ⁽¹⁾ | SB_ERR | RCU | Serial-bus error. This bit is set when an error occurs during a software-initiated serial-bus cycle. 0 = No error 1 = Serial-bus error |
| 0 ⁽¹⁾ | ROM_ERR | RCU | Serial EEPROM load error. This bit is set when an error occurs while downloading registers from a serial EEPROM. 0 = No error 1 = EEPROM load error |

(1) This register shall only be reset by a Fundamental Reset ($\overline{\text{FRST}}$).

7 1394 OHCI—PCI Configuration Space

The 1394 OHCI core is integrated as a PCI device behind the PCI-Express to PCI Bridge. The configuration header for the 1394b OHCI portion of the design is compliant with the PCI Specification as a standard header. [Table 7-1](#) illustrates the configuration header that includes both the predefined portion of the configuration space and the user definable registers.

Since the 1394 OHCI configuration space is accessed over the bridge secondary PCI bus, PCI Express type 1 configuration read and write transactions are required when accessing these registers. The 1394 OHCI configuration register map is accessed as device number 0 and function number 0. Of course, the bus number is determined by the value that is loaded into the Secondary Bus Number field at offset 19h within the PCI Express configuration register map.

All bits marked with a ‡ are reset by a Fundamental Reset ($\overline{\text{FRST}}$). The remaining register bits are reset by a PCI Express hot reset, $\overline{\text{PERST}}$, or a Fundamental Reset ($\overline{\text{FRST}}$).

Table 7-1. 1394 OHCI Configuration Register Map

| REGISTER NAME | | | | OFFSET |
|--|------------------------------|--|---|---------|
| Device ID | | Vendor ID | | 00h |
| Status | | Command | | 04h |
| Class code | | Revision ID | | 08h |
| BIST | Header type | Latency timer | Cache line size | 0Ch |
| OHCI base address | | | | 10h |
| TI extension base address | | | | 14h |
| CIS base address | | | | 18h |
| Reserved | | | | 1Ch-27h |
| CIS pointer | | | | 28h |
| Subsystem ID ⁽¹⁾ | | Subsystem vendor ID ⁽¹⁾ | | 2Ch |
| Reserved | | | | 30h |
| Reserved | | | PCI power management capabilities pointer | 34h |
| Reserved | | | | 38h |
| Maximum latency ⁽¹⁾ | Minimum grant ⁽¹⁾ | Interrupt pin | Interrupt line | 3Ch |
| PCI OHCI control | | | | 40h |
| Power management capabilities | | Next item pointer | Capability ID | 44h |
| PM data (RSVD) | PMCSR_BSE | Power management control and status ⁽¹⁾ | | 48h |
| Reserved | | | | 4Ch-E7h |
| Multifunction Select Register | | | | E8h |
| PCI PHY control ⁽¹⁾ | | | | ECh |
| Miscellaneous configuration ⁽¹⁾ | | | | F0h |
| Link enhancement control ⁽¹⁾ | | | | F4h |
| Subsystem access ⁽¹⁾ | | | | F8h |
| TI proprietary | | | | FCh |

(1) This register shall only be reset by a Fundamental Reset ($\overline{\text{FRST}}$).

7.1 Vendor ID Register

The vendor ID register contains a value allocated by the PCI SIG and identifies the manufacturer of the OHCI controller. The vendor ID assigned to Texas Instruments is 104Ch.

PCI register offset: 00h

Register type: Read-only

Default value: 104Ch

| BIT NUMBER | 15 | 14 | 13 | 12 | 11 | 10 | 9 | 8 | 7 | 6 | 5 | 4 | 3 | 2 | 1 | 0 |
|-------------|----|----|----|----|----|----|---|---|---|---|---|---|---|---|---|---|
| RESET STATE | 0 | 0 | 0 | 1 | 0 | 0 | 0 | 0 | 0 | 1 | 0 | 0 | 1 | 1 | 0 | 0 |

7.2 Device ID Register

The device ID register contains a value assigned to the 1394 OHCI function by Texas Instruments. The device identification for the 1394 OHCI function is 823Fh.

PCI register offset: 02h

Register type: Read-only

Default value: 823Fh

| BIT NUMBER | 15 | 14 | 13 | 12 | 11 | 10 | 9 | 8 | 7 | 6 | 5 | 4 | 3 | 2 | 1 | 0 |
|-------------|----|----|----|----|----|----|---|---|---|---|---|---|---|---|---|---|
| RESET STATE | 1 | 0 | 0 | 0 | 0 | 0 | 1 | 0 | 0 | 0 | 1 | 1 | 1 | 1 | 1 | 1 |

7.3 Command Register

The command register provides control over the 1394b OHCI function interface to the PCI bus. All bit functions adhere to the definitions in the PCI Local Bus Specification, as seen in the following bit descriptions. See [Table 7-2](#) for a complete description of the register contents.

PCI register offset: 04h

Register type: Read/Write, Read-only

Default value: 0000h

| BIT NUMBER | 15 | 14 | 13 | 12 | 11 | 10 | 9 | 8 | 7 | 6 | 5 | 4 | 3 | 2 | 1 | 0 |
|-------------|----|----|----|----|----|----|---|---|---|---|---|---|---|---|---|---|
| RESET STATE | 0 | 0 | 0 | 0 | 0 | 0 | 0 | 0 | 0 | 0 | 0 | 0 | 0 | 0 | 0 | 0 |

Table 7-2. Command Register Description

| BIT | FIELD NAME | TYPE | DESCRIPTION |
|-------|-------------|------|---|
| 15-11 | RSVD | R | Reserved. Bits 15-11 return 0 0000b when read. |
| 10 | INT_DISABLE | R | Interrupt disable. When bit 10 is set to 1b, the OHCI controller is disabled from asserting an interrupt. When cleared, the OHCI controller is able to send interrupts normally. This default value for this bit is 0b. |
| 9 | FBB_ENB | R | Fast back-to-back enable. The 1394b OHCI controller does not generate fast back-to-back transactions; therefore, bit 9 returns 0b when read. |
| 8 | SERR_ENB | RW | PCI_SERR enable. When bit 8 is set to 1b, the 1394b OHCI controller PCI_SERR driver is enabled. PCI_SERR can be asserted after detecting an address parity error on the PCI bus. The default value for this bit is 0b. |
| 7 | STEP_ENB | R | Address/data stepping control. The 1394b OHCI controller does not support address/data stepping; therefore, bit 7 is hardwired to 0b. |
| 6 | PERR_ENB | RW | Parity error enable. When bit 6 is set to 1b, the 1394b OHCI controller is enabled to drive PCI_PERR response to parity errors through the PCI_PERR signal. The default value for this bit is 0b. |
| 5 | VGA_ENB | R | VGA palette snoop enable. The 1394b OHCI controller does not feature VGA palette snooping; therefore, bit 5 returns 0b when read. |
| 4 | MWI_ENB | RW | Memory write and invalidate enable. When bit 4 is set to 1b, the OHCI controller is enabled to generate MWI PCI bus commands. If this bit is cleared, then the 1394b OHCI controller generates memory write commands instead. The default value for this bit is 0b. |

Table 7-2. Command Register Description (continued)

| BIT | FIELD NAME | TYPE | DESCRIPTION |
|-----|------------|------|--|
| 3 | SPECIAL | R | Special cycle enable. The 1394b OHCI controller function does not respond to special cycle transactions; therefore, bit 3 returns 0b when read. |
| 2 | MASTER_ENB | RW | Bus master enable. When bit 2 is set to 1b, the 1394b OHCI controller is enabled to initiate cycles on the PCI bus. The default value for this bit is 0b. |
| 1 | MEMORY_ENB | RW | Memory response enable. Setting bit 1 to 1b enables the 1394b OHCI controller to respond to memory cycles on the PCI bus. This bit must be set to access OHCI registers. The default value for this bit is 0b. |
| 0 | IO_ENB | R | I/O space enable. The 1394b OHCI controller does not implement any I/O-mapped functionality; therefore, bit 0 returns 0b when read. |

7.4 Status Register

The status register provides status over the 1394b OHCI controller interface to the PCI bus. All bit functions adhere to the definitions in the *PCI Local Bus Specification*, as seen in the following bit descriptions. See [Table 7-3](#) for a complete description of the register contents.

PCI register offset: 06h
Register type: Read/Clear/Update, Read-only
Default value: 0230h

| BIT NUMBER | 15 | 14 | 13 | 12 | 11 | 10 | 9 | 8 | 7 | 6 | 5 | 4 | 3 | 2 | 1 | 0 |
|-------------|----|----|----|----|----|----|---|---|---|---|---|---|---|---|---|---|
| RESET STATE | 0 | 0 | 0 | 0 | 0 | 0 | 1 | 0 | 0 | 0 | 1 | 1 | 0 | 0 | 0 | 0 |

Table 7-3. Status Register Description

| BIT | FIELD NAME | TYPE | DESCRIPTION |
|------|------------|------|---|
| 15 | PAR_ERR | RCU | Detected parity error. Bit 15 is set to 1b when either an address parity or data parity error is detected. |
| 14 | SYS_ERR | RCU | Signaled system error. Bit 14 is set to 1b when PCI_SERR is enabled and the 1394b OHCI controller has signaled a system error to the host. |
| 13 | MABORT | RCU | Received master abort. Bit 13 is set to 1b when a cycle initiated by the 1394b OHCI controller on the PCI bus has been terminated by a master abort. |
| 12 | TABORT_REC | RCU | Received target abort. Bit 12 is set to 1b when a cycle initiated by the 1394b OHCI controller on the PCI bus was terminated by a target abort. |
| 11 | TABORT_SIG | RCU | Signaled target abort. Bit 11 is set to 1b by the 1394b OHCI controller when it terminates a transaction on the PCI bus with a target abort. |
| 10-9 | PCI_SPEEDO | R | DEVSEL timing. Bits 10 and 9 encode the timing of PCI_DEVSEL and are hardwired to 01b, indicating that the 1394b OHCI controller asserts this signal at a medium speed on nonconfiguration cycle accesses. |
| 8 | DATAPAR | RCU | Data parity error detected. Bit 8 is set to 1b when the following conditions have been met: a. PCI_PERR was asserted by any PCI device including the OHCI controller. b. The 1394b OHCI controller was the bus master during the data parity error. c. Bit 6 (PERR_EN) in the command register at offset 04h in the PCI configuration space (see Section 7.3 , Command Register) is set to 1b. |
| 7 | FBB_CAP | R | Fast back-to-back capable. The 1394b OHCI controller cannot accept fast back-to-back transactions; therefore, bit 7 is hardwired to 0b. |
| 6 | UDF | R | User-definable features (UDF) supported. The 1394b OHCI controller does not support the UDF; therefore, bit 6 is hardwired to 0b. |
| 5 | 66MHZ | R | 66-MHz capable. The 1394b OHCI controller operates at a maximum PCI_CLK frequency of 66 MHz; therefore, bit 5 is hardwired to 1b. |
| 4 | CAPLIST | R | Capabilities list. Bit 4 returns 1b when read, indicating that capabilities additional to standard PCI are implemented. The linked list of PCI power-management capabilities is implemented in this function. |

Table 7-3. Status Register Description (continued)

| BIT | FIELD NAME | TYPE | DESCRIPTION |
|-----|------------|------|---|
| 3 | INT_STATUS | RU | Interrupt status. This bit reflects the interrupt status of the function. Only when bit 10 (INT_DISABLE) in the command register (PCI offset 04h, see Section 4.3) is a 0 and this bit is a 1, is the function's INTx signal asserted. Setting the INT_DISABLE bit to a 1 has no effect on the state of this bit. This bit has been defined as part of the PCI Local Bus Specification (Revision 2.3). |
| 2-0 | RSVD | R | Reserved. Bits 3-0 return 0h when read. |

7.5 Class Code and Revision ID Register

The class code and revision ID register categorizes the 1394b OHCI controller as a serial bus controller (0Ch), controlling an IEEE 1394 bus (00h), with an OHCI programming model (10h). Furthermore, the TI chip revision is indicated in the least significant byte. See [Table 7-4](#) for a complete description of the register contents.

PCI register offset: 08h
 Register type: Read-only
 Default value: 0C00 1001h

| BIT NUMBER | 31 | 30 | 29 | 28 | 27 | 26 | 25 | 24 | 23 | 22 | 21 | 20 | 19 | 18 | 17 | 16 |
|-------------|----|----|----|----|----|----|----|----|----|----|----|----|----|----|----|----|
| RESET STATE | 0 | 0 | 0 | 1 | 1 | 0 | 0 | 0 | 0 | 0 | 0 | 0 | 0 | 0 | 0 | 0 |

| BIT NUMBER | 15 | 14 | 13 | 12 | 11 | 10 | 9 | 8 | 7 | 6 | 5 | 4 | 3 | 2 | 1 | 0 |
|-------------|----|----|----|----|----|----|---|---|---|---|---|---|---|---|---|---|
| RESET STATE | 0 | 0 | 0 | 1 | 0 | 0 | 0 | 0 | 0 | 0 | 0 | 0 | 0 | 0 | 0 | 1 |

Table 7-4. Class Code and Revision ID Register Description

| BIT | FIELD NAME | ACCESS | DESCRIPTION |
|-------|------------|--------|--|
| 31-24 | BASECLASS | R | Base class. This field returns 0Ch when read, which broadly classifies the function as a serial bus controller. |
| 23-16 | SUBCLASS | R | Subclass. This field returns 00h when read, which specifically classifies the function as controlling an IEEE 1394 serial bus. |
| 15-8 | PGMIF | R | Programming interface. This field returns 10h when read, which indicates that the programming model is compliant with the 1394 Open Host Controller Interface Specification. |
| 7-0 | CHIPREV | R | Silicon revision. This field returns 00h when read, which indicates the silicon revision of the 1394b OHCI controller. |

7.6 Cache Line Size and Latency Timer Register

The latency timer and class cache line size register is programmed by host BIOS to indicate system cache line size and the latency timer associated with the 1394b OHCI controller. See [Table 7-5](#) for a complete description of the register contents.

PCI register offset: 0Ch
 Register type: Read/Write
 Default value: 0000h

| BIT NUMBER | 15 | 14 | 13 | 12 | 11 | 10 | 9 | 8 | 7 | 6 | 5 | 4 | 3 | 2 | 1 | 0 |
|-------------|----|----|----|----|----|----|---|---|---|---|---|---|---|---|---|---|
| RESET STATE | 0 | 0 | 0 | 0 | 0 | 0 | 0 | 0 | 0 | 0 | 0 | 0 | 0 | 0 | 0 | 0 |

Table 7-5. Latency Timer and Class Cache Line Size Register Description

| BIT | FIELD NAME | ACCESS | DESCRIPTION |
|------|---------------|--------|--|
| 15-8 | LATENCY_TIMER | RW | PCI latency timer. The value in this register specifies the latency timer for the 1394b OHCI controller, in units of PCI clock cycles. When the 1394b OHCI function is a PCI bus initiator and asserts PCI_FRAME, the latency timer begins counting from zero. If the latency timer expires before the 1394b OHCI function's transaction has terminated, then the 1394b OHCI function terminates the transaction when its PCI_GNT is deasserted. |
| 7-0 | CACHELINE_SZ | RW | Cache line size. This value is used by the OHCI controller during memory write and invalidate, memory-read line, and memory-read multiple transactions. The default value for this field is 00h. |

7.7 Header Type and BIST Register

The header type and built-in self-test (BIST) register indicates the OHCI controller PCI header type and no built-in self-test. See [Table 7-6](#) for a complete description of the register contents.

PCI register offset: 0Eh
Register type: Read-only
Default value: 0000h

| BIT NUMBER | 15 | 14 | 13 | 12 | 11 | 10 | 9 | 8 | 7 | 6 | 5 | 4 | 3 | 2 | 1 | 0 |
|-------------|----|----|----|----|----|----|---|---|---|---|---|---|---|---|---|---|
| RESET STATE | 0 | 0 | 0 | 0 | 0 | 0 | 0 | 0 | 0 | 0 | 0 | 0 | 0 | 0 | 0 | 0 |

Table 7-6. Header Type and BIST Register Description

| BIT | FIELD NAME | TYPE | DESCRIPTION |
|------|-------------|------|---|
| 15-8 | BIST | R | Built-in self-test. The OHCI controller does not include a BIST; therefore, this field returns 00h when read. |
| 7-0 | HEADER_TYPE | R | PCI header type. The OHCI controller includes the standard PCI header, which is communicated by returning 00h when this field is read. Since the 1394b OHCI core is implemented as a single function PCI device, bit 7 of this register must be 0b. |

7.8 OHCI Base Address Register

The OHCI base address register is programmed with a base address referencing the memory-mapped OHCI control. When BIOS writes all 1s to this register, the value read back is FFFF F800h, indicating that at least 2K bytes of memory address space are required for the OHCI registers. See [Table 7-7](#) for a complete description of the register contents.

PCI register offset: 10h
Register type: Read/Write, Read-only
Default value: 0000 0000h

| BIT NUMBER | 31 | 30 | 29 | 28 | 27 | 26 | 25 | 24 | 23 | 22 | 21 | 20 | 19 | 18 | 17 | 16 |
|-------------|----|----|----|----|----|----|----|----|----|----|----|----|----|----|----|----|
| RESET STATE | 0 | 0 | 0 | 0 | 0 | 0 | 0 | 0 | 0 | 0 | 0 | 0 | 0 | 0 | 0 | 0 |

| BIT NUMBER | 15 | 14 | 13 | 12 | 11 | 10 | 9 | 8 | 7 | 6 | 5 | 4 | 3 | 2 | 1 | 0 |
|-------------|----|----|----|----|----|----|---|---|---|---|---|---|---|---|---|---|
| RESET STATE | 0 | 0 | 0 | 0 | 0 | 0 | 0 | 0 | 0 | 0 | 0 | 0 | 0 | 0 | 0 | 0 |

Table 7-7. OHCI Base Address Register Description

| BIT | FIELD NAME | TYPE | DESCRIPTION |
|-------|--------------|------|---|
| 31-11 | OHCIREG_PTR | RW | OHCI register pointer. This field specifies the upper 21 bits of the 32-bit OHCI base address register. The default value for this field is all 0s. |
| 10-4 | OHCI_SZ | R | OHCI register size. This field returns 000 0000b when read, indicating that the OHCI registers require a 2K-byte region of memory. |
| 3 | OHCI_PF | R | OHCI register prefetch. Bit 3 returns 0b when read, indicating that the OHCI registers are nonprefetchable. |
| 2-1 | OHCI_MEMTYPE | R | OHCI memory type. This field returns 00b when read, indicating that the OHCI base address register is 32 bits wide and mapping can be done anywhere in the 32-bit memory space. |
| 0 | OHCI_MEM | R | OHCI memory indicator. Bit 0 returns 0b when read, indicating that the OHCI registers are mapped into system memory space. |

7.9 TI Extension Base Address Register

The TI extension base address register is programmed with a base address referencing the memory-mapped TI extension registers. When BIOS writes all 1s to this register, the value read back is FFFF C000h, indicating that at least 16K bytes of memory address space are required for the TI registers. See [Table 7-8](#) for a complete description of the register contents.

PCI register offset: 14h
 Register type: Read/Write, Read-only
 Default value: 0000 0000h

| BIT NUMBER | 31 | 30 | 29 | 28 | 27 | 26 | 25 | 24 | 23 | 22 | 21 | 20 | 19 | 18 | 17 | 16 |
|-------------|----|----|----|----|----|----|----|----|----|----|----|----|----|----|----|----|
| RESET STATE | 0 | 0 | 0 | 0 | 0 | 0 | 0 | 0 | 0 | 0 | 0 | 0 | 0 | 0 | 0 | 0 |

| BIT NUMBER | 15 | 14 | 13 | 12 | 11 | 10 | 9 | 8 | 7 | 6 | 5 | 4 | 3 | 2 | 1 | 0 |
|-------------|----|----|----|----|----|----|---|---|---|---|---|---|---|---|---|---|
| RESET STATE | 0 | 0 | 0 | 0 | 0 | 0 | 0 | 0 | 0 | 0 | 0 | 0 | 0 | 0 | 0 | 0 |

Table 7-8. TI Base Address Register Description

| BIT | FIELD NAME | TYPE | DESCRIPTION |
|-------|------------|------|---|
| 31-14 | TIREG_PTR | RW | TI register pointer. This field specifies the upper 18 bits of the 32-bit TI base address register. The default value for this field is all 0s. |
| 13-4 | TI_SZ | R | TI register size. This field returns 00 0000 0000b when read, indicating that the TI registers require a 16K-byte region of memory. |
| 3 | TI_PF | R | TI register prefetch. Bit 3 returns 0b when read, indicating that the TI registers are nonprefetchable. |
| 2-1 | TI_MEMTYPE | R | TI memory type. This field returns 00b when read, indicating that the TI base address register is 32 bits wide and mapping can be done anywhere in the 32-bit memory space. |
| 0 | TI_MEM | R | TI memory indicator. Bit 0 returns 0b when read, indicating that the TI registers are mapped into system memory space. |

7.10 CIS Base Address Register

The $\overline{\text{CARDBUS}}$ input to the 1394 OHCI core is tied high such that this register returns 0000 0000h when read.

PCI register offset: 18h
Register type: Read-only
Default value: 0000 0000h

| | | | | | | | | | | | | | | | | |
|--------------------|----|----|----|----|----|----|----|----|----|----|----|----|----|----|----|----|
| BIT NUMBER | 31 | 30 | 29 | 28 | 27 | 26 | 25 | 24 | 23 | 22 | 21 | 20 | 19 | 18 | 17 | 16 |
| RESET STATE | 0 | 0 | 0 | 0 | 0 | 0 | 0 | 0 | 0 | 0 | 0 | 0 | 0 | 0 | 0 | 0 |
| BIT NUMBER | 15 | 14 | 13 | 12 | 11 | 10 | 9 | 8 | 7 | 6 | 5 | 4 | 3 | 2 | 1 | 0 |
| RESET STATE | 0 | 0 | 0 | 0 | 0 | 0 | 0 | 0 | 0 | 0 | 0 | 0 | 0 | 0 | 0 | 0 |

7.11 CIS Pointer Register

The $\overline{\text{CARDBUS}}$ input to the 1394 OHCI core is tied high such that this register returns 0000 0000h when read.

PCI register offset: 28h
Register type: Read-only
Default value: 0000 0000h

| | | | | | | | | | | | | | | | | |
|--------------------|----|----|----|----|----|----|----|----|----|----|----|----|----|----|----|----|
| BIT NUMBER | 31 | 30 | 29 | 28 | 27 | 26 | 25 | 24 | 23 | 22 | 21 | 20 | 19 | 18 | 17 | 16 |
| RESET STATE | 0 | 0 | 0 | 0 | 0 | 0 | 0 | 0 | 0 | 0 | 0 | 0 | 0 | 0 | 0 | 0 |
| BIT NUMBER | 15 | 14 | 13 | 12 | 11 | 10 | 9 | 8 | 7 | 6 | 5 | 4 | 3 | 2 | 1 | 0 |
| RESET STATE | 0 | 0 | 0 | 0 | 0 | 0 | 0 | 0 | 0 | 0 | 0 | 0 | 0 | 0 | 0 | 0 |

7.12 Subsystem Identification Register

The subsystem identification register is used for system and option card identification purposes. This register can be initialized from the serial EEPROM or programmed via the subsystem access register at offset F8h in the PCI configuration space (see [Section 7.23](#)). See [Table 7-9](#) for a complete description of the register contents.

PCI register offset: 2Ch
Register type: Read/Update
Default value: 0000 0000h

| | | | | | | | | | | | | | | | | |
|--------------------|----|----|----|----|----|----|----|----|----|----|----|----|----|----|----|----|
| BIT NUMBER | 31 | 30 | 29 | 28 | 27 | 26 | 25 | 24 | 23 | 22 | 21 | 20 | 19 | 18 | 17 | 16 |
| RESET STATE | 0 | 0 | 0 | 0 | 0 | 0 | 0 | 0 | 0 | 0 | 0 | 0 | 0 | 0 | 0 | 0 |
| BIT NUMBER | 15 | 14 | 13 | 12 | 11 | 10 | 9 | 8 | 7 | 6 | 5 | 4 | 3 | 2 | 1 | 0 |
| RESET STATE | 0 | 0 | 0 | 0 | 0 | 0 | 0 | 0 | 0 | 0 | 0 | 0 | 0 | 0 | 0 | 0 |

Table 7-9. Subsystem Identification Register Description

| BIT | FIELD NAME | TYPE | DESCRIPTION |
|----------------------|------------|------|--|
| 31-16 ⁽¹⁾ | OHCI_SSID | RU | Subsystem device ID. This field indicates the subsystem device ID. |
| 15-0 ⁽¹⁾ | OHCI_SSVID | RU | Subsystem vendor ID. This field indicates the subsystem vendor ID. |

(1) These bits are reset by a PCI Express reset ($\overline{\text{PERST}}$), or by a Fundamental Reset ($\overline{\text{FRST}}$).

7.13 Power Management Capabilities Pointer Register

The power management capabilities pointer register provides a pointer into the PCI configuration header where the power-management register block resides. The OHCI controller configuration header doublewords at offsets 44h and 48h provide the power-management registers. This register is read-only and returns 44h when read.

PCI register offset: 34h
 Register type: Read-only
 Default value: 44h

| BIT NUMBER | 7 | 6 | 5 | 4 | 3 | 2 | 1 | 0 |
|-------------|---|---|---|---|---|---|---|---|
| RESET STATE | 0 | 1 | 0 | 0 | 0 | 1 | 0 | 0 |

7.14 Interrupt Line and Pin Register

The interrupt line and pin register communicates interrupt line routing information. See [Table 7-10](#) for a complete description of the register contents.

PCI register offset: 3Ch
 Register type: Read/Write
 Default value: 01FFh

| BIT NUMBER | 15 | 14 | 13 | 12 | 11 | 10 | 9 | 8 | 7 | 6 | 5 | 4 | 3 | 2 | 1 | 0 |
|-------------|----|----|----|----|----|----|---|---|---|---|---|---|---|---|---|---|
| RESET STATE | 0 | 0 | 0 | 0 | 0 | 0 | 0 | 1 | 1 | 1 | 1 | 1 | 1 | 1 | 1 | 1 |

Table 7-10. Interrupt Line and Pin Registers Description

| BIT | FIELD NAME | TYPE | DESCRIPTION |
|------|------------|------|---|
| 15-8 | INTR_PIN | R | Interrupt pin. This field returns 01h when read, indicating that the 1394 OHCI core signals interrupts on the INTA terminal. |
| 7-0 | INTR_LINE | RW | Interrupt line. This field is programmed by the system and indicates to software which interrupt line the OHCI controller INTA is connected to. The default value for this field is all FFh, indicating that an interrupt line has not yet been assigned to the function. |

7.15 MIN_GNT and MAX_LAT Register

The MIN_GNT and MAX_LAT register communicates to the system the desired setting of bits 15-8 in the latency timer and class cache line size register at offset 0Ch in the PCI configuration space (see [Section 7.6](#)). If a serial EEPROM is detected, then the contents of this register are loaded through the serial EEPROM interface. If no serial EEPROM is detected, then this register returns a default value that corresponds to the MAX_LAT = 4, MIN_GNT = 2. See [Table 7-11](#) for a complete description of the register contents.

PCI register offset: 3Eh
 Register type: Read/Update
 Default value: 0402h

| BIT NUMBER | 15 | 14 | 13 | 12 | 11 | 10 | 9 | 8 | 7 | 6 | 5 | 4 | 3 | 2 | 1 | 0 |
|-------------|----|----|----|----|----|----|---|---|---|---|---|---|---|---|---|---|
| RESET STATE | 0 | 0 | 0 | 0 | 0 | 1 | 0 | 0 | 0 | 0 | 0 | 0 | 0 | 0 | 1 | 0 |

Table 7-11. MIN_GNT and MAX_LAT Register Description

| BIT | FIELD NAME | TYPE | DESCRIPTION |
|---------------------|------------|------|--|
| 15-8 ⁽¹⁾ | MAX_LAT | RU | Maximum latency. The contents of this field may be used by host BIOS to assign an arbitration priority level to the OHCI controller. The default for this register indicates that the OHCI controller may need to access the PCI bus as often as every 0.25 μ s; thus, an extremely high priority level is requested. Bits 11-8 of this field may also be loaded through the serial EEPROM. |
| 7-0 ⁽¹⁾ | MIN_GNT | RU | Minimum grant. The contents of this field may be used by host BIOS to assign a latency timer register value to the OHCI controller. The default for this register indicates that the OHCI controller may need to sustain burst transfers for nearly 64 μ s and thus request a large value be programmed in bits 15-8 of the OHCI controller latency timer and class cache line size register at offset 0Ch in the PCI configuration space (see Section 7.6). Bits 3-0 of this field may also be loaded through the serial EEPROM. |

(1) These bits are reset by a PCI Express reset ($\overline{\text{PERST}}$), or by a Fundamental Reset ($\overline{\text{FRST}}$).

7.16 OHCI Control Register

The PCI OHCI control register is defined by the 1394 Open Host Controller Interface Specification and provides a bit for big endian PCI support. See [Table 7-12](#) for a complete description of the register contents.

PCI register offset: 40h
Register type: Read/Write, Read-only
Default value: 0000 0000h

| BIT NUMBER | 31 | 30 | 29 | 28 | 27 | 26 | 25 | 24 | 23 | 22 | 21 | 20 | 19 | 18 | 17 | 16 |
|-------------|----|----|----|----|----|----|----|----|----|----|----|----|----|----|----|----|
| RESET STATE | 0 | 0 | 0 | 0 | 0 | 0 | 0 | 0 | 0 | 0 | 0 | 0 | 0 | 0 | 0 | 0 |

| BIT NUMBER | 15 | 14 | 13 | 12 | 11 | 10 | 9 | 8 | 7 | 6 | 5 | 4 | 3 | 2 | 1 | 0 |
|-------------|----|----|----|----|----|----|---|---|---|---|---|---|---|---|---|---|
| RESET STATE | 0 | 0 | 0 | 0 | 0 | 0 | 0 | 0 | 0 | 0 | 0 | 0 | 0 | 0 | 0 | 0 |

Table 7-12. OHCI Control Register Descriptioni

| BIT | FIELD NAME | TYPE | DESCRIPTION |
|------|-------------|------|---|
| 31-1 | RSVD | R | Reserved. Bits 31-1 return 000 0000 0000 0000 0000 0000 0000 0000b when read. |
| 0 | GLOBAL_SWAP | RW | When bit 0 is set to 1b, all quadlets read from and written to the PCI interface are byte-swapped (big endian). The default value for this bit is 0b which is little endian mode. |

7.17 Capability ID and Next Item Pointer Registers

The capability ID and next item pointer register identifies the linked-list capability item and provides a pointer to the next capability item. See [Table 7-13](#) for a complete description of the register contents.

PCI register offset: 44h
Register type: Read-only
Default value: 0001h

| BIT NUMBER | 15 | 14 | 13 | 12 | 11 | 10 | 9 | 8 | 7 | 6 | 5 | 4 | 3 | 2 | 1 | 0 |
|-------------|----|----|----|----|----|----|---|---|---|---|---|---|---|---|---|---|
| RESET STATE | 0 | 0 | 0 | 0 | 0 | 0 | 0 | 0 | 0 | 0 | 0 | 0 | 0 | 0 | 0 | 1 |

Table 7-13. Capability ID and Next Item Pointer Registers Description

| BIT | FIELD NAME | TYPE | DESCRIPTION |
|------|---------------|------|--|
| 15-8 | NEXT_ITEM | R | Next item pointer. The OHCI controller supports only one additional capability that is communicated to the system through the extended capabilities list; therefore, this field returns 00h when read. |
| 7-0 | CAPABILITY_ID | R | Capability identification. This field returns 01h when read, which is the unique ID assigned by the PCI SIG for PCI power-management capability. |

7.18 Power Management Capabilities Register

The power management capabilities register indicates the capabilities of the OHCI core related to PCI power management. See [Table 7-14](#) for a complete description of the register contents.

PCI register offset: 46h

Register type: Read-only

Default value: 7E03h

| BIT NUMBER | 15 | 14 | 13 | 12 | 11 | 10 | 9 | 8 | 7 | 6 | 5 | 4 | 3 | 2 | 1 | 0 |
|-------------|----|----|----|----|----|----|---|---|---|---|---|---|---|---|---|---|
| RESET STATE | 0 | 1 | 1 | 1 | 1 | 1 | 1 | 0 | 0 | 0 | 0 | 0 | 0 | 0 | 1 | 1 |

Table 7-14. Interrupt Line and Pin Registers Description

| BIT | FIELD NAME | TYPE | DESCRIPTION |
|-------|-------------|------|---|
| 15-11 | PME_SUPPORT | R | $\overline{\text{PME}}$ support. This 5-bit field indicates the power states from which the OHCI core may assert $\overline{\text{PME}}$. This field returns a value of 01111b, indicating that $\overline{\text{PME}}$ is asserted from the D3hot, D2, D1, and D0 power states. |
| 10 | D2_SUPPORT | R | D2 support. Bit 10 is hardwired to 1b, indicating that the OHCI controller supports the D2 power state. |
| 9 | D1_SUPPORT | R | D1 support. Bit 9 is hardwired to 1b, indicating that the OHCI controller supports the D1 power state. |
| 8-6 | AUX_CURRENT | R | Auxiliary current. This 3-bit field reports the 3.3- V_{AUX} auxiliary current requirements. This field returns 000b, because the 1394a core is not powered by V_{AUX} . |
| 5 | DSI | R | Device-specific initialization. This bit returns 0b when read, indicating that the OHCI controller does not require special initialization beyond the standard PCI configuration header before a generic class driver is able to use it. |
| 4 | RSVD | R | Reserved. Bit 4 returns 0b when read. |
| 3 | PME_CLK | R | $\overline{\text{PME}}$ clock. This bit returns 0b when read, indicating that no host bus clock is required for the OHCI controller to generate $\overline{\text{PME}}$. |
| 2-0 | PM_VERSION | R | Power-management version. If bit 7 (PCI_PM_VERSION_CTRL) in the PCI miscellaneous configuration register at offset F0h (see Section 7.21) is 0b, then this field returns 010b indicating Revision 1.1 compatibility. If PCI_PM_VERSION_CTRL in the PCI miscellaneous configuration register is 1b, then this field returns 011b indicating Revision 1.2 compatibility. |

7.19 Power Management Control and Status Register

The power management control and status register implements the control and status of the PCI power management function. This register is not affected by the internally-generated reset caused by the transition from the D3hot to D0 state. See [Table 7-15](#) for a complete description of the register contents.

PCI register offset: 48h

Register type: Read/Write, Read-only

Default value: 0000h

| BIT NUMBER | 15 | 14 | 13 | 12 | 11 | 10 | 9 | 8 | 7 | 6 | 5 | 4 | 3 | 2 | 1 | 0 |
|-------------|----|----|----|----|----|----|---|---|---|---|---|---|---|---|---|---|
| RESET STATE | 0 | 0 | 0 | 0 | 0 | 0 | 0 | 0 | 0 | 0 | 0 | 0 | 0 | 0 | 0 | 0 |

Table 7-15. Power Management Control and Status Register Description

| BIT | FIELD NAME | TYPE | DESCRIPTION |
|-------|-------------|------|---|
| 15 | PME_STS | R | This bit returns 0b, because PME is not supported. |
| 14-13 | DATA_SCALE | R | This field returns 00b, because the data register is not implemented. |
| 12-9 | DATA_SELECT | R | This field returns 0h, because the data register is not implemented. |
| 8 | PME_ENB | R | This bit returns 0b, because PME is not supported. |
| 7-2 | RSVD | R | Reserved. Bits 7-2 return 00 0000b when read. |

Table 7-15. Power Management Control and Status Register Description (continued)

| BIT | FIELD NAME | TYPE | DESCRIPTION |
|--------------------|------------|------|---|
| 1-0 ⁽¹⁾ | PWR_STATE | RW | Power state. This 2-bit field sets the 1394b OHCI controller power state and is encoded as follows: 00 = Current power state is D0 (default) 01 = Current power state is D1 10 = Current power state is D2 11 = Current power state is D3 |

(1) These bits are reset on the rising edge of PCI bus reset ($\overline{\text{PRST}}$).

7.20 Power Management Extension Registers

The power management extension register provides extended power-management features not applicable to the OHCI controller; thus, it is read-only and returns 0000h when read. See [Table 7-16](#) for a complete description of the register contents.

PCI register offset: 4Ah

Register type: Read-only

Default value: 0000h

| BIT NUMBER | 15 | 14 | 13 | 12 | 11 | 10 | 9 | 8 | 7 | 6 | 5 | 4 | 3 | 2 | 1 | 0 |
|-------------|----|----|----|----|----|----|---|---|---|---|---|---|---|---|---|---|
| RESET STATE | 0 | 0 | 0 | 0 | 0 | 0 | 0 | 0 | 0 | 0 | 0 | 0 | 0 | 0 | 0 | 0 |

Table 7-16. Power Management Extension Registers Description

| BIT | FIELD NAME | TYPE | DESCRIPTION |
|------|------------|------|---|
| 15-0 | RSVD | R | Reserved. Bits 15-0 return 0000h when read. |

7.21 PCI Miscellaneous Configuration Register

The PCI miscellaneous configuration register provides miscellaneous PCI-related configuration. See [Table 7-17](#) for a complete description of the register contents.

PCI register offset: F0h
 Register type: Read/Write, Read-only
 Default value: 0000 0A90h

| BIT NUMBER | 31 | 30 | 29 | 28 | 27 | 26 | 25 | 24 | 23 | 22 | 21 | 20 | 19 | 18 | 17 | 16 |
|-------------|----|----|----|----|----|----|----|----|----|----|----|----|----|----|----|----|
| RESET STATE | 0 | 0 | 0 | 0 | 0 | 0 | 0 | 0 | 0 | 0 | 0 | 0 | 0 | 0 | 0 | 0 |

| BIT NUMBER | 15 | 14 | 13 | 12 | 11 | 10 | 9 | 8 | 7 | 6 | 5 | 4 | 3 | 2 | 1 | 0 |
|-------------|----|----|----|----|----|----|---|---|---|---|---|---|---|---|---|---|
| RESET STATE | 0 | 0 | 0 | 0 | 1 | 0 | 1 | 0 | 1 | 0 | 0 | 1 | 0 | 0 | 0 | 0 |

Table 7-17. Miscellaneous Configuration Register

| BIT | FIELD NAME | TYPE | DESCRIPTION |
|--------------------|-------------------------------|------|--|
| 31-16 | RSVD | R | Reserved. Bits 31-16 return 0000h when read. |
| 15 | PME_D3COLD | R | PME support from D3cold. The 1394a OHCI core does not support PME generation from D3cold. Therefore, this bit is tied to 0b. |
| 14-12 | RSVD | R | Reserved. Bits 14-12 return 000b when read. |
| 11 | PCI2_3_EN | R | PCI 2.3 enable. The 1394 OHCI core always conforms to the PCI 2.3 specification; therefore, this bit is tied to 1b. |
| 10 | 10 IGNORE_MSTRINT_ENA_FOR_PME | RW | IGNORE_MSTRINT_ENA_FOR_PME bit for $\overline{\text{PME}}$ generation. When set, this bit causes bit 26 of the OHCI vendor ID register (OHCI offset 40h, see Section 8.15) to read 1b. Otherwise, bit 26 reads 0b. 0 = $\overline{\text{PME}}$ behavior generated from unmasked interrupt bits and IntMask.masterIntEnable bit (default) 1 = $\overline{\text{PME}}$ generation does not depend on the value of IntMask.masterIntEnable |
| 9-8 ⁽¹⁾ | MR_ENHANCE | RW | This field selects the read command behavior of the PCI master for read transactions of greater than two data phases. For read transactions of one or two data phases, a memory read command is used. 00 = Memory read line 01 = Memory read 10 = Memory read multiple (default) 11 = Reserved, behavior reverts to default |
| 7 ⁽¹⁾ | PCI_PM_VERSION_CTRL | RW | PCI power management version control. This bit controls the value reported in the Version field of the power management capabilities register of the 1394 OHCI function. 0 = Version fields report 010b for Power Management 1.1 compliance 1 = Version fields report 011b for Power Management 1.2 compliance (default) |
| 6-5 | RSVD | R | Reserved. Bits 6-5 return 00b when read. |
| 4 ⁽¹⁾ | DIS_TGT_ABT | RW | Disable target abort. Bit 4 controls the no-target-abort mode, in which the OHCI controller returns indeterminate data instead of signaling target abort. The OHCI LLC is divided into the PCLK and SCLK domains. If software tries to access registers in the link that are not active because the SCLK is disabled, then a target abort is issued by the link. On some systems, this can cause a problem resulting in a fatal system error. Enabling this bit allows the link to respond to these types of requests by returning FFh. 0 = Responds with OHCI-Lynx. compatible target abort 1 = Responds with indeterminate data equal to FFh. It is recommended that this bit be set to 1b (default) |
| 3 ⁽¹⁾ | SB_EN | RW | Serial bus enable. In the bridge, the serial bus interface is controlled using the bridge configuration registers. Therefore, this bit has no effect in the 1394b OHCI function. The default value for this bit is 0b. |
| 2 ⁽¹⁾ | DISABLE_SCLKGATE | RW | Disable SCLK test feature. This bit controls locking or unlocking the SCLK to the 1394a OHCI core PCI bus clock input. This is a test feature only and must be cleared to 0b (all applications). 0 = Hardware decides auto-gating of the PHY clock (default) 1 = Disables auto-gating of the PHY clock |

(1) These bits are reset by a PCI Express reset ($\overline{\text{PERST}}$), a $\overline{\text{GRST}}$, or the internally-generated power-on reset.

Table 7-17. Miscellaneous Configuration Register (continued)

| BIT | FIELD NAME | TYPE | DESCRIPTION |
|------------------|-----------------|------|---|
| 1 ⁽¹⁾ | DISABLE_PCIGATE | RW | Disable PCLK test feature. This bit controls locking or unlocking the PCI clock to the 1394a OHCI core PCI bus clock input. This is a test feature only and must be cleared to 0b (all applications). 0 = Hardware decides auto-gating of the PCI clock (default) 1 = Disables auto-gating of the PCI clock |
| 0 ⁽¹⁾ | KEEP_PCLK | RW | Keep PCI clock running. This bit controls the PCI clock operation during the CLKRUN protocol. Since the CLKRUN protocol is not supported in the XIO2200, this bit has no effect. The default value for this bit is 0b. |

7.22 Link Enhancement Control Register

The link enhancement control register implements TI proprietary bits that are initialized by software or by a serial EEPROM, if present. After these bits are set to 1b, their functionality is enabled only if bit 22 (aPhyEnhanceEnable) in the host controller register at OHCI offset 50h/54h (see [Section 3.3.2](#), Host Controller Control Register) is set to 1. See [Table 7-18](#) for a complete description of the register contents.

PCI register offset: F4h
Register type: Read/Write, Read-only
Default value: 0000 4000h

| BIT NUMBER | 31 | 30 | 29 | 28 | 27 | 26 | 25 | 24 | 23 | 22 | 21 | 20 | 19 | 18 | 17 | 16 |
|-------------|----|----|----|----|----|----|----|----|----|----|----|----|----|----|----|----|
| RESET STATE | 0 | 0 | 0 | 0 | 0 | 0 | 0 | 0 | 0 | 0 | 0 | 0 | 0 | 0 | 0 | 0 |

| BIT NUMBER | 15 | 14 | 13 | 12 | 11 | 10 | 9 | 8 | 7 | 6 | 5 | 4 | 3 | 2 | 1 | 0 |
|-------------|----|----|----|----|----|----|---|---|---|---|---|---|---|---|---|---|
| RESET STATE | 0 | 1 | 0 | 0 | 0 | 0 | 0 | 0 | 0 | 0 | 0 | 0 | 0 | 0 | 0 | 0 |

Table 7-18. Link Enhancement Control Register Description

| BIT | FIELD NAME | TYPE | DESCRIPTION |
|----------------------|-----------------|------|---|
| 31-16 | RSVD | R | Reserved. Bits 31-16 return 0000h when read. |
| 15 ⁽¹⁾ | dis_at_pipeline | RW | Disable AT pipelining. When bit 15 is set to 1b, out-of-order AT pipelining is disabled. The default value for this bit is 0b. |
| 14 ⁽¹⁾ | ENAB_DRAFT | RW | Enable OHCI 1.2 draft features. When this bit is set it enables some features beyond the OHCI 1.1 specification. Specifically this enables HCClear.LPS to be cleared by writing a 1 to the HCClear.LPS bit and enables the link to set bit 9 in the xferStatus field of AR and IR ContextControl registers. This bit can be initialized from an attached EEPROM. |
| 13-12 ⁽¹⁾ | atx_thresh | RW | <p>This field sets the initial AT threshold value, which is used until the AT FIFO is underrun. When the OHCI controller retries the packet, it uses a 4K-byte threshold, resulting in a store-and-forward operation.</p> <p>00 = Threshold ~ 4K bytes resulting in a store-and-forward operation (default) 01 = Threshold ~ 1.7K bytes 10 = Threshold ~ 1K bytes 11 = Threshold ~ 512 bytes</p> <p>These bits fine-tune the asynchronous transmit threshold. For most applications the 1.7K-byte threshold is optimal. Changing this value may increase or decrease the 1394 latency depending on the average PCI bus latency.</p> <p>Setting the AT threshold to 1.7K, 1K, or 512 bytes results in data being transmitted at these thresholds or when an entire packet has been checked into the FIFO. If the packet to be transmitted is larger than the AT threshold, then the remaining data must be received before the AT FIFO is emptied; otherwise, an underrun condition occurs, resulting in a packet error at the receiving node. As a result, the link then commences store-and-forward operation. Wait until it has the complete packet in the FIFO before retransmitting it on the second attempt to ensure delivery.</p> <p>An AT threshold of 4K results in store-and-forward operation, which means that asynchronous data is not transmitted until an end-of-packet token is received. Restated, setting the AT threshold to 4K results in only complete packets being transmitted.</p> <p>Note that the OHCI controller will always use store-and-forward when the asynchronous transmit retries register at OHCI offset 08h (see Section 8.3, Asynchronous Transmit Retries Register) is cleared.</p> |
| 11 | RSVD | R | Reserved. Bit 11 returns 0b when read. |
| 10 ⁽¹⁾ | enab_mpeg_ts | RW | Enable MPEG CIP timestamp enhancement. When bit 9 is set to 1b, the enhancement is enabled for MPEG CIP transmit streams (FMT = 20h). The default value for this bit is 0b. |
| 9 | RSVD | R | Reserved. Bit 9 returns 0b when read. |
| 8 ⁽¹⁾ | enab_dv_ts | RW | Enable DV CIP timestamp enhancement. When bit 8 is set to 1b, the enhancement is enabled for DV CIP transmit streams (FMT = 00h). The default value for this bit is 0b. |
| 7 ⁽¹⁾ | enab_unfair | RW | Enable asynchronous priority requests. OHCI-Lynx. compatible. Setting bit 7 to 1b enables the link to respond to requests with priority arbitration. It is recommended that this bit be set to 1b. The default value for this bit is 0b. |
| 6-3 | RSVD | R | Reserved. Bits 6-3 return 0h when read. |
| 2 ⁽¹⁾ | RSVD | RW | Reserved. Bit 2 defaults to 0b and must remain 0b for normal operation of the OHCI core. |
| 1 ⁽¹⁾ | enab_accel | RW | Enable acceleration enhancements. OHCI-Lynx. compatible. When bit 1 is set to 1b, the PHY layer is notified that the link supports the IEEE Std 1394a-2000 acceleration enhancements, that is, ack-accelerated, fly-by concatenation, etc. It is recommended that this bit be set to 1b. The default value for this bit is 0b. |
| 0 ⁽¹⁾ | RSVD | R | Reserved. Bit 0 returns 0b when read. |

7.23 Subsystem Access Register

Write access to the subsystem access register updates the subsystem identification registers identically to OHCI-Lynx.. The system ID value written to this register may also be read back from this register. See [Table 7-19](#) for a complete description of the register contents.

PCI register offset: F8h
 Register type: Read/Write
 Default value: 0000 0000h

| | | | | | | | | | | | | | | | | |
|--------------------|-----------|-----------|-----------|-----------|-----------|-----------|-----------|-----------|-----------|-----------|-----------|-----------|-----------|-----------|-----------|-----------|
| BIT NUMBER | 31 | 30 | 29 | 28 | 27 | 26 | 25 | 24 | 23 | 22 | 21 | 20 | 19 | 18 | 17 | 16 |
| RESET STATE | 0 | 0 | 0 | 0 | 0 | 0 | 0 | 0 | 0 | 0 | 0 | 0 | 0 | 0 | 0 | 0 |

| | | | | | | | | | | | | | | | | |
|--------------------|-----------|-----------|-----------|-----------|-----------|-----------|----------|----------|----------|----------|----------|----------|----------|----------|----------|----------|
| BIT NUMBER | 15 | 14 | 13 | 12 | 11 | 10 | 9 | 8 | 7 | 6 | 5 | 4 | 3 | 2 | 1 | 0 |
| RESET STATE | 0 | 0 | 0 | 0 | 0 | 0 | 0 | 0 | 0 | 0 | 0 | 0 | 0 | 0 | 0 | 0 |

Table 7-19. Subsystem Access Register Description

| BIT | FIELD NAME | TYPE | DESCRIPTION |
|----------------------|-------------------|-------------|--|
| 31-16 ⁽¹⁾ | SUBDEV_ID | RW | Subsystem device ID alias. This field indicates the subsystem device ID. |
| 15-0 ⁽¹⁾ | SUBVEN_ID | RW | Subsystem vendor ID alias. This field indicates the subsystem vendor ID. |

(1) This register shall only be reset by a Fundamental Reset ($\overline{\text{FRST}}$).

8 1394 OHCI Memory-Mapped Register Space

The OHCI registers defined by the 1394 Open Host Controller Interface Specification are memory-mapped into a 2K-byte region of memory pointed to by the OHCI base address register at offset 10h in PCI configuration space (see [Section 7.8](#)). These registers are the primary interface for controlling the IEEE 1394 link function.

This section provides the register interface and bit descriptions. Several set/clear register pairs in this programming model are implemented to solve various issues with typical read-modify-write control registers. There are two addresses for a set/clear register: RegisterSet and RegisterClear. See [Table 8-1](#) for a register listing. A 1 bit written to RegisterSet causes the corresponding bit in the set/clear register to be set to 1b; a 0 bit leaves the corresponding bit unaffected. A 1 bit written to RegisterClear causes the corresponding bit in the set/clear register to be cleared; a 0 bit leaves the corresponding bit in the set/clear register unaffected.

Typically, a read from either RegisterSet or RegisterClear returns the contents of the set or clear register, respectively. However, sometimes reading the RegisterClear provides a masked version of the set or clear register. The interrupt event register is an example of this behavior.

Table 8-1. OHCI Register Map

| DMA CONTEXT | REGISTER NAME | ABBREVIATION | OFFSET | |
|-------------|--|----------------------|---------|-----|
| — | OHCI version | Version | 00h | |
| | GUID ROM | GUID_ROM | 04h | |
| | Asynchronous transmit retries | ATRetries | 08h | |
| | CSR data | CSRData | 0Ch | |
| | CSR compare | CSRCompareData | 10h | |
| | CSR control | CSRControl | 14h | |
| | Configuration ROM header | ConfigROMhdr | 18h | |
| | Bus identification | BusID | 1Ch | |
| | Bus options ⁽¹⁾ | BusOptions | 20h | |
| | GUID high ⁽¹⁾ | GUIDHi | 24h | |
| | GUID low ⁽¹⁾ | GUIDLo | 28h | |
| | Reserved ⁽¹⁾ | — | 2Ch-30h | |
| | Configuration ROM mapping | ConfigROMmap | 34h | |
| | Posted write address low | PostedWriteAddressLo | 38h | |
| | Posted write address high | PostedWriteAddressHi | 3Ch | |
| | Vendor ID | VendorID | 40h | |
| | Reserved | — | 44h-4Ch | |
| | Host controller control ⁽¹⁾ | HCCControlSet | | 50h |
| | | HCCControlClr | | 54h |
| | Reserved | — | 58h-5Ch | |
| Self-ID | Reserved | — | 60h | |
| | Self-ID buffer pointer | SelfIDBuffer | 64h | |
| | Self-ID count | SelfIDCount | 68h | |
| | Reserved | — | 6Ch | |
| — | Isochronous receive channel mask high | IRChannelMaskHiSet | 70h | |
| | | IRChannelMaskHiClear | 74h | |
| | Isochronous receive channel mask low | IRChannelMaskLoSet | 78h | |
| | | IRChannelMaskLoClear | 7Ch | |

(1) One or more bits in this register are reset by a PCI Express reset ($\overline{\text{PERST}}$) or Fundamental Reset ($\overline{\text{FRST}}$).

Table 8-1. OHCI Register Map (continued)

| DMA CONTEXT | REGISTER NAME | ABBREVIATION | OFFSET |
|---|--------------------------------------|----------------------------|-----------|
| — | Interrupt event | IntEventSet | 80h |
| | | IntEventClear | 84h |
| | Interrupt mask | IntMaskSet | 88h |
| | | IntMaskClear | 8Ch |
| | Isochronous transmit interrupt event | IsoXmitIntEventSet | 90h |
| | | IsoXmitIntEventClear | 94h |
| | Isochronous transmit interrupt mask | IsoXmitIntMaskSet | 98h |
| | | IsoXmitIntMaskClear | 9Ch |
| | Isochronous receive interrupt event | IsoRecvIntEventSet | A0h |
| | | IsoRecvIntEventClear | A4h |
| | Isochronous receive interrupt mask | IsoRecvIntMaskSet | A8h |
| | | IsoRecvIntMaskClear | ACh |
| | Initial bandwidth available | InitialBandwidthAvailable | B0h |
| | Initial channels available high | InitialChannelsAvailableHi | B4h |
| | Initial channels available low | InitialChannelsAvailableLo | B8h |
| | Reserved | — | BCh-D8h |
| | Fairness control | FairnessControl | DCh |
| | Link control ⁽¹⁾ | LinkControlSet | E0h |
| | | LinkControlClear | E4h |
| | Node identification | NodeID | E8h |
| | PHY layer control | PhyControl | ECh |
| | Isochronous cycle timer | Isocyc timer | F0h |
| | Reserved | — | F4h-FCh |
| Asynchronous request filter high | AsyncRequestFilterHiSet | 100h | |
| | AsyncRequestFilterHiClear | 104h | |
| Asynchronous request filter low | AsyncRequestFilterLoSet | 108h | |
| | AsyncRequestFilterLoClear | 10Ch | |
| Physical request filter high | PhysicalRequestFilterHiSet | 110h | |
| | PhysicalRequestFilterHiClear | 114h | |
| Physical request filter low | PhysicalRequestFilterLoSet | 118h | |
| | PhysicalRequestFilterLoClear | 11Ch | |
| Physical Upper Bound | PhysicalUpperBound | 120h | |
| Reserved | — | 124h-17Ch | |
| Asynchronous Request Transmit [ATRQ] | Asynchronous context control | ContextControlSet | 180h |
| | | ContextControlClear | 184h |
| | Reserved | — | 188h |
| | Asynchronous context command pointer | CommandPtr | 18Ch |
| Reserved | — | 190h-19Ch | |
| Asynchronous Response Transmit [ATRS] | Asynchronous context control | ContextControlSet | 1A0h |
| | | ContextControlClear | 1A4h |
| | Reserved | — | 1A8h |
| | Asynchronous context command pointer | CommandPtr | 1ACh |
| | Reserved | — | 1B0h-1BCh |

Table 8-1. OHCI Register Map (continued)

| DMA CONTEXT | REGISTER NAME | ABBREVIATION | OFFSET |
|--|--|---------------------|-------------|
| Asynchronous Request Receive [ARRQ] | Asynchronous context control | ContextControlSet | 1C0h |
| | | ContextControlClear | 1C4h |
| | Reserved | — | 1C8h |
| | Asynchronous context command pointer | CommandPtr | 1CCh |
| | Reserved | — | 1D0h-1DCh |
| Asynchronous Response Receive [ARRS] | Asynchronous context control | ContextControlSet | 1E0h |
| | | ContextControlClear | 1E4h |
| | Reserved | — | 1E8h |
| | Asynchronous context command pointer | CommandPtr | 1ECh |
| | Reserved | — | 1F0h-1FCh |
| Isochronous Transmit Context n n = 0, 1, 2, 3, ..., 7 | Isochronous transmit context control | ContextControlSet | 200h + 16*n |
| | | ContextControlClear | 204h + 16*n |
| | Reserved | — | 208h + 16*n |
| | Isochronous transmit context command pointer | CommandPtr | 20Ch + 16*n |
| | Reserved | — | 210h-3FCh |
| Isochronous Receive Context n n = 0, 1, 2, 3 | Isochronous receive context control | ContextControlSet | 400h + 32*n |
| | | ContextControlClear | 404h + 32*n |
| | Reserved | — | 408h + 32*n |
| | Isochronous receive context command pointer | CommandPtr | 40Ch + 32*n |
| | Isochronous receive context match | ContextMatch | 410h + 32*n |

8.1 OHCI Version Register

The OHCI version register indicates the OHCI version support and whether or not the serial EEPROM is present. See [Table 8-2](#) for a complete description of the register contents.

OHCI register offset: 00h
 Register type: Read-only
 Default value: 0X01 0010h

| | | | | | | | | | | | | | | | | |
|--------------------|----|----|----|----|----|----|----|----|----|----|----|----|----|----|----|----|
| BIT NUMBER | 31 | 30 | 29 | 28 | 27 | 26 | 25 | 24 | 23 | 22 | 21 | 20 | 19 | 18 | 17 | 16 |
| RESET STATE | 0 | 0 | 0 | 0 | 0 | 0 | 0 | X | 0 | 0 | 0 | 0 | 0 | 0 | 0 | 1 |

| | | | | | | | | | | | | | | | | |
|--------------------|----|----|----|----|----|----|---|---|---|---|---|---|---|---|---|---|
| BIT NUMBER | 15 | 14 | 13 | 12 | 11 | 10 | 9 | 8 | 7 | 6 | 5 | 4 | 3 | 2 | 1 | 0 |
| RESET STATE | 0 | 0 | 0 | 0 | 0 | 0 | 0 | 0 | 0 | 0 | 0 | 1 | 0 | 0 | 0 | 0 |

Table 8-2. OHCI Version Register Description

| BIT | FIELD NAME | TYPE | DESCRIPTION |
|-------------------|------------|------|---|
| 31-25 | RSVD | R | Reserved. Bits 31-25 return 000 0000b when read. |
| 24 ⁽¹⁾ | GUID_ROM | RU | The controller sets bit 24 to 1b if the serial EEPROM is detected. If the serial EEPROM is present, then the Bus_Info_Block is automatically loaded on system (hardware) reset. The default value for this bit is 0b. |
| 23-16 | version | R | Major version of the OHCI. The controller is compliant with the <i>1394 Open Host Controller Interface Specification</i> (Release 1.2); thus, this field reads 01h. |
| 15-8 | RSVD | R | Reserved. Bits 15-8 return 00h when read. |
| 7-0 | revision | R | Minor version of the OHCI. The controller is compliant with the <i>1394 Open Host Controller Interface Specification</i> (Release 1.2); thus, this field reads 10h. |

(1) One or more bits in this register are reset by a PCI Express reset ($\overline{\text{PERST}}$) or a Fundamental Reset ($\overline{\text{FRST}}$).

8.2 GUID ROM Register

The GUID ROM register accesses the serial EEPROM, and is only applicable if bit 24 (GUID_ROM) in the OHCI version register at OHCI offset 00h (see [Section 8.1](#)) is set to 1b. See [Table 8-3](#) for a complete description of the register contents.

OHCI register offset: 04h
 Register type: Read/Set/Update, Read/Update, Read-only
 Default value: 00XX 0000h

| | | | | | | | | | | | | | | | | |
|--------------------|-----------|-----------|-----------|-----------|-----------|-----------|-----------|-----------|-----------|-----------|-----------|-----------|-----------|-----------|-----------|-----------|
| BIT NUMBER | 31 | 30 | 29 | 28 | 27 | 26 | 25 | 24 | 23 | 22 | 21 | 20 | 19 | 18 | 17 | 16 |
| RESET STATE | 0 | 0 | 0 | 0 | 0 | 0 | 0 | 0 | X | X | X | X | X | X | X | X |

| | | | | | | | | | | | | | | | | |
|--------------------|-----------|-----------|-----------|-----------|-----------|-----------|----------|----------|----------|----------|----------|----------|----------|----------|----------|----------|
| BIT NUMBER | 15 | 14 | 13 | 12 | 11 | 10 | 9 | 8 | 7 | 6 | 5 | 4 | 3 | 2 | 1 | 0 |
| RESET STATE | 0 | 0 | 0 | 0 | 0 | 0 | 0 | 0 | 0 | 0 | 0 | 0 | 0 | 0 | 0 | 0 |

Table 8-3. GUID ROM Register Description

| BIT | FIELD NAME | TYPE | DESCRIPTION |
|-------|------------|------|--|
| 31 | addrReset | RSU | Software sets bit 31 to 1b to reset the GUID ROM address to 0. When the controller completes the reset, it clears this bit. The controller does not automatically fill bits 23-16 (rdData field) with the 0 th byte. |
| 30-26 | RSVD | R | Reserved. Bits 30-26 return 00 0000b when read. |
| 25 | rdStart | RSU | A read of the currently addressed byte is started when bit 25 is set to 1b. This bit is automatically cleared when the controller completes the read of the currently addressed GUID ROM byte. |
| 24 | RSVD | R | Reserved. Bit 24 returns 0b when read. |
| 23-16 | rdData | RU | This field contains the data read from the GUID ROM. |
| 15-8 | RSVD | R | Reserved. Bits 15-8 return 00h when read. |
| 7-0 | miniROM | R | The miniROM field defaults to 00h indicating that no mini-ROM is implemented. If an EEPROM is implemented, then all 8 bits of this miniROM field are downloaded from EEPROM word offset 28h. For this device, the miniROM field must be greater than 39h to indicate a valid miniROM offset into the EEPROM. |

8.3 Asynchronous Transmit Retries Register

The asynchronous transmit retries register indicates the number of times the controller attempts a retry for asynchronous DMA request transmit and for asynchronous physical and DMA response transmit. See [Table 8-4](#) for a complete description of the register contents.

OHCI register offset: 08h
 Register type: Read/Write, Read-only
 Default value: 0000 0000h

| | | | | | | | | | | | | | | | | |
|--------------------|----|----|----|----|----|----|----|----|----|----|----|----|----|----|----|----|
| BIT NUMBER | 31 | 30 | 29 | 28 | 27 | 26 | 25 | 24 | 23 | 22 | 21 | 20 | 19 | 18 | 17 | 16 |
| RESET STATE | 0 | 0 | 0 | 0 | 0 | 0 | 0 | 0 | 0 | 0 | 0 | 0 | 0 | 0 | 0 | 0 |
| BIT NUMBER | 15 | 14 | 13 | 12 | 11 | 10 | 9 | 8 | 7 | 6 | 5 | 4 | 3 | 2 | 1 | 0 |
| RESET STATE | 0 | 0 | 0 | 0 | 0 | 0 | 0 | 0 | 0 | 0 | 0 | 0 | 0 | 0 | 0 | 0 |

Table 8-4. Asynchronous Transmit Retries Register Description

| BIT | FIELD NAME | TYPE | DESCRIPTION |
|-------|--------------------|------|---|
| 31-29 | secondLimit | R | The second limit field returns 000b when read, because outbound dual-phase retry is not implemented. |
| 28-16 | cycleLimit | R | The cycle limit field returns 0 0000 0000 0000b when read, because outbound dual-phase retry is not implemented. |
| 15-12 | RSVD | R | Reserved. Bits 15-12 return 0h when read. |
| 11-8 | maxPhysRespRetries | RW | This field tells the physical response unit how many times to attempt to retry the transmit operation for the response packet when a busy acknowledge or ack_data_error is received from the target node. The default value for this field is 0h. |
| 7-4 | maxATRespRetries | RW | This field tells the asynchronous transmit response unit how many times to attempt to retry the transmit operation for the response packet when a busy acknowledge or ack_data_error is received from the target node. The default value for this field is 0h. |
| 3-0 | maxATReqRetries | RW | This field tells the asynchronous transmit DMA request unit how many times to attempt to retry the transmit operation for the response packet when a busy acknowledge or ack_data_error is received from the target node. The default value for this field is 0h. |

8.4 CSR Data Register

The CSR data register accesses the bus management CSR registers from the host through compare-swap operations. This register contains the data to be stored in a CSR if the compare is successful.

OHCI register offset: 0Ch
 Register type: Read-only
 Default value: XXXX XXXXh

| | | | | | | | | | | | | | | | | |
|--------------------|----|----|----|----|----|----|----|----|----|----|----|----|----|----|----|----|
| BIT NUMBER | 31 | 30 | 29 | 28 | 27 | 26 | 25 | 24 | 23 | 22 | 21 | 20 | 19 | 18 | 17 | 16 |
| RESET STATE | X | X | X | X | X | X | X | X | X | X | X | X | X | X | X | X |
| BIT NUMBER | 15 | 14 | 13 | 12 | 11 | 10 | 9 | 8 | 7 | 6 | 5 | 4 | 3 | 2 | 1 | 0 |
| RESET STATE | X | X | X | X | X | X | X | X | X | X | X | X | X | X | X | X |

8.5 CSR Compare Register

The CSR compare register accesses the bus management CSR registers from the host through compare-swap operations. This register contains the data to be compared with the existing value of the CSR resource.

OHCI register offset: 10h
 Register type: Read-only
 Default value: XXXX XXXXh

| | | | | | | | | | | | | | | | | |
|--------------------|----|----|----|----|----|----|----|----|----|----|----|----|----|----|----|----|
| BIT NUMBER | 31 | 30 | 29 | 28 | 27 | 26 | 25 | 24 | 23 | 22 | 21 | 20 | 19 | 18 | 17 | 16 |
| RESET STATE | X | X | X | X | X | X | X | X | X | X | X | X | X | X | X | X |

| | | | | | | | | | | | | | | | | |
|--------------------|----|----|----|----|----|----|---|---|---|---|---|---|---|---|---|---|
| BIT NUMBER | 15 | 14 | 13 | 12 | 11 | 10 | 9 | 8 | 7 | 6 | 5 | 4 | 3 | 2 | 1 | 0 |
| RESET STATE | X | X | X | X | X | X | X | X | X | X | X | X | X | X | X | X |

8.6 CSR Control Register

The CSR control register accesses the bus management CSR registers from the host through compare-swap operations. This register controls the compare-swap operation and selects the CSR resource. See Table 8-5 for a complete description of the register contents.

OHCI register offset: 14h
 Register type: Read/Write, Read/Update, Read-only
 Default value: 8000 000Xh

| | | | | | | | | | | | | | | | | |
|--------------------|----|----|----|----|----|----|----|----|----|----|----|----|----|----|----|----|
| BIT NUMBER | 31 | 30 | 29 | 28 | 27 | 26 | 25 | 24 | 23 | 22 | 21 | 20 | 19 | 18 | 17 | 16 |
| RESET STATE | 1 | 0 | 0 | 0 | 0 | 0 | 0 | 0 | 0 | 0 | 0 | 0 | 0 | 0 | 0 | 0 |

| | | | | | | | | | | | | | | | | |
|--------------------|----|----|----|----|----|----|---|---|---|---|---|---|---|---|---|---|
| BIT NUMBER | 15 | 14 | 13 | 12 | 11 | 10 | 9 | 8 | 7 | 6 | 5 | 4 | 3 | 2 | 1 | 0 |
| RESET STATE | 0 | 0 | 0 | 0 | 0 | 0 | 0 | 0 | 0 | 0 | 0 | 0 | 0 | 0 | X | X |

Table 8-5. CSR Control Register Description

| BIT | FIELD NAME | TYPE | DESCRIPTION |
|------|------------|------|--|
| 31 | csrDpme | RU | Bit 31 is set to 1b by the controller when a compare-swap operation is complete. It is cleared whenever this register is written. |
| 32-2 | RSVD | R | Reserved. Bits 30-2 return 0 0000 0000 0000 0000 0000 0000 0000b when read. |
| 1-0 | csrSel | RW | This field selects the CSR resource as follows: 00 = BUS_MANAGER_ID 01 = BANDWIDTH_AVAILABLE 10 = CHANNELS_AVAILABLE_HI 11 = CHANNELS_AVAILABLE_LO |

8.7 Configuration ROM Header Register

The configuration ROM header register externally maps to the first quadlet of the 1394 configuration ROM, offset FFFF F000 0400h. See Table 8-6 for a complete description of the register contents.

OHCI register offset: 18h
 Register type: Read/Write
 Default value: 0000 XXXXh

| | | | | | | | | | | | | | | | | |
|--------------------|----|----|----|----|----|----|----|----|----|----|----|----|----|----|----|----|
| BIT NUMBER | 31 | 30 | 29 | 28 | 27 | 26 | 25 | 24 | 23 | 22 | 21 | 20 | 19 | 18 | 17 | 16 |
| RESET STATE | 0 | 0 | 0 | 0 | 0 | 0 | 0 | 0 | 0 | 0 | 0 | 0 | 0 | 0 | 0 | 0 |

| BIT NUMBER | 15 | 14 | 13 | 12 | 11 | 10 | 9 | 8 | 7 | 6 | 5 | 4 | 3 | 2 | 1 | 0 |
|-------------|----|----|----|----|----|----|---|---|---|---|---|---|---|---|---|---|
| RESET STATE | X | X | X | X | X | X | X | X | X | X | X | X | X | X | X | X |

Table 8-6. Configuration ROM Header Register Description

| BIT | FIELD NAME | TYPE | DESCRIPTION |
|-------|---------------|------|--|
| 31-24 | info_length | RW | IEEE 1394 bus-management field. Must be valid when bit 17 (linkEnable) in the host controller control register at OHCI offset 50h/54h (see Section 3.3.2) is set to 1b. The default value for this field is 0h. |
| 23-16 | crc_length | RW | IEEE 1394 bus-management field. Must be valid when bit 17 (linkEnable) in the host controller control register at OHCI offset 50h/54h (see Section 3.3.2) is set to 1b. The default value for this field is 0h. |
| 15-0 | rom_crc_value | RW | IEEE 1394 bus-management field. Must be valid at any time bit 17 (linkEnable) in the host controller control register at OHCI offset 50h/54h (see Section 3.3.2) is set to 1b. |

8.8 Bus Identification Register

The bus identification register externally maps to the first quadlet in the Bus_Info_Block and contains the constant 3133 3934h, which is the ASCII value of 1394.

OHCI register offset: 1Ch
 Register type: Read-only
 Default value: 3133 3934h

| BIT NUMBER | 31 | 30 | 29 | 28 | 27 | 26 | 25 | 24 | 23 | 22 | 21 | 20 | 19 | 18 | 17 | 16 |
|-------------|----|----|----|----|----|----|----|----|----|----|----|----|----|----|----|----|
| RESET STATE | 0 | 0 | 1 | 1 | 0 | 0 | 0 | 1 | 0 | 0 | 1 | 1 | 0 | 0 | 1 | 1 |

| BIT NUMBER | 15 | 14 | 13 | 12 | 11 | 10 | 9 | 8 | 7 | 6 | 5 | 4 | 3 | 2 | 1 | 0 |
|-------------|----|----|----|----|----|----|---|---|---|---|---|---|---|---|---|---|
| RESET STATE | 0 | 0 | 1 | 1 | 1 | 0 | 0 | 1 | 0 | 0 | 1 | 1 | 0 | 1 | 0 | 0 |

8.9 Bus Options Register

The bus options register externally maps to the second quadlet of the Bus_Info_Block. See [Table 8-7](#) for a complete description of the register contents.

OHCI register offset: 20h
 Register type: Read/Write, Read-only
 Default value: 0000 B0X3h

| BIT NUMBER | 31 | 30 | 29 | 28 | 27 | 26 | 25 | 24 | 23 | 22 | 21 | 20 | 19 | 18 | 17 | 16 |
|-------------|----|----|----|----|----|----|----|----|----|----|----|----|----|----|----|----|
| RESET STATE | 0 | 0 | 0 | 0 | 0 | 0 | 0 | 0 | 0 | 0 | 0 | 0 | 0 | 0 | 0 | 0 |

| BIT NUMBER | 15 | 14 | 13 | 12 | 11 | 10 | 9 | 8 | 7 | 6 | 5 | 4 | 3 | 2 | 1 | 0 |
|-------------|----|----|----|----|----|----|---|---|---|---|---|---|---|---|---|---|
| RESET STATE | 1 | 0 | 1 | 1 | 0 | 0 | 0 | 0 | X | X | 0 | 0 | 0 | 0 | 1 | 1 |

Table 8-7. Bus Options Register Description

| BIT | FIELD NAME | TYPE | DESCRIPTION |
|-----|------------|------|--|
| 31 | irmc | RW | Isochronous resource-manager capable. IEEE 1394 bus-management field. Must be valid when bit 17 (linkEnable) in the host controller control register at OHCI offset 50h/54h (see Section 3.3.2) is set to 1b. The default value for this bit is 0b. |
| 30 | cmc | RW | Cycle master capable. IEEE 1394 bus-management field. Must be valid when bit 17 (linkEnable) in the host controller control register at OHCI offset 50h/54h (see Section 3.3.2) is set to 1b. The default value for this bit is 0b. |
| 29 | isc | RW | Isochronous support capable. IEEE 1394 bus-management field. Must be valid when bit 17 (linkEnable) in the host controller control register at OHCI offset 50h/54h (see Section 3.3.2) is set to 1b. The default value for this bit is 0b. |

Table 8-7. Bus Options Register Description (continued)

| BIT | FIELD NAME | TYPE | DESCRIPTION |
|----------------------|-------------|------|---|
| 28 | bmc | RW | Bus manager capable. IEEE 1394 bus-management field. Must be valid when bit 17 (linkEnable) in the host controller control register at OHCI offset 50h/54h (see Section 3.3.2) is set to 1b. The default value for this bit is 0b. |
| 27 | pmc | RW | Power-management capable. IEEE 1394 bus-management field. When bit 27 is set to 1b, this indicates that the node is power-management capable. Must be valid when bit 17 (linkEnable) in the host controller control register at OHCI offset 50h/54h (see Section 3.3.2) is set to 1b. The default value for this bit is 0b. |
| 26-24 | RSVD | R | Reserved. Bits 26-24 return 000b when read. |
| 23-16 | cyc_clk_acc | RW | Cycle master clock accuracy, in parts per million. IEEE 1394 bus-management field. Must be valid when bit 17 (linkEnable) in the host controller control register at OHCI offset 50h/54h (see Section 3.3.2) is set to 1b. The default value for this field is 00h. |
| 15-12 ⁽¹⁾ | max_rec | RW | Maximum request. IEEE 1394 bus-management field. Hardware initializes this field to indicate the maximum number of bytes in a block request packet that is supported by the implementation. This value, max_rec_bytes, must be 512 or greater, and is calculated by $2^{(\max_rec + 1)}$. Software may change this field; however, this field must be valid at any time bit 17 (linkEnable) in the host controller control register at OHCI offset 50h/54h (see Section 3.3.2) is set to 1b. A received block write request packet with a length greater than max_rec_bytes may generate an ack_type_error. This field is not affected by a software reset, and defaults to value indicating 4096 bytes on a system (hardware) reset. The default value for this field is Bh. |
| 11-8 | RSVD | R | Reserved. Bits 11-8 return 0h when read. |
| 7-6 | g | RW | Generation counter. This field is incremented if any portion of the configuration ROM has been incremented since the prior bus reset. |
| 5-3 | RSVD | R | Reserved. Bits 5-3 return 000b when read. |
| 2-0 | Lnk_spd | R | Link speed. This field returns 011b, indicating that the link speeds of 100M bits/s, 200M bits/s, 400M bits/s, and 800M bits/s are supported. |

(1) These bits are reset by a PCI Express reset ($\overline{\text{PERST}}$) or a Fundamental Reset ($\overline{\text{FRST}}$).

8.10 GUID High Register

The GUID high register represents the upper quadlet in a 64-bit global unique ID (GUID) which maps to the third quadlet in the Bus_Info_Block. This register contains node_vendor_ID and chip_ID_hi fields. This register initializes to 0000 0000h on a system (hardware) reset, which is an illegal GUID value. If a serial EEPROM is detected, then the contents of this register are loaded through the serial EEPROM interface. At that point, the contents of this register cannot be changed. If no serial EEPROM is detected, then the contents of this register are loaded by the BIOS. At that point, the contents of this register cannot be changed. This register is reset by a PCI Express reset ($\overline{\text{PERST}}$), a $\overline{\text{GRST}}$, or the internally-generated power-on reset.

OHCI register offset: 24h
Register type: Read-only
Default value: 0000 0000h

| | | | | | | | | | | | | | | | | |
|--------------------|----|----|----|----|----|----|----|----|----|----|----|----|----|----|----|----|
| BIT NUMBER | 31 | 30 | 29 | 28 | 27 | 26 | 25 | 24 | 23 | 22 | 21 | 20 | 19 | 18 | 17 | 16 |
| RESET STATE | 0 | 0 | 0 | 0 | 0 | 0 | 0 | 0 | 0 | 0 | 0 | 0 | 0 | 0 | 0 | 0 |
| BIT NUMBER | 15 | 14 | 13 | 12 | 11 | 10 | 9 | 8 | 7 | 6 | 5 | 4 | 3 | 2 | 1 | 0 |
| RESET STATE | 0 | 0 | 0 | 0 | 0 | 0 | 0 | 0 | 0 | 0 | 0 | 0 | 0 | 0 | 0 | 0 |

8.11 GUID Low Register

The GUID low register represents the lower quadlet in a 64-bit global unique ID (GUID) which maps to chip_ID_lo in the Bus_Info_Block. This register initializes to 0000 0000h on a system (hardware) reset and behaves identical to the GUID high register at OHCI offset 24h (see [Section 8.10](#)). This register is reset by a PCI Express reset (PERST), a GRST, or the internally-generated power-on reset.

OHCI register offset: 28h
 Register type: Read-only
 Default value: 0000 0000h

| | | | | | | | | | | | | | | | | |
|--------------------|-----------|-----------|-----------|-----------|-----------|-----------|-----------|-----------|-----------|-----------|-----------|-----------|-----------|-----------|-----------|-----------|
| BIT NUMBER | 31 | 30 | 29 | 28 | 27 | 26 | 25 | 24 | 23 | 22 | 21 | 20 | 19 | 18 | 17 | 16 |
| RESET STATE | 0 | 0 | 0 | 0 | 0 | 0 | 0 | 0 | 0 | 0 | 0 | 0 | 0 | 0 | 0 | 0 |

| | | | | | | | | | | | | | | | | |
|--------------------|-----------|-----------|-----------|-----------|-----------|-----------|----------|----------|----------|----------|----------|----------|----------|----------|----------|----------|
| BIT NUMBER | 15 | 14 | 13 | 12 | 11 | 10 | 9 | 8 | 7 | 6 | 5 | 4 | 3 | 2 | 1 | 0 |
| RESET STATE | 0 | 0 | 0 | 0 | 0 | 0 | 0 | 0 | 0 | 0 | 0 | 0 | 0 | 0 | 0 | 0 |

8.12 Configuration ROM Mapping Register

The configuration ROM mapping register contains the start address within system memory that maps to the start address of 1394 configuration ROM for this node. See [Table 8-8](#) for a complete description of the register contents.

OHCI register offset: 34h
 Register type: Read/Write
 Default value: 0000 0000h

| | | | | | | | | | | | | | | | | |
|--------------------|-----------|-----------|-----------|-----------|-----------|-----------|-----------|-----------|-----------|-----------|-----------|-----------|-----------|-----------|-----------|-----------|
| BIT NUMBER | 31 | 30 | 29 | 28 | 27 | 26 | 25 | 24 | 23 | 22 | 21 | 20 | 19 | 18 | 17 | 16 |
| RESET STATE | 0 | 0 | 0 | 0 | 0 | 0 | 0 | 0 | 0 | 0 | 0 | 0 | 0 | 0 | 0 | 0 |

| | | | | | | | | | | | | | | | | |
|--------------------|-----------|-----------|-----------|-----------|-----------|-----------|----------|----------|----------|----------|----------|----------|----------|----------|----------|----------|
| BIT NUMBER | 15 | 14 | 13 | 12 | 11 | 10 | 9 | 8 | 7 | 6 | 5 | 4 | 3 | 2 | 1 | 0 |
| RESET STATE | 0 | 0 | 0 | 0 | 0 | 0 | 0 | 0 | 0 | 0 | 0 | 0 | 0 | 0 | 0 | 0 |

Table 8-8. Configuration ROM Mapping Register Description

| BIT | FIELD NAME | TYPE | DESCRIPTION |
|-------|---------------|------|--|
| 31-10 | configROMAddr | RW | If a quadlet read request to 1394 offset FFFF F000 0400h through offset FFFF F000 07FFh is received, then the low-order 10 bits of the offset are added to this register to determine the host memory address of the read request. The default value for this field is all 0s. |
| 9-0 | RSVD | R | Reserved. Bits 9-0 return 00 0000 0000b when read. |

8.13 Posted Write Address Low Register

The posted write address low register communicates error information if a write request is posted and an error occurs while the posted data packet is being written. See [Table 8-9](#) for a complete description of the register contents.

OHCI register offset: 38h
 Register type: Read/Update
 Default value: XXXX XXXXh

| | | | | | | | | | | | | | | | | |
|--------------------|-----------|-----------|-----------|-----------|-----------|-----------|-----------|-----------|-----------|-----------|-----------|-----------|-----------|-----------|-----------|-----------|
| BIT NUMBER | 31 | 30 | 29 | 28 | 27 | 26 | 25 | 24 | 23 | 22 | 21 | 20 | 19 | 18 | 17 | 16 |
| RESET STATE | X | X | X | X | X | X | X | X | X | X | X | X | X | X | X | X |

| | | | | | | | | | | | | | | | | |
|--------------------|-----------|-----------|-----------|-----------|-----------|-----------|----------|----------|----------|----------|----------|----------|----------|----------|----------|----------|
| BIT NUMBER | 15 | 14 | 13 | 12 | 11 | 10 | 9 | 8 | 7 | 6 | 5 | 4 | 3 | 2 | 1 | 0 |
| RESET STATE | X | X | X | X | X | X | X | X | X | X | X | X | X | X | X | X |

Table 8-9. Posted Write Address Low Register Description

| BIT | FIELD NAME | TYPE | DESCRIPTION |
|------|------------|------|--|
| 31-0 | offsetLo | RU | The lower 32 bits of the 1394 destination offset of the write request that failed. |

8.14 Posted Write Address High Register

The posted write address high register communicates error information if a write request is posted and an error occurs while writing the posted data packet. See [Table 8-10](#) for a complete description of the register contents.

OHCI register offset: 3Ch
Register type: Read/Update
Default value: XXXX XXXXh

| BIT NUMBER | 31 | 30 | 29 | 28 | 27 | 26 | 25 | 24 | 23 | 22 | 21 | 20 | 19 | 18 | 17 | 16 |
|-------------|----|----|----|----|----|----|----|----|----|----|----|----|----|----|----|----|
| RESET STATE | X | X | X | X | X | X | X | X | X | X | X | X | X | X | X | X |

| BIT NUMBER | 15 | 14 | 13 | 12 | 11 | 10 | 9 | 8 | 7 | 6 | 5 | 4 | 3 | 2 | 1 | 0 |
|-------------|----|----|----|----|----|----|---|---|---|---|---|---|---|---|---|---|
| RESET STATE | X | X | X | X | X | X | X | X | X | X | X | X | X | X | X | X |

Table 8-10. Posted Write Address High Register Description

| BIT | FIELD NAME | TYPE | DESCRIPTION |
|-------|------------|------|--|
| 31-16 | sourceID | RU | This field is the 10-bit bus number (bits 31-22) and 6-bit node number (bits 21-16) of the node that issued the write request that failed. |
| 15-0 | offsetHi | RU | The upper 16 bits of the 1394 destination offset of the write request that failed. |

8.15 Vendor ID Register

The vendor ID register holds the company ID of an organization that specifies any vendor-unique registers. The controller implements Texas Instruments unique behavior with regards to OHCI. Thus, this register is read-only and returns 0x08 0028h when read.

OHCI register offset: 40h
Register type: Read-only
Default value: 0x08 0028h

| BIT NUMBER | 31 | 30 | 29 | 28 | 27 | 26 | 25 | 24 | 23 | 22 | 21 | 20 | 19 | 18 | 17 | 16 |
|-------------|----|----|----|----|----|----|----|----|----|----|----|----|----|----|----|----|
| RESET STATE | 0 | 0 | 0 | 0 | 0 | x | x | 1 | 0 | 0 | 0 | 0 | 1 | 0 | 0 | 0 |

| BIT NUMBER | 15 | 14 | 13 | 12 | 11 | 10 | 9 | 8 | 7 | 6 | 5 | 4 | 3 | 2 | 1 | 0 |
|-------------|----|----|----|----|----|----|---|---|---|---|---|---|---|---|---|---|
| RESET STATE | 0 | 0 | 0 | 0 | 0 | 0 | 0 | 0 | 0 | 0 | 1 | 0 | 1 | 0 | 0 | 0 |

8.16 Host Controller Control Register

The host controller control set/clear register pair provides flags for controlling the controller. See [Table 8-11](#) for a complete description of the register contents.

OHCI register offset: 50h set register
54h clear register
Register type: Read/Set/Clear/Update, Read/Set/Clear, Read/Clear, Read-only
Default value: 0080 0000h

| BIT NUMBER | 31 | 30 | 29 | 28 | 27 | 26 | 25 | 24 | 23 | 22 | 21 | 20 | 19 | 18 | 17 | 16 |
|-------------|----|----|----|----|----|----|----|----|----|----|----|----|----|----|----|----|
| RESET STATE | 0 | 0 | 0 | 0 | 0 | 0 | 0 | 0 | 1 | 0 | 0 | 0 | 0 | 0 | 0 | 0 |

| BIT NUMBER | 15 | 14 | 13 | 12 | 11 | 10 | 9 | 8 | 7 | 6 | 5 | 4 | 3 | 2 | 1 | 0 |
|-------------|----|----|----|----|----|----|---|---|---|---|---|---|---|---|---|---|
| RESET STATE | 0 | 0 | 0 | 0 | 0 | 0 | 0 | 0 | 0 | 0 | 0 | 0 | 0 | 0 | 0 | 0 |

Table 8-11. Host Controller Control Register Description

| BIT | FIELD NAME | TYPE | DESCRIPTION |
|-------------------|-------------------|------|--|
| 31 | BIBimageValid | RSU | <p>When bit 31 is set to 1b, the physical response unit is enabled to respond to block read requests to host configuration ROM and to the mechanism for atomically updating configuration ROM. Software creates a valid image of the bus_info_block in host configuration ROM before setting this bit.</p> <p>When this bit is cleared, the controller returns ack_type_error on block read requests to host configuration ROM. Also, when this bit is cleared and a 1394 bus reset occurs, the configuration ROM mapping register at OHCI offset 34h (see Section 8.12), configuration ROM header register at OHCI offset 18h (see Section 8.7), and bus options register at OHCI offset 20h (see Section 8.9) are not updated.</p> <p>Software can set this bit only when bit 17 (linkEnable) is 0b. Once bit 31 is set to 1b, it can be cleared by a system (hardware) reset, a software reset, or if a fetch error occurs when the controller loads bus_info_block registers from host memory.</p> |
| 30 | noByteSwapData | RSC | Bit 30 controls whether physical accesses to locations outside the controller itself, as well as any other DMA data accesses are byte swapped. |
| 29 | ack_Tardy_enable | RSC | <p>Bit 29 controls the acknowledgement of ack_tardy. When bit 29 is set to 1b, ack_tardy may be returned as an acknowledgment to accesses from the 1394 bus to the controller, including accesses to the bus_info_block. The controller returns ack_tardy to all other asynchronous packets addressed to the node. When the controller sends ack_tardy, bit 27 (ack_tardy) in the interrupt event register at OHCI offset 80h/84h (see Section 8.21) is set to 1b to indicate the attempted asynchronous access.</p> <p>Software ensures that bit 27 (ack_tardy) in the interrupt event register is 0b. Software also unmask wake-up interrupt events such as bit 19 (phy) and bit 27 (ack_tardy) in the interrupt event register before placing the controller into the D1 power mode.</p> <p>Software must not set this bit if the node is the 1394 bus manager.</p> |
| 28-24 | RSVD | R | Reserved. Bits 28-24 return 00000b when read. |
| 23 ⁽¹⁾ | programPhyEnable | RC | Bit 23 informs upper-level software that lower-level software has consistently configured the IEEE 1394a-2000 enhancements in the link and PHY layers. When this bit is 1b, generic software such as the OHCI driver is responsible for configuring IEEE 1394a-2000 enhancements in the PHY layer and bit 22 (aPhyEnhanceEnable). When this bit is 0b, the generic software may not modify the IEEE 1394a-2000 enhancements in the PHY layer and cannot interpret the setting of bit 22 (aPhyEnhanceEnable). This bit is initialized from serial EEPROM. |
| 22 | aPhyEnhanceEnable | RSC | When bits 23 (programPhyEnable) and 17 (linkEnable) are 11b, the OHCI driver can set bit 22 to 1b to use all IEEE 1394a-2000 enhancements. When bit 23 (programPhyEnable) is cleared to 0b, the software does not change PHY enhancements or this bit. |
| 21-20 | RSVD | R | Reserved. Bits 21 and 20 return 00b when read. |
| 19 | LPS | RSC | <p>Bit 19 controls the link power status. Software must set this bit to 1b to permit the link-PHY communication. A 0b prevents link-PHY communication.</p> <p>The OHCI-link is divided into two clock domains (PCLK and PHY_SCLK). If software tries to access any register in the PHY_SCLK domain while the PHY_SCLK is disabled, then a target abort is issued by the link. This problem can be avoided by setting bit 4 (DIS_TGT_ABT) to 1b in the PCI miscellaneous configuration register at offset F0h in the PCI configuration space (see Section 7.21). This allows the link to respond to these types of request by returning all Fs (hex).</p> <p>OHCI registers at offsets DCh-F0h and 100h-11Ch are in the PHY_SCLK domain.</p> <p>After setting LPS, software must wait approximately 10 ms before attempting to access any of the OHCI registers. This gives the PHY_SCLK time to stabilize.</p> |
| 18 | postedWriteEnable | RSC | Bit 18 enables (1) or disables (0) posted writes. Software changes this bit only when bit 17 (linkEnable) is 0b. |
| 17 | linkEnable | RSC | Bit 17 is cleared to 0b by either a system (hardware) or software reset. Software must set this bit to 1b when the system is ready to begin operation and then force a bus reset. This bit is necessary to keep other nodes from sending transactions before the local system is ready. When this bit is cleared, the controller is logically and immediately disconnected from the 1394 bus, no packets are received or processed, nor are packets transmitted. |

(1) This bit is reset by a PCI Express reset ($\overline{\text{PERST}}$) or a Fundamental Reset ($\overline{\text{FRST}}$).

Table 8-11. Host Controller Control Register Description (continued)

| BIT | FIELD NAME | TYPE | DESCRIPTION |
|------|------------|------|--|
| 16 | SoftReset | RSCU | When bit 16 is set to 1b, all states are reset, all FIFOs are flushed, and all OHCI registers are set to their system (hardware) reset values, unless otherwise specified. PCI registers are not affected by this bit. This bit remains set to 1b while the software reset is in progress and reverts back to 0b when the reset has completed. |
| 15-0 | RSVD | R | Reserved. Bits 15-0 return 0000h when read. |

8.17 Self-ID Buffer Pointer Register

The self-ID buffer pointer register points to the 2K-byte aligned base address of the buffer in host memory where the self-ID packets are stored during bus initialization. Bits 31-11 are read/write accessible. Bits 10-0 are reserved, and return 000 0000 0000b when read.

OHCI register offset: 64h
Register type: Read/Write, Read-only
Default value: XXXX XX00h

| BIT NUMBER | 31 | 30 | 29 | 28 | 27 | 26 | 25 | 24 | 23 | 22 | 21 | 20 | 19 | 18 | 17 | 16 |
|-------------|----|----|----|----|----|----|----|----|----|----|----|----|----|----|----|----|
| RESET STATE | X | X | X | X | X | X | X | X | X | X | X | X | X | X | X | X |

| BIT NUMBER | 15 | 14 | 13 | 12 | 11 | 10 | 9 | 8 | 7 | 6 | 5 | 4 | 3 | 2 | 1 | 0 |
|-------------|----|----|----|----|----|----|---|---|---|---|---|---|---|---|---|---|
| RESET STATE | X | X | X | X | X | 0 | 0 | 0 | 0 | 0 | 0 | 0 | 0 | 0 | 0 | 0 |

8.18 Self-ID Count Register

The self-ID count register keeps a count of the number of times the bus self-ID process has occurred, flags self-ID packet errors, and keeps a count of the self-ID data in the self-ID buffer. See [Table 8-12](#) for a complete description of the register contents.

OHCI register offset: 68h
Register type: Read/Update, Read-only
Default value: X0XX 0000h

| BIT NUMBER | 31 | 30 | 29 | 28 | 27 | 26 | 25 | 24 | 23 | 22 | 21 | 20 | 19 | 18 | 17 | 16 |
|-------------|----|----|----|----|----|----|----|----|----|----|----|----|----|----|----|----|
| RESET STATE | X | 0 | 0 | 0 | 0 | 0 | 0 | 0 | X | X | X | X | X | X | X | X |

| BIT NUMBER | 15 | 14 | 13 | 12 | 11 | 10 | 9 | 8 | 7 | 6 | 5 | 4 | 3 | 2 | 1 | 0 |
|-------------|----|----|----|----|----|----|---|---|---|---|---|---|---|---|---|---|
| RESET STATE | 0 | 0 | 0 | 0 | 0 | 0 | 0 | 0 | 0 | 0 | 0 | 0 | 0 | 0 | 0 | 0 |

Table 8-12. Self-ID Count Register Description

| BIT | FIELD NAME | TYPE | Description |
|-------|------------------|------|---|
| 31 | selfIDError | RU | When bit 31 is set to 1b, an error was detected during the most recent self-ID packet reception. The contents of the self-ID buffer are undefined. This bit is cleared after a self-ID reception in which no errors are detected. Note that an error can be a hardware error or a host bus write error. |
| 30-24 | RSVD | R | Reserved. Bits 30-24 return 000 0000b when read. |
| 23-16 | selfIDGeneration | RU | The value in this field increments each time a bus reset is detected. This field rolls over to 0 after reaching 255. |
| 15-11 | RSVD | R | Reserved. Bits 15-11 return 00000b when read. |
| 10-2 | selfIDSize | RU | This field indicates the number of quadlets that have been written into the self-ID buffer for the current bits 23-16 (selfIDGeneration field). This includes the header quadlet and the self-ID data. This field is cleared to 0 0000 0000b when the self-ID reception begins. |
| 1-0 | RSVD | R | Reserved. Bits 1 and 0 return 00b when read. |

8.19 Isochronous Receive Channel Mask High Register

The isochronous receive channel mask high set/clear register enables packet receives from the upper 32 isochronous data channels. A read from either the set or clear register returns the content of the isochronous receive channel mask high register. See [Table 8-13](#) for a complete description of the register contents.

OHCI register offset: 70h set register
 74h clear register

Register type: Read/Set/Clear

Default value: XXXX XXXXh

| BIT NUMBER | 31 | 30 | 29 | 28 | 27 | 26 | 25 | 24 | 23 | 22 | 21 | 20 | 19 | 18 | 17 | 16 |
|-------------|----|----|----|----|----|----|----|----|----|----|----|----|----|----|----|----|
| RESET STATE | X | X | X | X | X | X | X | X | X | X | X | X | X | X | X | X |

| BIT NUMBER | 15 | 14 | 13 | 12 | 11 | 10 | 9 | 8 | 7 | 6 | 5 | 4 | 3 | 2 | 1 | 0 |
|-------------|----|----|----|----|----|----|---|---|---|---|---|---|---|---|---|---|
| RESET STATE | X | X | X | X | X | X | X | X | X | X | X | X | X | X | X | X |

Table 8-13. Isochronous Receive Channel Mask High Register Description

| BIT | FIELD NAME | TYPE | DESCRIPTION |
|-----|--------------|------|--|
| 31 | isoChannel63 | RSC | When bit 31 is set to 1b, the controller is enabled to receive from isochronous channel number 63. |
| 30 | isoChannel62 | RSC | When bit 30 is set to 1b, the controller is enabled to receive from isochronous channel number 62. |
| 29 | isoChannel61 | RSC | When bit 29 is set to 1b, the controller is enabled to receive from isochronous channel number 61. |
| 28 | isoChannel60 | RSC | When bit 28 is set to 1b, the controller is enabled to receive from isochronous channel number 60. |
| 27 | isoChannel59 | RSC | When bit 27 is set to 1b, the controller is enabled to receive from isochronous channel number 59. |
| 26 | isoChannel58 | RSC | When bit 26 is set to 1b, the controller is enabled to receive from isochronous channel number 58. |
| 25 | isoChannel57 | RSC | When bit 25 is set to 1b, the controller is enabled to receive from isochronous channel number 57. |
| 24 | isoChannel56 | RSC | When bit 24 is set to 1b, the controller is enabled to receive from isochronous channel number 56. |
| 23 | isoChannel55 | RSC | When bit 23 is set to 1b, the controller is enabled to receive from isochronous channel number 55. |
| 22 | isoChannel54 | RSC | When bit 22 is set to 1b, the controller is enabled to receive from isochronous channel number 54. |
| 21 | isoChannel53 | RSC | When bit 21 is set to 1b, the controller is enabled to receive from isochronous channel number 53. |
| 20 | isoChannel52 | RSC | When bit 20 is set to 1b, the controller is enabled to receive from isochronous channel number 52. |
| 19 | isoChannel51 | RSC | When bit 19 is set to 1b, the controller is enabled to receive from isochronous channel number 51. |
| 18 | isoChannel50 | RSC | When bit 18 is set to 1b, the controller is enabled to receive from isochronous channel number 50. |
| 17 | isoChannel49 | RSC | When bit 17 is set to 1b, the controller is enabled to receive from isochronous channel number 49. |
| 16 | isoChannel48 | RSC | When bit 16 is set to 1b, the controller is enabled to receive from isochronous channel number 48. |
| 15 | isoChannel47 | RSC | When bit 15 is set to 1b, the controller is enabled to receive from isochronous channel number 47. |
| 14 | isoChannel46 | RSC | When bit 14 is set to 1b, the controller is enabled to receive from isochronous channel number 46. |
| 13 | isoChannel45 | RSC | When bit 13 is set to 1b, the controller is enabled to receive from isochronous channel number 45. |
| 12 | isoChannel44 | RSC | When bit 12 is set to 1b, the controller is enabled to receive from isochronous channel number 44. |
| 11 | isoChannel43 | RSC | When bit 11 is set to 1b, the controller is enabled to receive from isochronous channel number 43. |
| 10 | isoChannel42 | RSC | When bit 10 is set to 1b, the controller is enabled to receive from isochronous channel number 42. |
| 9 | isoChannel41 | RSC | When bit 9 is set to 1b, the controller is enabled to receive from isochronous channel number 41. |
| 8 | isoChannel40 | RSC | When bit 8 is set to 1b, the controller is enabled to receive from isochronous channel number 40. |
| 7 | isoChannel39 | RSC | When bit 7 is set to 1b, the controller is enabled to receive from isochronous channel number 39. |
| 6 | isoChannel38 | RSC | When bit 6 is set to 1b, the controller is enabled to receive from isochronous channel number 38. |
| 5 | isoChannel37 | RSC | When bit 5 is set to 1b, the controller is enabled to receive from isochronous channel number 37. |
| 4 | isoChannel36 | RSC | When bit 4 is set to 1b, the controller is enabled to receive from isochronous channel number 36. |
| 3 | isoChannel35 | RSC | When bit 3 is set to 1b, the controller is enabled to receive from isochronous channel number 35. |
| 2 | isoChannel34 | RSC | When bit 2 is set to 1b, the controller is enabled to receive from isochronous channel number 34. |
| 1 | isoChannel33 | RSC | When bit 1 is set to 1b, the controller is enabled to receive from isochronous channel number 33. |
| 0 | isoChannel32 | RSC | When bit 0 is set to 1b, the controller is enabled to receive from isochronous channel number 32. |

8.20 Isochronous Receive Channel Mask Low Register

The isochronous receive channel mask low set/clear register enables packet receives from the lower 32 isochronous data channels. See [Table 8-14](#) for a complete description of the register contents.

OHCI register offset: 78h set register
 7Ch clear register

Register type: Read/Set/Clear

Default value: XXXX XXXXh

| BIT NUMBER | 31 | 30 | 29 | 28 | 27 | 26 | 25 | 24 | 23 | 22 | 21 | 20 | 19 | 18 | 17 | 16 |
|-------------|----|----|----|----|----|----|----|----|----|----|----|----|----|----|----|----|
| RESET STATE | X | X | X | X | X | X | X | X | X | X | X | X | X | X | X | X |

| BIT NUMBER | 15 | 14 | 13 | 12 | 11 | 10 | 9 | 8 | 7 | 6 | 5 | 4 | 3 | 2 | 1 | 0 |
|-------------|----|----|----|----|----|----|---|---|---|---|---|---|---|---|---|---|
| RESET STATE | X | X | X | X | X | X | X | X | X | X | X | X | X | X | X | X |

Table 8-14. Isochronous Receive Channel Mask Low Register Description

| BIT | FIELD NAME | TYPE | Description |
|------|--------------|------|--|
| 31 | isoChannel31 | RSC | When bit 31 is set to 1b, the controller is enabled to receive from isochronous channel number 31. |
| 30 | isoChannel30 | RSC | When bit 30 is set to 1b, the controller is enabled to receive from isochronous channel number 30. |
| 29-2 | isoChanneln | RSC | Bits 29 through 2 (isoChanneln, where n = 29, 28, 27, ..., 2) follow the same pattern as bits 31 and 30. |
| 1 | isoChannel1 | RSC | When bit 1 is set to 1b, the controller is enabled to receive from isochronous channel number 1. |
| 0 | isoChannel0 | RSC | When bit 0 is set to 1b, the controller is enabled to receive from isochronous channel number 0. |

8.21 Interrupt Event Register

The interrupt event set/clear register reflects the state of the various interrupt sources. The interrupt bits are set to 1b by an asserting edge of the corresponding interrupt signal or by writing a 1b in the corresponding bit in the set register. The only mechanism to clear a bit in this register is to write a 1b to the corresponding bit in the clear register.

This register is fully compliant with the *1394 Open Host Controller Interface Specification*, and the controller adds a vendor-specific interrupt function to bit 30. When the interrupt event register is read, the return value is the bit-wise AND function of the interrupt event and interrupt mask registers. See [Table 8-15](#) for a complete description of the register contents.

OHCI register offset: 80h set register
 84h clear register [returns the content of the interrupt event register
 bit-wise ANDed with the interrupt mask register when read]

Register type: Read/Set/Clear/Update, Read/Set/Clear, Read/Update, Read-only

Default value: XXXX 0XXXh

| BIT NUMBER | 31 | 30 | 29 | 28 | 27 | 26 | 25 | 24 | 23 | 22 | 21 | 20 | 19 | 18 | 17 | 16 |
|-------------|----|----|----|----|----|----|----|----|----|----|----|----|----|----|----|----|
| RESET STATE | 0 | X | 0 | 0 | 0 | X | X | X | X | X | X | X | X | 0 | X | X |

| BIT NUMBER | 15 | 14 | 13 | 12 | 11 | 10 | 9 | 8 | 7 | 6 | 5 | 4 | 3 | 2 | 1 | 0 |
|-------------|----|----|----|----|----|----|---|---|---|---|---|---|---|---|---|---|
| RESET STATE | 0 | 0 | 0 | 0 | 0 | 0 | X | X | X | X | X | X | X | X | X | X |

Table 8-15. Interrupt Event Register Description

| BIT | FIELD NAME | TYPE | DESCRIPTION |
|-----|----------------|------|---|
| 31 | RSVD | R | Reserved. Bit 31 returns 0b when read. |
| 30 | vendorSpecific | RSC | This vendor-specific interrupt event is reported when either of the general-purpose interrupts are asserted. The general-purpose interrupts are enabled by setting the corresponding bits INT_3EN and INT_2EN (bits 31 and 23, respectively) to 1 in the GPIO control register at offset FCh in the PCI configuration space |

Table 8-15. Interrupt Event Register Description (continued)

| BIT | FIELD NAME | TYPE | DESCRIPTION |
|-------|--------------------|------|--|
| 29 | SoftInterrupt | RSC | Bit 29 is used by software to generate an interrupt for its own use. |
| 28 | RSVD | R | Reserved. Bit 28 returns 0b when read. |
| 27 | ack_tardy | RSCU | Bit 27 is set to 1b when bit 29 (AckTardyEnable) in the host controller control register at OHCI offset 50h/54h (see Section 3.3.2) is set to 1b and any of the following conditions occur: <ol style="list-style-type: none"> Data is present in a receive FIFO that is to be delivered to the host. The physical response unit is busy processing requests or sending responses. The controller sent an ack_tardy acknowledgment. |
| 26 | phyRegRcvd | RSCU | The controller has received a PHY register data byte which can be read from bits 23-16 in the PHY layer control register at OHCI offset ECh (see Section 8.33). |
| 25 | cycleTooLong | RSCU | If bit 21 (cycleMaster) in the link control register at OHCI offset E0h/E4h (see Section 8.30) is set to 1b, then this indicates that over 125 μ s has elapsed between the start of sending a cycle start packet and the end of a subaction gap. Bit 21 (cycleMaster) in the link control register is cleared by this event. |
| 24 | unrecoverableError | RSCU | This event occurs when the controller encounters any error that forces it to stop operations on any or all of its subunits, for example, when a DMA context sets its dead bit to 1b. While bit 24 is set to 1b, all normal interrupts for the context(s) that caused this interrupt are blocked from being set to 1b. |
| 23 | cycleInconsistent | RSCU | A cycle start was received that had values for the cycleSeconds and cycleCount fields that are different from the values in bits 31-25 (cycleSeconds field) and bits 24-12 (cycleCount field) in the isochronous cycle timer register at OHCI offset F0h (see Section 8.34). |
| 22 | cycleLost | RSCU | A lost cycle is indicated when no cycle_start packet is sent or received between two successive cycleSynch events. A lost cycle can be predicted when a cycle_start packet does not immediately follow the first subaction gap after the cycleSynch event or if an arbitration reset gap is detected after a cycleSynch event without an intervening cycle start. Bit 22 may be set to 1b either when a lost cycle occurs or when logic predicts that one will occur. |
| 21 | cycle64Seconds | RSCU | Indicates that the seventh bit of the cycle second counter has changed. |
| 20 | cycleSynch | RSCU | Indicates that a new isochronous cycle has started. Bit 20 is set to 1b when the low-order bit of the cycle count toggles. |
| 19 | phy | RSCU | Indicates that the PHY layer requests an interrupt through a status transfer. |
| 18 | regAccessFail | RSCU | Indicates that a register access has failed due to a missing SCLK clock signal from the PHY layer. When a register access fails, bit 18 is set to 1b before the next register access. |
| 17 | busReset | RSCU | Indicates that the PHY layer has entered bus reset mode. |
| 16 | selfIDcomplete | RSCU | A self-ID packet stream has been received. It is generated at the end of the bus initialization process. Bit 16 is turned off simultaneously when bit 17 (busReset) is turned on. |
| 15 | selfIDcomplete2 | RSCU | Secondary indication of the end of a self-ID packet stream. Bit 15 is set to 1b by the controller when it sets bit 16 (selfIDcomplete), and retains the state, independent of bit 17 (busReset). |
| 14-10 | RSVD | R | Reserved. Bits 14-10 return 00000b when read. |
| 9 | lockRespErr | RSCU | Indicates that the controller sent a lock response for a lock request to a serial bus register, but did not receive an ack_complete. |
| 8 | postedWriteErr | RSCU | Indicates that a host bus error occurred while the controller was trying to write a 1394 write request, which had already been given an ack_complete, into system memory. |
| 7 | isochRx | RU | Isochronous receive DMA interrupt. Indicates that one or more isochronous receive contexts have generated an interrupt. This is not a latched event; it is the logical OR of all bits in the isochronous receive interrupt event register at OHCI offset A0h/A4h (see Section 8.25) and isochronous receive interrupt mask register at OHCI offset A8h/ACH (see Section 8.26). The isochronous receive interrupt event register indicates which contexts have been interrupted. |
| 6 | isochTx | RU | Isochronous transmit DMA interrupt. Indicates that one or more isochronous transmit contexts have generated an interrupt. This is not a latched event; it is the logical OR of all bits in the isochronous transmit interrupt event register at OHCI offset 90h/94h (see Section 8.23) and isochronous transmit interrupt mask register at OHCI offset 98h/9Ch (see Section 8.24). The isochronous transmit interrupt event register indicates which contexts have been interrupted. |
| 5 | RSPkt | RSCU | Indicates that a packet was sent to an asynchronous receive response context buffer and the descriptor xferStatus and resCount fields have been updated. |
| 4 | RQPkt | RSCU | Indicates that a packet was sent to an asynchronous receive request context buffer and the descriptor xferStatus and resCount fields have been updated. |
| 3 | ARRS | RSCU | Asynchronous receive response DMA interrupt. Bit 3 is conditionally set to 1b upon completion of an ARRS DMA context command descriptor. |

Table 8-15. Interrupt Event Register Description (continued)

| BIT | FIELD NAME | TYPE | DESCRIPTION |
|-----|----------------|------|---|
| 2 | ARRQ | RSCU | Asynchronous receive request DMA interrupt. Bit 2 is conditionally set to 1b upon completion of an ARRQ DMA context command descriptor. |
| 1 | respTxComplete | RSCU | Asynchronous response transmit DMA interrupt. Bit 1 is conditionally set to 1b upon completion of an ATRS DMA command. |
| 0 | reqTxCompleter | RSCU | Asynchronous request transmit DMA interrupt. Bit 0 is conditionally set to 1b upon completion of an ATRQ DMA command. |

8.22 Interrupt Mask Register

The interrupt mask set/clear register enables the various interrupt sources. Reads from either the set register or the clear register always return the contents of the interrupt mask register. In all cases except masterIntEnable (bit 31) and vendorSpecific (bit 30), the enables for each interrupt event align with the interrupt event register bits detailed in [Table 8-15](#).

This register is fully compliant with the *1394 Open Host Controller Interface Specification* and the controller adds an interrupt function to bit 30. See [Table 8-16](#) for a complete description of bits 31 and 30.

OHCI register offset: 88h set register
 8Ch clear register

Register type: Read/Set/Clear/Update, Read/Set/Clear, Read/Update, Read-only

Default value: XXXX 0XXXh

| BIT NUMBER | 31 | 30 | 29 | 28 | 27 | 26 | 25 | 24 | 23 | 22 | 21 | 20 | 19 | 18 | 17 | 16 |
|-------------|----|----|----|----|----|----|----|----|----|----|----|----|----|----|----|----|
| RESET STATE | X | X | 0 | 0 | 0 | X | X | X | X | X | X | X | X | 0 | X | X |

| BIT NUMBER | 15 | 14 | 13 | 12 | 11 | 10 | 9 | 8 | 7 | 6 | 5 | 4 | 3 | 2 | 1 | 0 |
|-------------|----|----|----|----|----|----|---|---|---|---|---|---|---|---|---|---|
| RESET STATE | 0 | 0 | 0 | 0 | 0 | 0 | X | X | X | X | X | X | X | X | X | X |

Table 8-16. Interrupt Mask Register Description

| BIT | FIELD NAME | TYPE | Description |
|-----|--------------------|------|--|
| 31 | masterIntEnable | RSCU | Master interrupt enable. If bit 31 is set to 1b, then external interrupts are generated in accordance with the interrupt mask register. If this bit is cleared, then external interrupts are not generated regardless of the interrupt mask register settings. |
| 30 | VendorSpecific | RSC | When this bit and bit 30 (vendorSpecific) in the interrupt event register at OHCI offset 80h/84h (see Section 8.21) are set to 11b, this vendor-specific interrupt mask enables interrupt generation. |
| 29 | SoftInterrupt | RSC | When this bit and bit 29 (SoftInterrupt) in the interrupt event register at OHCI offset 80h/84h (see Section 8.21) are set to 11b, this soft-interrupt mask enables interrupt generation. |
| 28 | RSVD | R | Reserved. Bit 28 returns 0b when read. |
| 27 | ack_tardy | RSC | When this bit and bit 27 (ack_tardy) in the interrupt event register at OHCI offset 80h/84h (see Section 8.21) are set to 11b, this acknowledge-tardy interrupt mask enables interrupt generation. |
| 26 | phyRegRcvd | RSC | When this bit and bit 26 (phyRegRcvd) in the interrupt event register at OHCI offset 80h/84h (see Section 8.21) are set to 11b, this PHY-register interrupt mask enables interrupt generation. |
| 25 | cycleTooLong | RSC | When this bit and bit 25 (cycleTooLong) in the interrupt event register at OHCI offset 80h/84h (see Section 8.21) are set to 11b, this cycle-too-long interrupt mask enables interrupt generation. |
| 24 | unrecoverableError | RSC | When this bit and bit 24 (unrecoverableError) in the interrupt event register at OHCI offset 80h/84h (see Section 8.21) are set to 11b, this unrecoverable-error interrupt mask enables interrupt generation. |
| 23 | cycleInconsistent | RSC | When this bit and bit 23 (cycleInconsistent) in the interrupt event register at OHCI offset 80h/84h (see Section 8.21) are set to 11b, this inconsistent-cycle interrupt mask enables interrupt generation. |
| 22 | cycleLost | RSC | When this bit and bit 22 (cycleLost) in the interrupt event register at OHCI offset 80h/84h (see Section 8.21) are set to 11b, this lost-cycle interrupt mask enables interrupt generation. |

Table 8-16. Interrupt Mask Register Description (continued)

| BIT | FIELD NAME | TYPE | Description |
|-------|-----------------|------|--|
| 21 | cycle64Seconds | RSC | When this bit and bit 21 (cycle64Seconds) in the interrupt event register at OHCI offset 80h/84h (see Section 8.21) are set to 11b, this 64-second-cycle interrupt mask enables interrupt generation. |
| 20 | cycleSynch | RSC | When this bit and bit 20 (cycleSynch) in the interrupt event register at OHCI offset 80h/84h (see Section 8.21) are set to 11b, this isochronous-cycle interrupt mask enables interrupt generation. |
| 19 | phy | RSC | When this bit and bit 19 (phy) in the interrupt event register at OHCI offset 80h/84h (see Section 8.21) are set to 11b, this PHY-status-transfer interrupt mask enables interrupt generation. |
| 18 | regAccessFail | RSC | When this bit and bit 18 (regAccessFail) in the interrupt event register at OHCI offset 80h/84h (see Section 8.21) are set to 11b, this register-access-failed interrupt mask enables interrupt generation. |
| 17 | busReset | RSC | When this bit and bit 17 (busReset) in the interrupt event register at OHCI offset 80h/84h (see Section 8.21) are set to 11b, this bus-reset interrupt mask enables interrupt generation. |
| 16 | selfIDcomplete | RSC | When this bit and bit 16 (selfIDcomplete) in the interrupt event register at OHCI offset 80h/84h (see Section 8.21) are set to 11b, this self-ID-complete interrupt mask enables interrupt generation. |
| 15 | selfIDcomplete2 | RSC | When this bit and bit 15 (selfIDcomplete2) in the interrupt event register at OHCI offset 80h/84h (see Section 8.21) are set to 11b, this second-self-ID-complete interrupt mask enables interrupt generation. |
| 14-10 | RSVD | R | Reserved. Bits 14-10 return 00000b when read. |
| 9 | lockRespErr | RSC | When this bit and bit 9 (lockRespErr) in the interrupt event register at OHCI offset 80h/84h (see Section 8.21) are set to 11b, this lock-response-error interrupt mask enables interrupt generation. |
| 8 | postedWriteErr | RSC | When this bit and bit 8 (postedWriteErr) in the interrupt event register at OHCI offset 80h/84h (see Section 8.21) are set to 11b, this posted-write-error interrupt mask enables interrupt generation. |
| 7 | isochRx | RSC | When this bit and bit 7 (isochRx) in the interrupt event register at OHCI offset 80h/84h (see Section 8.21) are set to 11b, this isochronous-receive-DMA interrupt mask enables interrupt generation. |
| 6 | isochTx | RSC | When this bit and bit 6 (isochTx) in the interrupt event register at OHCI offset 80h/84h (see Section 8.21) are set to 11b, this isochronous-transmit-DMA interrupt mask enables interrupt generation. |
| 5 | RSPkt | RSC | When this bit and bit 5 (RSPkt) in the interrupt event register at OHCI offset 80h/84h (see Section 8.21) are set to 11b, this receive-response-packet interrupt mask enables interrupt generation. |
| 4 | RQPkt | RSC | When this bit and bit 4 (RQPkt) in the interrupt event register at OHCI offset 80h/84h (see Section 8.21) are set to 11b, this receive-request-packet interrupt mask enables interrupt generation. |
| 3 | ARRS | RSC | When this bit and bit 3 (ARRS) in the interrupt event register at OHCI offset 80h/84h (see Section 8.21) are set to 11b, this asynchronous-receive-response-DMA interrupt mask enables interrupt generation. |
| 2 | ARRQ | RSC | When this bit and bit 2 (ARRQ) in the interrupt event register at OHCI offset 80h/84h (see Section 8.21) are set to 11b, this asynchronous-receive-request-DMA interrupt mask enables interrupt generation. |
| 1 | respTxComplete | RSC | When this bit and bit 1 (respTxComplete) in the interrupt event register at OHCI offset 80h/84h (see Section 8.21) are set to 11b, this response-transmit-complete interrupt mask enables interrupt generation. |
| 0 | reqTxComplete | RSC | When this bit and bit 0 (reqTxComplete) in the interrupt event register at OHCI offset 80h/84h (see Section 8.21) are set to 11b, this request-transmit-complete interrupt mask enables interrupt generation. |

8.23 Isochronous Transmit Interrupt Event Register

The isochronous transmit interrupt event set/clear register reflects the interrupt state of the isochronous transmit contexts. An interrupt is generated on behalf of an isochronous transmit context if an OUTPUT_LAST* command completes and its interrupt bits are set to 1. Upon determining that the isoTx (bit 6) interrupt has occurred in the interrupt event register at OHCI offset 80h/84h (see [Section 8.21](#)), software can check this register to determine which context(caused the interrupt. The interrupt bits are set to 1 by an asserting edge of the corresponding interrupt signal, or by writing a 1b in the corresponding bit in the set register. The only mechanism to clear a bit in this register is to write a 1b to the corresponding bit in the clear register. See [Table 8-17](#) for a complete description of the register contents.

OHCI register offset: 90h set register

94h clear register [returns the contents of the isochronous transmit interrupt event register bit-wise ANDed with the isochronous transmit interrupt mask register when read]

Register type: Read/Set/Clear, Read-only

Default value: 0000 00XXh

| BIT NUMBER | 31 | 30 | 29 | 28 | 27 | 26 | 25 | 24 | 23 | 22 | 21 | 20 | 19 | 18 | 17 | 16 |
|-------------|----|----|----|----|----|----|----|----|----|----|----|----|----|----|----|----|
| RESET STATE | 0 | 0 | 0 | 0 | 0 | 0 | 0 | 0 | 0 | 0 | 0 | 0 | 0 | 0 | 0 | 0 |

| BIT NUMBER | 15 | 14 | 13 | 12 | 11 | 10 | 9 | 8 | 7 | 6 | 5 | 4 | 3 | 2 | 1 | 0 |
|-------------|----|----|----|----|----|----|---|---|---|---|---|---|---|---|---|---|
| RESET STATE | 0 | 0 | 0 | 0 | 0 | 0 | 0 | 0 | X | X | X | X | X | X | X | X |

Table 8-17. Isochronous Transmit Interrupt Event Register Description

| BIT | FIELD NAME | TYPE | DESCRIPTION |
|------|------------|------|---|
| 31-8 | RSVD | R | Reserved. Bits 31-8 return 0000h when read. |
| 7 | isoXmit7 | RSC | Isochronous transmit context 7 caused the interrupt event register bit 6 (isoTx) interrupt. |
| 6 | isoXmit6 | RSC | Isochronous transmit context 6 caused the interrupt event register bit 6 (isoTx) interrupt. |
| 5 | isoXmit5 | RSC | Isochronous transmit context 5 caused the interrupt event register bit 6 (isoTx) interrupt. |
| 4 | isoXmit4 | RSC | Isochronous transmit context 4 caused the interrupt event register bit 6 (isoTx) interrupt. |
| 3 | isoXmit3 | RSC | Isochronous transmit context 3 caused the interrupt event register bit 6 (isoTx) interrupt. |
| 2 | isoXmit2 | RSC | Isochronous transmit context 2 caused the interrupt event register bit 6 (isoTx) interrupt. |
| 1 | isoXmit1 | RSC | Isochronous transmit context 1 caused the interrupt event register bit 6 (isoTx) interrupt. |
| 0 | isoXmit0 | RSC | Isochronous transmit context 0 caused the interrupt event register bit 6 (isoTx) interrupt. |

8.24 Isochronous Transmit Interrupt Mask Register

The isochronous transmit interrupt mask set/clear register enables the isoTx interrupt source on a per-channel basis. Reads from either the set register or the clear register always return the contents of the isochronous transmit interrupt mask register. In all cases the enables for each interrupt event align with the isochronous transmit interrupt event register bits detailed in [Table 8-17](#).

OHCI register offset: 98h set register
9Ch clear register

Register type: Read/Set/Clear, Read-only

Default value: 0000 00XX

| BIT NUMBER | 31 | 30 | 29 | 28 | 27 | 26 | 25 | 24 | 23 | 22 | 21 | 20 | 19 | 18 | 17 | 16 |
|-------------|----|----|----|----|----|----|----|----|----|----|----|----|----|----|----|----|
| RESET STATE | 0 | 0 | 0 | 0 | 0 | 0 | 0 | 0 | 0 | 0 | 0 | 0 | 0 | 0 | 0 | 0 |

| | | | | | | | | | | | | | | | | |
|--------------------|----|----|----|----|----|----|---|---|---|---|---|---|---|---|---|---|
| BIT NUMBER | 15 | 14 | 13 | 12 | 11 | 10 | 9 | 8 | 7 | 6 | 5 | 4 | 3 | 2 | 1 | 0 |
| RESET STATE | 0 | 0 | 0 | 0 | 0 | 0 | 0 | 0 | X | X | X | X | X | X | X | X |

8.25 Isochronous Receive Interrupt Event Register

The isochronous receive interrupt event set/clear register reflects the interrupt state of the isochronous receive contexts. An interrupt is generated on behalf of an isochronous receive context if an INPUT_* command completes and its interrupt bits are set to 1. Upon determining that the isochRx (bit 7) interrupt in the interrupt event register at OHCI offset 80h/84h (see [Section 8.21](#)) has occurred, software can check this register to determine which context(s) caused the interrupt. The interrupt bits are set to 1 by an asserting edge of the corresponding interrupt signal or by writing a 1b in the corresponding bit in the set register. The only mechanism to clear a bit in this register is to write a 1b to the corresponding bit in the clear register. See [Table 8-18](#) for a complete description of the register contents.

OHCI register offset: A0h set register

A4h clear register [returns the contents of isochronous receive interrupt event register bit-wise ANDed with the isochronous receive mask register when read]

Register type: Read/Set/Clear, Read-only

Default value: 0000 000Xh

| | | | | | | | | | | | | | | | | |
|--------------------|----|----|----|----|----|----|----|----|----|----|----|----|----|----|----|----|
| BIT NUMBER | 31 | 30 | 29 | 28 | 27 | 26 | 25 | 24 | 23 | 22 | 21 | 20 | 19 | 18 | 17 | 16 |
| RESET STATE | 0 | 0 | 0 | 0 | 0 | 0 | 0 | 0 | 0 | 0 | 0 | 0 | 0 | 0 | 0 | 0 |

| | | | | | | | | | | | | | | | | |
|--------------------|----|----|----|----|----|----|---|---|---|---|---|---|---|---|---|---|
| BIT NUMBER | 15 | 14 | 13 | 12 | 11 | 10 | 9 | 8 | 7 | 6 | 5 | 4 | 3 | 2 | 1 | 0 |
| RESET STATE | 0 | 0 | 0 | 0 | 0 | 0 | 0 | 0 | 0 | 0 | 0 | 0 | X | X | X | X |

Table 8-18. Isochronous Receive Interrupt Event Register Description

| BIT | FIELD NAME | TYPE | Description |
|------|------------|------|--|
| 31-4 | RSVD | R | Reserved. Bits 31-4 return 000 0000h when read. |
| 3 | isoRecv3 | RSC | Isochronous receive channel 3 caused the interrupt event register bit 7 (isochRx) interrupt. |
| 2 | isoRecv2 | RSC | Isochronous receive channel 2 caused the interrupt event register bit 7 (isochRx) interrupt. |
| 1 | isoRecv1 | RSC | Isochronous receive channel 1 caused the interrupt event register bit 7 (isochRx) interrupt. |
| 0 | isoRecv0 | RSC | Isochronous receive channel 0 caused the interrupt event register bit 7 (isochRx) interrupt. |

8.26 Isochronous Receive Interrupt Mask Register

The isochronous receive interrupt mask set/clear register enables the isochRx interrupt source on a per-channel basis. Reads from either the set register or the clear register always return the contents of the isochronous receive interrupt mask register. In all cases the enables for each interrupt event align with the isochronous receive interrupt event register bits detailed in [Table 8-18](#).

OHCI register offset: A8h set register
ACh clear register

Register type: Read/Set/Clear, Read-only

Default value: 0000 0000h

| | | | | | | | | | | | | | | | | |
|--------------------|----|----|----|----|----|----|----|----|----|----|----|----|----|----|----|----|
| BIT NUMBER | 31 | 30 | 29 | 28 | 27 | 26 | 25 | 24 | 23 | 22 | 21 | 20 | 19 | 18 | 17 | 16 |
| RESET STATE | 0 | 0 | 0 | 0 | 0 | 0 | 0 | 0 | 0 | 0 | 0 | 0 | 0 | 0 | 0 | 0 |

| | | | | | | | | | | | | | | | | |
|--------------------|----|----|----|----|----|----|---|---|---|---|---|---|---|---|---|---|
| BIT NUMBER | 15 | 14 | 13 | 12 | 11 | 10 | 9 | 8 | 7 | 6 | 5 | 4 | 3 | 2 | 1 | 0 |
| RESET STATE | 0 | 0 | 0 | 0 | 0 | 0 | 0 | 0 | 0 | 0 | 0 | 0 | 0 | 0 | 0 | 0 |

8.27 Initial Bandwidth Available Register

The initial bandwidth available register value is loaded into the corresponding bus management CSR register on a system (hardware) or software reset. See [Table 8-19](#) for a complete description of the register contents.

OHCI register offset: B0h
 Register type: Read-only, Read/Write
 Default value: 0000 1333h

| | | | | | | | | | | | | | | | | |
|--------------------|-----------|-----------|-----------|-----------|-----------|-----------|-----------|-----------|-----------|-----------|-----------|-----------|-----------|-----------|-----------|-----------|
| BIT NUMBER | 31 | 30 | 29 | 28 | 27 | 26 | 25 | 24 | 23 | 22 | 21 | 20 | 19 | 18 | 17 | 16 |
| RESET STATE | 0 | 0 | 0 | 0 | 0 | 0 | 0 | 0 | 0 | 0 | 0 | 0 | 0 | 0 | 0 | 0 |

| | | | | | | | | | | | | | | | | |
|--------------------|-----------|-----------|-----------|-----------|-----------|-----------|----------|----------|----------|----------|----------|----------|----------|----------|----------|----------|
| BIT NUMBER | 15 | 14 | 13 | 12 | 11 | 10 | 9 | 8 | 7 | 6 | 5 | 4 | 3 | 2 | 1 | 0 |
| RESET STATE | 0 | 0 | 0 | 1 | 0 | 0 | 1 | 1 | 0 | 0 | 1 | 1 | 0 | 0 | 1 | 1 |

Table 8-19. Initial Bandwidth Available Register Description

| BIT | FIELD NAME | TYPE | DESCRIPTION |
|-------|-----------------|------|--|
| 31-13 | RSVD | R | Reserved. Bits 31-13 return 000 0000 0000 0000 0000b when read. |
| 12-0 | InitBWAvailable | RW | This field is reset to 1333h on a system (hardware) or software reset, and is not affected by a 1394 bus reset. The value of this field is loaded into the BANDWIDTH_AVAILABLE CSR register upon a GRST, PERST, PRST, or a 1394 bus reset. |

8.28 Initial Channels Available High Register

The initial channels available high register value is loaded into the corresponding bus management CSR register on a system (hardware) or software reset. See [Table 8-20](#) for a complete description of the register contents.

OHCI register offset: B4h
 Register type: Read/Write
 Default value: FFFF FFFFh

| | | | | | | | | | | | | | | | | |
|--------------------|-----------|-----------|-----------|-----------|-----------|-----------|-----------|-----------|-----------|-----------|-----------|-----------|-----------|-----------|-----------|-----------|
| BIT NUMBER | 31 | 30 | 29 | 28 | 27 | 26 | 25 | 24 | 23 | 22 | 21 | 20 | 19 | 18 | 17 | 16 |
| RESET STATE | 1 | 1 | 1 | 1 | 1 | 1 | 1 | 1 | 1 | 1 | 1 | 1 | 1 | 1 | 1 | 1 |

| | | | | | | | | | | | | | | | | |
|--------------------|-----------|-----------|-----------|-----------|-----------|-----------|----------|----------|----------|----------|----------|----------|----------|----------|----------|----------|
| BIT NUMBER | 15 | 14 | 13 | 12 | 11 | 10 | 9 | 8 | 7 | 6 | 5 | 4 | 3 | 2 | 1 | 0 |
| RESET STATE | 1 | 1 | 1 | 1 | 1 | 1 | 1 | 1 | 1 | 1 | 1 | 1 | 1 | 1 | 1 | 1 |

Table 8-20. Initial Channels Available High Register Description

| BIT | FIELD NAME | TYPE | Description |
|------|-----------------|------|---|
| 31-0 | InitChanAvailHi | RW | This field is reset to FFFF_FFFFh on a system (hardware) or software reset, and is not affected by a 1394 bus reset. The value of this field is loaded into the CHANNELS_AVAILABLE_HI CSR register upon a GRST, PERST, PRST, or a 1394 bus reset. |

8.29 Initial Channels Available Low Register

The initial channels available low register value is loaded into the corresponding bus management CSR register on a system (hardware) or software reset. See [Table 8-21](#) for complete description of the register contents.

OHCI register offset: B8h
 Register type: Read/Write
 Default value: FFFF FFFFh

| | | | | | | | | | | | | | | | | |
|--------------------|-----------|-----------|-----------|-----------|-----------|-----------|-----------|-----------|-----------|-----------|-----------|-----------|-----------|-----------|-----------|-----------|
| BIT NUMBER | 31 | 30 | 29 | 28 | 27 | 26 | 25 | 24 | 23 | 22 | 21 | 20 | 19 | 18 | 17 | 16 |
| RESET STATE | 1 | 1 | 1 | 1 | 1 | 1 | 1 | 1 | 1 | 1 | 1 | 1 | 1 | 1 | 1 | 1 |
| BIT NUMBER | 15 | 14 | 13 | 12 | 11 | 10 | 9 | 8 | 7 | 6 | 5 | 4 | 3 | 2 | 1 | 0 |
| RESET STATE | 1 | 1 | 1 | 1 | 1 | 1 | 1 | 1 | 1 | 1 | 1 | 1 | 1 | 1 | 1 | 1 |

Table 8-21. Initial Channels Available Low Register Description

| BIT | FIELD NAME | TYPE | DESCRIPTION |
|------------|-------------------|-------------|---|
| 31-0 | InitChanAvailLo | RW | This field is reset to FFFF_FFFFh on a system (hardware) or software reset, and is not affected by a 1394 bus reset. The value of this field is loaded into the CHANNELS_AVAILABLE_LO CSR register upon a $\overline{\text{GRST}}$, $\overline{\text{PRST}}$, $\overline{\text{PRST}}$, or a 1394 bus reset. |

8.30 Fairness Control Register

The fairness control register provides a mechanism by which software can direct the host controller to transmit multiple asynchronous requests during a fairness interval. See [Table 8-22](#) for a complete description of the register contents.

OHCI register offset: DCh
 Register type: Read-only, Read/Write
 Default value: 0000 0000h

| | | | | | | | | | | | | | | | | |
|--------------------|-----------|-----------|-----------|-----------|-----------|-----------|-----------|-----------|-----------|-----------|-----------|-----------|-----------|-----------|-----------|-----------|
| BIT NUMBER | 31 | 30 | 29 | 28 | 27 | 26 | 25 | 24 | 23 | 22 | 21 | 20 | 19 | 18 | 17 | 16 |
| RESET STATE | 0 | 0 | 0 | 0 | 0 | 0 | 0 | 0 | 0 | 0 | 0 | 0 | 0 | 0 | 0 | 0 |
| BIT NUMBER | 15 | 14 | 13 | 12 | 11 | 10 | 9 | 8 | 7 | 6 | 5 | 4 | 3 | 2 | 1 | 0 |
| RESET STATE | 0 | 0 | 0 | 0 | 0 | 0 | 0 | 0 | 0 | 0 | 0 | 0 | 0 | 0 | 0 | 0 |

Table 8-22. Fairness Control Register Description

| BIT | FIELD NAME | TYPE | DESCRIPTION |
|------------|-------------------|-------------|--|
| 31-8 | RSVD | R | Reserved. Bits 31-8 return 00 0000h when read. |
| 7-0 | pri_req | RW | This field specifies the maximum number of priority arbitration requests for asynchronous request packets that the link is permitted to make of the PHY layer during a fairness interval. The default value for this field is 00h. |

8.32 Node Identification Register

The node identification register contains the address of the node on which the OHCI-Lynx. chip resides, and indicates the valid node number status. The 16-bit combination of the busNumber field (bits 15-6) and the NodeNumber field (bits 5-0) is referred to as the node ID. See [Table 8-24](#) for a complete description of the register contents.

OHCI register offset: E8h
Register type: Read/Write/Update, Read/Update, Read-only
Default value: 0000 FFXh

| | | | | | | | | | | | | | | | | |
|--------------------|-----------|-----------|-----------|-----------|-----------|-----------|-----------|-----------|-----------|-----------|-----------|-----------|-----------|-----------|-----------|-----------|
| BIT NUMBER | 31 | 30 | 29 | 28 | 27 | 26 | 25 | 24 | 23 | 22 | 21 | 20 | 19 | 18 | 17 | 16 |
| RESET STATE | 0 | 0 | 0 | 0 | 0 | 0 | 0 | 0 | 0 | 0 | 0 | 0 | 0 | 0 | 0 | 0 |

| | | | | | | | | | | | | | | | | |
|--------------------|-----------|-----------|-----------|-----------|-----------|-----------|----------|----------|----------|----------|----------|----------|----------|----------|----------|----------|
| BIT NUMBER | 15 | 14 | 13 | 12 | 11 | 10 | 9 | 8 | 7 | 6 | 5 | 4 | 3 | 2 | 1 | 0 |
| RESET STATE | 1 | 1 | 1 | 1 | 1 | 1 | 1 | 1 | 1 | 1 | X | X | X | X | X | X |

Table 8-24. Node Identification Register Description

| BIT | FIELD NAME | TYPE | DESCRIPTION |
|-------|------------|------|---|
| 31 | IDValid | RU | Bit 31 indicates whether or not the controller has a valid node number. It is cleared when a 1394 bus reset is detected and set to 1b when the controller receives a new node number from its PHY layer. |
| 30 | root | RU | Bit 30 is set to 1b during the bus reset process if the attached PHY layer is root. |
| 29-28 | RSVD | R | Reserved. Bits 29 and 28 return 00b when read. |
| 27 | CPS | RU | Bit 27 is set to 1b if the PHY layer is reporting that cable power status is OK. |
| 26-16 | RSVD | R | Reserved. Bits 26-16 return 000 0000 0000b when read. |
| 15-6 | busNumber | RWU | This field identifies the specific 1394 bus the controller belongs to when multiple 1394-compatible buses are connected via a bridge. The default value for this field is all 1s. |
| 5-0 | NodeNumber | RU | This field is the physical node number established by the PHY layer during self-identification. It is automatically set to the value received from the PHY layer after the self-identification phase. If the PHY layer sets the nodeNumber to 63, then software must not set bit 15 (run) in the asynchronous context control register (see Section 8.40) for either of the AT DMA contexts. |

8.33 PHY Layer Control Register

The PHY layer control register reads from or writes to a PHY register. See [Table 8-25](#) for a complete description of the register contents.

OHCI register offset: ECh
 Register type: Read/Write/Update, Read/Write, Read/Update, Read-only
 Default value: 0000 0000h

| | | | | | | | | | | | | | | | | |
|--------------------|-----------|-----------|-----------|-----------|-----------|-----------|-----------|-----------|-----------|-----------|-----------|-----------|-----------|-----------|-----------|-----------|
| BIT NUMBER | 31 | 30 | 29 | 28 | 27 | 26 | 25 | 24 | 23 | 22 | 21 | 20 | 19 | 18 | 17 | 16 |
| RESET STATE | 0 | 0 | 0 | 0 | 0 | 0 | 0 | 0 | 0 | 0 | 0 | 0 | 0 | 0 | 0 | 0 |

| | | | | | | | | | | | | | | | | |
|--------------------|-----------|-----------|-----------|-----------|-----------|-----------|----------|----------|----------|----------|----------|----------|----------|----------|----------|----------|
| BIT NUMBER | 15 | 14 | 13 | 12 | 11 | 10 | 9 | 8 | 7 | 6 | 5 | 4 | 3 | 2 | 1 | 0 |
| RESET STATE | 0 | 0 | 0 | 0 | 0 | 0 | 0 | 0 | 0 | 0 | 0 | 0 | 0 | 0 | 0 | 0 |

Table 8-25. PHY Control Register Description

| BIT | FIELD NAME | TYPE | DESCRIPTION |
|-------|------------|------|---|
| 31 | rdDone | RU | Bit 31 is cleared to 0b by the controller when either bit 15 (rdReg) or bit 14 (wrReg) is set to 1b. This bit is set to 1b when a register transfer is received from the PHY layer. |
| 30-28 | RSVD | R | Reserved. Bits 30-28 return 000b when read. |
| 27-24 | rdAddr | RU | This field is the address of the register most recently received from the PHY layer. |
| 23-16 | rdData | RU | This field is the contents of a PHY register that has been read. |
| 15 | rdReg | RWU | Bit 15 is set to 1b by software to initiate a read request to a PHY register, and is cleared by hardware when the request has been sent. Bits 14 (wrReg) and 15 (rdReg) must not both be set to 1b simultaneously. |
| 14 | wrReg | RWU | Bit 14 is set to 1b by software to initiate a write request to a PHY register, and is cleared by hardware when the request has been sent. Bits 14 (wrReg) and 15 (rdReg) must not both be set to 1b simultaneously. |
| 13-12 | RSVD | R | Reserved. Bits 13 and 12 return 00b when read. |
| 11:8 | regAddr | RW | This field is the address of the PHY register to be written or read. The default value for this field is 0h. |
| 7:0 | wrData | RW | This field is the data to be written to a PHY register and is ignored for reads. The default value for this field is 00h. |

8.34 Isochronous Cycle Timer Register

The isochronous cycle timer register indicates the current cycle number and offset. When the controller is cycle master, this register is transmitted with the cycle start message. When the controller is not cycle master, this register is loaded with the data field in an incoming cycle start. In the event that the cycle start message is not received, the fields can continue incrementing on their own (if programmed) to maintain a local time reference. See [Table 8-26](#) for a complete description of the register contents.

OHCI register offset: F0h
 Register type: Read/Write/Update
 Default value: XXXX XXXXh

| | | | | | | | | | | | | | | | | |
|--------------------|-----------|-----------|-----------|-----------|-----------|-----------|-----------|-----------|-----------|-----------|-----------|-----------|-----------|-----------|-----------|-----------|
| BIT NUMBER | 31 | 30 | 29 | 28 | 27 | 26 | 25 | 24 | 23 | 22 | 21 | 20 | 19 | 18 | 17 | 16 |
| RESET STATE | X | X | X | X | X | X | X | X | X | X | X | X | X | X | X | X |

| | | | | | | | | | | | | | | | | |
|--------------------|-----------|-----------|-----------|-----------|-----------|-----------|----------|----------|----------|----------|----------|----------|----------|----------|----------|----------|
| BIT NUMBER | 15 | 14 | 13 | 12 | 11 | 10 | 9 | 8 | 7 | 6 | 5 | 4 | 3 | 2 | 1 | 0 |
| RESET STATE | X | X | X | X | X | X | X | X | X | X | X | X | X | X | X | X |

Table 8-26. Isochronous Cycle Timer Register Description

| BIT | FIELD NAME | TYPE | DESCRIPTION |
|------------|-------------------|-------------|--|
| 31-25 | cycleSeconds | RWU | This field counts seconds [rollovers from bits 24-12 (cycleCount field)] modulo 128. |
| 24-12 | cycleCount | RWU | This field counts cycles [rollovers from bits 11-0 (cycleOffset field)] modulo 8000. |
| 11-0 | cycleOffset | RWU | This field counts 24.576-MHz clocks modulo 3072, that is, 125 μ s. If an external 8-kHz clock configuration is being used, then this field must be cleared to 000h at each tick of the external clock. |

8.35 Asynchronous Request Filter High Register

The asynchronous request filter high set/clear register enables asynchronous receive requests on a per-node basis, and handles the upper node IDs. When a packet is destined for either the physical request context or the ARRQ context, the source node ID is examined. If the bit corresponding to the node ID is not set to 1b in this register, then the packet is not acknowledged and the request is not queued. The node ID comparison is done if the source node is on the same bus as the controller. Nonlocal bus-sourced packets are not acknowledged unless bit 31 in this register is set to 1b. See [Table 8-27](#) for a complete description of the register contents.

OHCI register offset: 100h set register
 104 h clear register

Register type: Read/Set/Clear

Default value: 0000 0000h

| | | | | | | | | | | | | | | | | |
|--------------------|-----------|-----------|-----------|-----------|-----------|-----------|-----------|-----------|-----------|-----------|-----------|-----------|-----------|-----------|-----------|-----------|
| BIT NUMBER | 31 | 30 | 29 | 28 | 27 | 26 | 25 | 24 | 23 | 22 | 21 | 20 | 19 | 18 | 17 | 16 |
| RESET STATE | 0 | 0 | 0 | 0 | 0 | 0 | 0 | 0 | 0 | 0 | 0 | 0 | 0 | 0 | 0 | 0 |
| BIT NUMBER | 15 | 14 | 13 | 12 | 11 | 10 | 9 | 8 | 7 | 6 | 5 | 4 | 3 | 2 | 1 | 0 |
| RESET STATE | 0 | 0 | 0 | 0 | 0 | 0 | 0 | 0 | 0 | 0 | 0 | 0 | 0 | 0 | 0 | 0 |

Table 8-27. Asynchronous Request Filter High Register Description

| BIT | FIELD NAME | TYPE | DESCRIPTION |
|------------|-------------------|-------------|---|
| 31 | asynReqAllBuses | RSC | If bit 31 is set to 1b, then all asynchronous requests received by the controller from nonlocal bus nodes are accepted. |
| 30 | asynReqResource62 | RSC | If bit 30 is set to 1b for local bus node number 62, then asynchronous requests received by the controller from that node are accepted. |
| 29 | asynReqResource61 | RSC | If bit 29 is set to 1b for local bus node number 61, then asynchronous requests received by the controller from that node are accepted. |
| 28 | asynReqResource60 | RSC | If bit 28 is set to 1b for local bus node number 60, then asynchronous requests received by the controller from that node are accepted. |
| 27 | asynReqResource59 | RSC | If bit 27 is set to 1b for local bus node number 59, then asynchronous requests received by the controller from that node are accepted. |
| 26 | asynReqResource58 | RSC | If bit 26 is set to 1b for local bus node number 58, then asynchronous requests received by the controller from that node are accepted. |
| 25 | asynReqResource57 | RSC | If bit 25 is set to 1b for local bus node number 57, then asynchronous requests received by the controller from that node are accepted. |
| 24 | asynReqResource56 | RSC | If bit 24 is set to 1b for local bus node number 56, then asynchronous requests received by the controller from that node are accepted. |
| 23 | asynReqResource55 | RSC | If bit 23 is set to 1b for local bus node number 55, then asynchronous requests received by the controller from that node are accepted. |
| 22 | asynReqResource54 | RSC | If bit 22 is set to 1b for local bus node number 54, then asynchronous requests received by the controller from that node are accepted. |
| 21 | asynReqResource53 | RSC | If bit 21 is set to 1b for local bus node number 53, then asynchronous requests received by the controller from that node are accepted. |
| 20 | asynReqResource52 | RSC | If bit 20 is set to 1b for local bus node number 52, then asynchronous requests received by the controller from that node are accepted. |
| 19 | asynReqResource51 | RSC | If bit 19 is set to 1b for local bus node number 51, then asynchronous requests received by the controller from that node are accepted. |
| 18 | asynReqResource50 | RSC | If bit 18 is set to 1b for local bus node number 50, then asynchronous requests received by the controller from that node are accepted. |
| 17 | asynReqResource49 | RSC | If bit 17 is set to 1b for local bus node number 49, then asynchronous requests received by the controller from that node are accepted. |
| 16 | asynReqResource48 | RSC | If bit 16 is set to 1b for local bus node number 48, then asynchronous requests received by the controller from that node are accepted. |
| 15 | asynReqResource47 | RSC | If bit 15 is set to 1b for local bus node number 47, then asynchronous requests received by the controller from that node are accepted. |

Table 8-27. Asynchronous Request Filter High Register Description (continued)

| BIT | FIELD NAME | TYPE | DESCRIPTION |
|-----|-------------------|------|---|
| 14 | asynReqResource46 | RSC | If bit 14 is set to 1b for local bus node number 46, then asynchronous requests received by the controller from that node are accepted. |
| 13 | asynReqResource45 | RSC | If bit 13 is set to 1b for local bus node number 45, then asynchronous requests received by the controller from that node are accepted. |
| 12 | asynReqResource44 | RSC | If bit 12 is set to 1b for local bus node number 44, then asynchronous requests received by the controller from that node are accepted. |
| 11 | asynReqResource43 | RSC | If bit 11 is set to 1b for local bus node number 43, then asynchronous requests received by the controller from that node are accepted. |
| 10 | asynReqResource42 | RSC | If bit 10 is set to 1b for local bus node number 42, then asynchronous requests received by the controller from that node are accepted. |
| 9 | asynReqResource41 | RSC | If bit 9 is set to 1b for local bus node number 41, then asynchronous requests received by the controller from that node are accepted. |
| 8 | asynReqResource40 | RSC | If bit 8 is set to 1b for local bus node number 40, then asynchronous requests received by the controller from that node are accepted. |
| 7 | asynReqResource39 | RSC | If bit 7 is set to 1b for local bus node number 39, then asynchronous requests received by the controller from that node are accepted. |
| 6 | asynReqResource38 | RSC | If bit 6 is set to 1b for local bus node number 38, then asynchronous requests received by the controller from that node are accepted. |
| 5 | asynReqResource37 | RSC | If bit 5 is set to 1b for local bus node number 37, then asynchronous requests received by the controller from that node are accepted. |
| 4 | asynReqResource36 | RSC | If bit 4 is set to 1b for local bus node number 36, then asynchronous requests received by the controller from that node are accepted. |
| 3 | asynReqResource35 | RSC | If bit 3 is set to 1b for local bus node number 35, then asynchronous requests received by the controller from that node are accepted. |
| 2 | asynReqResource34 | RSC | If bit 2 is set to 1b for local bus node number 34, then asynchronous requests received by the controller from that node are accepted. |
| 1 | asynReqResource33 | RSC | If bit 1 is set to 1b for local bus node number 33, then asynchronous requests received by the controller from that node are accepted. |
| 0 | asynReqResource32 | RSC | If bit 0 is set to 1b for local bus node number 32, then asynchronous requests received by the controller from that node are accepted. |

8.36 Asynchronous Request Filter Low Register

The asynchronous request filter low set/clear register enables asynchronous receive requests on a per-node basis, and handles the lower node IDs. Other than filtering different node IDs, this register behaves identically to the asynchronous request filter high register. See [Table 8-28](#) for a complete description of the register contents.

OHCI register offset: 108h set register
 10Ch clear register

Register type: Read/Set/Clear

Default value: 0000 0000h

| | | | | | | | | | | | | | | | | |
|--------------------|-----------|-----------|-----------|-----------|-----------|-----------|-----------|-----------|-----------|-----------|-----------|-----------|-----------|-----------|-----------|-----------|
| BIT NUMBER | 31 | 30 | 29 | 28 | 27 | 26 | 25 | 24 | 23 | 22 | 21 | 20 | 19 | 18 | 17 | 16 |
| RESET STATE | 0 | 0 | 0 | 0 | 0 | 0 | 0 | 0 | 0 | 0 | 0 | 0 | 0 | 0 | 0 | 0 |
| BIT NUMBER | 15 | 14 | 13 | 12 | 11 | 10 | 9 | 8 | 7 | 6 | 5 | 4 | 3 | 2 | 1 | 0 |
| RESET STATE | 0 | 0 | 0 | 0 | 0 | 0 | 0 | 0 | 0 | 0 | 0 | 0 | 0 | 0 | 0 | 0 |

Table 8-28. Asynchronous Request Filter Low Register Description

| BIT | FIELD NAME | TYPE | DESCRIPTION |
|------------|-------------------|-------------|---|
| 31 | asynReqResource31 | RSC | If bit 31 is set to 1b for local bus node number 31, then asynchronous requests received by the controller from that node are accepted. |
| 30 | asynReqResource30 | RSC | If bit 30 is set to 1b for local bus node number 30, then asynchronous requests received by the controller from that node are accepted. |
| 29-2 | asynReqResourcen | RSC | Bits 29 through 2 (asynReqResourcen, where n = 29, 28, 27, ..., 2) follow the same pattern as bits 31 and 30. |
| 1 | asynReqResource1 | RSC | If bit 1 is set to 1b for local bus node number 1, then asynchronous requests received by the controller from that node are accepted. |
| 0 | asynReqResource0 | RSC | If bit 0 is set to 1b for local bus node number 0, then asynchronous requests received by the controller from that node are accepted. |

8.37 Physical Request Filter High Register

The physical request filter high set/clear register enables physical receive requests on a per-node basis, and handles the upper node IDs. When a packet is destined for the physical request context, and the node ID has been compared against the ARRQ registers, then the comparison is done again with this register. If the bit corresponding to the node ID is not set to 1b in this register, then the request is handled by the ARRQ context instead of the physical request context. The node ID comparison is done if the source node is on the same bus as the controller. Nonlocal bus-sourced packets are not acknowledged unless bit 31 in this register is set to 1b. See [Table 8-29](#) for a complete description of the register contents.

OHCI register offset: 110h set register
 114h clear register

Register type: Read/Set/Clear

Default value: 0000 0000h

| | | | | | | | | | | | | | | | | |
|--------------------|-----------|-----------|-----------|-----------|-----------|-----------|-----------|-----------|-----------|-----------|-----------|-----------|-----------|-----------|-----------|-----------|
| BIT NUMBER | 31 | 30 | 29 | 28 | 27 | 26 | 25 | 24 | 23 | 22 | 21 | 20 | 19 | 18 | 17 | 16 |
| RESET STATE | 0 | 0 | 0 | 0 | 0 | 0 | 0 | 0 | 0 | 0 | 0 | 0 | 0 | 0 | 0 | 0 |

| | | | | | | | | | | | | | | | | |
|--------------------|-----------|-----------|-----------|-----------|-----------|-----------|----------|----------|----------|----------|----------|----------|----------|----------|----------|----------|
| BIT NUMBER | 15 | 14 | 13 | 12 | 11 | 10 | 9 | 8 | 7 | 6 | 5 | 4 | 3 | 2 | 1 | 0 |
| RESET STATE | 0 | 0 | 0 | 0 | 0 | 0 | 0 | 0 | 0 | 0 | 0 | 0 | 0 | 0 | 0 | 0 |

Table 8-29. Physical Request Filter High Register Description

| BIT | FIELD NAME | TYPE | DESCRIPTION |
|------------|-------------------|-------------|---|
| 31 | physReqAllBusses | RSC | If bit 31 is set to 1b, then all asynchronous requests received by the controller from nonlocal bus nodes are accepted. Bit 31 is not cleared by a PRST. |
| 30 | physReqResource62 | RSC | If bit 30 is set to 1b for local bus node number 62, then physical requests received by the controller from that node are handled through the physical request context. |
| 29 | physReqResource61 | RSC | If bit 29 is set to 1b for local bus node number 61, then physical requests received by the controller from that node are handled through the physical request context. |
| 28 | physReqResource60 | RSC | If bit 28 is set to 1b for local bus node number 60, then physical requests received by the controller from that node are handled through the physical request context. |
| 27 | physReqResource59 | RSC | If bit 27 is set to 1b for local bus node number 59, then physical requests received by the controller from that node are handled through the physical request context. |
| 26 | physReqResource58 | RSC | If bit 26 is set to 1b for local bus node number 58, then physical requests received by the controller from that node are handled through the physical request context. |
| 25 | physReqResource57 | RSC | If bit 25 is set to 1b for local bus node number 57, then physical requests received by the controller from that node are handled through the physical request context. |
| 24 | physReqResource56 | RSC | If bit 24 is set to 1b for local bus node number 56, then physical requests received by the controller from that node are handled through the physical request context. |
| 23 | physReqResource55 | RSC | If bit 23 is set to 1b for local bus node number 55, then physical requests received by the controller from that node are handled through the physical request context. |
| 22 | physReqResource54 | RSC | If bit 22 is set to 1b for local bus node number 54, then physical requests received by the controller from that node are handled through the physical request context. |
| 21 | physReqResource53 | RSC | If bit 21 is set to 1b for local bus node number 53, then physical requests received by the controller from that node are handled through the physical request context. |
| 20 | physReqResource52 | RSC | If bit 20 is set to 1b for local bus node number 52, then physical requests received by the controller from that node are handled through the physical request context. |
| 19 | physReqResource51 | RSC | If bit 19 is set to 1b for local bus node number 51, then physical requests received by the controller from that node are handled through the physical request context. |
| 18 | physReqResource50 | RSC | If bit 18 is set to 1b for local bus node number 50, then physical requests received by the controller from that node are handled through the physical request context. |
| 17 | physReqResource49 | RSC | If bit 17 is set to 1b for local bus node number 49, then physical requests received by the controller from that node are handled through the physical request context. |
| 16 | physReqResource48 | RSC | If bit 16 is set to 1b for local bus node number 48, then physical requests received by the controller from that node are handled through the physical request context. |

Table 8-29. Physical Request Filter High Register Description (continued)

| BIT | FIELD NAME | TYPE | DESCRIPTION |
|-----|-------------------|------|---|
| 15 | physReqResource47 | RSC | If bit 15 is set to 1b for local bus node number 47, then physical requests received by the controller from that node are handled through the physical request context. |
| 14 | physReqResource46 | RSC | If bit 14 is set to 1b for local bus node number 46, then physical requests received by the controller from that node are handled through the physical request context. |
| 13 | physReqResource45 | RSC | If bit 13 is set to 1b for local bus node number 45, then physical requests received by the controller from that node are handled through the physical request context. |
| 12 | physReqResource44 | RSC | If bit 12 is set to 1b for local bus node number 44, then physical requests received by the controller from that node are handled through the physical request context. |
| 11 | physReqResource43 | RSC | If bit 11 is set to 1b for local bus node number 43, then physical requests received by the controller from that node are handled through the physical request context. |
| 10 | physReqResource42 | RSC | If bit 10 is set to 1b for local bus node number 42, then physical requests received by the controller from that node are handled through the physical request context. |
| 9 | physReqResource41 | RSC | If bit 9 is set to 1b for local bus node number 41, then physical requests received by the controller from that node are handled through the physical request context. |
| 8 | physReqResource40 | RSC | If bit 8 is set to 1b for local bus node number 40, then physical requests received by the controller from that node are handled through the physical request context. |
| 7 | physReqResource39 | RSC | If bit 7 is set to 1b for local bus node number 39, then physical requests received by the controller from that node are handled through the physical request context. |
| 6 | physReqResource38 | RSC | If bit 6 is set to 1b for local bus node number 38, then physical requests received by the controller from that node are handled through the physical request context. |
| 5 | physReqResource37 | RSC | If bit 5 is set to 1b for local bus node number 37, then physical requests received by the controller from that node are handled through the physical request context. |
| 4 | physReqResource36 | RSC | If bit 4 is set to 1b for local bus node number 36, then physical requests received by the controller from that node are handled through the physical request context. |
| 3 | physReqResource35 | RSC | If bit 3 is set to 1b for local bus node number 35, then physical requests received by the controller from that node are handled through the physical request context. |
| 2 | physReqResource34 | RSC | If bit 2 is set to 1b for local bus node number 34, then physical requests received by the controller from that node are handled through the physical request context. |
| 1 | physReqResource33 | RSC | If bit 1 is set to 1b for local bus node number 33, then physical requests received by the controller from that node are handled through the physical request context. |
| 0 | physReqResource32 | RSC | If bit 0 is set to 1b for local bus node number 32, then physical requests received by the controller from that node are handled through the physical request context. |

8.38 Physical Request Filter Low Register

The physical request filter low set/clear register enables physical receive requests on a per-node basis, and handles the lower node IDs. When a packet is destined for the physical request context, and the node ID has been compared against the asynchronous request filter registers, then the node ID comparison is done again with this register. If the bit corresponding to the node ID is not set to 1b in this register, then the request is handled by the asynchronous request context instead of the physical request context. See [Table 8-30](#) for a complete description of the register contents.

OHCI register offset: 118h set register
 11Ch clear register

Register type: Read/Set/Clear

Default value: 0000 0000h

| BIT NUMBER | 31 | 30 | 29 | 28 | 27 | 26 | 25 | 24 | 23 | 22 | 21 | 20 | 19 | 18 | 17 | 16 |
|-------------|----|----|----|----|----|----|----|----|----|----|----|----|----|----|----|----|
| RESET STATE | 0 | 0 | 0 | 0 | 0 | 0 | 0 | 0 | 0 | 0 | 0 | 0 | 0 | 0 | 0 | 0 |

| BIT NUMBER | 15 | 14 | 13 | 12 | 11 | 10 | 9 | 8 | 7 | 6 | 5 | 4 | 3 | 2 | 1 | 0 |
|-------------|----|----|----|----|----|----|---|---|---|---|---|---|---|---|---|---|
| RESET STATE | 0 | 0 | 0 | 0 | 0 | 0 | 0 | 0 | 0 | 0 | 0 | 0 | 0 | 0 | 0 | 0 |

Table 8-30. Physical Request Filter Low Register Description

| BIT | FIELD NAME | TYPE | DESCRIPTION |
|------|-------------------|------|---|
| 31 | physReqResource31 | RSC | If bit 31 is set to 1b for local bus node number 31, then physical requests received by the controller from that node are handled through the physical request context. |
| 30 | physReqResource30 | RSC | If bit 30 is set to 1b for local bus node number 30, then physical requests received by the controller from that node are handled through the physical request context. |
| 29-2 | physReqResourcen | RSC | Bits 29 through 2 (physReqResourcen, where n = 29, 28, 27, ..., 2) follow the same pattern as bits 31 and 30. |
| 1 | physReqResource1 | RSC | If bit 1 is set to 1b for local bus node number 1, then physical requests received by the controller from that node are handled through the physical request context. |
| 0 | physReqResource0 | RSC | If bit 0 is set to 1b for local bus node number 0, then physical requests received by the controller from that node are handled through the physical request context. |

8.39 Physical Upper Bound Register (Optional Register)

The physical upper bound register is an optional register and is not implemented. This register returns 0000 0000h when read.

OHCI register offset: 120h

Register type: Read-only

Default value: 0000 0000h

| BIT NUMBER | 31 | 30 | 29 | 28 | 27 | 26 | 25 | 24 | 23 | 22 | 21 | 20 | 19 | 18 | 17 | 16 |
|-------------|----|----|----|----|----|----|----|----|----|----|----|----|----|----|----|----|
| RESET STATE | 0 | 0 | 0 | 0 | 0 | 0 | 0 | 0 | 0 | 0 | 0 | 0 | 0 | 0 | 0 | 0 |

| BIT NUMBER | 15 | 14 | 13 | 12 | 11 | 10 | 9 | 8 | 7 | 6 | 5 | 4 | 3 | 2 | 1 | 0 |
|-------------|----|----|----|----|----|----|---|---|---|---|---|---|---|---|---|---|
| RESET STATE | 0 | 0 | 0 | 0 | 0 | 0 | 0 | 0 | 0 | 0 | 0 | 0 | 0 | 0 | 0 | 0 |

8.40 Asynchronous Context Control Register

The asynchronous context control set/clear register controls the state and indicates status of the DMA context. See [Table 8-31](#) for a complete description of the register contents.

| | | | |
|-----------------------|------|----------------|--------|
| OHCI register offset: | 180h | set register | [ATRQ] |
| | 184h | clear register | [ATRQ] |
| | 1A0h | set register | [ATRS] |
| | 1A4h | clear register | [ATRS] |
| | 1C0h | set register | [ARRQ] |
| | 1C4h | clear register | [ARRQ] |
| | 1E0h | set register | [ARRS] |
| | 1E4h | clear register | [ARRS] |

Register type: Read/Set/Clear/Update, Read/Set/Update, Read/Update, Read-only

Default value: 0000 X0XXh

| | | | | | | | | | | | | | | | | |
|--------------------|-----------|-----------|-----------|-----------|-----------|-----------|-----------|-----------|-----------|-----------|-----------|-----------|-----------|-----------|-----------|-----------|
| BIT NUMBER | 31 | 30 | 29 | 28 | 27 | 26 | 25 | 24 | 23 | 22 | 21 | 20 | 19 | 18 | 17 | 16 |
| RESET STATE | 0 | 0 | 0 | 0 | 0 | 0 | 0 | 0 | 0 | 0 | 0 | 0 | 0 | 0 | 0 | 0 |

| | | | | | | | | | | | | | | | | |
|--------------------|-----------|-----------|-----------|-----------|-----------|-----------|----------|----------|----------|----------|----------|----------|----------|----------|----------|----------|
| BIT NUMBER | 15 | 14 | 13 | 12 | 11 | 10 | 9 | 8 | 7 | 6 | 5 | 4 | 3 | 2 | 1 | 0 |
| RESET STATE | 0 | 0 | 0 | X | 0 | 0 | 0 | 0 | X | X | X | X | X | X | X | X |

Table 8-31. Asynchronous Context Control Register Description

| BIT | FIELD NAME | TYPE | DESCRIPTION |
|-------|------------|------|---|
| 31-16 | RSVD | R | Reserved. Bits 31-16 return 0000h when read. |
| 15 | run | RSCU | Bit 15 is set to 1b by software to enable descriptor processing for the context and cleared by software to stop descriptor processing. The controller changes this bit only on a system (hardware) or software reset. |
| 14-13 | RSVD | R | Reserved. Bits 14 and 13 return 00b when read. |
| 12 | wake | RSU | Software sets bit 12 to 1b to cause the controller to continue or resume descriptor processing. The controller clears this bit on every descriptor fetch. |
| 11 | dead | RU | The controller sets bit 11 to 1b when it encounters a fatal error, and clears the bit when software clears bit 15 (run). Asynchronous contexts supporting out-of-order pipelining provide unique ContextControl.dead functionality. See Section 7.7 in the <i>1394 Open Host Controller Interface Specification (Release 1.1)</i> for more information. |
| 10 | active | RU | The controller sets bit 10 to 1b when it is processing descriptors. |
| 9 | betaFrame | RU | Set to 1 when the PHY indicates that the received packet is sent in Beta format. A response to a request sent using Beta format also uses Beta format. |
| 8 | RSVD | R | Reserved. Bit 8 returns 0b when read. |
| 7-5 | spd | RU | This field indicates the speed at which a packet was received or transmitted and only contains meaningful information for receive contexts. This field is encoded as: 000 = 100M bits/s 001 = 200M bits/s 010 = 400M bits/s 011 = 800M bits/s All other values are reserved. |
| 4-0 | eventcode | RU | This field holds the acknowledge sent by the link core for this packet or an internally-generated error code if the packet was not transferred successfully. |

8.41 Asynchronous Context Command Pointer Register

The asynchronous context command pointer register contains a pointer to the address of the first descriptor block that the controller accesses when software enables the context by setting bit 15 (run) in the asynchronous context control register (see [Section 8.40](#)) to 1b. See [Table 8-32](#) for a complete description of the register contents.

OHCI register offset: 18Ch [ATRQ]
 1ACh [ATRS]
 1CCh [ARRQ]
 1ECh [ARRS]

Register type: Read/Write/Update

Default value: XXXX XXXXh

| | | | | | | | | | | | | | | | | |
|--------------------|-----------|-----------|-----------|-----------|-----------|-----------|-----------|-----------|-----------|-----------|-----------|-----------|-----------|-----------|-----------|-----------|
| BIT NUMBER | 31 | 30 | 29 | 28 | 27 | 26 | 25 | 24 | 23 | 22 | 21 | 20 | 19 | 18 | 17 | 16 |
| RESET STATE | X | X | X | X | X | X | X | X | X | X | X | X | X | X | X | X |

| | | | | | | | | | | | | | | | | |
|--------------------|-----------|-----------|-----------|-----------|-----------|-----------|----------|----------|----------|----------|----------|----------|----------|----------|----------|----------|
| BIT NUMBER | 15 | 14 | 13 | 12 | 11 | 10 | 9 | 8 | 7 | 6 | 5 | 4 | 3 | 2 | 1 | 0 |
| RESET STATE | X | X | X | X | X | X | X | X | X | X | X | X | X | X | X | X |

Table 8-32. Asynchronous Context Command Pointer Register Description

| BIT | FIELD NAME | TYPE | DESCRIPTION |
|------------|-------------------|-------------|--|
| 31-4 | descriptorAddress | RWU | Contains the upper 28 bits of the address of a 16-byte aligned descriptor block. |
| 3-0 | Z | RWU | Indicates the number of contiguous descriptors at the address pointed to by the descriptor address. If Z is 0h, then it indicates that the descriptorAddress field (bits 31-4) is not valid. |

8.42 Isochronous Transmit Context Control Register

The isochronous transmit context control set/clear register controls options, state, and status for the isochronous transmit DMA contexts. The *n* value in the following register addresses indicates the context number (*n* = 0, 1, 2, 3, ..., 7). See [Table 8-33](#) for a complete description of the register contents.

OHCI register offset: 200h + (16 * *n*) set register
 204h + (16 * *n*) clear register

Register type: Read/Set/Clear/Update, Read/Set/Clear, Read/Set/Update, Read/Update, Read-only

Default value: XXXX X0XXh

| BIT NUMBER | 31 | 30 | 29 | 28 | 27 | 26 | 25 | 24 | 23 | 22 | 21 | 20 | 19 | 18 | 17 | 16 |
|-------------|----|----|----|----|----|----|----|----|----|----|----|----|----|----|----|----|
| RESET STATE | X | X | X | X | X | X | X | X | X | X | X | X | X | X | X | X |

| BIT NUMBER | 15 | 14 | 13 | 12 | 11 | 10 | 9 | 8 | 7 | 6 | 5 | 4 | 3 | 2 | 1 | 0 |
|-------------|----|----|----|----|----|----|---|---|---|---|---|---|---|---|---|---|
| RESET STATE | 0 | 0 | 0 | X | 0 | 0 | 0 | 0 | X | X | X | X | X | X | X | X |

Table 8-33. Isochronous Transmit Context Control Register Description ⁽¹⁾

| BIT | FIELD NAME | TYPE | DESCRIPTION |
|-------|------------------|------|---|
| 31 | cycleMatchEnable | RSCU | When bit 31 is set to 1b, processing occurs such that the packet described by the context first descriptor block is transmitted in the cycle whose number is specified in the cycleMatch field (bits 30-16). The cycleMatch field (bits 30-16) must match the low-order two bits of cycleSeconds and the 13-bit cycleCount field in the cycle start packet that is sent or received immediately before isochronous transmission begins. Since the isochronous transmit DMA controller may work ahead, the processing of the first descriptor block may begin slightly in advance of the actual cycle in which the first packet is transmitted. The effects of this bit, however, are impacted by the values of other bits in this register and are explained in the <i>1394 Open Host Controller Interface Specification</i> . Once the context has become active, hardware clears this bit. |
| 30-16 | cycleMatch | RSC | This field contains a 15-bit value, corresponding to the low-order two bits of the isochronous cycle timer register at OHCI offset F0h (see Section 8.34) cycleSeconds field (bits 31-25) and the cycleCount field (bits 24-12). If bit 31 (cycleMatchEnable) is set to 1b, then this isochronous transmit DMA context becomes enabled for transmits when the low-order two bits of the isochronous cycle timer register at OHCI offset F0h cycleSeconds field (bits 31-25) and the cycleCount field (bits 24-12) value equal this field (cycleMatch) value. |
| 15 | run | RSC | Bit 15 is set to 1b by software to enable descriptor processing for the context and cleared by software to stop descriptor processing. The controller changes this bit only on a system (hardware) or software reset. |
| 14-13 | RSVD | R | Reserved. Bits 14 and 13 return 00b when read. |
| 12 | wake | RSU | Software sets bit 12 to 1b to cause the controller to continue or resume descriptor processing. The controller clears this bit on every descriptor fetch. |
| 11 | dead | RU | The controller sets bit 11 to 1b when it encounters a fatal error, and clears the bit when software clears bit 15 (run) to 0b. |
| 10 | active | RU | The controller sets bit 10 to 1b when it is processing descriptors. |
| 9-5 | RSVD | R | Reserved. Bits 9-5 return 00000b when read. |
| 4-0 | event code | RU | Following an OUTPUT_LAST* command, the error code is indicated in this field. Possible values are: ack_complete, evt_descriptor_read, evt_data_read, and evt_unknown. |

(1) On an overflow for each running context, the isochronous transmit DMA supports up to 7 cycle skips, when the following are true:

1. Bit 11 (dead) in either the isochronous transmit or receive context control register is set to 1b.
2. Bits 4-0 (eventcode field) in either the isochronous transmit or receive context control register are set to evt_timeout.
3. Bit 24 (unrecoverableError) in the interrupt event register at OHCI offset 80h/84h (see [Section 8.21](#)) is set to 1b.

8.43 Isochronous Transmit Context Command Pointer Register

The isochronous transmit context command pointer register contains a pointer to the address of the first descriptor block that the controller accesses when software enables an isochronous transmit context by setting bit 15 (run) in the isochronous transmit context control register (see [Section 8.42](#)) to 1b. The isochronous transmit DMA context command pointer can be read when a context is active. The n value in the following register addresses indicates the context number (n = 0, 1, 2, 3, ..., 7).

OHCI register offset: 20Ch + (16 * n)

Register type: Read-only

Default value: XXXX XXXXh

| BIT NUMBER | 31 | 30 | 29 | 28 | 27 | 26 | 25 | 24 | 23 | 22 | 21 | 20 | 19 | 18 | 17 | 16 |
|-------------|----|----|----|----|----|----|----|----|----|----|----|----|----|----|----|----|
| RESET STATE | X | X | X | X | X | X | X | X | X | X | X | X | X | X | X | X |

| BIT NUMBER | 15 | 14 | 13 | 12 | 11 | 10 | 9 | 8 | 7 | 6 | 5 | 4 | 3 | 2 | 1 | 0 |
|-------------|----|----|----|----|----|----|---|---|---|---|---|---|---|---|---|---|
| RESET STATE | X | X | X | X | X | X | X | X | X | X | X | X | X | X | X | X |

8.44 Isochronous Receive Context Control Register

The isochronous receive context control set/clear register controls options, state, and status for the isochronous receive DMA contexts. The n value in the following register addresses indicates the context number (n = 0, 1, 2, 3). See [Table 8-34](#) for a complete description of the register contents.

OHCI register offset: 400h + (32 * n) set register
404h + (32 * n) clear register

Register type: Read/Set/Clear/Update, Read/Set/Clear, Read/Set/Update, Read/Update, Read-only

Default value: XX00 X0XXh

| BIT NUMBER | 31 | 30 | 29 | 28 | 27 | 26 | 25 | 24 | 23 | 22 | 21 | 20 | 19 | 18 | 17 | 16 |
|-------------|----|----|----|----|----|----|----|----|----|----|----|----|----|----|----|----|
| RESET STATE | X | X | X | X | X | 0 | 0 | 0 | 0 | 0 | 0 | 0 | 0 | 0 | 0 | 0 |

| BIT NUMBER | 15 | 14 | 13 | 12 | 11 | 10 | 9 | 8 | 7 | 6 | 5 | 4 | 3 | 2 | 1 | 0 |
|-------------|----|----|----|----|----|----|---|---|---|---|---|---|---|---|---|---|
| RESET STATE | 0 | 0 | 0 | X | 0 | 0 | 0 | 0 | X | X | X | X | X | X | X | X |

Table 8-34. Isochronous Receive Context Control Register Description

| BIT | FIELD NAME | TYPE | DESCRIPTION |
|-----|------------------|------|---|
| 31 | bufferFill | RSC | When bit 31 is set to 1b, received packets are placed back-to-back to completely fill each receive buffer. When this bit is cleared, each received packet is placed in a single buffer. If bit 28 (multiChanMode) is set to 1b, then this bit must also be set to 1b. The value of this bit must not be changed while bit 10 (active) or bit 15 (run) is set to 1b. |
| 30 | isochHeader | RSC | When bit 30 is set to 1b, received isochronous packets include the complete 4-byte isochronous packet header seen by the link layer. The end of the packet is marked with a xferStatus in the first doublet, and a 16-bit timeStamp indicating the time of the most recently received (or sent) cycleStart packet. When this bit is cleared, the packet header is stripped from received isochronous packets. The packet header, if received, immediately precedes the packet payload. The value of this bit must not be changed while bit 10 (active) or bit 15 (run) is set to 1b. |
| 29 | cycleMatchEnable | RSCU | When bit 29 is set to 1b and the 13-bit cycleMatch field (bits 24-12) in the isochronous receive context match register (See Section 8.46) matches the 13-bit cycleCount field in the cycleStart packet, the context begins running. The effects of this bit, however, are impacted by the values of other bits in this register. Once the context has become active, hardware clears this bit. The value of this bit must not be changed while bit 10 (active) or bit 15 (run) is set to 1b. |

Table 8-34. Isochronous Receive Context Control Register Description (continued)

| BIT | FIELD NAME | TYPE | DESCRIPTION |
|-------|----------------|------|---|
| 28 | multiChanMode | RSC | When bit 28 is set to 1b, the corresponding isochronous receive DMA context receives packets for all isochronous channels enabled in the isochronous receive channel mask high register at OHCI offset 70h/74h (see Section 8.19) and isochronous receive channel mask low register at OHCI offset 78h/7Ch (see Section 8.20). The isochronous channel number specified in the isochronous receive context match register (see Section 8.46) is ignored. When this bit is cleared, the isochronous receive DMA context receives packets for the single channel specified in the isochronous receive context match register (see Section 8.46). Only one isochronous receive DMA context may use the isochronous receive channel mask registers (see Section 8.19 , and Section 8.20). If more than one isochronous receive context control register has this bit set, then the results are undefined. The value of this bit must not be changed while bit 10 (active) or bit 15 (run) is set to 1b. |
| 27 | dualBufferMode | RSC | When bit 27 is set to 1b, receive packets are separated into first and second payload and streamed independently to the firstBuffer series and secondBuffer series as described in Section 10.2.3 in the <i>1394 Open Host Controller Interface Specification</i> . Also, when bit 27 is set to 1b, both bits 28 (multiChanMode) and 31 (bufferFill) are cleared to 00b. The value of this bit does not change when either bit 10 (active) or bit 15 (run) is set to 1b. |
| 26-16 | RSVD | R | Reserved. Bits 26-16 return 000 0000 0000b when read. |
| 15 | run | RSCU | Bit 15 is set to 1b by software to enable descriptor processing for the context and cleared by software to stop descriptor processing. The controller changes this bit only on a system (hardware) or software reset. |
| 14-13 | RSVD | R | Reserved. Bits 14 and 13 return 00b when read. |
| 12 | wake | RSU | Software sets bit 12 to 1b to cause the controller to continue or resume descriptor processing. The controller clears this bit on every descriptor fetch. |
| 11 | dead | RU | The controller sets bit 11 to 1b when it encounters a fatal error, and clears the bit when software clears bit 15 (run). |
| 10 | active | RU | The controller sets bit 10 to 1b when it is processing descriptors. |
| 9 | betaFrame | RU | Set to 1 when the PHY indicates that the received packet is sent in Beta format. A response to a request sent using Beta format also uses Beta format. |
| 9-8 | RSVD | R | Reserved. Bit 8 returns 0b when read. |
| 7-8 | spd | RU | This field indicates the speed at which the packet was received. 000 = 100M bits/s 001 = 200M bits/s 010 = 400M bits/s 011 = 800M bits/s All other values are reserved. |
| 4-0 | event code | RU | For bufferFill mode, possible values are: ack_complete, evt_descriptor_read, evt_data_write, and evt_unknown. Packets with data errors (either dataLength mismatches or dataCRC errors) and packets for which a FIFO overrun occurred are backed out. For packet-per-buffer mode, possible values are: ack_complete, ack_data_error, evt_long_packet, evt_overrun, evt_descriptor_read, evt_data_write, and evt_unknown. |

8.45 Isochronous Receive Context Command Pointer Register

The isochronous receive context command pointer register contains a pointer to the address of the first descriptor block that the controller accesses when software enables an isochronous receive context by setting bit 15 (run) in the isochronous receive context control register (see [Section 8.44](#)) to 1b. The n value in the following register addresses indicates the context number (n = 0, 1, 2, 3).

OHCI register offset: 40Ch + (32 * n)
 Register type: Read-oly
 Default value: XXXX XXXXh

| BIT NUMBER | 31 | 30 | 29 | 28 | 27 | 26 | 25 | 24 | 23 | 22 | 21 | 20 | 19 | 18 | 17 | 16 |
|-------------|----|----|----|----|----|----|----|----|----|----|----|----|----|----|----|----|
| RESET STATE | X | X | X | X | X | X | X | X | X | X | X | X | X | X | X | X |

| | | | | | | | | | | | | | | | | |
|--------------------|-----------|-----------|-----------|-----------|-----------|-----------|----------|----------|----------|----------|----------|----------|----------|----------|----------|----------|
| BIT NUMBER | 15 | 14 | 13 | 12 | 11 | 10 | 9 | 8 | 7 | 6 | 5 | 4 | 3 | 2 | 1 | 0 |
| RESET STATE | X | X | X | X | X | X | X | X | X | X | X | X | X | X | X | X |

8.46 Isochronous Receive Context Match Register

The isochronous receive context match register starts an isochronous receive context running on a specified cycle number, filters incoming isochronous packets based on tag values, and waits for packets with a specified sync value. The n value in the following register addresses indicates the context number (n = 0, 1, 2, 3). See [Table 8-35](#) for a complete description of the register contents.

OHCI register offset: 410h + (32 * n)
Register type: Read/Write, Read-only
Default value: XXXX XXXXh

| | | | | | | | | | | | | | | | | |
|--------------------|-----------|-----------|-----------|-----------|-----------|-----------|-----------|-----------|-----------|-----------|-----------|-----------|-----------|-----------|-----------|-----------|
| BIT NUMBER | 31 | 30 | 29 | 28 | 27 | 26 | 25 | 24 | 23 | 22 | 21 | 20 | 19 | 18 | 17 | 16 |
| RESET STATE | X | X | X | X | 0 | 0 | 0 | X | X | X | X | X | X | X | X | X |

| | | | | | | | | | | | | | | | | |
|--------------------|-----------|-----------|-----------|-----------|-----------|-----------|----------|----------|----------|----------|----------|----------|----------|----------|----------|----------|
| BIT NUMBER | 15 | 14 | 13 | 12 | 11 | 10 | 9 | 8 | 7 | 6 | 5 | 4 | 3 | 2 | 1 | 0 |
| RESET STATE | X | X | X | X | X | X | X | X | X | X | X | X | X | X | X | X |

Table 8-35. Isochronous Receive Context Match Register Description

| BIT | FIELD NAME | TYPE | DESCRIPTION |
|-------|----------------|------|---|
| 31 | tag3 | RW | If bit 31 is set to 1b, then this context matches on isochronous receive packets with a tag field of 11b. |
| 30 | tag2 | RW | If bit 30 is set to 1b, then this context matches on isochronous receive packets with a tag field of 10b. |
| 29 | tag1 | RW | If bit 29 is set to 1b, then this context matches on isochronous receive packets with a tag field of 01b. |
| 28 | tag0 | RW | If bit 28 is set to 1b, then this context matches on isochronous receive packets with a tag field of 00b. |
| 27 | RSVD | R | Reserved. Bit 27 returns 0b when read. |
| 26-12 | cycleMatch | RW | This field contains a 15-bit value corresponding to the two low-order bits of cycleSeconds and the 13-bit cycleCount field in the cycleStart packet. If cycleMatchEnable (bit 29) in the isochronous receive context control register (see Section 8.44) is set to 1b, then this context is enabled for receives when the two low-order bits of the isochronous cycle timer register at OHCI offset F0h (see Section 8.34) cycleSeconds field (bits 31-25) and cycleCount field (bits 24-12) value equal this field (cycleMatch) value. |
| 11-8 | sync | RW | This 4-bit field is compared to the sync field of each isochronous packet for this channel when the command descriptor w field is set to 11b. |
| 7 | RSVD | R | Reserved. Bit 7 returns 0b when read. |
| 6 | tag1SyncFilter | RW | If bit 6 and bit 29 (tag1) are set to 11b, then packets with tag 01b are accepted into the context if the two most significant bits of the packet sync field are 00b. Packets with tag values other than 01b are filtered according to bit 28 (tag0), bit 30 (tag2), and bit 31 (tag3) without any additional restrictions. If this bit is cleared, then this context matches on isochronous receive packets as specified in bits 28-31 (tag0-tag3) with no additional restrictions. |
| 5-0 | channelNumber | RW | This 6-bit field indicates the isochronous channel number for which this isochronous receive DMA context accepts packets. |

9 1394 OHCI Memory-Mapped TI Extension Register Space

The TI extension base address register provides a method of accessing memory-mapped TI extension registers. See [Section 7.9](#), *TI Extension Base Address Register*, for register bit field details. See [Table 9-1](#) for the TI extension register listing.

Table 9-1. TI Extension Register Map

| REGISTER NAME | OFFSET |
|---|-----------|
| Reserved | 00h-A7Fh |
| Isochronous Receive DV Enhancement Set | A80h |
| Isochronous Receive DV Enhancement Clear | A84h |
| Link Enhancement Control Set | A88h |
| Link Enhancement Control Clear | A8Ch |
| Isochronous Transmit Context 0 Timestamp Offset | A90h |
| Isochronous Transmit Context 1 Timestamp Offset | A94h |
| Isochronous Transmit Context 2 Timestamp Offset | A98h |
| Isochronous Transmit Context 3 Timestamp Offset | A9Ch |
| Isochronous Transmit Context 4 Timestamp Offset | AA0h |
| Isochronous Transmit Context 5 Timestamp Offset | AA4h |
| Isochronous Transmit Context 6 Timestamp Offset | AA8h |
| Isochronous Transmit Context 7 Timestamp Offset | AACH |
| Reserved | AB0h-FFFh |

9.1 DV and MPEG2 Timestamp Enhancements

The DV timestamp enhancements are enabled by bit 8 (`enab_dv_ts`) in the link enhancement control register located at PCI offset F4h and are aliased in TI extension register space at offset A88h (set) and A8Ch (clear).

The DV and MPEG transmit enhancements are enabled separately by bits in the link enhancement control register located in PCI configuration space at PCI offset F4h. The link enhancement control register is also aliased as a set/clear register in TI extension space at offset A88h (set) and A8Ch (clear).

Bit 8 (`enab_dv_ts`) of the link enhancement control register enables DV timestamp support. When enabled, the link calculates a timestamp based on the cycle timer and the timestamp offset register and substitutes it in the SYT field of the CIP once per DV frame.

Bit 10 (`enab_mpeg_ts`) of the link enhancement control register enables MPEG timestamp support. Two MPEG time stamp modes are supported. The default mode calculates an initial delta that is added to the calculated timestamp in addition to a user-defined offset. The initial offset is calculated as the difference in the intended transmit cycle count and the cycle count field of the timestamp in the first TSP of the MPEG2 stream. The use of the initial delta can be controlled by bit 31 (`DisableInitialOffset`) in the timestamp offset register (see [Section 9.5](#)).

The MPEG2 timestamp enhancements are enabled by bit 10 (`enab_mpeg_ts`) in the link enhancement control register located at PCI offset F4h and aliased in TI extension register space at offset A88h (set) and A8Ch (clear).

When bit 10 (`enab_mpeg_ts`) is set to 1b, the hardware applies the timestamp enhancements to isochronous transmit packets that have the tag field equal to 01b in the isochronous packet header and a FMT field equal to 10h.

9.2 Isochronous Receive Digital Video Enhancements

The DV frame sync and branch enhancement provides a mechanism in buffer-fill mode to synchronize 1394 DV data that is received in the correct order to DV frame-sized data buffers described by several

INPUT_MORE descriptors (see *1394 Open Host Controller Interface Specification*, Release 1.1). This is accomplished by waiting for the start-of-frame packet in a DV stream before transferring the received isochronous stream into the memory buffer described by the INPUT_MORE descriptors. This can improve the DV capture application performance by reducing the amount of processing overhead required to strip the CIP header and copy the received packets into frame-sized buffers.

The start of a DV frame is represented in the 1394 packet as a 16-bit pattern of 1FX7h (first byte 1Fh and second byte X7h) received as the first two bytes of the third quadlet in a DV isochronous packet.

9.3 Isochronous Receive Digital Video Enhancements Register

The isochronous receive digital video enhancements register enables the DV enhancements in the controller. The bits in this register may only be modified when both the active (bit 10) and run (bit 15) bits of the corresponding context control register are 00b. See [Table 9-2](#) for a complete description of the register contents.

TI extension register offset: A80h set register
 A84h clear register

Register type: Read/Set/Clear, Read-only

Default value: 0000 0000h

| | | | | | | | | | | | | | | | | |
|--------------------|-----------|-----------|-----------|-----------|-----------|-----------|-----------|-----------|-----------|-----------|-----------|-----------|-----------|-----------|-----------|-----------|
| BIT NUMBER | 31 | 30 | 29 | 28 | 27 | 26 | 25 | 24 | 23 | 22 | 21 | 20 | 19 | 18 | 17 | 16 |
| RESET STATE | 0 | 0 | 0 | 0 | 0 | 0 | 0 | 0 | 0 | 0 | 0 | 0 | 0 | 0 | 0 | 0 |

| | | | | | | | | | | | | | | | | |
|--------------------|-----------|-----------|-----------|-----------|-----------|-----------|----------|----------|----------|----------|----------|----------|----------|----------|----------|----------|
| BIT NUMBER | 15 | 14 | 13 | 12 | 11 | 10 | 9 | 8 | 7 | 6 | 5 | 4 | 3 | 2 | 1 | 0 |
| RESET STATE | 0 | 0 | 0 | 0 | 0 | 0 | 0 | 0 | 0 | 0 | 0 | 0 | 0 | 0 | 0 | 0 |

Table 9-2. Isochronous Receive Digital Video Enhancements Register Description

| BIT | FIELD NAME | TYPE | DESCRIPTION |
|-------|------------|------|---|
| 31-14 | RSVD | R | Reserved. Bits 31-14 return 00 0000 0000 0000 0000b when read. |
| 13 | DV_Branch3 | RSC | When bit 13 is set to 1b, the isochronous receive context 3 synchronizes reception to the DV frame start tag in bufferfill mode if input_more.b = 01b, and jumps to the descriptor pointed to by frameBranch if a DV frame start tag is received out of place. This bit is only interpreted when bit 12 (CIP_Strip3) is set to 1b and bit 30 (isochHeader) in the isochronous receive context control register at OHCI offset 460h/464h (see Section 8.44) is cleared to 0b. |
| 12 | CIP_Strip3 | RSC | When bit 12 is set to 1b, the isochronous receive context 3 strips the first two quadlets of payload. This bit is only interpreted when bit 30 (isochHeader) in the isochronous receive context control register at OHCI offset 460h/464h (see Section 8.44) is cleared to 0b. |
| 11-10 | RSVD | R | Reserved. Bits 11 and 10 return 00b when read. |
| 9 | DV_Branch2 | RSC | When bit 9 is set to 1b, the isochronous receive context 2 synchronizes reception to the DV frame start tag in bufferfill mode if input_more.b = 01b, and jumps to the descriptor pointed to by frameBranch if a DV frame start tag is received out of place. This bit is only interpreted when bit 8 (CIP_Strip2) is set to 1b and bit 30 (isochHeader) in the isochronous receive context control register at OHCI offset 440h/444h (see Section 8.44) is cleared to 0b. |
| 8 | CIP_Strip2 | RSC | When bit 8 is set to 1b, the isochronous receive context 2 strips the first two quadlets of payload. This bit is only interpreted when bit 30 (isochHeader) in the isochronous receive context control register at OHCI offset 440h/444h (see Section 8.44) is cleared to 0b. |
| 7-6 | RSVD | R | Reserved. Bits 7 and 6 return 00b when read. |
| 5 | DV_Branch1 | TSC | When bit 5 is set to 1b, the isochronous receive context 1 synchronizes reception to the DV frame start tag in bufferfill mode if input_more.b = 01b, and jumps to the descriptor pointed to by frameBranch if a DV frame start tag is received out of place. This bit is only interpreted when bit 4 (CIP_Strip1) is set to 1b and bit 30 (isochHeader) in the isochronous receive context control register at OHCI offset 420h/424h (see Section 8.44) is cleared to 0b. |
| 4 | CIP_Strip1 | RSC | When bit 4 is set to 1b, the isochronous receive context 1 strips the first two quadlets of payload. This bit is only interpreted when bit 30 (isochHeader) in the isochronous receive context control register at OHCI offset 420h/424h (see Section 8.44) is cleared to 0b. |
| 3-2 | RSVD | R | Reserved. Bits 3 and 2 return 00b when read. |

Table 9-3. Link Enhancement Register Description (continued)

| BIT | FIELD NAME | TYPE | DESCRIPTION |
|----------------------|------------------|------|--|
| 13-12 ⁽¹⁾ | atx_thresh | RW | <p>This field sets the initial AT threshold value, which is used until the AT FIFO is underrun. When the OHCI controller retries the packet, it uses a 2K-byte threshold, resulting in a store-and-forward operation.</p> <p>00 = Threshold ~ 2K bytes resulting in a store-and-forward operation 01 = Threshold ~ 1.7K bytes (default) 10 = Threshold ~ 1K bytes 11 = Threshold ~ 512 bytes</p> <p>These bits fine-tune the asynchronous transmit threshold. For most applications the 1.7K-byte threshold is optimal. Changing this value may increase or decrease the 1394 latency depending on the average PCI bus latency.</p> <p>Setting the AT threshold to 1.7K, 1K, or 512 bytes results in data being transmitted at these thresholds or when an entire packet has been checked into the FIFO. If the packet to be transmitted is larger than the AT threshold, then the remaining data must be received before the AT FIFO is emptied; otherwise, an underrun condition occurs, resulting in a packet error at the receiving node. As a result, the link then commences store-and-forward operation. Wait until it has the complete packet in the FIFO before retransmitting it on the second attempt to ensure delivery.</p> <p>An AT threshold of 2K results in store-and-forward operation, which means that asynchronous data will not be transmitted until an end-of-packet token is received. Restated, setting the AT threshold to 2K results in only complete packets being transmitted.</p> <p>Note that the OHCI controller will always use store-and-forward when the asynchronous transmit retries register at OHCI offset 08h (see Section 8.3, Asynchronous Transmit Retries Register) is cleared.</p> |
| 11 | RSVD | R | Reserved. Bit 11 returns 0b when read. |
| 10 ⁽¹⁾ | enab_mpeg_ts | RW | Enable MPEG Timestamp Enhancement. When this bit is set, Cheetah- Express shall apply time stamp enhancements to isochronous transmit packets that have the tag field equal to 2'b01 in the isochronous packet header and a FMT field equal to 6'h10. |
| 9 | RSVD | R | Reserved. Bit 9 returns 0b when read. |
| 8 ⁽¹⁾ | enab_dv_ts | RW | Enable DV CIP timestamp enhancement. When bit 8 is set to 1b, the enhancement is enabled for DV CIP transmit streams (FMT = 00h). The default value for this bit is 0b. |
| 7 ⁽¹⁾ | enab_unfair | RW | Enable asynchronous priority requests. OHCI-Lynx™ compatible. Setting bit 7 to 1b enables the link to respond to requests with priority arbitration. It is recommended that this bit be set to 1b. The default value for this bit is 0b. |
| 6-3 | RSVD | R | Reserved. Bits 6-3 return 0h when read. |
| 2 ⁽¹⁾ | enab_insert_idle | RW | Enable insert idle. OHCI-Lynx compatible. When the PHY has control of the Ct[0:1] internal control lines and D[0:8] internal data lines and the link requests control, the PHY drives 11b on the Ct[0:1] lines. The link can then start driving these lines immediately. Setting this bit to 1 inserts an idle state, so the link waits one clock cycle before it starts driving the lines (turnaround time). It is recommended that this bit be set to 1. For use with T1 phys this bit should be set to 0. If a serial EEPROM is implemented this bit is initialized with the value of EEPROM word 0x05 bit 2. |
| 1 ⁽¹⁾ | enab_accel | RW | Enable acceleration enhancements. OHCI-Lynx™ compatible. When bit 1 is set to 1b, the PHY layer is notified that the link supports the IEEE Std 1394a-2000 acceleration enhancements, that is, ack-accelerated, fly-by concatenation, etc. It is recommended that this bit be set to 1b. The default value for this bit is 0b. |
| 0 | RSVD | R | Reserved. Bit 0 returns 0b when read. |

9.5 Timestamp Offset Register

The value of this register is added as an offset to the cycle timer value when using the MPEG, DV, and CIP enhancements. A timestamp offset register is implemented per isochronous transmit context. The n value following the offset indicates the context number ($n = 0, 1, 2, 3, \dots, 7$). These registers are programmed by software as appropriate. See [Table 9-4](#) for a complete description of the register contents.

TI extension register offset: $A90h + (4*n)$
 Register type: Read/Write, Read-only
 Default value: 0000 0000h

| | | | | | | | | | | | | | | | | |
|--------------------|-----------|-----------|-----------|-----------|-----------|-----------|-----------|-----------|-----------|-----------|-----------|-----------|-----------|-----------|-----------|-----------|
| BIT NUMBER | 31 | 30 | 29 | 28 | 27 | 26 | 25 | 24 | 23 | 22 | 21 | 20 | 19 | 18 | 17 | 16 |
| RESET STATE | 0 | 0 | 0 | 0 | 0 | 0 | 0 | 0 | 0 | 0 | 0 | 0 | 0 | 0 | 0 | 0 |

| | | | | | | | | | | | | | | | | |
|--------------------|-----------|-----------|-----------|-----------|-----------|-----------|----------|----------|----------|----------|----------|----------|----------|----------|----------|----------|
| BIT NUMBER | 15 | 14 | 13 | 12 | 11 | 10 | 9 | 8 | 7 | 6 | 5 | 4 | 3 | 2 | 1 | 0 |
| RESET STATE | 0 | 0 | 0 | 0 | 0 | 0 | 0 | 0 | 0 | 0 | 0 | 0 | 0 | 0 | 0 | 0 |

Table 9-4. Timestamp Offset Register Description

| BIT | FIELD NAME | TYPE | DESCRIPTION |
|-------|----------------------|------|---|
| 31 | DisableInitialOffset | RW | Bit 31 disables the use of the initial timestamp offset when the MPEG2 enhancements are enabled. A value of 0b indicates the use of the initial offset, a value of 1b indicates that the initial offset must not be applied to the calculated timestamp. This bit has no meaning for the DV timestamp enhancements. The default value for this bit is 0b. |
| 3-25 | RSVD | R | Reserved. Bits 30-25 return 000 0000b when read. |
| 24-12 | CycleCount | RW | This field adds an offset to the cycle count field in the timestamp when the DV or MPEG2 enhancements are enabled. The cycle count field is incremented modulo 8000; therefore, values in this field must be limited between 0 and 7999. The default value for this field is all 0s. |
| 11-0 | CycleOffset | RW | This field adds an offset to the cycle offset field in the timestamp when the DV or MPEG2 enhancements are enabled. The cycle offset field is incremented modulo 3072; therefore, values in this field must be limited between 0 and 3071. The default value for this field is all 0s. |

10 PHY Section

The cable interface can follow either the IEEE Std 1394a-2000 protocol or the IEEE Std 1394b-2002 protocol on both ports. The mode of operation is determined by the interface capabilities of the ports being connected. When either of the ports is connected to an IEEE Std 1394a-2000-compliant device, the cable interface on that port operates in the IEEE Std 1394a-2000 data-strobe mode at a compatible S100, S200, or S400 speed. When a bilingual port is connected to an IEEE Std 1394b-2002-compliant node, the cable interface on that port operates per the IEEE Std 1394b-2002 standard at S400B or S800 speed. The XIO2213A automatically determines the correct cable interface connection method for the bilingual ports.

To operate a port as an IEEE Std 1394b-2002 bilingual port, the data-strobe-only terminal for the port (DS0, DS1, or DS2_P) must be pulled to ground through a 1-k Ω resistor. The port must be operated in the IEEE Std 1394b-2002 bilingual mode whenever an IEEE Std 1394b-2002 bilingual or an IEEE Std 1394b-2002 Beta-only connector is connected to the port. To operate the port as an IEEE Std 1394a-2000-only port, the data-strobe-only terminal (DS0, DS1, or DS2_P) must be pulled to 3.3-V VCC through a 1-k Ω resistor. The only time the port must be forced to the data-strobe-only mode is if the port is connected to an IEEE Std 1394a-2000 connector (either 6 pin, which is recommended, or 4 pin). This mode is provided to ensure that IEEE Std 1394b-2002 signaling is never sent across an IEEE Std 1394a-2000 cable.

During packet reception, the serial data bits are split into 2-, 4-, or 8-bit parallel streams by the PHY section and sent to the link-layer controller (LLC) section. The received data is also transmitted (repeated) on the other connected and active cable ports.

Both the twisted pair A (TPA) and the twisted pair B (TPB) cable interfaces incorporate differential comparators to monitor the line states during initialization and arbitration when connected to an IEEE Std 1394a-2000-compliant device. The outputs of these comparators are used by the internal logic to determine the arbitration status. The TPA channel monitors the incoming cable common-mode voltage. The value of this common-mode voltage is used during IEEE Std 1394a-2000-mode arbitration and sets the speed of the next packet transmission. In addition, the TPB channel monitors the incoming cable common-mode voltage on the TPB pair for the presence of the remotely supplied twisted pair bias (TPBIAS) voltage.

When connected to an IEEE Std 1394a-2000-compliant node, the XIO2213A PHY section provides a 1.86-V nominal bias voltage at the TPBIAS terminal for port termination. The PHY section contains two independent TPBIAS circuits (one for each port). This bias voltage, when seen through a cable by a remote receiver, indicates the presence of an active connection. This bias voltage source must be stabilized by an external filter capacitor of 1 μ F.

The line drivers in the XIO2213A PHY section are designed to work with external 112- Ω termination resistor networks in order to match the 110- Ω cable impedance. One termination network is required at each end of a twisted-pair cable. Each network is composed of a pair of series-connected 56- Ω resistors. The midpoint of the pair of resistors that is connected to the TPA terminals is connected to its corresponding TPBIAS voltage terminal. The midpoint of the pair of resistors that is directly connected to the TPB terminals is coupled to ground through a parallel RC network, with recommended values of 5 k Ω and 270 pF. The values of the external line-termination resistors are selected to meet the standard specifications when connected in parallel with the internal receiver circuits. A precision external resistor connected between the R0 and R1 terminals sets the driver output current, along with other internal operating currents.

When the power supply of the XIO2213A is off while the twisted-pair cables are connected, the XIO2213A transmitter and receiver circuitry present to the cable a high-impedance signal that does not load the device at the other end of the cable.

When the XIO2213A PHY section is used without one or more of the ports brought out to a connector, the twisted-pair terminals of the unused ports must be terminated for reliable operation. For each unused port, the port must be forced to the IEEE Std 1394a-2000-only mode (data-strobe-only mode), after which the TPB+ and TPB– terminals can be tied together and then pulled to ground; or the TPB+ and TPB– terminals can be connected to the suggested normal termination network. The TPA+ and TPA– terminals of an unused port can be left unconnected. The TPBIAS terminal can be connected through a 1- μ F capacitor to ground or left unconnected.

The TESTM, TESTW, SE, and SM terminals are used to set up various manufacturing test conditions. For normal operation, the TESTM and TESTW terminals must be connected to VDD through a 1-k Ω resistor. The SE and SM terminals must be tied to ground through a 1-k Ω resistor.

The LPS_P (link power status) terminal of the PHY section works with the LKON terminal to manage the power usage in the node. The LPS_L signal from the LLC section is used in conjunction with the LCtrl bit (see [Table 10-1](#) and [Table 10-2](#)) to indicate the active/power status of the LLC section. The LPS_P signal also resets, disables, and initializes the PHY section-LLC section interface (the state of the PHY section-LLC section interface is controlled solely by the LPS_P input, regardless of the state of the LCtrl bit). The LPS_P terminal of the PHY section must be connected to the LPS_L terminal of the LLC section during normal operation.

The LPS_P input is considered inactive if it remains low for more than the PHY_RESET# time (see the LPS terminal definition) and is considered active otherwise. When the PHY section detects that the LPS_P input is inactive, the PHY section-LLC section interface is placed into a low-power reset state in which the CTL and D outputs are held in the logic 0 state and the LREQ input is ignored; however, the PCLK output remains active. If the LPS input remains low for more than the LPS_DISABLE time (see the LPS terminal definition), the PHY section-LLC section interface is put into a low-power disabled state in which the PCLK_P output is also held inactive. The XIO2213A continues the necessary PHY repeater functions required for normal network operation, regardless of the state of the PHY section-LLC section interface. When the interface is in the reset or disabled state and the LPS input is again observed active, the PHY section initializes the interface and returns to normal operation. The PHY section-LLC section interface is also held in the disabled state during hardware reset. When the LPS_P terminal is returned to an active state after being sensed as having entered the LPS_DISABLE time, the XIO2213A issues a bus reset. This broadcasts the node self-ID packet, which contains the updated L bit state (the PHY section and LLC section now being accessible).

The PHY section uses the LKON terminal to notify the LLC section to power up and become active. When activated, the output LKON signal is a square wave. The PHY section activates the LKON output when the LLC section is inactive and a wake-up event occurs. The LLC section is considered inactive when either the LPS_P input is inactive, as previously described, or the LCtrl bit is cleared to 0. A wake-up event occurs when a link-on PHY packet addressed to this node is received, or conditionally when a PHY interrupt occurs. The PHY section deasserts the LKON output when the LLC section becomes active (both LPS_P sensed as active and the LCtrl bit set to 1). The PHY section also deasserts the LKON output when a bus reset occurs, unless a PHY interrupt condition exists, which would otherwise cause LKON to be active. If the XIO2213A is power cycled and the power class is 0 through 4, the PHY section asserts LKON for approximately 167 ms or until both the LPS_P is active and the LCtrl bit is 1.

10.1 PHY Section Register Configuration

There are 16 accessible PHY section registers in the XIO2213A. The configuration of the registers at addresses 0h–7h (the base registers) is fixed, while the configuration of the registers at addresses 8h–Fh (the paged registers) is dependent on which of eight pages, numbered 0h–7h, is currently selected. The selected page is set in base register 7h. Note that while this register set is compatible with IEEE Std 1394a-2000 register sets, some fields have been redefined and this register set contains additional fields.

[Table 10-1](#) shows the configuration of the base registers, and [Table 10-2](#) gives the corresponding field descriptions. The base register field definitions are unaffected by the selected page number.

A reserved register or register field (marked as Reserved or Rsvd in the following register configuration tables) is read as 0, but is subject to future usage. All registers in address pages 2–6 are reserved.

Table 10-1. Base Register Description

| ADDRESS | BIT POSITION | | | | | | | |
|---------|-----------------|------|--------------|-------|-------------------|-----------|------|-----|
| | 0 | 1 | 2 | 3 | 4 | 5 | 6 | 7 |
| 0000 | Physical ID | | | | | | R | CPS |
| 0001 | RHB | IBR | Gap_Count | | | | | |
| 0010 | Extended(111b) | | | | Num_Ports(00011b) | | | |
| 0011 | PHY_Speed(111b) | | | RSVD | Delay(0000b) | | | |
| 0100 | LCtrl | C | Jitter(000b) | | | Pwr_Class | | |
| 0101 | WDIE | ISBR | CTOI | CPSI | STOI | PEI | EAA | EMC |
| 0110 | Max_Legacy SPD | | | BLINK | Bridge | | RSVD | |
| 0111 | Page_Select | | | RSVD | Port_Select | | | |

Table 10-2. Base Register Field Description

| Field | Size | Type | Description |
|-------------|------|-------|--|
| Physical ID | 6 | Rd | This field contains the physical address ID of this node determined during self-ID. The physical-ID is invalid after a bus reset until the self-ID has completed as indicated by an unsolicited register 0 status transfer from the PHY to the LLC. |
| R | 1 | Rd | Root. This bit indicates that this node is the root node. The R bit is reset to 0 by bus reset, and is set to 1 during tree-ID if this node becomes root. |
| CPS | 1 | Rd | Cable-power-status. This bit indicates the state of the CPS input terminal. The CPS terminal is normally tied to serial bus cable power through a 400-kΩ resistor. A 0 in this bit indicates that the cable power voltage has dropped below its threshold for ensured reliable operation. |
| RHB | 1 | Rd/Wr | Root-holdoff bit. This bit instructs the PHY to attempt to become root after the next bus reset. The RHB bit is reset to 0 by a hardware reset, and is unaffected by a bus reset. If two nodes on a single bus have their root holdoff bit set, then the result is not defined. To prevent two nodes from having their root-holdoff bit set, this bit must only be written using a PHY configuration packet. |
| IBR | 1 | Rd/Wr | Initiate bus reset. This bit instructs the PHY to initiate a long (166 μs) bus reset at the next opportunity. Any receive or transmit operation in progress when this bit is set completes before the bus reset is initiated. The IBR bit is reset to 0 after a hardware reset or a bus reset. Care must be exercised when writing to this bit to not change the other bits in this register. It is recommended that whenever possible a bus reset be initiated using the ISBR bit and not the IBR bit. |
| Gap_Count | 6 | Rd/Wr | Arbitration gap count. This value sets the subaction (fair) gap, arb-reset gap, and arb-delay times. The gap count can be set either by a write to the register, or by reception or transmission of a PHY_CONFIG packet. The gap count is reset to 3Fh by hardware reset or after two consecutive bus resets without an intervening write to the gap count register (either by a write to the PHY register or by a PHY_CONFIG packet). It is strongly recommended that this field only be changed using PHY configuration packets. |
| Extended | 3 | Rd | Extended register definition. For the XIO2213A, this field is 111b, indicating that the extended register set is implemented. |
| Num_Ports | 4 | Rd | Number of ports. This field indicates the number of ports implemented in the PHY. For the XIO2213A this field is 3. |
| PHY_Speed | 3 | Rd | PHY speed capability. This field is no longer used. For the XIO2213A PHY this field is 111b. Speeds for 1394b PHYs must be checked on a port-by-port basis. |
| Delay | 4 | Rd | PHY repeater data delay. This field indicates the worst case repeater data delay of the PHY, expressed as 144+(delay × 20) ns. For the XIO2213A this field is 02h. This value is the repeater delay for the S400B case, which is slower than the S800B or 1394a cases. Since the IEEE 1394B--2002 Std Phy register set only has a single field for the delay parameter, the slowest value is used. If a network uses only S800B or 1394a connections, then a delay value of 00h may be used. The worst case Phy repeater delay is 197 ns for S400B and 127 ns for S800B cable speeds (trained, raw bit speed). |

Table 10-2. Base Register Field Description (continued)

| Field | Size | Type | Description |
|-----------|------|-------|---|
| LCtrl | 1 | Rd/Wr | Link-active status control. This bit controls the indicated active status of the LLC section reported in the self-ID packet. The logical AND of this bit and the LPS active status is replicated in the L field (bit 9) of the self-ID packet. The LLC bit in the node self-ID packet is set active only if both the LPS input is active and the LCtrl bit is set. The LCtrl bit provides a software controllable means to indicate the LLC self-ID active status in lieu of using the LPS input terminal. The LCtrl bit is set to 1 by hardware reset and is unaffected by bus reset. NOTE: The state of the PHY section-LLC section interface is controlled solely by the LPS input, regardless of the state of the LCtrl bit. If the PHY section-LLC section interface is operational as determined by the LPS input being active, received packets and status information continue to be presented on the interface, and any requests indicated on the LREQ input are processed, even if the LCtrl bit is cleared to 0. |
| C | 1 | Rd/Wr | Contender status. This bit indicates that this node is a contender for the bus or isochronous resource manager. This bit is replicated in the c field (bit 20) of the self-ID packet. This bit is set to 0 on hardware reset. After hardware reset, this bit can only be set via a software register write. This bit is unaffected by a bus reset. |
| Jitter | 3 | Rd | PHY section repeater jitter. This field indicates the worst-case difference between the fastest and slowest repeater data delay, expressed as $(\text{jitter}+1) \times 20$ ns. For the XIO2213A, this field is 0. |
| Pwr_Class | 3 | Rd/Wr | Node power class. This field indicates this node power consumption and source characteristics and is replicated in the pwr field (bits 21–23) of the self-ID packet. This field is reset to the state specified by the PC0–PC2 input terminals on a hardware reset, and is unaffected by a bus reset. |
| WDIE | 1 | Rd/Wr | Watchdog interrupt enable. This bit, if set to 1, enables the port event interrupt (PIE) bit to be set when resume operations begin on any port, or when any of the CTOI, CPSI, or STOI interrupt bits are set and the PHY section-LLC section interface is nonoperational. This bit is reset to 0 by hardware reset and is unaffected by bus reset. |
| ISBR | 1 | Rd/Wr | Initiate short arbitrated bus reset. This bit, if set to 1, instructs the XIO2213A to initiate a short (1.3-ms) arbitrated bus reset at the next opportunity. This bit is reset to 0 by a bus reset. It is recommended that short bus reset is the only reset type initiated by software. IEC 61883-6 requires that a node initiate short bus resets to minimize any disturbance to an audio stream. NOTE: Legacy IEEE Std 1394-1995-compliant PHYs are not capable of performing short bus resets. Therefore, initiation of a short bus reset in a network that contains such a legacy device results in a long bus reset being performed. |
| CTOI | 1 | Rd/Wr | Configuration time-out interrupt. This bit is set to 1 when the arbitration controller times out during tree-ID start, and might indicate that the bus is configured in a loop. This bit is reset to 0 by hardware reset, or by writing a 1 to this register bit. If the CTOI and WDIE bits are both set and the LLC is or becomes inactive, the PHY section activates the LKON output to notify the LLC section to service the interrupt. NOTE: If the network is configured in a loop, then only those nodes that are part of the loop generate a configuration-time-out interrupt. Instead, all other nodes time out waiting for the tree-ID and/or self-ID process to complete and then generate a state time-out interrupt and bus reset. This bit is only set when the bus topology includes IEEE Std 1394a-2000 nodes; otherwise, IEEE Std 1394b-2002 loop healing prevents loops from being formed in the topology. |
| CPSI | 1 | Rd/Wr | Cable-power-status interrupt. This bit is set to 1 whenever the CPS input transitions from high to low, indicating that cable power might be too low for reliable operation. This bit is reset to 1 by hardware reset. It can be cleared by writing a 1 to this register bit. If the CPSI and WDIE bits are both set and the LLC section is or becomes inactive, the PHY section activates the LKON output to notify the LLC section to service the interrupt. |
| STOI | 1 | Rd/Wr | State-time-out interrupt. This bit indicates that a state time-out has occurred (which also causes a bus-reset to occur). This bit is reset to 0 by hardware reset, or by writing a 1 to this register bit. If the STOI and WDIE bits are both set and the LLC is or becomes inactive, the PHY section activates the LKON output to notify the LLC section to service the interrupt. |
| PEI | 1 | Rd/Wr | Port event interrupt. This bit is set to 1 on any change in the connected, bias, disabled, or fault bits for any port for which the port interrupt enable (PIE) bit is set. Additionally, if the resuming port interrupt enable (WDIE) bit is set, the PEI bit is set to 1 at the start of resume operations on any port. This bit is reset to 0 by hardware reset, or by writing a 1 to this register bit. |
| EAA | 1 | Rd/Wr | Enable accelerated arbitration. This bit enables the XIO2213A to perform the various arbitration acceleration enhancements defined in IEEE Std 1394a-2000 (ACK-accelerated arbitration, asynchronous fly-by concatenation, and isochronous fly-by concatenation). This bit is reset to 0 by hardware reset and is unaffected by bus reset. This bit has no effect when the device is operating in IEEE Std 1394b-2002 mode. |
| EMC | 1 | Rd/Wr | Enable multispeed concatenated packets. This bit enables the XIO2213A to transmit concatenated packets of differing speeds in accordance with the protocols defined in IEEE Std 1394a-2000. This bit is reset to 0 by hardware reset and is unaffected by bus reset. This bit has no effect when the device is operating in IEEE Std 1394b-2002 mode. |

Table 10-2. Base Register Field Description (continued)

| Field | Size | Type | Description |
|----------------|------|-------|---|
| Max Legacy SPD | 3 | Rd | Maximum legacy path speed. This field holds the maximum speed capability of any legacy node (IEEE Std 1394a-2000 or 1394-1995-compliant) as indicated in the self-ID packets received during bus initialization. Encoding is the same as for the PHY_SPEED field (but limited to S400 maximum). |
| BLINK | 1 | Rd | Beta-mode link. This bit indicates that a Beta-mode-capable LLC section is attached to the PHY section. This bit is set by the BMODE input terminal on the XIO2213A and should be set to 1. |
| Bridge | 2 | Rd/Wr | Bridge. This field controls the value of the bridge (brdg) field in the self-ID packet. The power reset value is 0. Details for when to set these bits are specified in the IEEE 1394.1 bridging specification. |
| Page_Select | 3 | Rd/Wr | Page Select. This field selects the register page to use when accessing register addresses 8–15. This field is reset to 0 by a hardware reset and is unaffected by bus reset. |
| Port_Select | 4 | Rd/Wr | Port Select. This field selects the port when accessing per-port status or control (for example, when one of the port status/control registers is accessed in page 0). Ports are numbered starting at 0. This field is reset to 0 by hardware reset and is unaffected by bus reset. |

The port-status page provides access to configuration and status information for each of the ports. The port is selected by writing 0 to the Page_Select field and the desired port number to the Port_Select field in base register 7. [Table 10-3](#) shows the configuration of the port-status page registers, and [Table 10-4](#) gives the corresponding field descriptions. If the selected port is not implemented, all registers in the port-status page are read as 0.

Table 10-3. Page-0 (Port Status) Register Description

| ADDRESS | BIT POSITION | | | | | | | |
|---------|-----------------------|-----------------------|-------|-----------|--------------|---------------|--------------|--------|
| | 0 | 1 | 2 | 3 | 4 | 5 | 6 | 7 |
| 1000 | Astat | | Bstat | | Ch | Con | RxOK | Dis |
| 1001 | Negotiated_speed | | | PIE | Fault | Standby_fault | Disscrn | B_Only |
| 1010 | DC_connected | Max_port_speed (011b) | | | LPP | Cable_speed | | |
| 1011 | Connection_unreliable | Reserved | | Beta_mode | | Reserved | | |
| 1100 | Port_error | | | | | | | |
| 1101 | Reserved | | | | Loop_disable | In_standby | Hard_disable | |
| 1110 | Reserved | | | | | | | |
| 1111 | Reserved | | | | | | | |

Table 10-4. Page-0 (Port Status) Register Field Description

| FIELD | SIZE | TYPE | DESCRIPTION | | | | | | | | | | |
|-------|-------------------|------|---|------|-------------------|----|---|----|---|----|---|----|---------|
| Astat | 2 | Rd | TPA line state. This field indicates the instantaneous TPA line state of the selected port, encoded as: <table border="1" style="margin-left: 20px;"> <thead> <tr> <th>Code</th> <th>Arbitration Value</th> </tr> </thead> <tbody> <tr> <td>11</td> <td>Z</td> </tr> <tr> <td>10</td> <td>1</td> </tr> <tr> <td>01</td> <td>0</td> </tr> <tr> <td>00</td> <td>invalid</td> </tr> </tbody> </table> | Code | Arbitration Value | 11 | Z | 10 | 1 | 01 | 0 | 00 | invalid |
| Code | Arbitration Value | | | | | | | | | | | | |
| 11 | Z | | | | | | | | | | | | |
| 10 | 1 | | | | | | | | | | | | |
| 01 | 0 | | | | | | | | | | | | |
| 00 | invalid | | | | | | | | | | | | |
| Bstat | 2 | Rd | TPB line state. This field indicates the TPB line state of the selected port. This field has the same encoding as the AStat field. | | | | | | | | | | |
| Ch | 1 | Rd | Child/parent status. A 1 indicates that the selected port is a child port. A 0 indicates that the selected port is the parent port. A disconnected, disabled, or suspended port is reported as a child port. The Ch bit is invalid after a bus reset until tree-ID has completed. | | | | | | | | | | |
| Con | 1 | Rd | Debounced port connection status. This bit indicates that the selected port is connected. The connection must be stable for the debounce time of approximately 341 ms for the Con bit to be set to 1. The Con bit is reset to 0 by hardware reset and is unaffected by bus reset. NOTE: The Con bit indicates that the port is physically connected to a peer PHY, but this does not necessarily mean that the port is active. For IEEE Std 1394b-2002-coupled connections, the Con bit is set when a port detects connection tones from the peer PHY and operating-speed negotiation is completed. | | | | | | | | | | |

Table 10-4. Page-0 (Port Status) Register Field Description (continued)

| FIELD | SIZE | TYPE | DESCRIPTION |
|-----------------------|------|-------|---|
| RxOK | 1 | Rd | Receive OK. In IEEE Std 1394a-2000 mode, this bit indicates the reception of a debounced TPBias signal. In Beta_mode, this bit indicates the reception of a continuous electrically valid signal. NOTE: RxOK is set to false during the time that only connection tones are detected in Beta mode. |
| Dis | 1 | RdWr | Port disabled control. If this bit is 1, the selected port is disabled. The Dis bit is reset to 0 by hardware reset (all ports are enabled for normal operation following hardware reset). The Dis bit is not affected by bus reset. When this bit is set, the port cannot become active; however, the port still tones, but does not establish an active connection. |
| Negotiated_speed | 1 | Rd | Negotiated speed. Indicates the maximum speed negotiated between this port and its immediately connected port. The encoding is as for Max_port_speed. It is set on connection when in Beta_mode, or to a value established during self-ID when in IEEE Std 1394a-2000 mode. |
| PIE | 1 | RdWr | Port event interrupt enable. When this bit is 1, a port event on the selected port sets the port event interrupt (PEI) bit and notifies the link. This bit is reset to 0 by a hardware reset and is unaffected by bus reset. |
| Fault | 1 | Rd/Wr | Fault. This bit indicates that a resume-fault or suspend-fault has occurred on the selected port, and that the port is in the suspended state. A resume-fault occurs when a resuming port fails to detect incoming cable bias from its attached peer. A suspend-fault occurs when a suspending port continues to detect incoming cable bias from its attached peer. Writing 1 to this bit clears the Fault bit to 0. This bit is reset to 0 by hardware reset and is unaffected by bus reset. |
| Standby_fault | 1 | Rd/Wr | Standby fault. This bit is set to 1 if an error is detected during a standby operation and cleared on exit from the standby state. A write of 1 to this bit or receipt of the appropriate remote command packet clears it to 0. When this bit is cleared, standby errors are cleared. |
| Disscrn | 1 | Rd/Wr | Disable scrambler. If this bit is set to 1, the data sent during packet transmission is not scrambled. |
| B_Only | 1 | Rd | Beta-mode operation only. For the XIO2213A, this bit is set to 0 for all ports. |
| DC_connected | 1 | Rd | If this bit is set to 1, the port has detected a dc connection to the peer port by means of an IEEE Std 1394a-2000-style connect-detect circuit. |
| Max_port_speed | 3 | Rd/Wr | Maximum port speed. The maximum speed at which a port is allowed to operate in Beta mode. The encoding is: 000 = S100 001 = S200 010 = S400 011 = S800 100 = S1600 101 = S3200 110 = Reserved 111 = Reserved An attempt to write to the register with a value greater than the hardware capability of the port results in the value for the maximum speed of which the port is capable being stored in the register. The port uses this register only when a new connection is established in the Beta mode. The power reset value is the maximum speed capable of the port. Software can modify this value to force a port to train at a lower than maximum, but no lower than minimum speed. |
| L | 1 | Rd | Local plug present. This flag is set permanently to 1. |
| Cable_speed | 3 | Rd | Cable speed. This variable is set to the value for the maximum speed that the port is capable of. The encoding is the same as for Max_port_speed. |
| Connection_unreliable | 1 | Rd/Wr | Connection unreliable. If this bit is set to 1, a Beta-mode speed negotiation has failed or synchronization has failed. A write of 1 to this field resets the value to 0. |
| Beta_mode | 1 | Rd | Operating in Beta mode. If this bit is 1, the port is operating in Beta mode; it is equal to 0 otherwise (that is, when operating in IEEE Std 1394a-2000 mode, or when disconnected). If Con is 1, RxOK is 1, and Beta_mode is 0, the port is active and operating in the IEEE Std 1394a-2000 mode. |
| Port_error | 8 | Rd/Wr | Port error. Incremented whenever the port receives an invalid codeword, unless the value is already 255. Cleared when read (including being read by means of a remote access packet). Intended for use by a single bus-wide diagnostic program. |
| Loop_disable | 1 | Rd | Loop disable. This bit is set to 1 if the port has been placed in the loop-disable state as part of the loop-free build process (the PHYs at either end of the connection are active, but if the connection itself were activated, a loop would exist). Cleared on bus reset and on disconnection. |
| In_standby | 1 | Rd | In standby. This bit is set to 1 if the port is in standby power-management state. |

Table 10-4. Page-0 (Port Status) Register Field Description (continued)

| FIELD | SIZE | TYPE | DESCRIPTION |
|--------------|------|-------|---|
| Hard_disable | 1 | Rd/Wr | Hard disable. No effect unless the port is disabled. If this bit is set to 1, the port does not maintain connectivity status on an ac connection when disabled. The values of the Con and RxOK bits are forced to 0. This flag can be used to force renegotiation of the speed of a connection. It can also be used to place the device into a lower-power state because when hard disabled, a port no longer tones to maintain IEEE Std 1394b-2002 ac-connectivity status. |

The vendor identification page identifies the vendor/manufacturer and compliance level. The page is selected by writing 1 to the Page_Select field in base register 7. [Table 10-5](#) shows the configuration of the vendor identification page, and [Table 10-6](#) shows the corresponding field descriptions.

Table 10-5. Page 1 (Vendor ID) Register Configuration

| ADDRESS | BIT POSITION | | | | | | | |
|---------|---------------|---|---|---|---|---|---|---|
| | 0 | 1 | 2 | 3 | 4 | 5 | 6 | 7 |
| 1000 | Compliance | | | | | | | |
| 1001 | Reserved | | | | | | | |
| 1010 | Vendor_ID[0] | | | | | | | |
| 1011 | Vendor_ID[1] | | | | | | | |
| 1100 | Vendor_ID[2] | | | | | | | |
| 1101 | Product_ID[0] | | | | | | | |
| 1110 | Product_ID[1] | | | | | | | |
| 1111 | Product_ID[2] | | | | | | | |

Table 10-6. Page 1 (Vendor ID) Register Field Descriptions

| FIELD | SIZE | TYPE | Description |
|------------|------|------|--|
| Compliance | 8 | Rd | Compliance level. For the XIO2213A, this field is 02h, indicating compliance with the IEEE Std 1394b-2002 specification. |
| Vendor_ID | 24 | Rd | Manufacturer's organizationally unique identifier (OUI). For the XIO2213A, this field is 08 0028h (TI) (the MSB is at register address 1010b). |
| Product_ID | 24 | Rd | Product identifier. For the XIO2213A, this field is 83_13_07h. |

The vendor-dependent page provides access to the special control features of the XIO2213A, as well as configuration and status information used in manufacturing test and debug. This page is selected by writing 7 to the Page_Select field in base register 7. [Table 10-7](#) shows the configuration of the vendor-dependent page, and [Table 10-8](#) shows the corresponding field descriptions.

Table 10-7. Page 7 (Vendor Dependant) Register Configuration

| ADDRESS | BIT POSITION | | | | | | | |
|---------|-------------------|-------------------|---|---|---|---|---|---|
| | 0 | 1 | 2 | 3 | 4 | 5 | 6 | 7 |
| 1000 | Reserved | | | | | | | |
| 1001 | Reserved for test | | | | | | | |
| 1010 | Reserved for test | | | | | | | |
| 1011 | Reserved for test | | | | | | | |
| 1100 | Reserved for test | | | | | | | |
| 1101 | Reserved for test | | | | | | | |
| 1110 | SWR | Reserved for test | | | | | | |
| 1111 | Reserved for test | | | | | | | |

Table 10-8. Page 7 (Vendor Dependant) Register Field Descriptions

| FIELD | SIZE | TYPE | Description |
|-------|------|-------|--|
| SWR | 1 | Rd/Wr | Software hard reset. Writing a 1 to this bit forces a hard reset of the PHY section (same effect as momentarily asserting the RESET terminal low). This bit is always read as a 0. |

10.2 PHY Section Application Information

10.2.1 Power Class Programming

The PC0–PC2 terminals are programmed to set the default value of the power class indicated in the pwr field (bits 21–23) of the transmitted self-ID packet. Descriptions of the various power classes are given in [Table 10-9](#). The default power-class value is loaded following a hardware reset, but is overridden by any value subsequently loaded into the Pwr_Class field in register 4.

Table 10-9. Register Description

| PC[0:2] | DESCRIPTION |
|---------|--|
| 000 | Node does not need power and does not repeat power. |
| 001 | Node is self powered and provides a minimum of 15 W to the bus. |
| 010 | Node is self powered and provides a minimum of 30 W to the bus. |
| 011 | Node is self powered and provides a minimum of 5 W to the bus. |
| 100 | Node may be powered from the bus and is using up to 3 W; no additional power is needed to enable the link. The node may also provide power to the bus. The amount of bus power that it provides can be found in the configuration ROM. |
| 101 | Reserved for future standardization. |
| 110 | Node is powered from the bus and uses up to 3 W. An additional 3 W is needed to enable the link. |
| 111 | Node is powered from the bus and uses up to 3 W. An additional 7 W is needed to enable the link. |

10.2.2 Power-Up Reset

To ensure proper operation of the XIO2213A PHY section, the $\overline{\text{RESET}}$ terminal must be asserted low for a minimum of 2 ms from the time that DVDD, AVDD, and PLLVDD power reaches the minimum required supply voltage and the input clock is valid. If a fundamental-mode crystal is used rather than an oscillator, the start-up time parameter may be set to zero. When using a passive capacitor on the $\overline{\text{RESET}}$ terminal to generate a power-on-reset signal, the minimum reset time is assured if the value of the capacitor satisfies the following equation (the value must be no smaller than approximately 0.1 μF):

$$C_{\min} = (0.0077 \times T) + 0.085 + (\text{external_oscillator_start-up_time} \times 0.05)$$

Where:

C_{\min} = Minimum capacitance on the $\overline{\text{RESET}}$ terminal in μF

T = V_{DD} ramp time, 10%–90% (in ms)

external_oscillator_start-up_time = Time from power applied to the external oscillator until the oscillator outputs a valid clock in ms

10.2.3 Crystal Oscillator Selection

The XIO2213A is designed to use an external 98.304-MHz crystal oscillator connected to the XI terminal to provide the reference clock. This clock, in turn, drives a PLL circuit that generates the various clocks required for transmission and resynchronization of data at the S100 through S800 media data rates.

A variation of less than ± 100 ppm from nominal for the media data rates is required by IEEE Std 1394. Adjacent PHYs may, therefore, have a difference of up to 200 ppm from each other in their internal clocks, and PHYs must be able to compensate for this difference over the maximum packet length. Larger clock variations can cause resynchronization overflows or underflows, resulting in corrupted packet data.

For the XIO2213A, the PCLK output can be used to measure the frequency accuracy and stability of the internal oscillator and PLL from which it is derived. The frequency of the PCLK output must be within ± 100 ppm of the nominal frequency of 98.304 MHz.

The following are some typical specifications for an oscillator used with the XIO2213A, in order to achieve the required frequency accuracy and stability:

- RMS jitter of 5 ps or less
- RMS phase-noise jitter of 1 ps or less over the range 12 kHz to 20 MHz or higher
- Frequency tolerance at 25°C: Total frequency variation for the complete circuit is ± 100 ppm. A device with ± 30 -ppm or ± 50 -ppm frequency tolerance is recommended for adequate margin.
- Frequency stability (over temperature and age): A device with ± 30 -ppm or ± 50 -ppm frequency stability is recommended for adequate margin.

The total frequency variation must be kept below ± 100 ppm from nominal, with some allowance for error introduced by board and device variations. Trade-offs between frequency tolerance and stability may be made, as long as the total frequency variation is less than ± 100 ppm. For example, the frequency tolerance of the crystal may be specified at 50 ppm and the temperature tolerance may be specified at 30 ppm to give a total of 80-ppm possible variation due to the oscillator alone. Aging also contributes to the frequency variation. It is strongly recommended that part of the verification process for the design is to measure the frequency of the PCLK output of the PHY section. This should be done using a frequency counter with an accuracy of 6 digits or better.

10.2.4 Bus Reset

It is recommended that whenever the user has a choice, the user should initiate a bus reset by writing to the initiate-short-bus-reset (ISBR) bit (bit 1 PHY register 0101b). Care must be taken not to change the value of any of the other writeable bits in this register when the ISBR bit is written to.

In the XIO2213A, the initiate-bus-reset (IBR) bit can be set to 1 in order to initiate a bus reset and initialization sequence; however, it is recommended to use the ISBR bit instead. The IBR bit is located in PHY register 1 along with the root-holdoff bit (RHB) and gap count. As required by the IEEE Std 1394b-2002 Supplement, this configuration maintains compatibility with older TI PHY designs that were based on either the suggested register set defined in Annex J of IEEE Std 1394-1995 or the IEEE Std 1394a-2000 Supplement. Therefore, whenever the IBR bit is written, the RHB and gap count are also necessarily written.

It is recommended that the RHB and gap count only be updated by PHY configuration packets. The XIO2213A is IEEE Std 1394a-2000 and IEEE Std 1394b-2002 compliant and, therefore, both the reception and transmission of PHY configuration packets cause the RHB and gap count to be loaded, unlike older IEEE Std 1394-1995-compliant PHYs that decode only received PHY configuration packets.

The gap count is set to the maximum value of 63 after two consecutive bus resets without an intervening write to the gap count, either by a write to PHY register 1 or by a PHY configuration packet. This mechanism allows a PHY configuration packet to be transmitted and then a bus reset initiated to verify that all nodes on the bus have updated their RHBs and gap counts, without having the gap count set back to 63 by the bus reset. The subsequent connection of a new node to the bus, which initiates a bus reset, then causes the gap count of each node to be set to 63. Note, however, that if a subsequent bus reset is instead initiated by a write to register 1 to set the IBR bit, all other nodes on the bus have their gap counts set to 63, while this node's gap count remains set to the value just loaded by the write to PHY register 1.

Therefore, in order to maintain consistent gap counts throughout the bus, the following rules apply to the use of the IBR bit, RHB, and gap count in PHY register 1:

- Following the transmission of a PHY configuration packet, a bus reset must be initiated in order to verify that all nodes have correctly updated their RHBs and gap counts, and to ensure that a subsequent new connection to the bus causes the gap count to be set to 63 on all nodes in the bus. If this bus reset is initiated by setting the IBR bit to 1, the RHB and gap count register must also be loaded with the correct values consistent with the just-transmitted PHY configuration packet. In the

XIO2213A, the RHB and gap count have been updated to their correct values on the transmission of the PHY configuration packet, so these values can first be read from register 1 and then rewritten.

- Other than to initiate the bus reset that must follow the transmission of a PHY configuration packet, whenever the IBR bit is set to 1 in order to initiate a bus reset, the gap count must also be set to 63 to be consistent with other nodes on the bus, and the RHB must be maintained with its current value.
- The PHY register 1 must not be written to except to set the IBR bit. The RHB and gap count must not be written without also setting the IBR bit to 1.
- To avoid these problems all bus resets initiated by software must be initiated by writing the ISBR bit (bit 1 PHY register 0101b). Care must be taken to not change the value of any of the other writeable bits in this register when the ISBR bit is written to. Also, the only means to change the gap count of any node must be by means of the PHY configuration packet, which changes all nodes to the same gap count.

11 Electrical Characteristics

11.1 Absolute Maximum Ratings

over operating temperature range (unless otherwise noted) ⁽¹⁾

| | | VALUE | UNIT | |
|--|---|-----------------------------------|-----------------------------|---|
| V_{SUP_33} | Supply voltage range ($DVDD_33, V_{DDA_33}, V_{DDA_33}, V_{DDPLL_33}, V_{DD_33_COMB}, V_{DD_33_COMBIO}$) | -0.3 to 3.6 | V | |
| V_{SUP_15} | Supply voltage range ($V_{DD_15}, V_{DDA_15}, V_{PP}, V_{DDPLL}, V_{DD_15_COMB}$) | -0.5 to 1.65 | V | |
| V_I | Input voltage range | PCI Express (RX) | -0.5 to $V_{SUP_33} + 0.5$ | V |
| | | PCI Express REFCLK (single-ended) | -0.5 to $V_{SUP_15} + 0.5$ | V |
| | | PCI Express REFCLK (differential) | -0.5 to $V_{SUP_33} + 0.5$ | V |
| | | Miscellaneous 3.3-V IO | -0.5 to $V_{SUP_33} + 0.5$ | V |
| | | PHY Interface | -0.5 to $V_{SUP_33} + 0.5$ | V |
| V_O | Output voltage range | PCI Express (TX) | -0.5 to $V_{SUP_15} + 0.5$ | V |
| | | Miscellaneous 3.3-V IO | -0.5 to $V_{SUP_33} + 0.5$ | V |
| | | PHY Interface | -0.5 to $V_{SUP_33} + 0.5$ | V |
| Input clamp current, ($V_I < 0$ or $V_I > V_{DD}$) ⁽²⁾ | | ± 20 | mA | |
| Output clamp current, ($V_O < 0$ or $V_O > V_{DD}$) ⁽³⁾ | | ± 20 | mA | |
| Human body model (HBM) ESD performance | | 1500 | V | |
| Charged device model (CDM) ESD performance | | 500 | V | |
| T_{stg} | Storage temperature range | -65 to 150 | °C | |

- (1) Stresses beyond those listed under absolute maximum ratings may cause permanent damage to the device. These are stress ratings only, and functional operation of the device at these or any other conditions beyond those indicated under recommended operating conditions is not implied. Exposure to absolute-maximum-rated conditions for extended periods may affect device reliability.
- (2) Applies for external input and bidirectional buffers. $V_I < 0$ or $V_I > V_{DD}$ or $V_I > V_{CCP}$.
- (3) Applies for external input and bidirectional buffers. $V_O < 0$ or $V_O > V_{DD}$ or $V_O > V_{CCP}$.

11.2 Recommended Operating Conditions

| | | OPERATION | MIN | NOM | MAX | UNIT |
|---------------|---|-----------|------|-----|------|------|
| V_{SUP_15} | Supply voltage | 1.5 V | 1.35 | 1.5 | 1.65 | V |
| V_{SUP_33} | Supply voltage (I/O) | 3.3 V | 3 | 3.3 | 3.6 | V |
| T_A | Operating ambient temperature range | | 0 | 25 | 70 | °C |
| T_J | Virtual junction temperature ⁽¹⁾ | | 0 | 25 | 115 | °C |

- (1) The junction temperature reflects simulated conditions. The customer is responsible for verifying junction temperature.

11.3 PCI Express Differential Transmitter Output Ranges

| PARAMETER | TERMINALS | MIN | NOM | MAX | UNIT | COMMENTS |
|--|-----------|--------|------|--------|------|---|
| UI Unit interval | TXP, TXN | 399.88 | 400 | 400.12 | ps | Each UI is 400 ps \pm 300 ppm. UI does not account for SSC dictated variations. See ⁽¹⁾ |
| $V_{TX-DIFFP-P}$ Differential peak-to-peak output voltage | TXP, TXN | 0.8 | | 1.2 | V | $V_{TX-DIFFP-P} = 2 * V_{TXP} - V_{TXN} $ See Note ⁽²⁾ . |
| $V_{TX-DE-RATIO}$ De-emphasized differential output voltage (ratio) | TXP, TXN | -3.0 | -3.5 | -4.0 | dB | This is the ratio of the $V_{TX-DIFFP-P}$ of the second and following bits after a transition divided by the $V_{TX-DIFFP-P}$ of the first bit after a transition. See ⁽²⁾ |

- (1) No test load is necessarily associated with this value.
- (2) Specified at the measurement point into a timing and voltage compliance test load and measured over any 250 consecutive TX UIs.

PCI Express Differential Transmitter Output Ranges (continued)

| PARAMETER | TERMINALS | MIN | NOM | MAX | UNIT | COMMENTS |
|---|-----------|-------|-----|------|----------|---|
| TTX-EYE Minimum TX eye width | TXP, TXN | 0.75 | | | UI | The maximum transmitter jitter can be derived as $T_{TXMAX-JITTER} = 1 - T_{TX-EYE} = 0.3$ UI See ⁽²⁾ ⁽³⁾ |
| $T_{TX-EYE-MEDIAN-to-MAX-JITTER}$ Maximum time between the jitter median and maximum deviation from the median | TXP, TXN | | | 0.15 | UI | Jitter is defined as the measurement variation of the crossing points ($V_{TX-DIFFP-P} = 0$ V) in relation to recovered TX UI. A recovered TX UI is calculated over 3500 consecutive UIs of sample data. Jitter is measured using all edges of the 250 consecutive UIs in the center of the 3500 UIs used for calculating the TX UI. See ⁽²⁾ and ⁽³⁾ |
| $T_{TX-RISE}$, $T_{TX-FALL}$ P/N TX output rise/fall time | TXP, TXN | 0.125 | | | UI | See ⁽²⁾ and ⁽⁴⁾ . |
| $V_{TX-CM-ACp}$ RMS ac peak common mode output voltage | TXP, TXN | | | 20 | mV | $V_{TX-CM-ACp} = \text{RMS}(V_{TXP} + V_{TXN} /2 - V_{TX-CM-DC})$ $V_{TX-CM-DC} = \text{DC(avg)}$ of $ V_{TXP} + V_{TXN} /2$ See ⁽²⁾ . |
| $V_{TX-CM-DC-ACTIVE-IDLE-DELTA}$ Absolute delta of dc common mode voltage during L0 and electrical idle. | TXP, TXN | 0 | | 100 | mV | $ V_{TX-CM-DC} - V_{TX-CM-Idle-DC} \leq 100$ mV $V_{TX-CM-DC} = \text{DC(avg)}$ of $ V_{TXP} + V_{TXN} /2$ [during L0] $V_{TX-CM-Idle-DC} = \text{DC(avg)}$ of $ V_{TXP} + V_{TXN} /2$ [during electrical idle] See ⁽²⁾ . |
| $V_{TX-CM-DC-LINE-DELTA}$ Absolute delta of dc common mode voltage between P and N | TXP, TXN | 0 | | 25 | mV | $ V_{TXP-CM-DC} - V_{TXN-CM-DC} \leq 25$ mV when $V_{TXP-CM-DC} = \text{DC(avg)}$ of $ V_{TXP} $ $V_{TXN-CM-DC} = \text{DC(avg)}$ of $ V_{TXN} $ See ⁽²⁾ |
| $V_{TX-IDLE-DIFFp}$ Electrical idle differential peak output voltage | TXP, TXN | 0 | | 20 | mV | $V_{TX-IDLE-DIFFp} = V_{TXP-Idle} - V_{TXN-Idle} \leq 20$ mV See ⁽²⁾ . |
| $V_{TX-RCV-DETECT}$ The amount of voltage change allowed during receiver detection | TXP, TXN | | | 600 | mV | The total amount of voltage change that a transmitter can apply to sense whether a low impedance receiver is present. |
| $V_{TX-DC-CM}$ The TX dc common mode voltage | TXP, TXN | 0 | | 3.6 | V | The allowed dc common mode voltage under any condition. |
| $I_{TX-SHORT}$ TX short circuit current limit | TXP, TXN | | | 90 | mA | The total current the transmitter can provide when shorted to its ground. |
| $T_{TX-IDLE-MIN}$ Minimum time spent in electrical idle | TXP, TXN | 50 | | | UI | Minimum time a transmitter must be in electrical Idle. Utilized by the receiver to start looking for an electrical idle exit after successfully receiving an electrical idle ordered set. |
| $T_{TX-IDLE-SET-to-IDLE}$ Maximum time to transition to a valid electrical idle after sending an electrical idle ordered set | TXP, TXN | | | 20 | UI | After sending an electrical idle ordered set, the transmitter must meet all electrical idle specifications within this time. This is considered a debounce time for the transmitter to meet electrical idle after transitioning from L0. |
| $T_{TX-IDLE-to-DIFF-DATA}$ Maximum time to transition to valid TX specifications after leaving an electrical idle condition | TXP, TXN | | | 20 | UI | Maximum time to meet all TX specifications when transitioning from electrical idle to sending differential data. This is considered a debounce time for the TX to meet all TX specifications after leaving electrical idle. |
| $RL_{TX-DIFF}$ Differential return loss | TXP, TXN | 10 | | | dB | Measured over 50 MHz to 1.25 GHz. See ⁽⁵⁾ . |
| RL_{TX-CM} Common mode return loss | TXP, TXN | 6 | | | dB | Measured over 50 MHz to 1.25 GHz. See ⁽⁵⁾ |
| $Z_{TX-DIFF-DC}$ DC differential TX impedance | TXP, TXN | 80 | 100 | 120 | Ω | TX dc differential mode low impedance |
| Z_{TX-DC} Transmitter dc impedance | TXP, TXN | 40 | | | Ω | Required TXP as well as TXN dc impedance during all states |
| C_{TX} AC coupling capacitor | TXP, TXN | 75 | | 200 | nF | All transmitters are ac-coupled and are required on the PWB. |

- (3) A $T_{TX-EYE} = 0.75$ UI provides for a total sum of deterministic and random jitter budget of $T_{TX-JITTER-MAX} = 0.25$ UI for the transmitter collected over any 250 consecutive TX UIs. The $T_{TX-EYE-MEDIAN-to-MAX-JITTER}$ specification ensures a jitter distribution in which the median and the maximum deviation from the median is less than half of the total TX jitter budget collected over any 250 consecutive TX UIs. It must be noted that the median is not the same as the mean. The jitter median describes the point in time where the number of jitter points on either side is approximately equal as opposed to the averaged time value.
- (4) Measured between 20% and 80% at transmitter package terminals into a test load for both V_{TXP} and V_{TXN} .
- (5) The transmitter input impedance results in a differential return loss greater than or equal to 12 dB and a common mode return loss greater than or equal to 6 dB over a frequency range of 50 MHz to 1.25 GHz. This input impedance requirement applies to all valid input levels. The reference impedance for return loss measurements is 50 Ω to ground for both the P and N lines. Note that the series capacitors C_{TX} is optional for the return loss measurement.

11.4 PCI Express Differential Receiver Input Ranges

| PARAMETER | TERMINALS | MIN | NOM | MAX | UNIT | COMMENTS |
|---|-----------|--------|-----|--------|------|--|
| UI Unit interval | RXP, RXN | 399.88 | 400 | 400.12 | ps | Each UI is 400 ps ±300 ppm. UI does not account for SSC dictated variations. See ⁽¹⁾ . |
| $V_{RX-DIFF-P}$ Differential input peak-to-peak voltage | RXP, RXN | 0.175 | | 1.200 | V | $V_{RX-DIFF-P} = 2 * V_{RXP} - V_{RXN} $. See ⁽²⁾ . |
| T_{RX-EYE} Minimum receiver eye width | RXP, RXN | 0.4 | | | UI | The maximum interconnect media and transmitter jitter that can be tolerated by the receiver is derived as $T_{RX-MAX-JITTER} = 1 - T_{RX-EYE} = 0.6$ UI. See ⁽²⁾ and ⁽³⁾ . |
| $T_{RX-EYE-MEDIAN-to-MAX-JITTER}$ Maximum time between the jitter median and maximum deviation from the median | RXP, RXN | | | 0.3 | UI | Jitter is defined as the measurement variation of the crossing points ($V_{RX-DIFF-P} = 0$ V) in relation to recovered TX UI. A recovered TX UI is calculated over 3500 consecutive UIs of sample data. Jitter is measured using all edges of the 250 consecutive UIs in the center of the 3500 UIs used for calculating the TX UI. See ⁽²⁾ and ⁽³⁾ . |
| $V_{RX-CM-ACp}$ AC peak common mode input voltage | RXP, RXN | | | 150 | mV | $V_{RX-CM-ACp} = RMS(V_{RXP} + V_{RXN} /2 - V_{RX-CM-DC})$ $V_{RX-CM-DC} = DC_{(avg)}$ of $ V_{RXP} + V_{RXN} /2$. See ⁽²⁾ . |
| $RL_{RX-DIFF}$ Differential return losse | RXP, RXN | 10 | | | dB | Measured over 50 MHz to 1.25 GHz with the P and N lines biased at +300 mV and -300 mV, respectively. See ⁽⁴⁾ . |
| RL_{RX-CM} Common mode return loss | RXP, RXN | 6 | | | dB | Measured over 50 MHz to 1.25 GHz with the P and N lines biased at +300 mV and -300 mV, respectively. See ⁽⁴⁾ . |
| $Z_{RX-DIFF-DC}$ DC differential input impedance | RXP, RXN | 80 | 100 | 120 | Ω | RX dc differential mode impedance See ⁽⁴⁾ . |
| Z_{RX-DC} DC input impedance | RXP, RXN | 40 | 50 | 60 | Ω | Required RXP as well as RXN dc impedance (50Ω ±20% tolerance). See ⁽²⁾ and ⁽⁵⁾ . |
| $Z_{RX-HIGH-IMP-DC}$ Powered down dc input impedance | RXP, RXN | 200 | | | kΩ | Required RXP as well as RXN dc impedance when the receiver terminations do not have power. See ⁽⁶⁾ . |
| $V_{RX-IDLE-DET-DIFF-P}$ Electrical idle detect threshold | RXP, RXN | 65 | | 175 | mV | $V_{RX-IDLE-DET-DIFF-P} = 2 * V_{RXP} - V_{RXN} $ measured at the receiver package terminals |
| $T_{RX-IDLE-DET-DIFF-ENTER-TIME}$ Unexpected electrical idle enter detect threshold integration time | RXP, RXN | | | 10 | ms | An unexpected electrical idle ($V_{RX-DIFF-P} < V_{RX-IDLE-DET-DIFF-P}$) must be recognized no longer than $T_{RX-IDLE-DET-DIFF-ENTER-TIME}$ to signal an unexpected idle condition. |

- (1) No test load is necessarily associated with this value.
- (2) Specified at the measurement point and measured over any 250 consecutive UIs. A test load must be used as the RX device when taking measurements. If the clocks to the RX and TX are not derived from the same reference clock, then the TX UI recovered from 3500 consecutive UI is used as a reference for the eye diagram.
- (3) A $TRX-EYE = 0.40$ UI provides for a total sum of 0.60 UI deterministic and random jitter budget for the transmitter and interconnect collected any 250 consecutive UIs. The $TRX-EYE-MEDIAN-to-MAX-JITTER$ specification ensures a jitter distribution in which the median and the maximum deviation from the median is less than half of the total UI jitter budget collected over any 250 consecutive TX UIs. It must be noted that the median is not the same as the mean. The jitter median describes the point in time where the number of jitter points on either side is approximately equal as opposed to the averaged time value. If the clocks to the RX and TX are not derived from the same reference clock, then the TX UI recovered from 3500 consecutive UIs must be used as the reference for the eye diagram.
- (4) The receiver input impedance results in a differential return loss greater than or equal to 15 dB with the P line biased to 300 mV and the N line biased to -300 mV and a common mode return loss greater than or equal to 6 dB (no bias required) over a frequency range of 50 MHz to 1.25 GHz. This input impedance requirement applies to all valid input levels. The reference impedance for return loss measurements for is 50 Ω to ground for both the P and N line (i.e., as measured by a Vector Network Analyzer with 50-Ω probes). The series capacitors CTX is optional for the return loss measurement.
- (5) Impedance during all link training status state machine (LTSSM) states. When transitioning from a PCI Express reset to the detect state (the initial state of the LTSSM) there is a 5-ms transition time before receiver termination values must be met on the unconfigured lane of a port.
- (6) The RX dc common mode impedance that exists when no power is present or PCI Express reset is asserted. This helps ensure that the receiver detect circuit does not falsely assume a receiver is powered on when it is not. This term must be measured at 300 mV above the RX ground.

11.5 PCI Express Differential Reference Clock Input Ranges⁽¹⁾

| PARAMETER | TERMINALS | MIN | NOM | MAX | UNIT | COMMENTS |
|--|--------------------|------------------|-----|------------------|------------|---|
| $f_{IN-DIFF}$ Differential input frequency | REFCLK+ REFCLK– | | 100 | | MHz | The input frequency is 100 MHz + 300 ppm and –2800 ppm including SSC-dictated variations. |
| f_{IN-SE} Single-ended input frequency | REFCLK+ | | 125 | | MHz | The input frequency is 125 MHz + 300 ppm and –300 ppm. |
| $V_{RX-DIFF-P}$ Differential input peak-to-peak voltage | REFCLK+ REFCLK– | 0.175 | | 1.200 | V | $V_{RX-DIFF-P} = 2 * V_{REFCLK+} - V_{REFCLK-} R$ |
| V_{IH-SE} | REFCLK+ | $0.7 V_{DD_33}$ | | V_{DD_33} | V | Single-ended, reference clock mode high-level input voltage |
| V_{IL-SE} | REFCLK+ | 0 | | $0.3 V_{DD_33}$ | V | Single-ended, reference clock mode low-level input voltage |
| $V_{RX-CM-ACP}$ AC peak common mode input voltage | REFCLK+ REFCLK– | | | 140 | mV | $V_{RX-CM-ACP} = \text{RMS}(V_{REFCLK+} + V_{REFCLK-} /2 V_{RX-CM-DC})$ $V_{RX-CM-DC} = \text{DC}_{(avg)}$ of $ V_{REFCLK+} + V_{REFCLK-} /2$ |
| Duty cycle | REFCLK+ REFCLK– | 40% | | 60% | | Differential and single-ended waveform input duty cycle |
| $Z_{RX-DIFF-DC}$ DC differential input impedance | REFCLK+ REFCLK– | | 20 | | k Ω | REFCLK \pm dc differential mode impedance |
| Z_{RX-DC} DC input impedance | REFCLK+ REFCLK– | | 20 | | k Ω | REFCLK+ dc single-ended mode impedance |

- (1) The XIO2213A is compliant with the defined system jitter models for a PCI-Express reference clock and associated TX/RX link. These system jitter models are described in the *PCI-Express Jitter Modeling*, Revision 1.0RD document. Any usage of the XIO2213A in a system configuration that does not conform to the defined system jitter models requires the system designer to validate the system jitter budgets.

11.6 Electrical Characteristics Over Recommended Operating Conditions (3.3-V I/O)

NOTE: This table applies to $\overline{\text{PERST}}$, $\overline{\text{WAKE}}$, REFCLK_SEL, $\overline{\text{GRST}}$, GPIO7:0, CNA, PC2:0, and all RSVD terminals.

| PARAMETER | OPERATION | TEST CONDITIONS | MIN | MAX | UNIT |
|---|--------------|---------------------------|------------------|-------------------|---------------|
| V_{IH} High-level input voltage ⁽¹⁾ | V_{DD_33} | | $0.7 V_{DD_33}$ | V_{DD_33} | V |
| V_{IL} VIL Low-level input voltage ⁽¹⁾ | V_{DD_33} | | 0 | $0.3 V_{DD_33}$ | V |
| V_I Input voltage | | | 0 | V_{DD_33} | V |
| V_O Output voltage ⁽²⁾ | | | 0 | V_{DD_33} | V |
| t_T Input transition time (t_{rise} and t_{fall}) | | | 0 | 25 | ns |
| V_{hys} Input hysteresis ⁽³⁾ | | | | $0.3 V_{DD_33}$ | V |
| V_{OH} High-level output voltage | V_{DD_33} | $I_{OH} = -4 \text{ mA}$ | $0.8 V_{DD_33}$ | | V |
| V_{OL} Low-level output voltage | V_{DD_33} | $I_{OL} = 4 \text{ mA}$ | | $0.22 V_{DD_33}$ | V |
| I_{OZ} High-impedance, output current ⁽²⁾ | V_{DD_33} | $V_I = 0$ to V_{DD_33} | | ± 20 | μA |
| I_{OZP} High-impedance, output current with internal pullup or pulldown resistor ⁽⁴⁾ | V_{DD_33} | $V_I = 0$ to V_{DD_33} | | ± 100 | μA |
| I_I Input current ⁽⁵⁾ | V_{DD_33} | $V_I = 0$ to V_{DD_33} | | ± 1 | μA |

- (1) Applies to external inputs and bidirectional buffers.
 (2) Applies to external outputs and bidirectional buffers.
 (3) Applies to $\overline{\text{PERST}}$ and $\overline{\text{GRST}}$.
 (4) Applies to $\overline{\text{GRST}}$ (pullup resistor) and most GPIO (pullup resistor).
 (5) Applies to external input buffers.

11.7 Electrical Characteristics Over Recommended Operating Conditions (PHY Port Driver)

| PARAMETER | TEST CONDITIONS | MIN | TYP | MAX | UNIT |
|--------------------------------|---|---------------------------------------|----------------------|----------------------|------|
| V _{OD} | 1394a differential output voltage | 56 Ω, See Figure 11-1 | 172 | 265 | mV |
| | 1394b differential output voltage | | 700 | | |
| I _{DIFF} | Driver difference current. TPA+, TPA-, TPB+, TPB- | Drivers enabled, speed signaling off | -1.05 ⁽¹⁾ | 1.05 ⁽¹⁾ | mA |
| I _{SP20} ₀ | Common-mode speed signaling current. TPB+, TPB- | S200 speed signaling enabled | -4.84 ⁽²⁾ | -2.53 ⁽²⁾ | mA |
| I _{SP40} ₀ | Common-mode speed signaling current. TPB+, TPB- | S400 speed signaling enabled | -12.4 ⁽²⁾ | -8.1 ⁽²⁾ | mA |
| V _{OFF} | Off state differential voltage | Drivers disabled | | 20 | mV |
| V _{CM} | 1394b common-mode voltage | | 1.5 | | V |

- (1) Limits defined as algebraic sum of TPA+ and TPA- driver currents. Limits also apply to algebraic sum of TPB+ and TPB- driver currents.
 (2) Limits defined as absolute limit of each of TPB+ and TPB- driver currents.

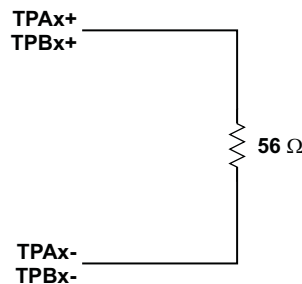

Figure 11-1. Test Load Diagram

11.8 Switching Characteristics for PHY Port Driver

| PARAMETER | TEST CONDITIONS | MIN | TYP | MAX | UNIT |
|------------------|---|-------------------------------|-----|-------|------|
| Jitter, transmit | Between TPA and TPB | | | ±0.15 | ns |
| Skew, transmit | Between TPA and TPB | | | ±0.1 | ns |
| t _r | TP differential rise time, transmit | 10% to 90%, at 1394 connector | 0.5 | 1.2 | ns |
| t _f | TP differential fall time, transmit | 90% to 10%, at 1394 connector | 0.5 | 1.2 | ns |
| t _{su} | Setup time, CTL0, CTL1, D1-D7, LREQ until PCLK - 1394a-2000 | 50% to 50% | 2.5 | | ns |
| t _h | Hold time, CTL0, CTL1, D1-D7, LREQ after PCLK - 1394a-2000 | 50% to 50% | 0 | | ns |
| t _{su} | Setup time, CTL0, CTL1, D1-D7, LREQ until PCLK - 1394b | 50% to 50% | 2.5 | | ns |
| t _h | Hold time, CTL0, CTL1, D1-D7, LREQ after PCLK - 1394b | 50% to 50% | 1 | | ns |
| t _d | Delay tim, PCLK until CTL0, CTL1, D1-D7, PINT | 50% to 50% | 0.5 | 7 | ns |

11.9 Electrical Characteristics Over Recommended Operating Conditions PHY Port Receiver

| PARAMETER | | TEST CONDITIONS | MIN | TYP | MAX | UNIT |
|-----------------------|---|--|------|-----|-----|------|
| Z _{ID} | Differential impedance | Drivers disabled | 4 | 7 | | kΩ |
| | | | | | 4 | pF |
| Z _{IC} | Common-mode impedance | Drivers disabled | 20 | | | kΩ |
| | | | | | 24 | pF |
| V _{TH-R} | Receiver input threshold voltage | Drivers disabled | -30 | | 30 | mV |
| V _{TH-CB} | Cable bias detect threshold. TPBx cable inputs | Drivers disabled | 0.6 | | 1 | V |
| V _{TH+} | Positive arbitration comparator threshold voltage | Drivers disabled | 89 | | 168 | mV |
| V _{TH-} | Negative arbitration comparator threshold voltage | Drivers disabled | -168 | | -89 | mV |
| V _{TH-SP200} | Speed signal threshold | TPBIAS-TPA common mode voltage, drivers disabled | 49 | | 131 | mV |
| V _{TH-SP400} | Speed signal threshold | TPBIAS-TPA common mode voltage, drivers disabled | 314 | | 396 | mV |

11.10 Jitter/Skew Characteristics for 1394a PHY Port Receiver

| PARAMETER | | MIN | TYP | MAX | UNIT |
|----------------------------|--|-----|-----|--------|------|
| 1394a Receive input jitter | TPA, TPB cable inputs, S100 operation | | | ±1.08 | ns |
| | TPA, TPB cable inputs, S200 operation | | | ±0.5 | |
| | TPA, TPB cable inputs, S400 operation | | | ±0.315 | |
| 1394a Receive input skew | Between TPA and TPB cable inputs, S100 operation | | | ±0.8 | ns |
| | Between TPA and TPB cable inputs, S200 operation | | | ±0.55 | |
| | Between TPA and TPB cable inputs, S400 operation | | | ±0.5 | |

11.11 Operating, Timing, and Switching Characteristics of XI

| PARAMETER | | MIN | TYP | MAX | UNIT |
|-----------------|---------------------------------|--------------------------|-----|-----|------|
| V _{IH} | High-level input voltage | 0.63 V _{DDA_33} | | | V |
| V _{IL} | Low-level input voltage | 0.33 V _{DDA_33} | | | V |
| | Input clock frequency | 98.304 | | | MHz |
| | Input clock frequency tolerance | <100 | | | ppm |
| | Input slew rate | 0.2 | | 4 | V/ns |
| | Input clock duty cycle | 40% | | 60% | |

11.12 Electrical Characteristics Over Recommended Operating Conditions (1394a Miscellaneous I/O)

| PARAMETER | | TEST CONDITIONS | MIN | TYP | MAX | UNIT |
|-----------------|---|---------------------------------|-------|-----|-------|------|
| V _{TH} | Power status threshold CPS input ⁽¹⁾ | 400-kΩ resistor ⁽¹⁾ | 4.7 | | 7.5 | V |
| V _O | TPBIAS output voltage | At rated I _O current | 1.665 | | 2.015 | V |
| I _O | TPBIAS output current | | -5.6 | | 1.3 | mA |

(1) Measure at cable power side of resistor.

12 Glossary

| ACRONYM | DEFINITION |
|----------------|---|
| BIST | Built-in self test |
| ECRC | End-to-end cyclic redundancy code |
| EEPROM | Electrically erasable programmable read-only memory |
| GP | General purpose |
| GPIO | General-purpose input output |
| ID | Identification |
| IF | Interface |
| IO | Input output |
| I2S | Inter IC sound |
| LPM | Link power management |
| LSB | Least significant bit |
| MSB | Most significant bit |
| MSI | Message signaled interrupts |
| PCI | Peripheral component interface |
| PME | PCI power management event |
| QoS | Quality-of-service |
| RX | Receive |
| SCL | Serial-bus clock |
| SDA | Serial-bus data |
| TC | Traffic class |
| TLP | Transaction layer packet or protocol |
| TX | Transmit |
| VC | Virtual channel |
| WRR | Weighted round-robin |

13 Mechanical Data

The XIO2213A device is available in a 167-ball ZAY PBGA. The following figures show the mechanical dimensions for the package.

XIO2213A PCI Express to 1394b OHCI with 3-Port PHY

SCPS183A—OCTOBER 2007—REVISED MARCH 2008



www.ti.com

PACKAGING INFORMATION

| Orderable Device | Status (1) | Package Type | Package Drawing | Pins | Package Qty | Eco Plan (2) | Lead finish/ Ball material (6) | MSL Peak Temp (3) | Op Temp (°C) | Device Marking (4/5) | Samples |
|------------------|---------------|--------------|--------------------|------|----------------|-----------------|--------------------------------------|----------------------|--------------|-------------------------|---------|
| XIO2213AZAY | NRND | NFBGA | ZAY | 167 | 160 | RoHS & Green | SNAGCU | Level-3-260C-168 HR | 0 to 70 | XIO2213AZAY | |

(1) The marketing status values are defined as follows:

ACTIVE: Product device recommended for new designs.

LIFEBUY: TI has announced that the device will be discontinued, and a lifetime-buy period is in effect.

NRND: Not recommended for new designs. Device is in production to support existing customers, but TI does not recommend using this part in a new design.

PREVIEW: Device has been announced but is not in production. Samples may or may not be available.

OBSELETE: TI has discontinued the production of the device.

(2) **RoHS:** TI defines "RoHS" to mean semiconductor products that are compliant with the current EU RoHS requirements for all 10 RoHS substances, including the requirement that RoHS substance do not exceed 0.1% by weight in homogeneous materials. Where designed to be soldered at high temperatures, "RoHS" products are suitable for use in specified lead-free processes. TI may reference these types of products as "Pb-Free".

RoHS Exempt: TI defines "RoHS Exempt" to mean products that contain lead but are compliant with EU RoHS pursuant to a specific EU RoHS exemption.

Green: TI defines "Green" to mean the content of Chlorine (Cl) and Bromine (Br) based flame retardants meet JS709B low halogen requirements of <=1000ppm threshold. Antimony trioxide based flame retardants must also meet the <=1000ppm threshold requirement.

(3) MSL, Peak Temp. - The Moisture Sensitivity Level rating according to the JEDEC industry standard classifications, and peak solder temperature.

(4) There may be additional marking, which relates to the logo, the lot trace code information, or the environmental category on the device.

(5) Multiple Device Markings will be inside parentheses. Only one Device Marking contained in parentheses and separated by a "-" will appear on a device. If a line is indented then it is a continuation of the previous line and the two combined represent the entire Device Marking for that device.

(6) Lead finish/Ball material - Orderable Devices may have multiple material finish options. Finish options are separated by a vertical ruled line. Lead finish/Ball material values may wrap to two lines if the finish value exceeds the maximum column width.

Important Information and Disclaimer:The information provided on this page represents TI's knowledge and belief as of the date that it is provided. TI bases its knowledge and belief on information provided by third parties, and makes no representation or warranty as to the accuracy of such information. Efforts are underway to better integrate information from third parties. TI has taken and continues to take reasonable steps to provide representative and accurate information but may not have conducted destructive testing or chemical analysis on incoming materials and chemicals. TI and TI suppliers consider certain information to be proprietary, and thus CAS numbers and other limited information may not be available for release.

In no event shall TI's liability arising out of such information exceed the total purchase price of the TI part(s) at issue in this document sold by TI to Customer on an annual basis.

TRAY



Chamfer on Tray corner indicates Pin 1 orientation of packed units.

*All dimensions are nominal

| Device | Package Name | Package Type | Pins | SPQ | Unit array matrix | Max temperature (°C) | L (mm) | W (mm) | K0 (µm) | P1 (mm) | CL (mm) | CW (mm) |
|-------------|--------------|--------------|------|-----|-------------------|----------------------|--------|--------|---------|---------|---------|---------|
| XIO2213AZAY | ZAY | NFBGA | 167 | 160 | 8 x 20 | 150 | 315 | 135.9 | 7620 | 15.4 | 11.2 | 19.65 |

ZAY (S-PBGA-N167)

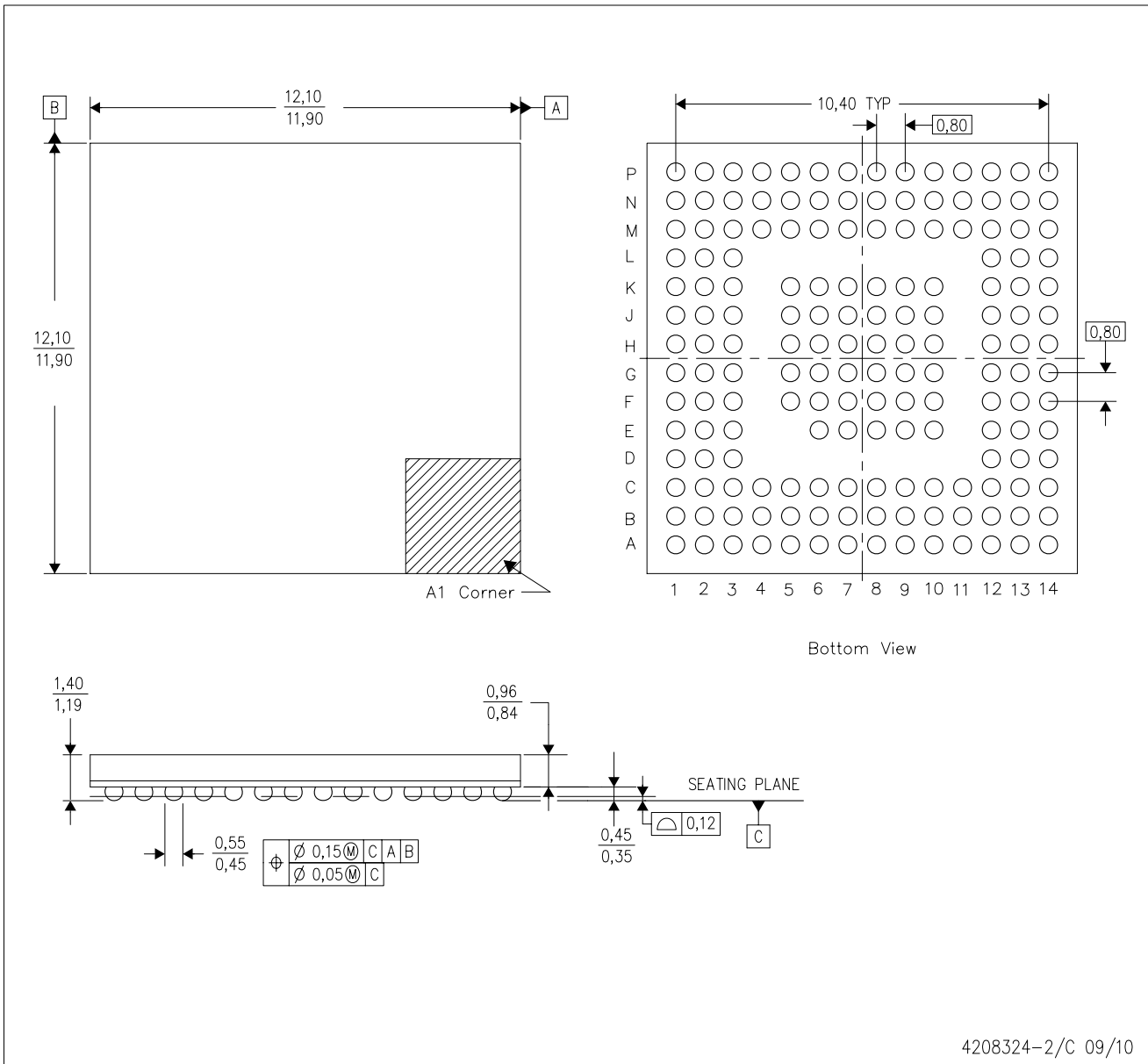
PLASTIC BALL GRID ARRAY



- NOTES:
- A. All linear dimensions are in millimeters. Dimensioning and tolerancing per ASME Y14.5M-1994.
 - B. This drawing is subject to change without notice.
 - C. This is a Pb-free solder ball design.

IMPORTANT NOTICE AND DISCLAIMER

TI PROVIDES TECHNICAL AND RELIABILITY DATA (INCLUDING DATA SHEETS), DESIGN RESOURCES (INCLUDING REFERENCE DESIGNS), APPLICATION OR OTHER DESIGN ADVICE, WEB TOOLS, SAFETY INFORMATION, AND OTHER RESOURCES "AS IS" AND WITH ALL FAULTS, AND DISCLAIMS ALL WARRANTIES, EXPRESS AND IMPLIED, INCLUDING WITHOUT LIMITATION ANY IMPLIED WARRANTIES OF MERCHANTABILITY, FITNESS FOR A PARTICULAR PURPOSE OR NON-INFRINGEMENT OF THIRD PARTY INTELLECTUAL PROPERTY RIGHTS.

These resources are intended for skilled developers designing with TI products. You are solely responsible for (1) selecting the appropriate TI products for your application, (2) designing, validating and testing your application, and (3) ensuring your application meets applicable standards, and any other safety, security, regulatory or other requirements.

These resources are subject to change without notice. TI grants you permission to use these resources only for development of an application that uses the TI products described in the resource. Other reproduction and display of these resources is prohibited. No license is granted to any other TI intellectual property right or to any third party intellectual property right. TI disclaims responsibility for, and you will fully indemnify TI and its representatives against, any claims, damages, costs, losses, and liabilities arising out of your use of these resources.

TI's products are provided subject to [TI's Terms of Sale](#) or other applicable terms available either on ti.com or provided in conjunction with such TI products. TI's provision of these resources does not expand or otherwise alter TI's applicable warranties or warranty disclaimers for TI products.

TI objects to and rejects any additional or different terms you may have proposed.

Mailing Address: Texas Instruments, Post Office Box 655303, Dallas, Texas 75265
Copyright © 2022, Texas Instruments Incorporated