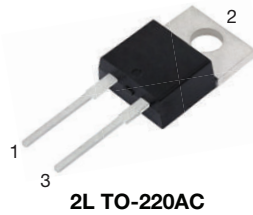
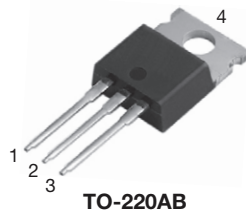
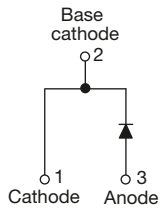
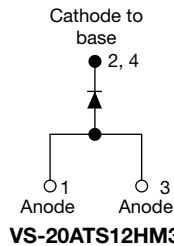

## High Voltage, Input Rectifier Diode, 20 A

**2L TO-220AC**

**TO-220AB**

**VS-20ETS12THM3**

**VS-20ATS12HM3**

### FEATURES

- Glass passivated pellet chip junction
- AEC-Q101 qualified
- Meets JESD 201 class 1A whisker test
- Flexible solution for reliable AC power rectification
- High surge, low  $V_F$  rugged blocking diode for DC charging stations
- Material categorization: for definitions of compliance please see [www.vishay.com/doc?99912](http://www.vishay.com/doc?99912)

**RoHS**  
 COMPLIANT  
 HALOGEN  
**FREE**

### APPLICATIONS

- On-board and off-board EV/HEV battery chargers
- Input rectification

### DESCRIPTION

High voltage rectifiers optimized for very low forward voltage drop with moderate leakage.

These devices are intended for use in main rectification (single or three phase bridge).

#### PRIMARY CHARACTERISTICS

$I_{F(AV)}$	20 A
$V_R$	1200 V
$V_F$ at $I_F$	1.1 V
$I_{FSM}$	300 A
$T_J$ max.	150 °C
Package	2L TO-220AC, 3L TO-220AB
Circuit configuration	Single, common anode

#### OUTPUT CURRENT IN TYPICAL APPLICATIONS

APPLICATIONS	SINGLE-PHASE BRIDGE	THREE-PHASE BRIDGE	UNITS
Capacitive input filter $T_A = 55$ °C, $T_J = 125$ °C common heatsink of 1 °C/W	16.3	21	A

#### MAJOR RATINGS AND CHARACTERISTICS

SYMBOL	CHARACTERISTICS	VALUES	UNITS
$I_{F(AV)}$	Sinusoidal waveform	20	A
$V_{RRM}$		1200	V
$I_{FSM}$		300	A
$V_F$	10 A, $T_J = 25$ °C	1.0	V
$T_J$		-40 to +150	°C

#### VOLTAGE RATINGS

PART NUMBER	$V_{RRM}$ , MAXIMUM PEAK REVERSE VOLTAGE V	$V_{RSM}$ , MAXIMUM NON-REPETITIVE PEAK REVERSE VOLTAGE V	$I_{RRM}$ AT 150 °C mA
VS-20ETS12THM3, VS-20ATS12HM3	1200	1300	1



ABSOLUTE MAXIMUM RATINGS				
PARAMETER	SYMBOL	TEST CONDITIONS	VALUES	UNITS
Maximum average forward current	$I_{F(AV)}$	$T_C = 105\text{ }^\circ\text{C}$ , 180° conduction half sine wave	20	A
Maximum peak one cycle non-repetitive surge current	$I_{FSM}$	10 ms sine pulse, rated $V_{RRM}$ applied	250	
		10 ms sine pulse, no voltage reapplied	300	
Maximum $I^2t$ for fusing	$I^2t$	10 ms sine pulse, rated $V_{RRM}$ applied	316	$A^2s$
		10 ms sine pulse, no voltage reapplied	442	
Maximum $I^2\sqrt{t}$ for fusing	$I^2\sqrt{t}$	$t = 0.1\text{ ms to }10\text{ ms}$ , no voltage reapplied	4420	$A^2\sqrt{s}$

ELECTRICAL SPECIFICATIONS				
PARAMETER	SYMBOL	TEST CONDITIONS	VALUES	UNITS
Maximum forward voltage drop	$V_{FM}$	20 A, $T_J = 25\text{ }^\circ\text{C}$	1.1	V
Forward slope resistance	$r_t$	$T_J = 150\text{ }^\circ\text{C}$	10.4	$m\Omega$
Threshold voltage	$V_{F(TO)}$		0.85	V
Maximum reverse leakage current	$I_{RM}$	$T_J = 25\text{ }^\circ\text{C}$	0.1	mA
		$T_J = 150\text{ }^\circ\text{C}$	1.0	

THERMAL - MECHANICAL SPECIFICATIONS				
PARAMETER	SYMBOL	TEST CONDITIONS	VALUES	UNITS
Maximum junction and storage temperature range	$T_J, T_{Stg}$		-40 to +150	$^\circ\text{C}$
Maximum thermal resistance, junction to case	$R_{thJC}$	DC operation	1.3	$^\circ\text{C/W}$
Typical thermal resistance, case to heatsink	$R_{thCS}$	Mounting surface, smooth, and greased	0.5	
Approximate weight			2	g
			0.07	oz.
Mounting torque	minimum		6 (5)	$\text{kgf} \cdot \text{cm}$ $(\text{lbf} \cdot \text{in})$
	maximum		12 (10)	
Marking device		Case style 2L TO-220AC	20ETS12TH	
		Case style 3L TO-220AB	20ATS12H	

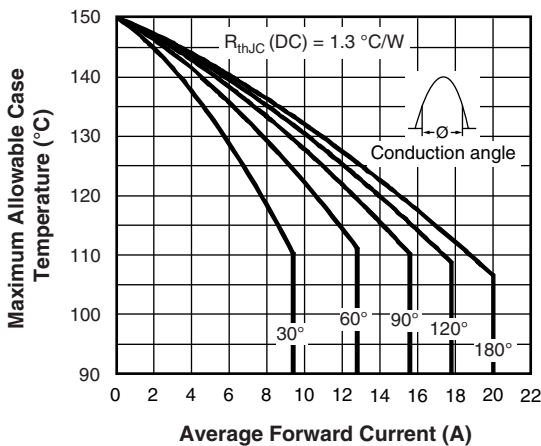

Fig. 1 - Current Rating Characteristics

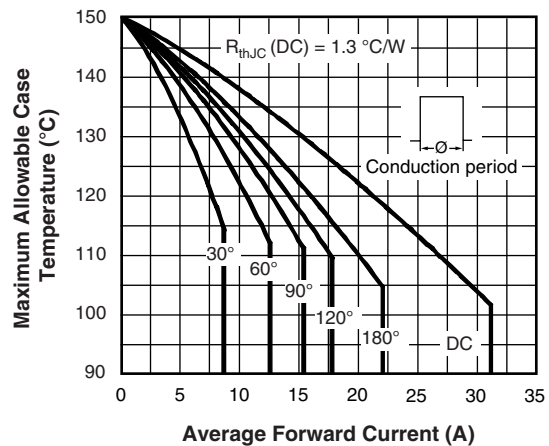

Fig. 2 - Current Rating Characteristics

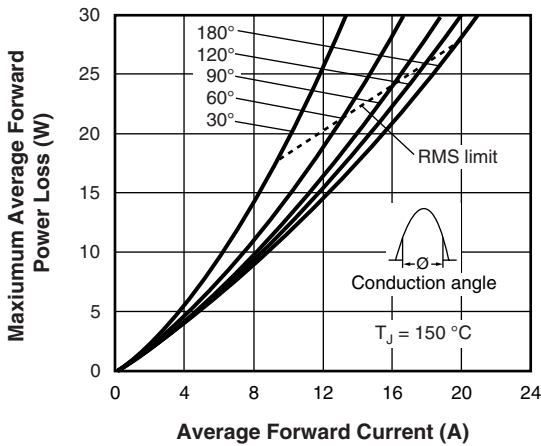

Fig. 3 - Forward Power Loss Characteristics

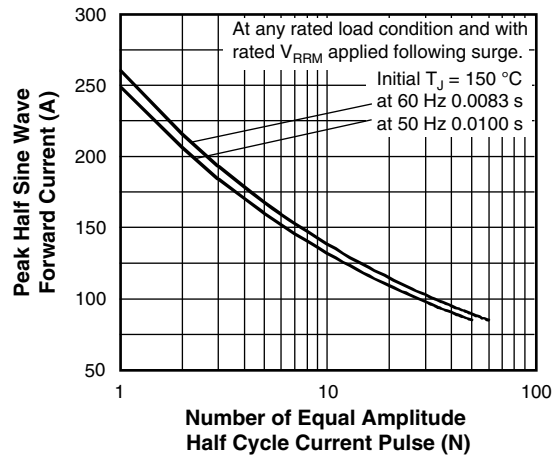

Fig. 5 - Maximum Non-Repetitive Surge Current

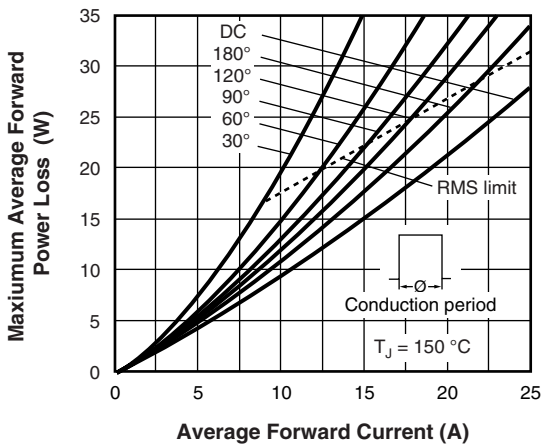

Fig. 4 - Forward Power Loss Characteristics

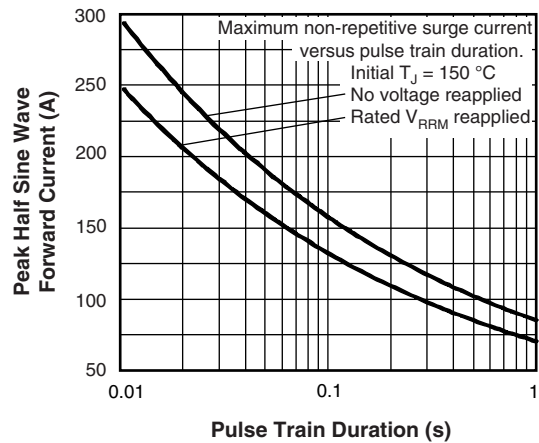

Fig. 6 - Maximum Non-Repetitive Surge Current

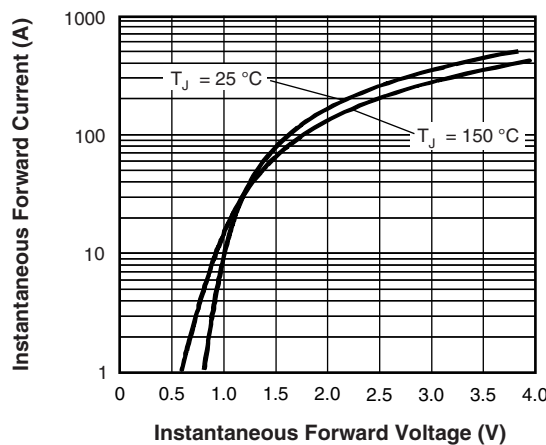

Fig. 7 - Forward Voltage Drop Characteristics

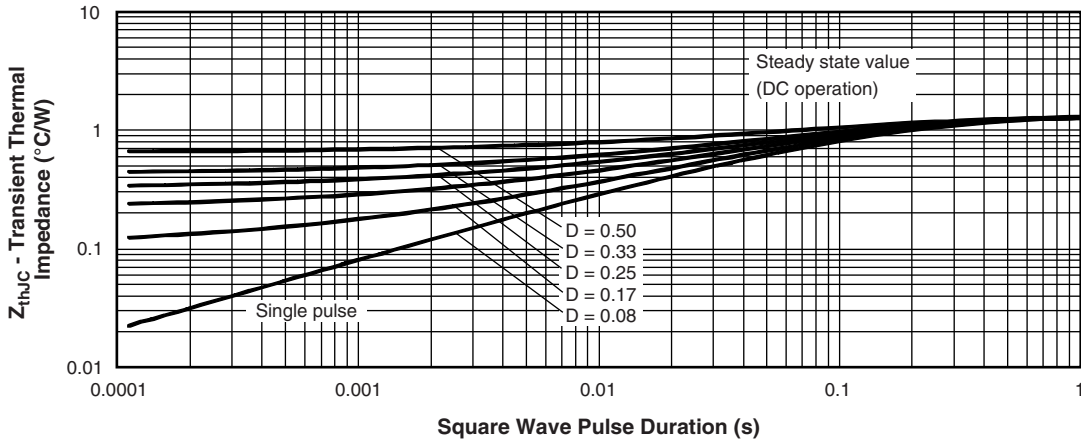

Fig. 8 - Thermal Impedance  $Z_{thJC}$  Characteristics

**ORDERING INFORMATION TABLE**

Device code	<b>VS-</b>	<b>20</b>	<b>E</b>	<b>T</b>	<b>S</b>	<b>12</b>	<b>T</b>	<b>H</b>	<b>M3</b>
	1	2	3	4	5	6	7	8	9

- 1** - Vishay Semiconductors product
- 2** - Current rating (20 = 20 A)
- 3** - Circuit configuration:  
E = 2L TO-220AC  
A = 3L TO-220AB
- 4** - Package:  
T = TO-220
- 5** - Type of silicon:  
S = standard recovery rectifier
- 6** - Voltage code x 100 =  $V_{RRM}$  ——— **12 = 1200 V**
- 7** -
  - None = TO-220AB
  - T = True pin TO-220
- 8** - H = AEC-Q101 qualified
- 9** - Environmental digit:  
M3 = halogen-free, RoHS-compliant, and terminations lead (Pb)-free

ORDERING INFORMATION (Example)			
PREFERRED P/N	QUANTITY PER T/R	MINIMUM ORDER QUANTITY	PACKAGING DESCRIPTION
VS-20ETS12THM3	50	1000	Antistatic plastic tubes
VS-20ATS12HM3	50	1000	Antistatic plastic tubes

LINKS TO RELATED DOCUMENTS			
Dimensions	2L TO-220AC	<a href="http://www.vishay.com/doc?96069">www.vishay.com/doc?96069</a>	
	3L TO-220AB	<a href="http://www.vishay.com/doc?95222">www.vishay.com/doc?95222</a>	
Part marking information	2L TO-220AC	<a href="http://www.vishay.com/doc?95391">www.vishay.com/doc?95391</a>	
	3L TO-220AB	<a href="http://www.vishay.com/doc?95028">www.vishay.com/doc?95028</a>	



SPICE model	<a href="http://www.vishay.com/doc?96046">www.vishay.com/doc?96046</a>
-------------	--

### TO-220AB

**DIMENSIONS** in millimeters and inches



Conforms to JEDEC® outline TO-220AB

SYMBOL	MILLIMETERS		INCHES		NOTES	SYMBOL	MILLIMETERS		INCHES		NOTES
	MIN.	MAX.	MIN.	MAX.			MIN.	MAX.	MIN.	MAX.	
A	4.25	4.65	0.167	0.183		D2	11.68	12.88	0.460	0.507	6
A1	1.14	1.40	0.045	0.055		E	10.11	10.51	0.398	0.414	3, 6
A2	2.56	2.92	0.101	0.115		E1	6.86	8.89	0.270	0.350	6
b	0.69	1.01	0.027	0.040		E2	-	0.76	-	0.030	7
b1	0.38	0.97	0.015	0.038	4	e	2.41	2.67	0.095	0.105	
b2	1.20	1.73	0.047	0.068		e1	4.88	5.28	0.192	0.208	
b3	1.14	1.73	0.045	0.068	4	H1	5.84	6.86	0.230	0.270	6, 7
c	0.36	0.61	0.014	0.024		L	13.52	14.02	0.532	0.552	
c1	0.36	0.56	0.014	0.022	4	L1	3.32	3.82	0.131	0.150	2
D	14.85	15.25	0.585	0.600	3	∅ P	3.54	3.73	0.139	0.147	
D1	8.38	9.02	0.330	0.355		Q	2.60	3.00	0.102	0.118	

**Notes**

- (1) Dimensioning and tolerancing as per ASME Y14.5M-1994
- (2) Lead dimension and finish uncontrolled in L1
- (3) Dimension D, D1 and E do not include mold flash. Mold flash shall not exceed 0.127 mm (0.005") per side. These dimensions are measured at the outermost extremes of the plastic body
- (4) Dimension b1, b3 and c1 apply to base metal only
- (5) Controlling dimensions: inches
- (6) Thermal pad contour optional within dimensions E, H1, D2 and E1
- (7) Dimensions E2 x H1 define a zone where stamping and singulation irregularities are allowed
- (8) Outline conforms to JEDEC® TO-220, except A2 (maximum) and D2 (minimum) where dimensions are derived from the actual package outline

### 2L TO-220AC

**DIMENSIONS** in millimeters and inches

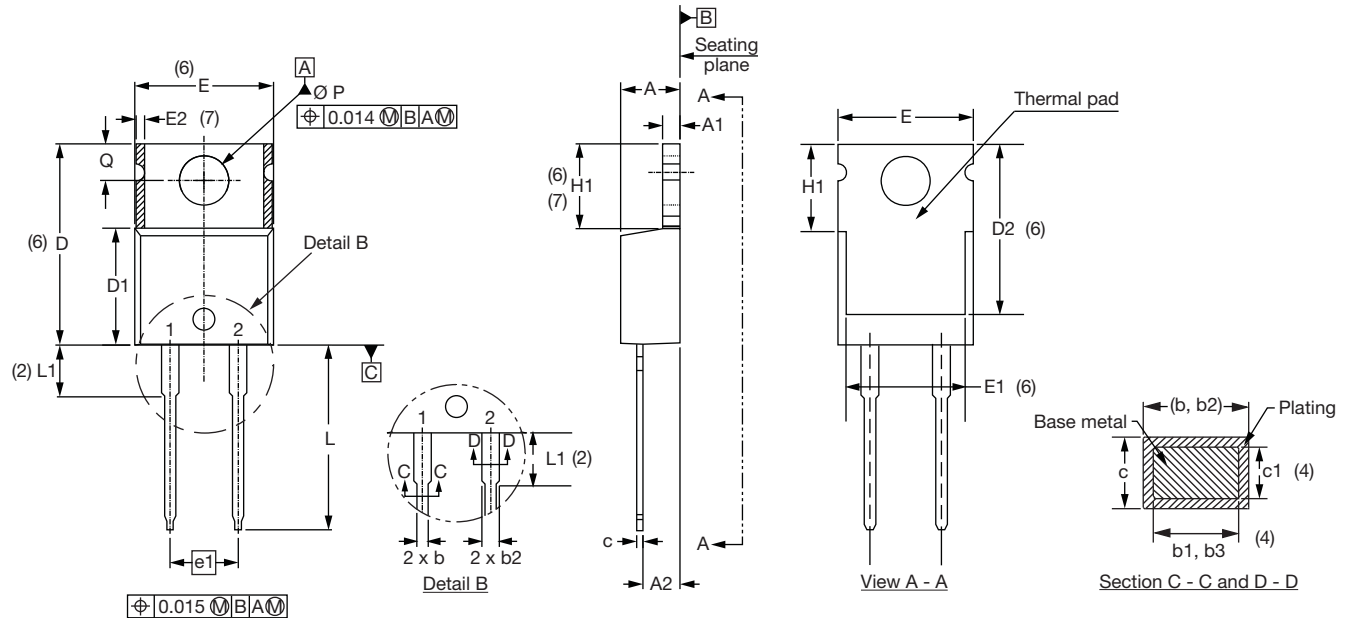

SYMBOL	MILLIMETERS		INCHES		NOTES
	MIN.	MAX.	MIN.	MAX.	
A	4.25	4.65	0.167	0.183	
A1	1.14	1.40	0.045	0.055	
A2	2.56	2.92	0.101	0.115	
b	0.69	1.01	0.027	0.040	
b1	0.38	0.97	0.015	0.038	4
b2	1.20	1.73	0.047	0.068	
b3	1.14	1.73	0.045	0.068	4
c	0.36	0.61	0.014	0.024	
c1	0.36	0.56	0.014	0.022	4
D	14.85	15.25	0.585	0.600	3
D1	8.38	9.02	0.330	0.355	
D2	11.68	12.88	0.460	0.507	6
E	10.11	10.51	0.398	0.414	3, 6

SYMBOL	MILLIMETERS		INCHES		NOTES
	MIN.	MAX.	MIN.	MAX.	
E1	6.86	8.89	0.270	0.350	6
E2	-	0.76	-	0.030	7
e1	4.88	5.28	0.192	0.208	
H1	5.84	6.86	0.230	0.270	6, 7
L	13.52	14.02	0.532	0.552	
L1	3.32	3.82	0.131	0.150	2
$\Phi$ P	3.54	3.73	0.139	0.147	
Q	2.60	3.00	0.102	0.118	

**Notes**

- (1) Dimensioning and tolerancing as per ASME Y14.5M-1994
- (2) Lead dimension and finish uncontrolled in L1
- (3) Dimension D, D1 and E do not include mold flash. Mold flash shall not exceed 0.127 mm (0.005") per side. These dimensions are measured at the outermost extremes of the plastic body
- (4) Dimension b1, b3 and c1 apply to base metal only
- (5) Controlling dimension: inches
- (6) Thermal pad contour optional within dimensions E, H1, D2 and E1
- (7) Dimension E2 x H1 define a zone where stamping and singulation irregularities are allowed
- (8) Outline conforms to JEDEC® TO-220, except D2, where JEDEC® minimum is 0.480"



## **Disclaimer**

ALL PRODUCT, PRODUCT SPECIFICATIONS AND DATA ARE SUBJECT TO CHANGE WITHOUT NOTICE TO IMPROVE RELIABILITY, FUNCTION OR DESIGN OR OTHERWISE.

Vishay Intertechnology, Inc., its affiliates, agents, and employees, and all persons acting on its or their behalf (collectively, "Vishay"), disclaim any and all liability for any errors, inaccuracies or incompleteness contained in any datasheet or in any other disclosure relating to any product.

Vishay makes no warranty, representation or guarantee regarding the suitability of the products for any particular purpose or the continuing production of any product. To the maximum extent permitted by applicable law, Vishay disclaims (i) any and all liability arising out of the application or use of any product, (ii) any and all liability, including without limitation special, consequential or incidental damages, and (iii) any and all implied warranties, including warranties of fitness for particular purpose, non-infringement and merchantability.

Statements regarding the suitability of products for certain types of applications are based on Vishay's knowledge of typical requirements that are often placed on Vishay products in generic applications. Such statements are not binding statements about the suitability of products for a particular application. It is the customer's responsibility to validate that a particular product with the properties described in the product specification is suitable for use in a particular application. Parameters provided in datasheets and / or specifications may vary in different applications and performance may vary over time. All operating parameters, including typical parameters, must be validated for each customer application by the customer's technical experts. Product specifications do not expand or otherwise modify Vishay's terms and conditions of purchase, including but not limited to the warranty expressed therein.

Except as expressly indicated in writing, Vishay products are not designed for use in medical, life-saving, or life-sustaining applications or for any other application in which the failure of the Vishay product could result in personal injury or death. Customers using or selling Vishay products not expressly indicated for use in such applications do so at their own risk. Please contact authorized Vishay personnel to obtain written terms and conditions regarding products designed for such applications.

No license, express or implied, by estoppel or otherwise, to any intellectual property rights is granted by this document or by any conduct of Vishay. Product names and markings noted herein may be trademarks of their respective owners.