

SPDE



Single Phase Compact Power Supply



Benefits

- **Compact dimensions:** SPDE can save up to 50% panel-width space thanks to its ultra-slim design. The 480 W model is just 48 mm wide.
- **High efficiency:** The built-in PFC (on SPDE..R models) results in high operating efficiency up to 94%.
- **Flexible installation:** Universal AC/DC input range with AC voltage (90 VAC to 264 VAC) or with DC voltage (120 VDC to 370 VDC).
- **Integrated protection:** Output short circuit, over-current, over-voltage, over-temperature protection.
- **Wide operating temperature:** SPDE..R models can work in extreme temperatures from -40°C to +70°C (-40°F to +158°F).

Description

The SPDE series of DIN-rail mount power supplies encompasses high performance within an extremely compact footprint. Power ratings start from 75 W up to 480 W with 12, 24 and 48 VDC output. The SPDE achieves high operating efficiency of up to 94% @ 230 VAC. Features such as DC ok output relay (for SPDE..R models) and built-in protection functions ensure a high degree of reliability during operation.

All specifications are at nominal values, full load, 25°C unless otherwise stated.

Applications

Installations with limited panel space, industrial equipment, machinery.

Main functions

- Output short circuit, over-current, over-voltage and over-temperature protection
- DC OK relay indication (only in SPDE..R models)
- Built-in active PFC (only in SPDE..R models)

References

Order code



SPDE 1



Enter the code entering the corresponding option instead of .

Code	Option	Description	Notes
S	-	Switching	Device typology
P	-	Power	
D	-	DIN rail	
E	-	High efficiency	Mounting
<input type="checkbox"/>	12	12 VDC	
	24	24 VDC	
	48	48 VDC	
<input type="checkbox"/>	75	75 W	Rated output power
	120	120 W	
	190	192 W	
	240	240 W	
	480	480 W	
1	-	Single phase input	Input type
<input type="checkbox"/>	-	-	
	R	Relay output	

Selection guide

Output Voltage	SPDE..75	SPDE..120	SPDE..190	SPDE..240	SPDE..480
12 VDC	SPDE12751	SPDE121201R	SPDE121901R	-	-
24 VDC	SPDE24751	SPDE241201 SPDE241201R	-	SPDE242401 SPDE242401R	SPDE244801R
48 VDC	SPDE48751	SPDE481201R	-	SPDE482401R	SPDE484801R

Further reading

Information	Where to find it	QR code
SPDE datasheet	https://gavazziautomation.com/images/PIM/DATASHEET/ENG/SPDE_DS_EN.pdf	
SPDE installation sheet	https://gavazziautomation.com/images/PIM/MANUALS/ENG/SPDE_IM.pdf	

Structure

SPDE..75 / SPDE..120 / SPDE..190 / SPDE..240

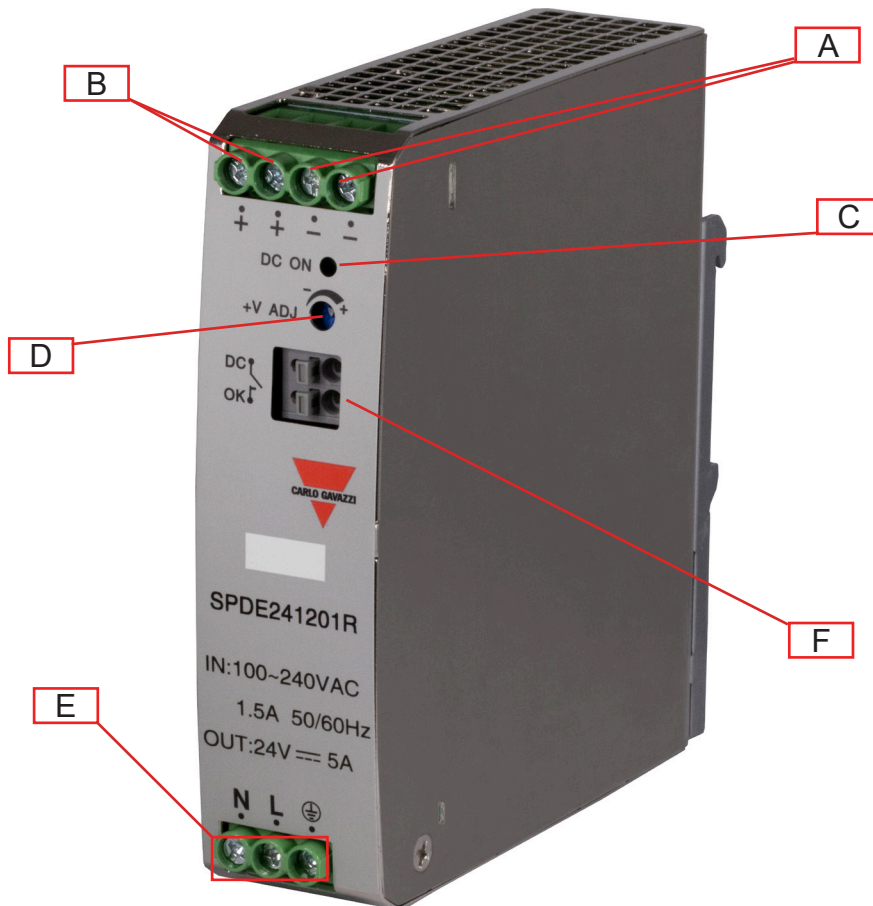

Element	Component	Function
A	- V terminals	Negative DC Output terminals
B	+ V terminals	Positive DC Output terminals
C	DC OK LED	Green when output voltage is active
D	VADJ trimmer	Output voltage adjustment
E	Input terminals	L, N supply terminals and Protective Earth (PE)
F	DC OK relay*	Relay rating: 30 VDC / 1 A max. (resistive load) Relay contacts closed when output voltage \geq 90% of rated output voltage.

* applies to SPDE..R models only

SPDE..480..R

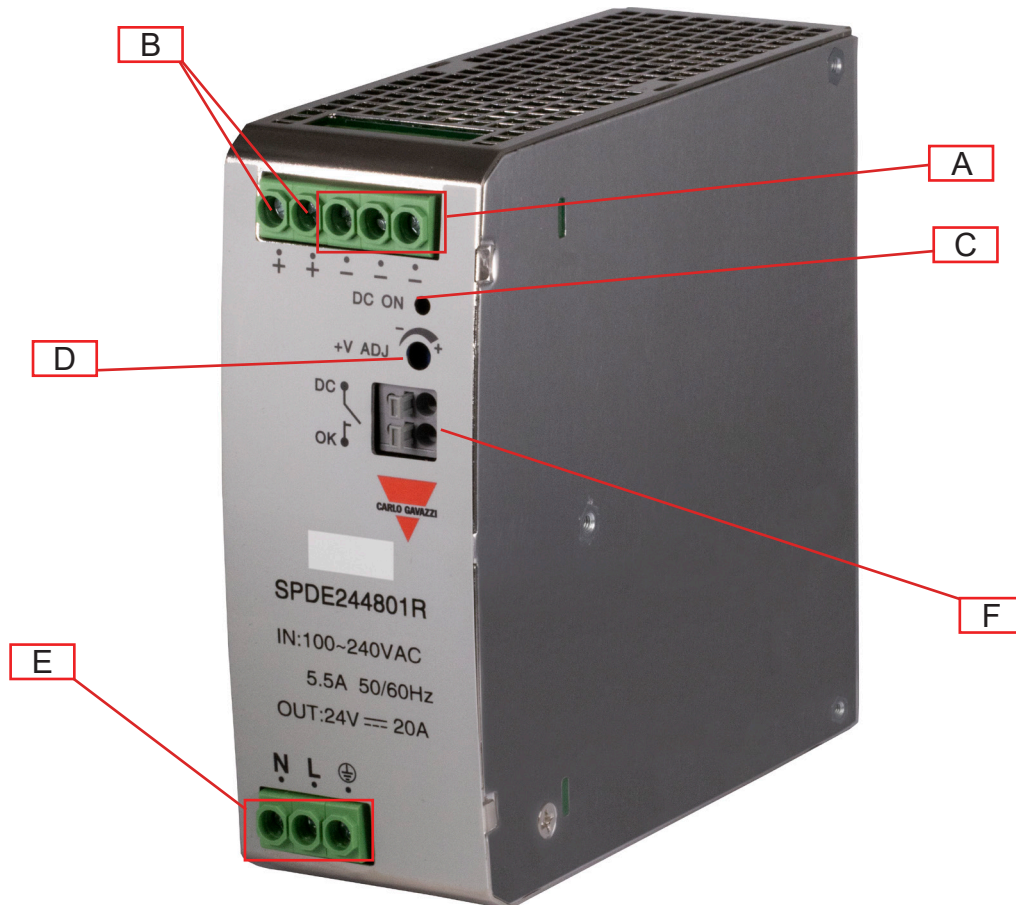

Element	Component	Function
A	- V terminals	Negative DC Output terminals
B	+ V terminals	Positive DC Output terminals
C	DC OK LED	Green when output voltage is active
D	VADJ trimmer	Output voltage adjustment
E	Input terminals	L, N supply terminals and Protective Earth (PE)
F	DC OK relay	Relay rating: 30 VDC / 1 A max. (resistive load) Relay contacts closed when output voltage \geq 90% of rated output voltage.

Features

General data

	SPDE..75	SPDE..120	SPDE..190	SPDE..240	SPDE..480
Leakage current (input-output)	<0.5 mA	<1.0 mA	<0.5 mA		<0.8 mA
Earth leakage current (input-GND)		-	<1.0 mA		-
Efficiency	86% (12 VDC) 89% (24 VDC) 90% (48 VDC)	88%* 93.5% (12 VDC) 94% (24 VDC) 94% (48 VDC)	92% (12 VDC)	94% (24 VDC) 94% (48 VDC)	94% (24 VDC) 94% (48 VDC)
Power loss @ nominal load	≤1.5W	-			
Power factor (full load)					
115 VAC	-	0.98		0.98	0.99
230 VAC		0.94		0.94 / 0.95*	0.99
Ingress protection	IP20				
MTBF (MIL-HDBK-217F)	>300,000 h				
Case material	Metal				
Weight	350 g	410 g* 490 g ± 10%	600 g	600 g** 650 g	980 g

* applies to SPDE241201 only

** applies to SPDE242401 only

Dimensions

SPDE..75

Unit: mm [inch]

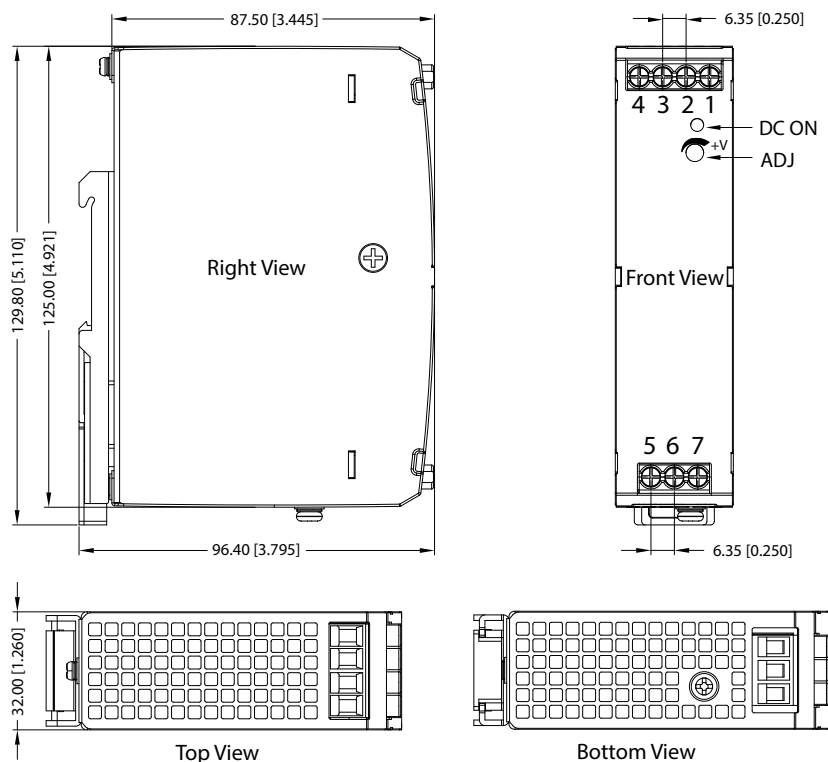

SPDE..120
Unit: mm [inch]

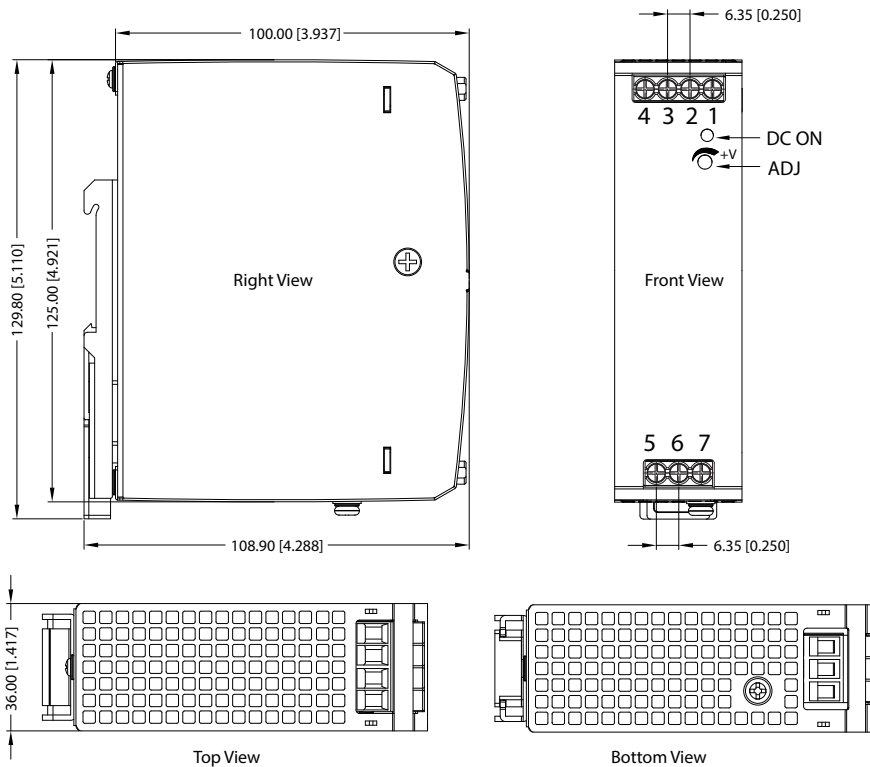

SPDE..120..R
Unit: mm [inch]

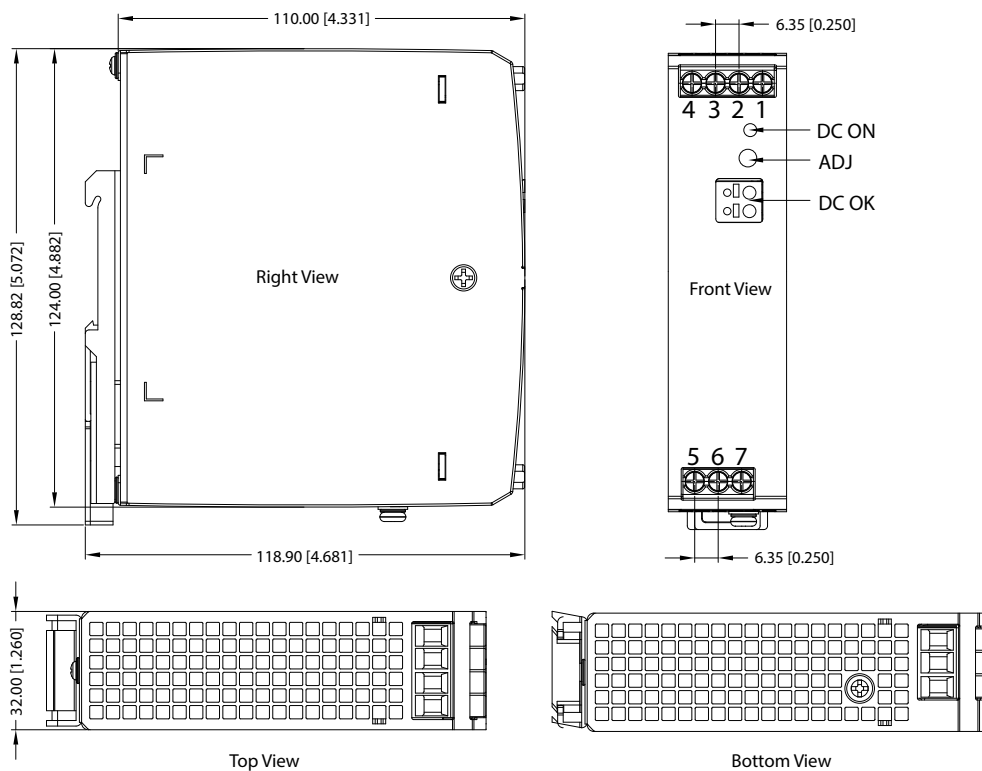

SPDE242401
Unit: mm [inch]

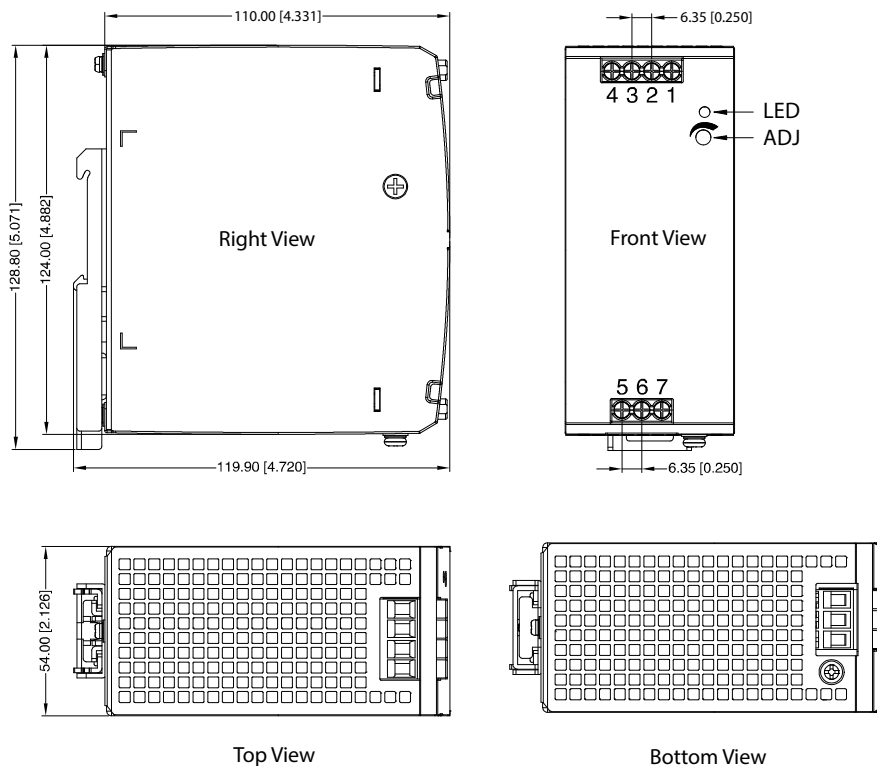

SPDE..190..R / SPDE..240..R
Unit: mm [inch]

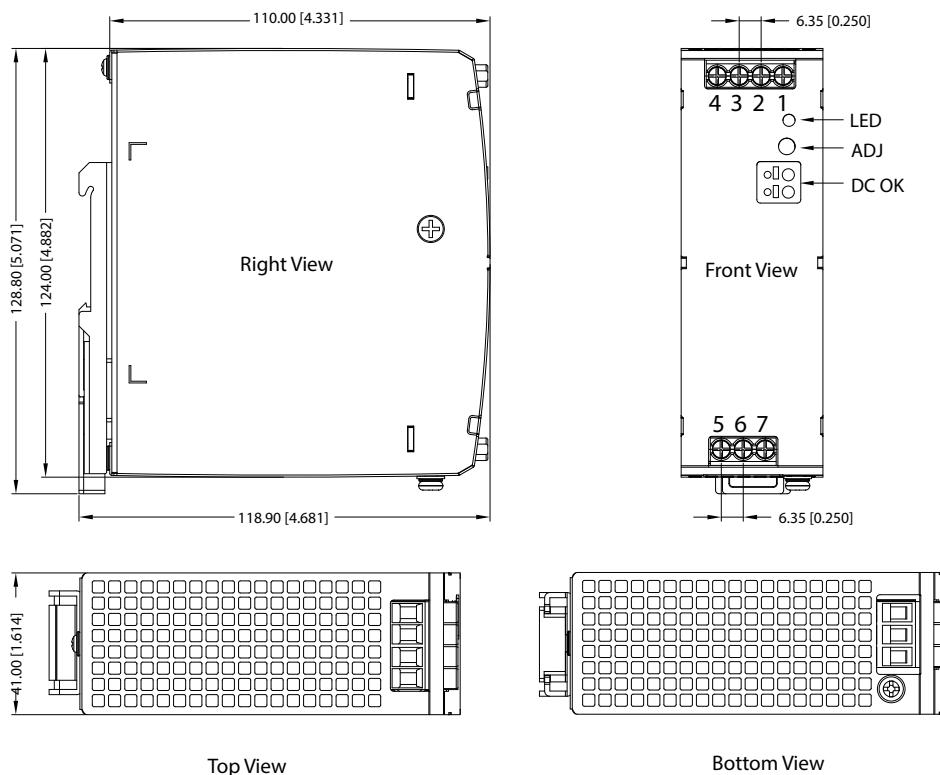

SPDE..480..R
 Unit: mm [inch]

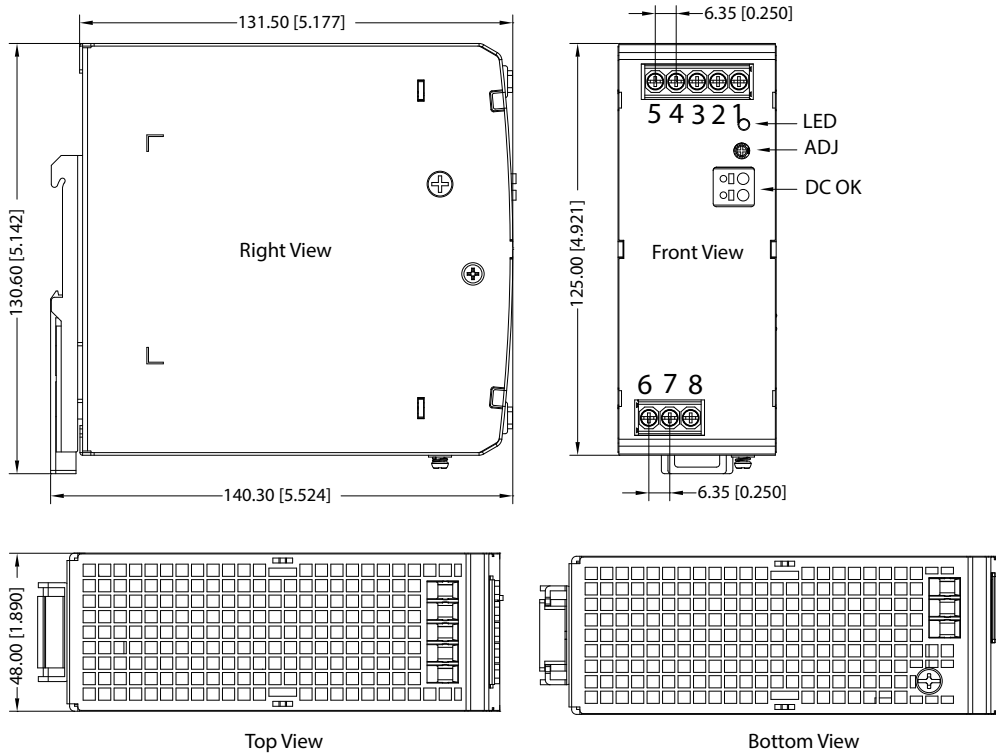

Connection diagram

Terminal markings

SPDE..75 / SPDE..120 / SPDE..190 / SPDE..240

Terminal	Designation	Description
1	-V _o	Negative output terminal
2	-V _o	Negative output terminal
3	+V _o	Positive output terminal
4	+V _o	Positive output terminal
5	AC(N)	Input terminals (neutral conductor, no polarity with DC input)
6	AC(L)	Input terminals (phase conductor, no polarity with DC input)
7	PE	Ground this terminal to minimize high frequency emissions

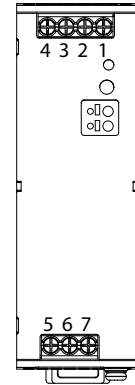

SPDE..480

Terminal	Designation	Description
1	-V _o	Negative output terminal
2	-V _o	Negative output terminal
3	-V _o	Negative output terminal
4	+V _o	Positive output terminal
5	+V _o	Positive output terminal
6	AC(N)	Input terminals (neutral conductor, no polarity with DC input)
7	AC(L)	Input terminals (phase conductor, no polarity with DC input)
8	PE	Ground this terminal to minimize high frequency emissions

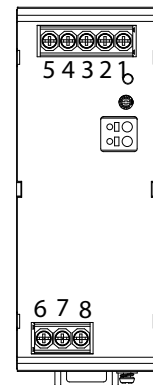

Environmental

	SPDE..75	SPDE..120	SPDE..190	SPDE..240	SPDE..480
Operating temperature	-30°C to 70°C -22°F to 158°F	-20°C to 60°C* -4°F to 140°F* -40°C to 70°C -40°F to 158°F	-40°C to 70°C -40°F to 158°F		-30°C to 70°C -22°F to 158°F
Storage temperature	-40°C to 85°C -40°F to 185°F				
Humidity	<95% RH Non-condensing				
Temperature derating	Refer to derating diagram				

* applies to SPDE241201 only

Compatibility and conformity

	SPDE..75	SPDE..120	SPDE..190	SPDE..240	SPDE..480
Safety standards	UL/EN62368-1 UL61010-1	EN62368-1 ¹ UL61010-1 ¹ UL61010-2-201	EN62368-1 UL61010-1 UL61010-2-201		EN62368-1 UL61010-1
Approvals					
Conducted (CS) IEC/EN 61000-4-6	10 Vrms (PC A)				
Voltage dips and interruptions IEC/EN61000-4-11	0% (PC B) 70% (PC B)				0% (PC A) 70% (PC A)
EMC emission CE: CISPR32/EN55032 RE: CISPR32/EN55032	CLASS B CLASS B	CLASS A CLASS A	CLASS B CLASS B		
Harmonic current	IEC/EN61000-3-2 CLASS A		IEC/EN61000-3-2 CLASS A and CLASS D		
EMC immunity	EN61000-4-2, EN61000-4-3, EN61000-4-4, EN61000-4-5, EN61000-4-6, EN61000-4-11				
Vibration resistance	10 ~ 500 Hz, 2G, 10 min. / 1 cycle, period for 60 min. Each along X, Y, Z axes.				
Semi F47	Tolerated sags to 50% of equipment nominal voltage for duration of up to 200 ms				

- 1. applies to SPDE241201 only
- 2. applies to SPDE..75 only

Insulation

	SPDE..75	SPDE..120	SPDE..190	SPDE..240	SPDE..480
Insulation / withstand voltage (input / GND)	2.0 kVAC / < 10 mA	2.0 kVAC / < 10 mA* 1.5 kVAC / < 15 mA	2.0 kVAC / < 15 mA		2.0 kVAC / < 10 mA
Insulation / withstand voltage (input / output)	4.0 kVAC / < 10 mA	4.0 kVAC / < 10 mA* 3.0 kVAC / < 15 mA	3.0 kVAC / < 15 mA		3.0 kVAC / < 10 mA
Insulation / withstand voltage (output / GND)	0.5 kVAC / < 10 mA	0.5 kVAC / < 10 mA* 0.5 kVAC / < 15 mA	0.5 kVAC / < 15 mA		0.5 kVAC / < 10 mA
Output / DC OK³	-	30 VDC / 1A max. (resistive load)			
Insulation resistance	≥ 50 MΩ	≥ 100 MΩ	≥ 50 MΩ		≥ 100 MΩ
Overvoltage category	II				
Pollution degree	2				

- 3. applies to SPDE..R models only
- * applies to SPDE241201 only

Inputs

	SPDE..75	SPDE..120	SPDE..190	SPDE..240	SPDE..480
Rated input voltage	100 VAC to 240 VAC				
Input voltage range	90 VAC to 264 VAC		85 VAC to 264 VAC		
	120 VDC to 370 VDC	127 VDC to 370 VDC	120 VDC to 370 VDC		
AC current (max) 115 VAC 230 VAC	<2.0 A <1.0 A	<3.0 A* / <1.5 A <1.6 A* / <0.75 A	<3.0 A <1.5 A		<5.5 A <2.5 A
Frequency range	47 Hz to 63 Hz				
Inrush current 115 VAC 230 VAC	25 A 45 A	30 A* / 15 A 55 A* / 30 A	15 A 30 A		20 A 40 A

* applies to SPDE241201 only

Outputs

	SPDE..75	SPDE..120	SPDE..190	SPDE..240	SPDE..480
Output power	75 W	120 W	192 W	240 W	480 W
Voltage accuracy	±2 % (12 VDC) ±1 % (24/48 VDC)		±2 %	±1 %	±1%
Line regulation	±0.5 %				
Load regulation	±1.0 %				
Voltage regulation span					
12 VDC	12 V to 14 V	12 V to 14 V	12 V to 14 V		
24 VDC	24 V to 28 V	24 V to 28 V		24 V to 28 V	24 V to 28 V
48 VDC	48 V to 53 V	48 V to 55 V		48 V to 53 V	48 V to 56 V
Rated output current					
12 VDC	6.3 A	10 A	16 A		
24 VDC	3.2 A	5 A		10 A	20 A
48 VDC	1.6 A	2.5 A		5 A	10 A
Ripple and noise 20 MHz bandwidth					
12 VDC	< 80 mV	< 120 mV* < 100 mV	75 - 150 mV	75 - 150 mV**	
24 VDC	< 120 mV	< 100 mV		60 - 120 mV	<100 mV
48 VDC	< 150 mV	< 200 mV		75 - 150 mV	<120 mV
Hold up time	≥ 12 ms (115 VAC) ≥ 60 ms (230 VAC)	≥ 8 ms (115 VAC)* ≥ 16 ms (230 VAC)* ≥ 20 ms		≤ 20 ms	≤ 22 ms
Set-up time	< 3 s	2.5 s (115 VAC)* 1.2 s (230 VAC)* < 3 s		< 1 s	< 3 s
Rise time	-	≤ 60 ms* ≤ 100 ms		< 100 ms	< 150 ms
Turn-on overshoot	< 10 %				
Overshoot and undershoot	±10%		< 10 %		±10%
Series operation	Support output series boost voltage, it is suggested 15 mm space				
Parallel operation	No				
Power boost	-	110%~150% of rated output current within 1 s* / 3 s	150% of rated output current		110%~150% of rated output current within 1 s

* applies to SPDE241201 only
 ** applies to SPDE242401 only

Performance

Current derating

SPDE..75

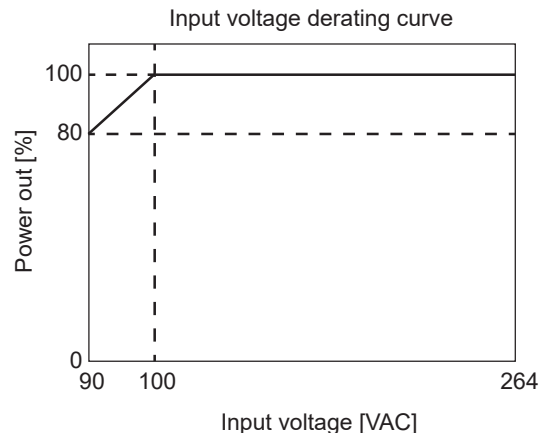
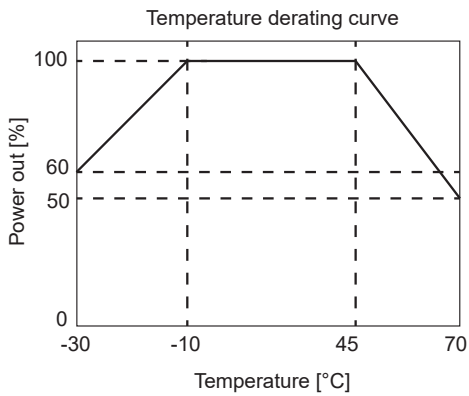

SPDE241201

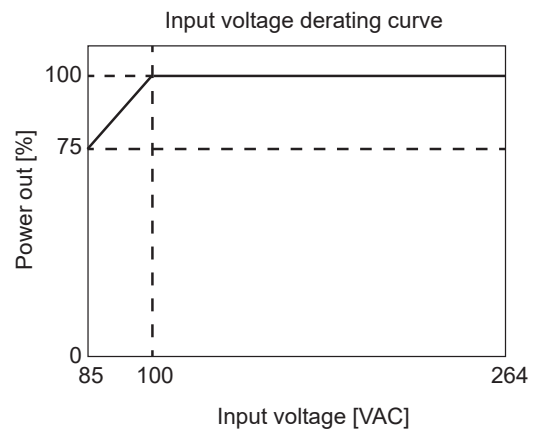
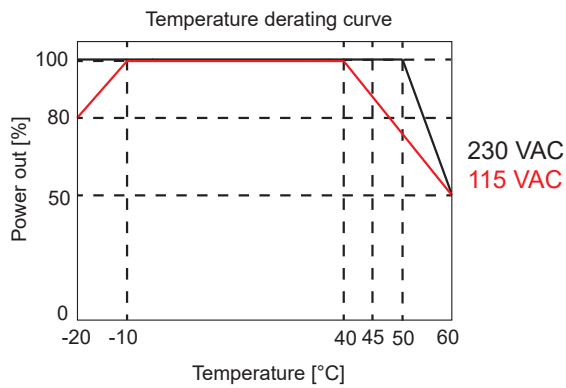

SPDE..120

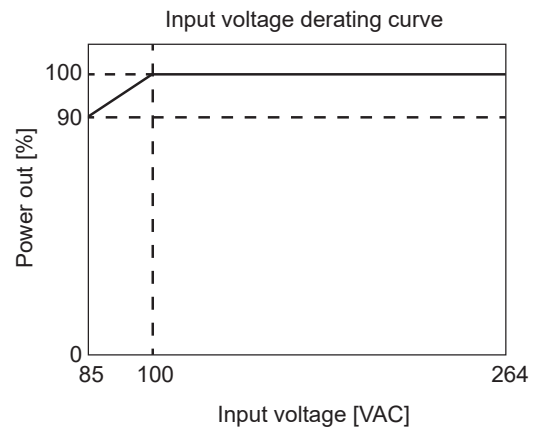
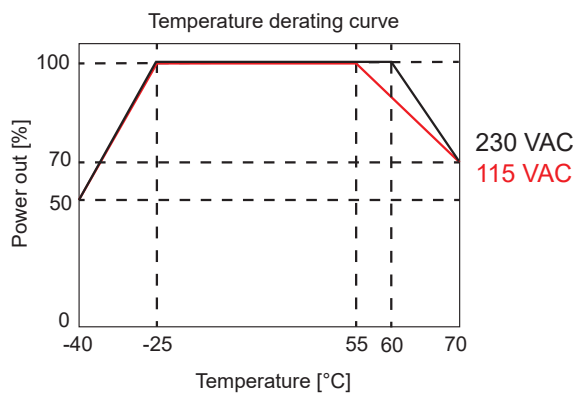

SPDE..190

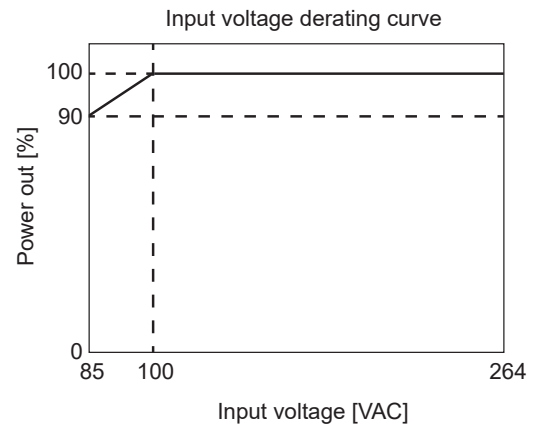
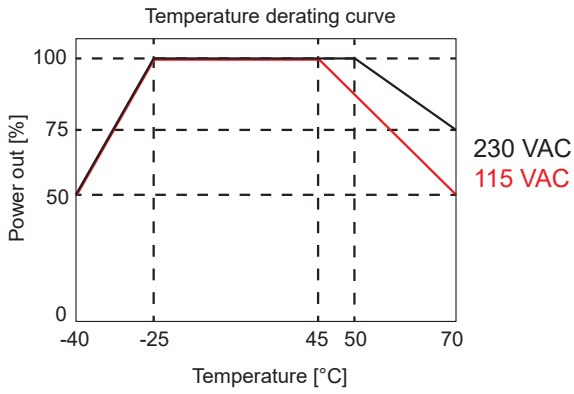

SPDE242401

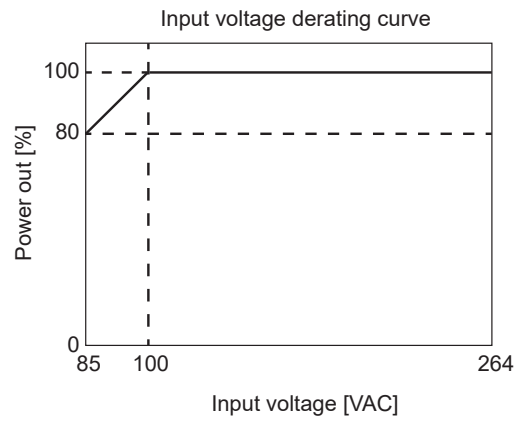
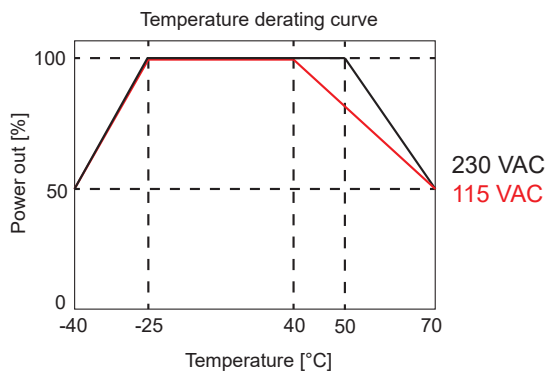

SPDE..240

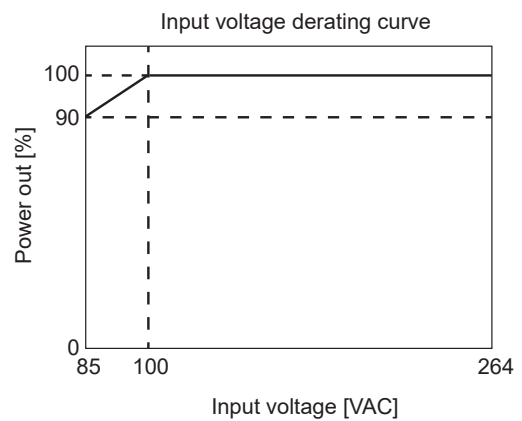
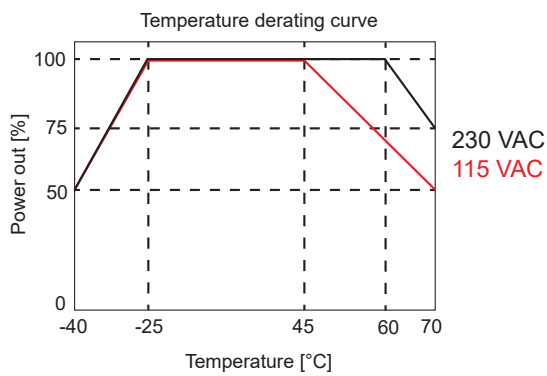

SPDE..480

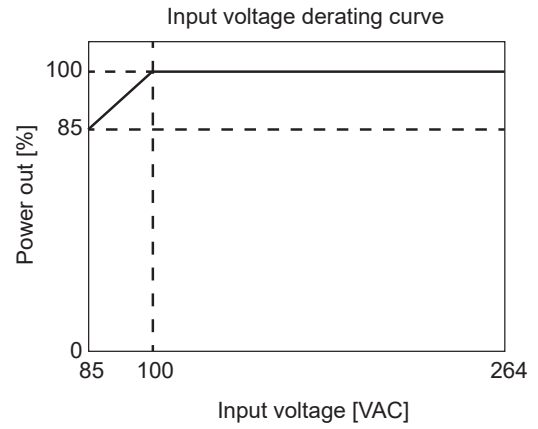
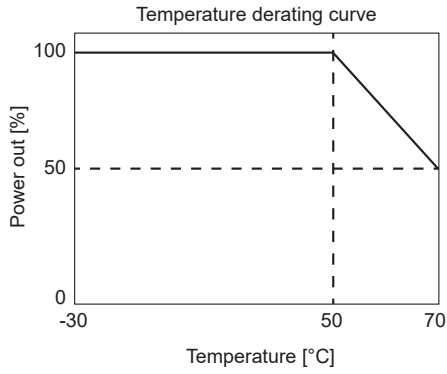

Efficiency

SPDE..75

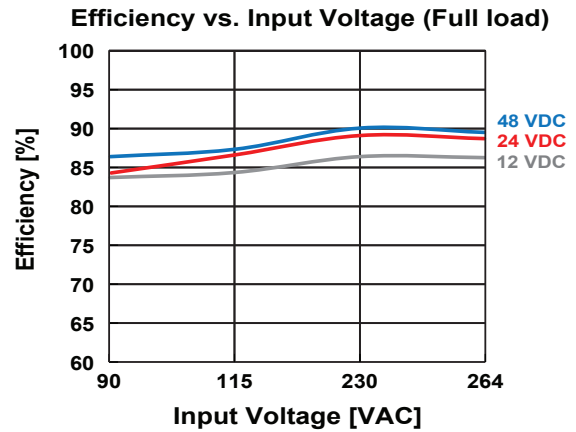
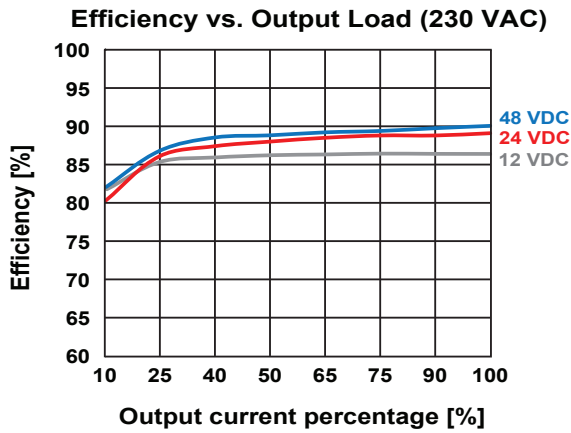

SPDE241201

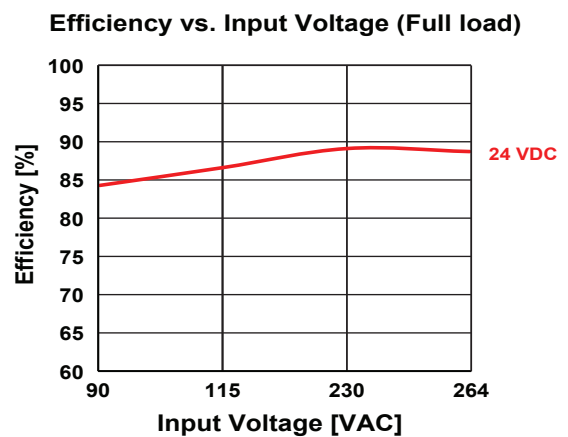
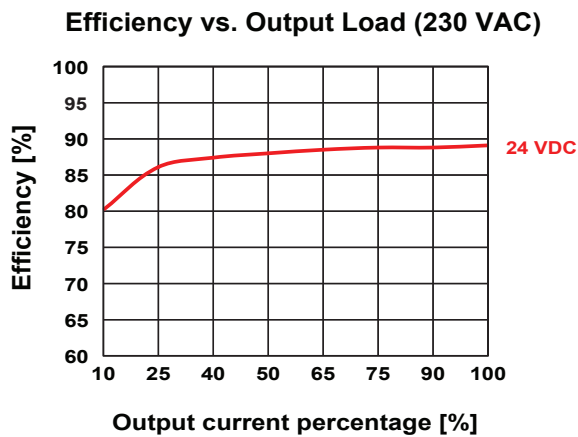

SPDE..120

Efficiency vs. Output Load (230 VAC)

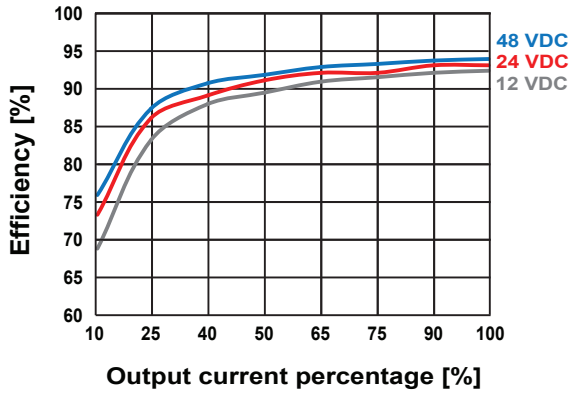

Efficiency vs. Input Voltage (Full load)

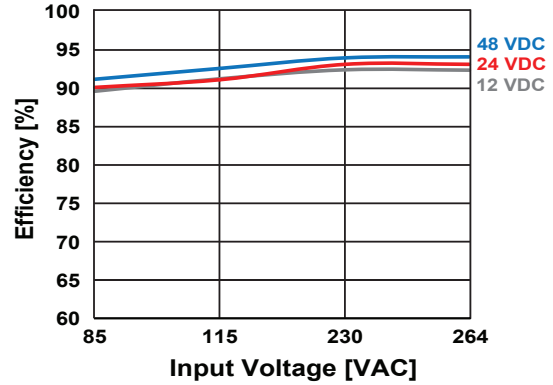

SPDE..190

Efficiency vs. Output Load (230 VAC)

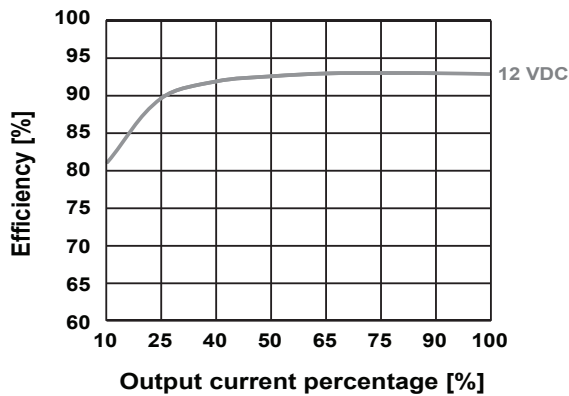

Efficiency vs. Input Voltage (Full load)

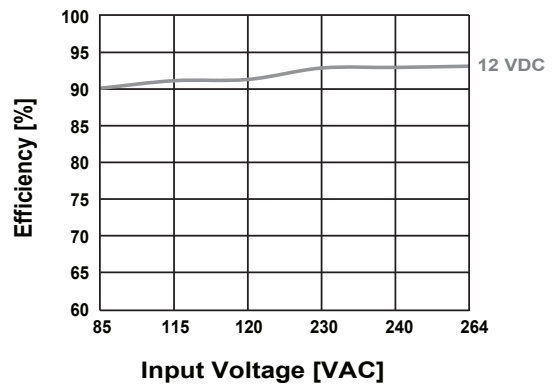

SPDE242401

Efficiency vs. Output Load (230 VAC)

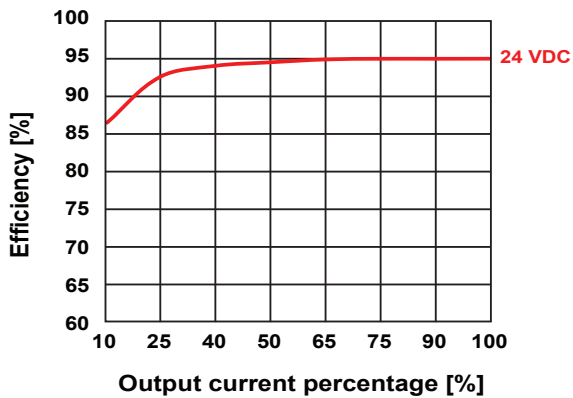

Efficiency vs. Input Voltage (Full load)

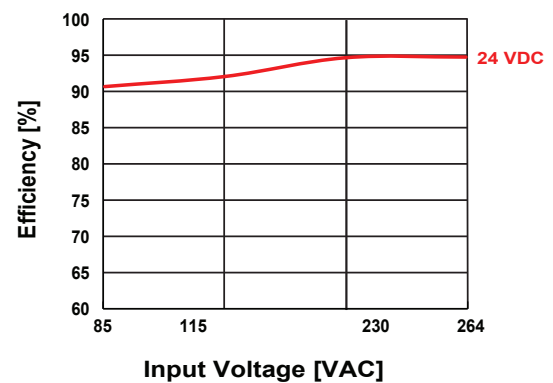

SPDE..240

Efficiency vs. Output Load (230 VAC)

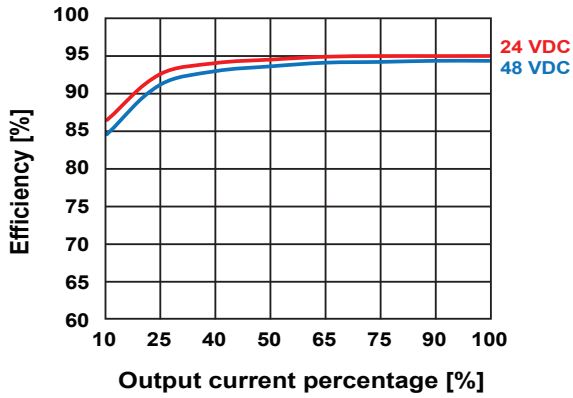

Efficiency vs. Input Voltage (Full load)

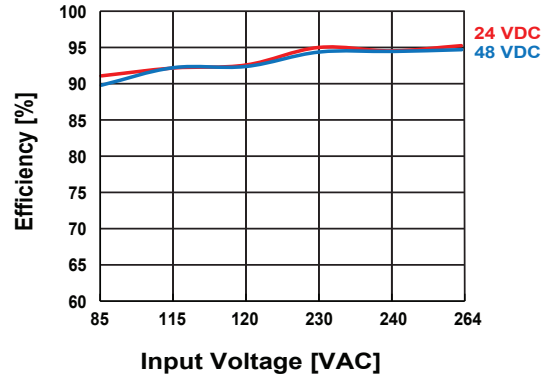

SPDE..480

Efficiency vs. Output Load (230 VAC)

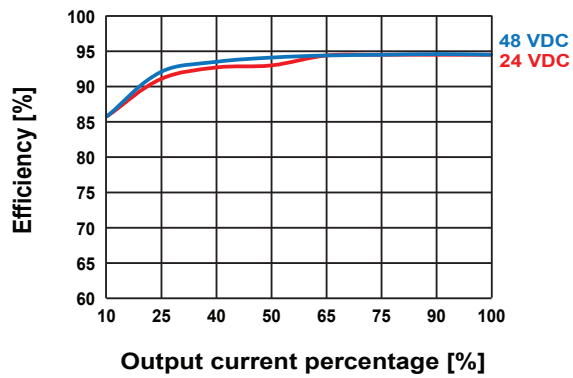

Efficiency vs. Input Voltage (Full load)

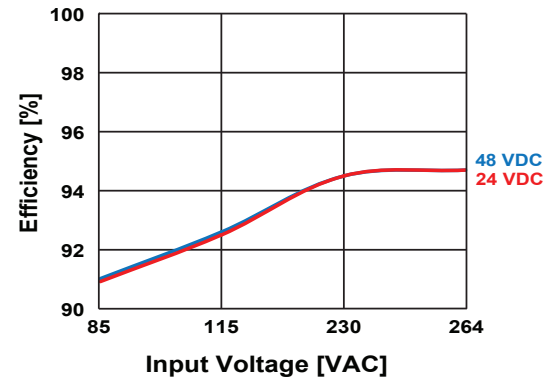

Wiring diagram

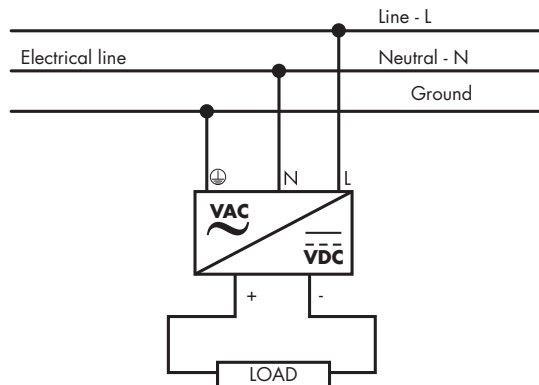

Connection specification

		SPDE..75	SPDE..120	SPDE..190	SPDE..240	SPDE..480
Terminal type		Screw terminals with Phillips screw head				
Screw driver blade		3.5 mm slotted or Phillips				
Tightening torque (recommended)		0.4 Nm		0.79 Nm		0.5 Nm
Conductor cross section (input terminals)		0.14 - 6 mm ² (26 - 10 AWG)	0.14 - 6 mm ² (26 - 10 AWG)	0.14 - 6 mm ² (26 - 10 AWG)		0.5 - 6 mm ² (20 - 10 AWG)
Conductor cross section (PE connection)				4 - 6 mm ² (12 - 10 AWG)		
Conductor cross section (output terminals)	12 VDC	0.14 - 6 mm ² (26 - 10 AWG)	1.5 - 6 mm ² (16 - 10 AWG)	4 - 6 mm ² (12 - 10 AWG)	-	
	24 VDC		0.5 - 6 mm ² (20 - 10 AWG)	-	1.5 - 6 mm ² (16 - 10 AWG)	2.5 - 6 mm ² (14 - 10 AWG)
	48 VDC		0.34 - 6 mm ² (22 - 10 AWG)	-	1.0 - 6 mm ² (18 - 10 AWG)	
DC OK relay output*		-	0.25 - 1.5 mm ² (24 - 16 AWG)			

* applies to SPDE..R models only

Note: for SPDE241201 Conductor cross section (output terminals): 1.5 - 6 mm² (16 - 10 AWG)

Block diagram

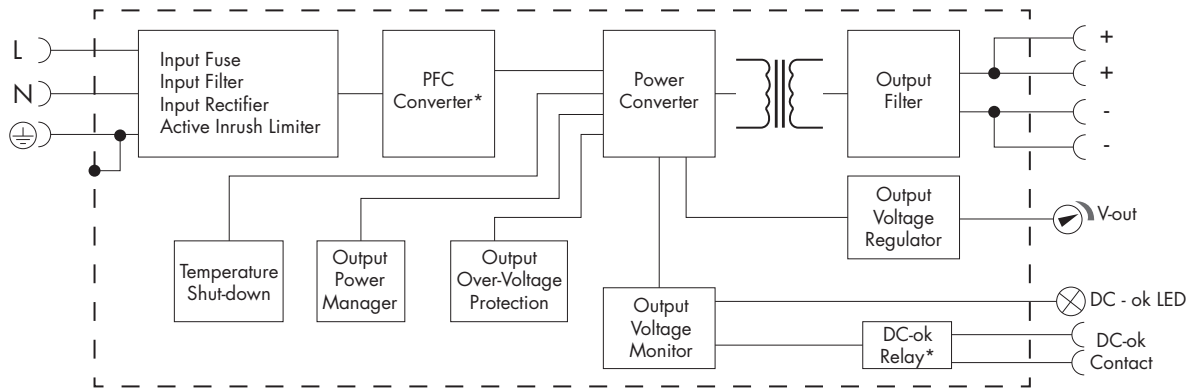

* only in SPDE..R versions

Operating description

Control and protection

		SPDE..75	SPDE..120	SPDE..190	SPDE..240	SPDE..480
Oversvoltage protection						
	12 VDC	≤ 17 V	≤ 16 V	≤ 18 V		
	24 VDC	≤ 33 V	≤ 33 V		≤ 35 V	29 - 35 V
	48 VDC	≤ 60 V	≤ 60 V		≤ 60 V	56 - 60 V
Over-current protection	100% ~ 150% of rated current	Constant current mode, automatic recover after fault condition is removed		Self-recovery		The output turned off after working normally for 1 s, self-recovery
	>150% of rated current					Automatic recover after fault condition is removed
Current limiting		< 2 A	< 2.7 A (115 VAC)* < 1.6 A (230 VAC)* < 1.5 A	< 4 A		< 5.5 A
Short circuit protection		Constant current, continuous, self-recovery				Hiccup, continuous, self-recovery
Over temperature protection		Output voltage turn off, re-power on for recover after the temp. drops.	Output voltage turn off, re-power on for recover.	80°C		60°C to 90°C
Reverse voltage protection		No				

* applies to SPDE241201 only