

1SNK910303R0000 ✓ ACTIVE

ENTRELEC | ENTRELEC SNK

TE Internal #: 1SNK910303R0000

Terminal Block & Strip Conducting Accessories, Jumper Bar, 3 Pole, Orange, Product Spacing .394 in [10 mm], -67 – 230 °F [-55 – 110 °C], ENTRELEC SNK

[View on TE.com >](#)



Connectors > Terminal Blocks & Strips > Terminal Block & Strip Accessories > Terminal Block & Strip Conducting Accessories

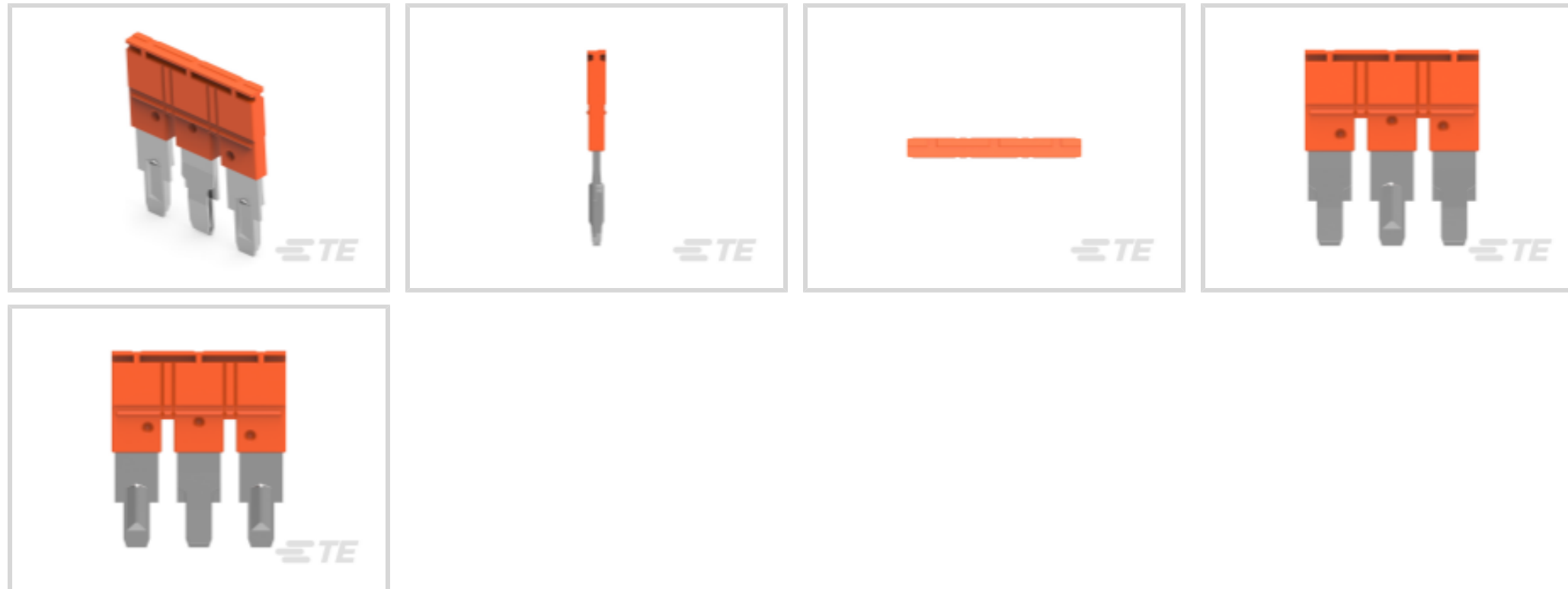

Conducting Accessory Type: **Jumper Bar**

Number of Poles: **3**

PCB Mount Retention Type: **Screwless**

Primary Product Color: **Orange**

Product Spacing: **10 mm [.394 in]**

Features

Product Type Features

Conducting Accessory Type	Jumper Bar
---------------------------	------------

Configuration Features

Number of Poles	3
-----------------	---

Electrical Characteristics

Operating Voltage Rating (UL & CSA) (Max) - Main Circuit	600 V
Impulse Withstanding Voltage Rating (IEC)	6000 V
Voltage Rating (CSA)	600 V
Current Rating (CSA)	67 A
Short-Time Withstanding Current Rating @ 1s	1920 A
Power Loss	2.4 W
Dielectric Withstanding Voltage (Max)	2200 V
Voltage Rating (IEC)	1000 V
Current Rating (UL)	67 A
Current Rating (IEC)	76 A



Body Features

Plastic & Resin Material Type	Polyamide
Product Weight	7.1 g [.25 oz]
Primary Product Color	Orange

Contact Features

Contact Current Rating (Max)	76 A
------------------------------	------

Mechanical Attachment

PCB Mount Retention Type	Screwless
--------------------------	-----------

Dimensions

Product Depth	31.5 mm [1.24 in]
Product Width	10 mm [.394 in]
Product Height	28 mm [1.102 in]
Product Spacing	10 mm [.394 in]

Usage Conditions

Installation Temperature Range	-5 – 40 °C [23 – 104 °F]
Operating Temperature Range	-55 – 110 °C [-67 – 230 °F]

Industry Standards

IP Rating	IP20
-----------	------

Product Compliance







[For compliance documentation, visit the product page on TE.com>](#)

EU RoHS Directive 2011/65/EU	Compliant
EU ELV Directive 2000/53/EC	Compliant
China RoHS 2 Directive MIIT Order No 32, 2016	No Restricted Materials Above Threshold
EU REACH Regulation (EC) No. 1907/2006	Current ECHA Candidate List: JAN 2023 (233) Candidate List Declared Against: JAN 2023 (233) Does not contain REACH SVHC
Halogen Content	Low Halogen - Br, Cl, F, I < 900 ppm per homogenous material. Also BFR/CFR/PVC Free
Solder Process Capability	Not reviewed for solder process capability

Product Compliance Disclaimer

This information is provided based on reasonable inquiry of our suppliers and represents our current actual knowledge based on the information they provided. This information is subject to change. The part numbers that TE has identified as EU RoHS compliant have a maximum concentration of 0.1% by weight in homogenous materials for lead, hexavalent chromium, mercury, PBB, PBDE, DBP, BBP, DEHP, DIBP, and 0.01% for cadmium, or qualify for an exemption to these limits as defined in the Annexes of Directive 2011/65/EU (RoHS2). Finished electrical and electronic equipment products will be CE marked as required by Directive 2011/65/EU. Components may not be CE marked. Additionally, the part numbers that TE has identified as EU ELV compliant have a maximum concentration of 0.1% by weight in homogenous materials for lead, hexavalent chromium, and mercury, and 0.01% for cadmium, or qualify for an exemption to these limits as defined in the Annexes of Directive 2000/53/EC (ELV). Regarding the REACH Regulation, the information TE provides on SVHC in articles for this part number is based on the latest European Chemicals Agency (ECHA) 'Guidance on requirements for substances in articles' posted at this URL: <https://echa.europa.eu/guidance-documents/guidance-on-reach>

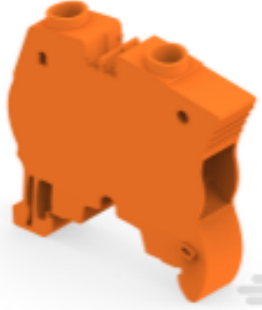
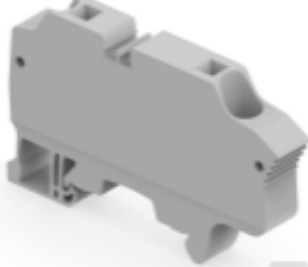
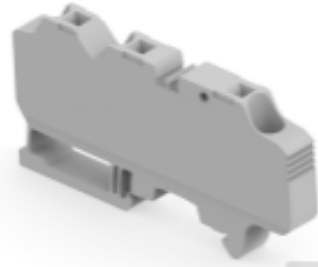
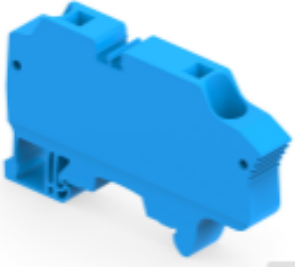
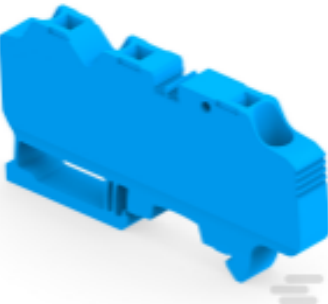
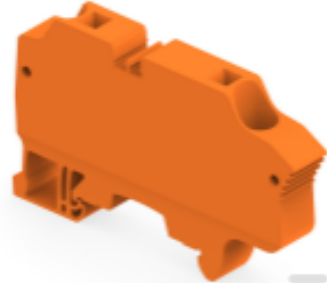
Compatible Parts

 <p>TE Part # 1SNK510010R0000 ZS16</p>	 <p>TE Part # 1SNK710151R0000 ZK10-PE-3P</p>	 <p>TE Part # 1SNK900101R0000 CS</p>	 <p>TE Part # 1SNK510020R0000 ZS16-BL</p>
 <p>TE Part # 1SNK510030R0000 ZS16-OR</p>	 <p>TE Part # 1SNK710010R0000 ZK10</p>	 <p>TE Part # 1SNK710011R0000 ZK10-3P</p>	 <p>TE Part # 1SNK710020R0000 ZK10-BL</p>
 <p>TE Part # 1SNK710021R0000 ZK10-3P-BL</p>	 <p>TE Part # 1SNK710030R0000 ZK10-OR</p>	 <p>TE Part # 1SNK710150R0000 ZK10-PE</p>	 <p>TE Part # 1SNK900659R0000 TO3.5-50-A</p>

Also in the Series | **ENTRELEC SNK**



Modular Terminal Blocks(320)



Terminal Block & Strip Conducting Accessories(67)

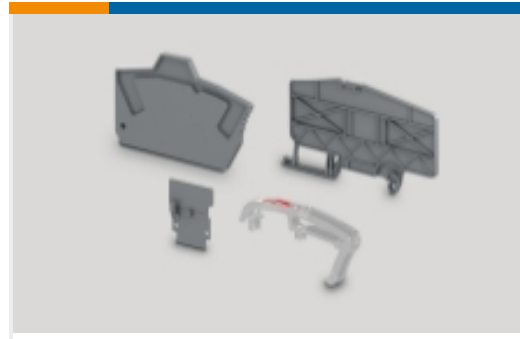

Terminal Block & Strip Insulating Accessories(31)

Customers Also Bought



TE Part #1SNK705911R0000
EK2.5-3P



TE Part #1SNK706410R0000
ZK2.5-SF



TE Part #1SNK708020R0000
ZK6-BL



TE Part #1SNK710010R0000
ZK10



TE Part #1SNK712150R0000
ZK16-PE



TE Part #1SNK910310R0000
JB10-10



TE Part #1SNA399617R0200
D35/16.2L



TE Part #1SNA399620R1100
D35/16.P.2L



TE Part #1SNA399621R0600
BJD16-2



TE Part #1SNA360120R1000
DISPOSABLE PLOTTER PEN 0.25

Documents

CAD Files

[3D PDF](#)

[3D](#)

Customer View Model

[ENG_CVM_CVM_1SNK910303R0000_A.2d_dxf.zip](#)

English

Customer View Model

[ENG_CVM_CVM_1SNK910303R0000_A.3d_igs.zip](#)



English

Customer View Model

[ENG_CVM_CVM_1SNK910303R0000_A.3d_stp.zip](#)

English

By downloading the CAD file I accept and agree to the [Terms and Conditions](#) of use.

Datasheets & Catalog Pages

[ENTRELEC Terminal Block - Master Catalog](#)

[ENTRELEC Terminal Block - Master Catalog](#)

English

JB10-3

English

SNK SERIES TERMINAL BLOCKS

English

[ENTRELEC Terminal Blocks Catalogue \(RUS\)](#)

Essential Entrelec Terminal Blocks

French

Essential Entrelec Terminal Blocks

English

Essential Entrelec Terminal Blocks

Japanese