

Data sheet | Item number: 770-245

Socket; 5-pole; Cod. B; 4,00 mm²; gray

www.wago.com/770-245

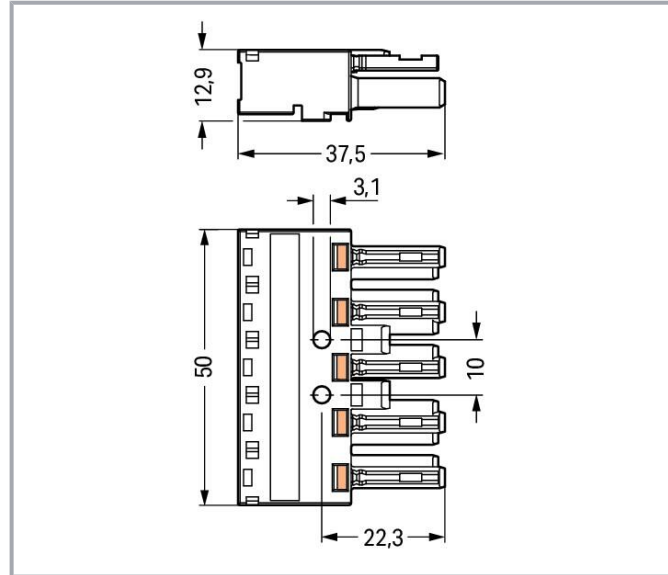

Item description

Female connector/socket WINSTA® MIDI with protection type IP20

For power and signal transmission: The WINSTA® MIDI female connector/socket with protection against mismatching. WAGO pluggable installation connectors are useful when specifications repeat or are planned on a specified pattern, for example for installing grid lighting or flush-mount lighting. For greater protection in electrical installations, the pluggable installation connector is equipped with mechanical protection against mismatching. The pluggable installation connector offers protection against contact with live components in accordance with protection type IP20 (When mated and secured with a strain relief housing: IP2xC (These compact connectors are not designed for use in open, easily accessible areas!)). B coding enables the WINSTA® MIDI pluggable installation connectors to be used for control in applications in the domains of automation, mechanical engineering and robotics. This pluggable installation connector can be used for electrical currents up to 25 A. Thus the product is ideally suitable for high power loads. The WINSTA® MIDI Pluggable Connection System with Push-in CAGE CLAMP® spring pressure connection technology facilitates exemplary electrification. Due to the built-in test slot, it is possible to check connections even when they are plugged in. That saves time and reduces installation labor and costs.

Subject to changes. Please also observe the further product documentation!

WAGO GmbH & Co. KG
Hansastr. 27
32423 Minden
Phone: +49571 887-0 | Fax: +49571 887-169
Email: info.de@wago.com | Web: www.wago.com

Do you have any questions about our products?
We are always happy to take your call at +49 (571) 887-44222.



Push-in CAGE CLAMP® spring pressure connection technology – pluggable installation instead of laborious screw connections!

The WINSTA® Pluggable Connection System is perfectly tailored to the strict requirements of building installation. It makes electrical installation pluggable, and thus faster, more reliable, and error-free. Use of this pre-assembled system decreases assembly times and installation errors at the construction site. Choose durability and quality – the WINSTA® MIDI pluggable installation connector with marking from WAGO makes the installation of electrical components visibly easier.

- effective protection against mismatching
- simple circuits
- for automation controllers
- exact dimensions
- fast, secure installation

Data

Notes

Variants:

Other pole markings

Other versions (or variants) can be requested from WAGO Sales or configured at <https://configurator.wago.com/>.

Electrical data

Ratings per IEC/EN

Ratings per	IEC/EN 60664-1
Nominal voltage (III/3)	400 V
Rated impulse voltage (III/3)	6 kV
Rated current	25 A
Note (rated current)	25 A for 3-pole load 20 A for 4- and 5-pole load
Legend (ratings)	(III / 3) ≙ Overvoltage category III / Pollution degree 3

Ratings per UL 1977

Note for the US market

Some versions may also be used for current interruption in accordance with the UL certificate in select applications with currents below 16 A and voltages up to 600 V. For further information, please contact your local sales office.

Subject to changes. Please also observe the further product documentation!

WAGO GmbH & Co. KG

Hansastr. 27

32423 Minden

Phone: +49571 887-0 | Fax: +49571 887-169

Email: info.de@wago.com | Web: www.wago.com

Do you have any questions about our products?

We are always happy to take your call at +49 (571) 887-44222.



Rated voltage (UL 1977)	600 V
Rated current UL 1977	23 A

General

Note on contact resistance	approx. 1 mΩ of contact resistance approx. 0.25 mΩ contact transition plug/socket
----------------------------	--

Connection data

Connection points	10
Total number of potentials	5

Connection 1

Connection technology	Push-in CAGE CLAMP®
Actuation type	Operating tool Push-in
Nominal cross-section	4 mm ² / 12 AWG
Solid conductor	0.5 ... 4 mm ² / 20 ... 12 AWG
Solid conductor; push-in termination	1.5 ... 4 mm ² / 16 ... 12 AWG
Stranded conductor	0.5 ... 2.5 mm ² / 20 ... 14 AWG
Fine-stranded conductor	0.5 ... 4 mm ² / 20 ... 12 AWG
Fine-stranded conductor; with insulated ferrule	0.25 ... 1.5 mm ² / 20 ... 16 AWG
Fine-stranded conductor; with uninsulated ferrule	0.25 ... 2.5 mm ² / 20 ... 14 AWG
Fine-stranded conductor; with ferrule; push-in termination	1.5 mm ² / 16 AWG
Strip length	9 mm / 0.35 inches
Pole number	5
Conductor entry direction to mating direction	0°

Physical data

Pin spacing	10 mm / 0.394 inches
Width	50 mm / 1.969 inches
Height	12.9 mm / 0.508 inches
Depth	37.5 mm / 1.476 inches

Mechanical Data

Application	Control technology
Coding	B

Subject to changes. Please also observe the further product documentation!

WAGO GmbH & Co. KG
Hansastr. 27
32423 Minden
Phone: +49571 887-0 | Fax: +49571 887-169
Email: info.de@wago.com | Web: www.wago.com

Do you have any questions about our products?
We are always happy to take your call at +49 (571) 887-44222.



Variable coding	Yes
Marking	1 2 3 4 5
Potential marking	1 2 3 4 5
Mating force of a plug-in connection	approx. 20 ... 70 N (depending on pole number)
Retention force of a plug-in connection	Locked: > 80 N
Unmating force of a plug-in connection	Unlocked: approx. 20 ... 70 N (depending on pole number)
Number of mating cycles	200, without resistive load
Protection type	IP20; When mated and secured with a strain relief housing: IP2xC (These compact connectors are not designed for use in open, easily accessible areas!)

Plug-in connection

Contact type (pluggable connector)	Female connector/socket
Connector (connection type)	for conductor
Mismating protection	Yes
Note on mismating protection	All WINSTA [®] components are 100% protected against mismating when: a.) plugging different numbers of poles b.) plugging while rotated 180 c.) plugging while laterally staggered d.) plugging one pole
Locking lever	Can be retrofitted
Locking of plug-in connection	locking lever
Note on locking system	All connectors for mounted installations (snap-in versions for lighting fixtures or devices, all types of PCB and distribution connectors) are factory-equipped with locking levers to ensure plugs and sockets are securely locked. Additional locking levers are only required for flying leads (plug/socket).

Material Data

Note (material data)	Information on material specifications can be found here
Color	gray
Cover color	gray
Material group	I
Insulation material	Polyamide (PA66)
Flammability class per UL94	V0
Clamping spring material	Chrome-nickel spring steel (CrNi)
Contact material	Copper or copper alloy; surface-treated

Subject to changes. Please also observe the further product documentation!

Contact plating	Tin
Fire load	0.407 MJ
Weight	16.1 g

Environmental requirements

Processing temperature	-5 ... +40 °C
Continuous operating temperature	-35 ... +85 °C
Note on continuous operating temperature	Insulating parts for temperatures ≤ 105 °C

Commercial data



Product Group	20 (Winsta)
eCl@ss 10.0	27-44-06-05
eCl@ss 9.0	27-44-06-05
ETIM 8.0	EC002560
ETIM 7.0	EC002560
PU (SPU)	50 pcs
Packaging type	box
Country of origin	DE
GTIN	4044918252454
Customs tariff number	85366990990

Environmental Product Compliance

RoHS Compliance Status	Compliant, No Exemption
------------------------	-------------------------



Approvals / Certificates

General approvals



Logo	Approval	Additional Approval Text	Certificate name
	CCA DEKRA Certification B.V.	IEC 61984	NL-32104
	CCA DEKRA Certification B.V.	EN 61984	2173495.01
	cURus Underwriters Laboratories Inc.	UL 1977	E45171

Subject to changes. Please also observe the further product documentation!





Declarations of conformity and manufacturer's declarations

Logo	Approval	Additional Approval Text	Certificate name
	EU-Declaration of Conformity WAGO GmbH & Co. KG	-	-
	UK-Declaration of Conformity WAGO GmbH & Co. KG	-	-

Approvals for marine applications

Logo	Approval	Additional Approval Text	Certificate name
	ABS American Bureau of Shipping	-	19- HG1868589- PDA
	DNV GL Det Norske Veritas, Germanischer Lloyd	-	TAE00001Z6
	LR Lloyds Register	IEC 61984	LR22429487TA

Counterpart

	Item no.770-1641 T-distribution connector; 5-pole; Cod. B; 1 input; 2 outputs; 2 locking levers; gray	www.wago.com/770-1641
	Item no.770-1741 T-distribution connector; 5-pole; Cod. B; 1 input; 2 outputs; 3 locking levers; for flying leads; gray	www.wago.com/770-1741
	Item no.770-255 Plug; 5-pole; Cod. B; 4,00 mm ² ; gray	www.wago.com/770-255
	Item no.770-1744 3-way distribution connector; 5-pole; Cod. B; 1 input; 3 outputs; gray	www.wago.com/770-1744

Subject to changes. Please also observe the further product documentation!



Item no. 770-755
Snap-in plug; 5-pole; Cod. B; 4,00 mm²; gray

www.wago.com/770-755



Item no. 770-855
Plug for PCBs; straight; 5-pole; Cod. B; gray

www.wago.com/770-855



Item no. 770-855/011-000
Plug for PCBs; angled; 5-pole; Cod. B; gray

www.wago.com/770-855/011-000



Item no. 771-9995/005-103
pre-assembled interconnecting cable; Eca; Socket/plug; 5-pole; Cod. B; 1 m; 1,00 mm²; gray

www.wago.com/771-9995/005-103



Item no. 771-9995/205-103
pre-assembled connecting cable; Eca; Plug/open-ended; 5-pole; Cod. B; 1 m; 1,00 mm²; gray

www.wago.com/771-9995/205-103

Required accessories

Locking levers

Locking system



Item no.: 770-121
Locking lever; for flying leads; for manual operation; white

www.wago.com/770-121



Item no.: 770-131
Locking lever; for flying leads; for tool operation; white

www.wago.com/770-131



Item no.: 770-101
Locking lever; for flying leads; for manual operation; black

www.wago.com/770-101



Item no.: 770-111
Locking lever; for flying leads; for tool operation; black

www.wago.com/770-111

Strain relief

Strain relief housing



Item no.: 770-505/021-000
Strain relief housing; 5-pole; for 1 cable; 11.5 ... 16.5 mm; 71 mm; black

www.wago.com/770-505/021-000



Item no.: 770-505/023-000
Strain relief housing; 5-pole; for 2 cables; 5.0 ... 9.0 mm; 55 mm; black

www.wago.com/770-505/023-000



Item no.: 770-505
Strain relief housing; 5-pole; for 2 cables; 9.0 ... 13.0 mm; 55 mm; black

www.wago.com/770-505

Subject to changes. Please also observe the further product documentation!



Item no.: 770-515

Strain relief housing; 5-pole; for 2 cables; 9.0 ... 13.0 mm; 55 mm; white

www.wago.com/770-515



Item no.: 770-515/023-000

Strain relief housing; 5-pole; for 2 cables; 5.0 ... 9.0 mm; 55 mm; white

www.wago.com/770-515/023-000



Item no.: 770-515/021-000

Strain relief housing; 5-pole; for 1 cable; 11.5 ... 16.5 mm; 71 mm; white

www.wago.com/770-515/021-000

Optional accessories

Tool

Operating tool



Item no.: 210-719

Operating tool; Blade: 2.5 x 0.4 mm; with a partially insulated shaft

www.wago.com/210-719

Cover

Cover



Item no.: 770-201

Lockout cap; 12-pole, separable; for sockets; Plastic; black

www.wago.com/770-201



Item no.: 770-221

Lockout cap; 12-pole, separable; for sockets; Plastic; white

www.wago.com/770-221



Item no.: 897-2005

Protective cap; Type4; for sockets and plugs; PVC; red

www.wago.com/897-2005

Marking accessories

Marker



Item no.: 770-450/000-002

Marker card; Plastic; yellow

www.wago.com/770-450/000-002



Item no.: 770-450/000-001

Marker card; Plastic; green

www.wago.com/770-450/000-001

Subject to changes. Please also observe the further product documentation!

WAGO GmbH & Co. KG

Hansastr. 27

32423 Minden

Phone: +49571 887-0 | Fax: +49571 887-169

Email: info.de@wago.com | Web: www.wago.com

Do you have any questions about our products?

We are always happy to take your call at +49 (571) 887-44222.



Item no.: 770-450/000-005
Marker card; Plastic; red

www.wago.com/770-450/000-005



Item no.: 770-450
Marker card; Plastic; white

www.wago.com/770-450



Item no.: 770-450/000-006
Marker card; Plastic; blue

www.wago.com/770-450/000-006



Item no.: 770-450/000-012
Marker card; Plastic; orange

www.wago.com/770-450/000-012

Mounting

Snap-in frame



Item no.: 770-320
Snap-in frame; 5-pole; 1.0 ... 3.0 mm; black

www.wago.com/770-320



Item no.: 770-321
Snap-in frame; 5-pole; 0.5 ... 2.0 mm; black

www.wago.com/770-321



Item no.: 770-340
Snap-in frame; 5-pole; 1.0 ... 3.0 mm; white

www.wago.com/770-340



Item no.: 770-341
Snap-in frame; 5-pole; 0.5 ... 2.0 mm; white

www.wago.com/770-341

Downloads

Documentation

Bid Text

Item no.	Date	File type	Size	Action
770-245	2019 Feb 19	xml	3.0 kB	Download
X81 - Datei				
770-245	2015 Jun 8	doc		Download

Subject to changes. Please also observe the further product documentation!



doc - Datei

24.6 kB

CAD/CAE-Data

CAD data

2D/3D Models 770-245	URL	Download
----------------------	---------------------	--------------------------

CAE data

EPLAN Data Portal 770-245	URL	Download
---------------------------	---------------------	--------------------------

WSCAD Universe 770-245	URL	Download
------------------------	---------------------	--------------------------

ZUKEN Portal 770-245	URL	Download
----------------------	---------------------	--------------------------

Environmental Product Compliance

Compliance Search

Environmental Product Compliance 770-245 Socket; 5-pole; Cod. B; 4,00 mm ² ; gray	URL	Download
---	---------------------	--------------------------

Installation Notes

Conductor termination

Subject to changes. Please also observe the further product documentation!

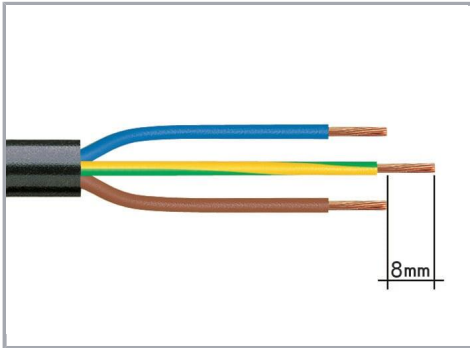

1. Strip length, outer insulation = 35 mm (2-pole), 55 mm (3- to 5-pole)
2. Strip length = 9 mm
3. Extended ground conductor = 8 mm

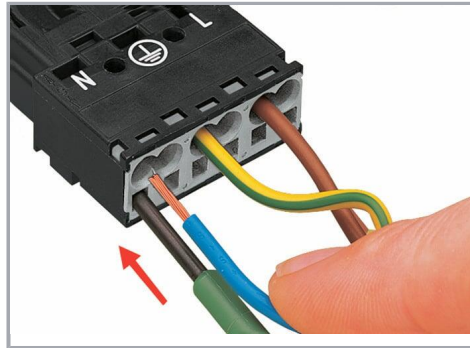

To terminate fine-stranded conductors, open the clamping unit via screwdriver (2.5 mm blade width) and insert a stripped conductor until it hits the backstop.

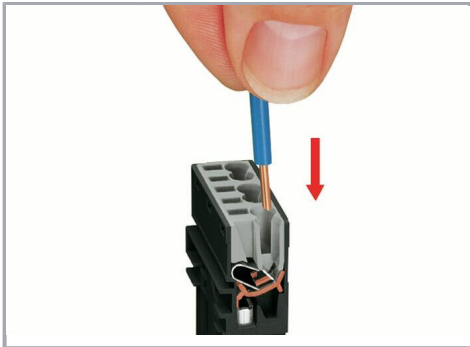

Insert the stripped solid conductor until it hits the backstop.

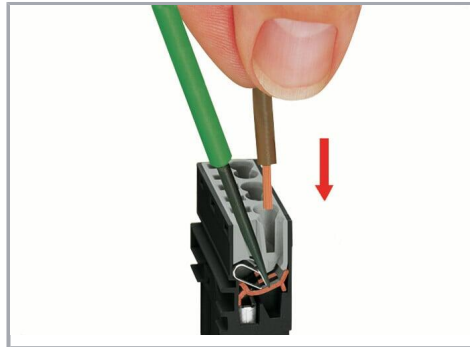

To terminate fine-stranded conductors, open the clamping unit via screwdriver (2.5 mm blade width) and insert a stripped conductor until it hits the backstop.

Conductor removal

Subject to changes. Please also observe the further product documentation!

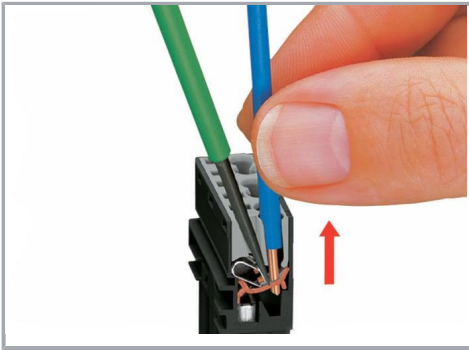

To remove the conductor, actuate the clamp via screwdriver (2.5 mm blade width) and pull out the conductor.

Installation

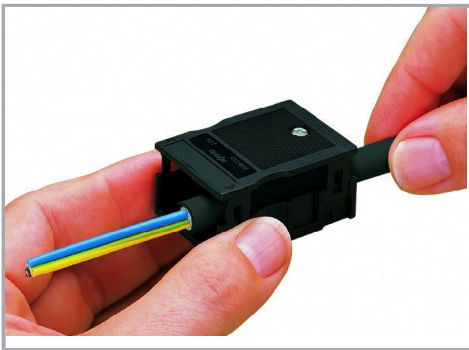

We recommend pulling the pre-latched strain relief housing over the cable prior to termination. However, the strain relief can be mounted at a later time as well.

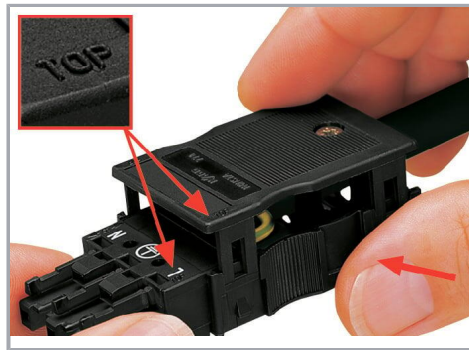

Latch the strain relief housing onto the plug /socket. Note the "TOP" inscription.

Subject to changes. Please also observe the further product documentation!

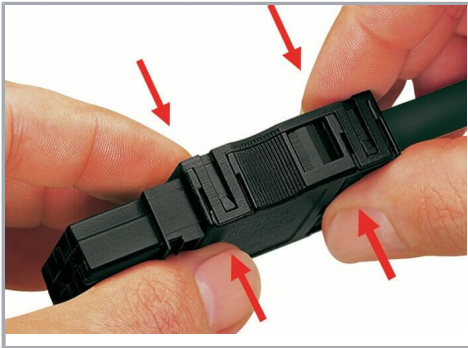

Prepare strain relief housing by snapping together upper and bottom part.



Tighten strain relief screw with screwdriver (2.5 mm blade width).

Coding



Simply cut off the coding pin from the socket.

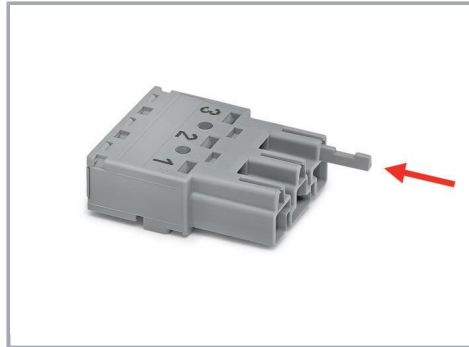

Insert coding pin into plug (break first) until it engages.

Mismatching protection

Subject to changes. Please also observe the further product documentation!

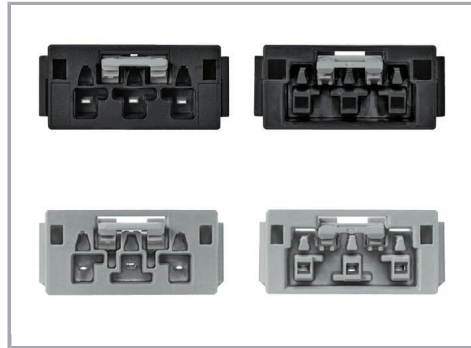
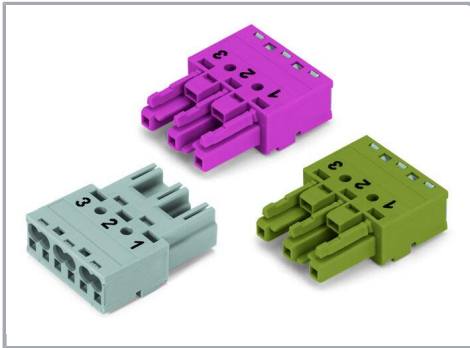

B-coded connectors with different colors can be plugged together.

Important note:

Different colors and/or pole markings are used for circuit identification.

Only connectors of the same color and same pole marking must be plugged together.

B-coded connectors (shown in gray) not only differ in color, but also in their design, making them incompatible with other coded connectors.



Easy circuit identification via different marking and colors

Product family

WINSTA® MIDI

[Show all products from the family](#)

Subject to changes. Please also observe the further product documentation!