

225 Watts

- Low 1.18" Profile U Channel Construction
- -40 °C to +70 °C Operation
- 3.12" by 5.0" Footprint
- 150 W Convection/ 225 W Forced Cooled Ratings
- Optional 5 V Standby and Remote On/Off
- 12 V Fan Output
- Medical and ITE Approvals
- High Efficiency, up to 95%
- Less than 0.5 W No Load Input Power



The UCP225 series is designed to minimize the no load power consumption and maximize efficiency to facilitate equipment design to meet the latest environmental legislation. Approved for medical and ITE applications, this range of single output AC/DC power supplies are packaged in an ultra-low profile 1.18" height with a foot print of just 3.12" by 5.0". The UCP225 provides up to 225 W force-cooled or 150 W convection-cooled leading to very high power densities of 12.2 W/in³ or 8.1 W/in³ respectively. A 12 V, 500 mA fan supply is included in the design which can also be delivered with an optional 5 V/2 A standby output. The power supply contains two fuses and low leakage currents as required by medical applications and is safety approved to operate in a 70 °C ambient. The low profile and safety approvals covering ITE and medical standards along with conducted emissions to EN55011/22 level B allow the versatile UCP225 series to be used in a vast range of applications.

Dimensions:

UCP225:
5.00 x 3.12 x 1.18" (127.0 x 79.2 x 29.2 mm)

Models & Ratings

Output Voltage	Output Current		Optional Standby Output		Fan Output ^(7,8)	Efficiency ⁽²⁾	Model Number ^(3,4,5,6)
	Convection-cooled	Forced-cooled ⁽¹⁾	Convection-cooled	Forced-cooled ⁽¹⁾			
12.0 V	12.50 A	18.75 A	5 V/1.0 A	5 V/2.0 A	12 V/0.5 A	92%	UCP225PS12
15.0 V	10.00 A	15.00 A	5 V/1.0 A	5 V/2.0 A	12 V/0.5 A	92%	UCP225PS15
18.0 V	8.33 A	12.50 A	5 V/1.0 A	5 V/2.0 A	12 V/0.5 A	92%	UCP225PS18
24.0 V	6.25 A	9.38 A	5 V/1.0 A	5 V/2.0 A	12 V/0.5 A	92%	UCP225PS24
28.0 V	5.36 A	8.04 A	5 V/1.0 A	5 V/2.0 A	12 V/0.5 A	92%	UCP225PS28
36.0 V	4.16 A	6.25 A	5 V/1.0 A	5 V/2.0 A	12 V/0.5 A	92%	UCP225PS36
48.0 V	3.10 A	4.69 A	5 V/1.0 A	5 V/2.0 A	12 V/0.5 A	92%	UCP225PS48

Notes

1. Requires 10 CFM or optional top fan cover, -TF
2. Minimum average efficiencies measured at 25%, 50%, 75% & 100% of 225 W load and 230 VAC input
3. Add suffix -T for input and output screw terminals e.g. UCP225PS24-T
4. Add suffix -TF for fan cover version e.g. UCP225PS24-TF
5. Add suffix -C for vented cover version e.g. UCP225PS24-C
6. Add suffix -A for optional 5 V, 2 A standby and remote on/off e.g. UCP225PS24-A
7. Typical voltage, actual regulated voltage will be in range of 10.5 V to 11.1V
8. Regulation of the fan output requires a minimum load of 10W on the main output.

Input

Characteristic	Minimum	Typical	Maximum	Units	Notes & Conditions
Input Voltage - Operating	85	115/230	264	VAC	Derate output from 100% at 90 VAC to 90% at 85 VAC
Input Frequency	47	50/60	63	Hz	
Power Factor		>0.9			230 VAC, 100% load. EN61000-3-2 class A, class C >145W
Input Current - Full Load		2.2/1.1		A	115/230 VAC
Inrush Current		120		A	230 VAC cold start, 25 °C
Earth Leakage Current		80/140	230	µA	115/230 VAC/50 Hz (Typ), 264 VAC/60 Hz (Max)
No load Input Power			0.5	W	When main output is Inhibited
Input Protection	F3.15 A/250V Internal fuse fitted in line and neutral.				

Output - Main Output

Characteristic	Minimum	Typical	Maximum	Units	Notes & Conditions
Output Voltage - V1	12		48	VDC	See Models and Ratings table
Initial Set Accuracy			±1	%	50% load, 115/230 VAC
Minimum Load	0			A	No minimum load required
Start Up Delay			2	s	115/230 VAC full load.
Hold Up Time	10	20/13		ms	Min at full load, 115 VAC. Typical at 150W/ 225W
Drift			±0.02	%	After 20 min warm up
Line Regulation			±0.5	%	90-264 VAC
Load Regulation			±0.5	%	0-100% load.
Transient Response			4	%	Recovery within 1% in less than 500 µs for a 50-75% and 75-50% load step
Over/Undershoot		5	9	%	Full load
Ripple & Noise			1	% pk-pk	20 MHz bandwidth and 10 µF electrolytic capacitor in parallel with 0.1 µF ceramic capacitor.
Overvoltage Protection	110		140	%	Vnom, recycle input to reset
Overload Protection	110		175	% I nom	
Short Circuit Protection					Trip & Restart
Temperature Coefficient			0.02	%/°C	
Overtemperature Protection					Measured internally, Auto Resetting

Output - Optional 5 V Standby Output

Characteristic	Minimum	Typical	Maximum	Units	Notes & Conditions
Output Voltage		5.0		VDC	
Initial Set Accuracy			±1	%	50% load, 115/230 VAC
Minimum Load	0			A	
Start Up Delay			0.5	s	115/230 VAC full load.
Hold Up Time	300			ms	Min at full load, 115 VAC.
Drift			±0.02	%	After 20 min warm up
Line Regulation			±0.5	%	90-264 VAC
Load Regulation			±0.5	%	0-100% load.
Transient Response			4	%	Recovery within 1% in less than 500 µs for a 50-75% and 75-50% load step
Over/Undershoot			5	%	Full load
Ripple & Noise			1.2	% pk-pk	20 MHz bandwidth and 10 µF electrolytic capacitor in parallel with 0.1 µF ceramic capacitor
Overload Protection		2.4	4.0	A	
Short Circuit Protection					Trip & Restart
Temperature Coefficient			0.02	%/°C	
Remote On/Off	Connect pin 3 of CN2 to pin 1 to turn main output off. Connect to pin 2 or leave open to turn main output on.				

General

Characteristic	Minimum	Typical	Maximum	Units	Notes & Conditions
Efficiency		94		%	230 VAC Full load (see fig. 1 to 4)
Isolation: Input to Output Input to Ground Output to Ground	4000			VAC	2 MOPP
	1500			VAC	1 MOPP
	1500			VAC	1 MOPP
Switching Frequency	40		130	kHz	PFC
	50		80	kHz	Main converter
		65		kHz	For optional standby output
Power Density			12.2/8.1	W/in ³	Forced/convection-cooled
Mean Time Between Failure		300		kHrs	MIL-HDBK-217F, Notice 2 +25 °C GB
Weight		0.71 (320)		lb(g)	For U channel version

Efficiency Vs Load

Figure 1
UCP225PS12

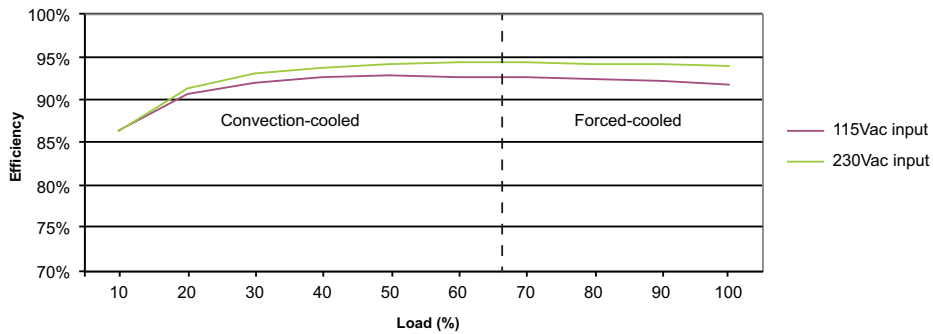
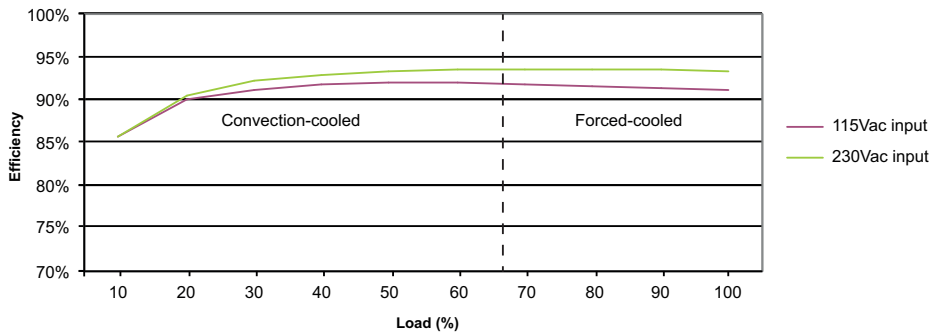

Figure 2
UCP225PS12-A



Efficiency Vs Load

Figure 3
UCP225PS24

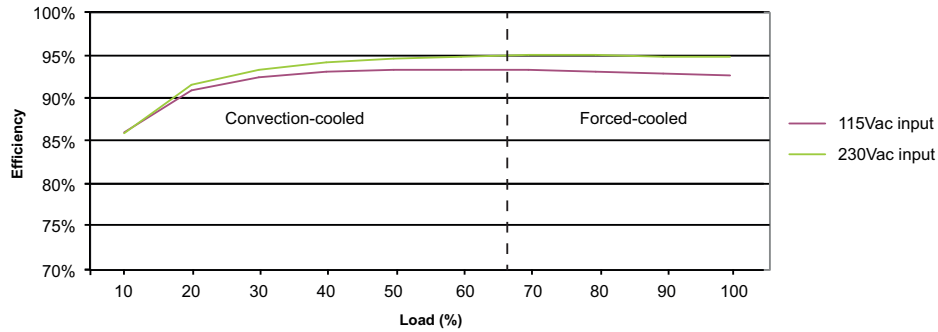
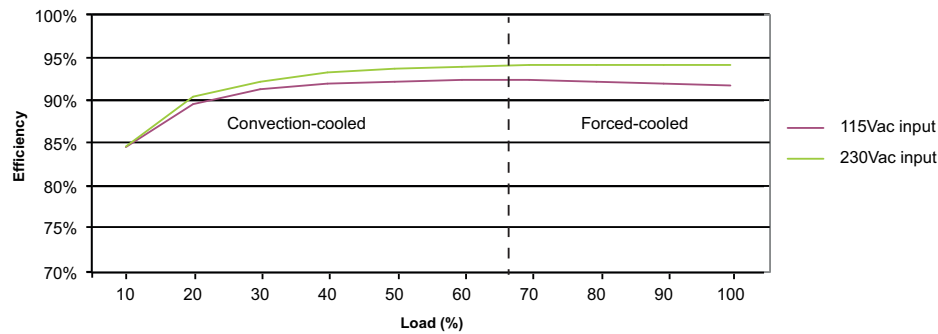

Figure 4
UCP225PS24-A



Environmental

Characteristic	Minimum	Typical	Maximum	Units	Notes & Conditions
Operating Temperature	-40		+70	°C	-40 °C for 150 W load, -25 °C for 225 W load, See derating curve, fig.5 and fig.6
Storage Temperature	-40		+85	°C	
Cooling	10			CFM	Forced-cooled > 150W
Humidity	5		95	%RH	Non-condensing
Operating Altitude			5000/4000	m	ITE/Medical
Shock	±3 x 30g shocks in each plane, total 18 shocks. 30g = 11ms (+/- 0.5msecs), half sine. Conforms to EN60068-2-27				
Vibration	Single axis 10-500 Hz at 2g sweep and endurance at resonance in all 3 planes. Conforms to EN60068-2-6				

Temperature Derating Curves

Figure 5 - 150 W Convection Cooled

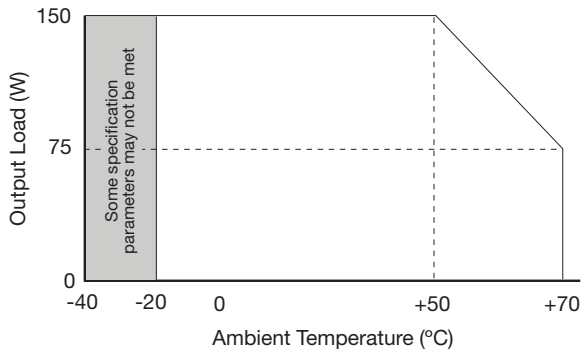
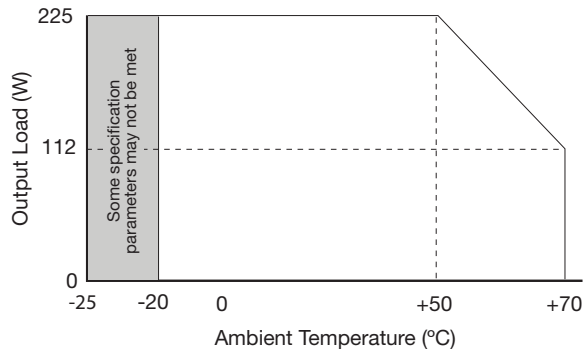

Figure 6 - 225 W Forced Cooled



EMC: Emissions

Phenomenon	Standard	Test Level	Criteria	Notes & Conditions
Conducted	EN55011/32	Class B		
Radiated	EN55011/32	Class A		Class B with King Core ferrites Output cable: KCF-130-B Input cable for 150W load: K5B RC 14x28.5x7-M for all models with additional KCF-130-B on 48V version. Input cable for 225W load: K5B RC 14x28.5x7-M plus KCF-130-B.
Harmonic Current	EN61000-3-2	Class A		Meet Class C for loads above 145W
Voltage Functions	EN61000-3-3			

EMC: Immunity

Phenomenon	Standard	Test Level	Criteria	Notes & Conditions
Medical Device EMC	IEC60601-1-2	Ed.4.0 : 2014	as below	
Low Voltage PSU EMC	EN61204-3	High severity level	as below	
ESD	EN61000-4-2	4	A	±8kV contact, ±15kV air
Radiated	EN61000-4-3	3	A	
EFT	EN61000-4-4	3	A	
Surges	EN61000-4-5	Installation class 3	A	
Conducted	EN61000-4-6	3	A	
Magnetic Fields	EN61000-4-8	4	A	
Dips and Interruptions	EN55024 (100 VAC)	Dip >95% (0 VAC), 8.3 ms	A	
		Dip 30% (70 VAC), 416 ms	A	
		Dip >95% (0 VAC), 4160 ms	B	
	EN55024 (240 VAC)	Dip >95% (0 VAC), 10.0 ms	A	
		Dip 30% (168 VAC), 500 ms	A	
		Dip >95% (0 VAC), 5000 ms	B	
	EN60601-1-2 (100 VAC)	Dip 100% (0 VAC), 10.0 ms	A	
		Dip 100% (0 VAC), 20 ms	B	Performance criteria A <60 W for 15 V & 18 V versions, <100 W for others
		Dip 60% (40 VAC), 100 ms	A	Derate Output Power to 40 W
		Dip 30% (40 VAC), 500 ms	A	
		Dip 100% (0 VAC), 5000 ms	B	
	EN60601-1-2 (240 VAC)	Dip 100% (0 VAC), 10.0 ms	A	
		Dip 100% (0 VAC), 20 ms	B	Performance criteria A <60 W for 15 V & 18 V versions, <100 W for others
		Dip 60% (96 VAC), 100 ms	A	
Dip 30% (168 VAC), 500 ms		A		
Dip 100% (0 VAC), 5000 ms		B		

Safety Approvals

Safety Agency	Safety Standard	Notes & Conditions
CB Report	IEC60950-1	Information Technology
UL	UL60950-1, CSA 22.2 No.60950-1-11	Information Technology
TUV	EN60950-1	Information Technology
CE	LVD	

Safety Agency	Safety Standard	Notes & Conditions
CB Report	IEC60601-1 Ed 3.1 Including Risk Management	Medical
UL	ANSI/AAMI ES60601-1 & CSA C22.2 No.60601-1:08	Medical
TUV	EN60601-1	Medical

Isolation	Level	Notes & Conditions
Primary to Secondary	2 x MOPP (Means of Patient Protection)	IEC60601-1 Ed 3.1
Primary to Earth	1 x MOPP (Means of Patient Protection)	
Secondary to Earth	1 x MOPP (Means of Patient Protection) @ 48 VDC	

Mechanical Details

Standard U-Channel Version

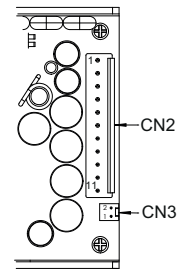
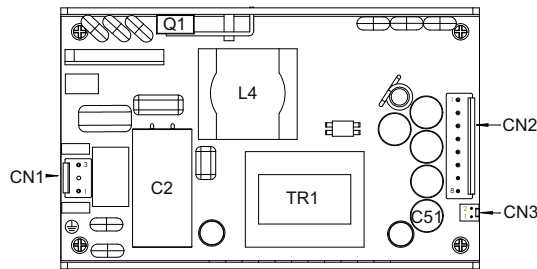
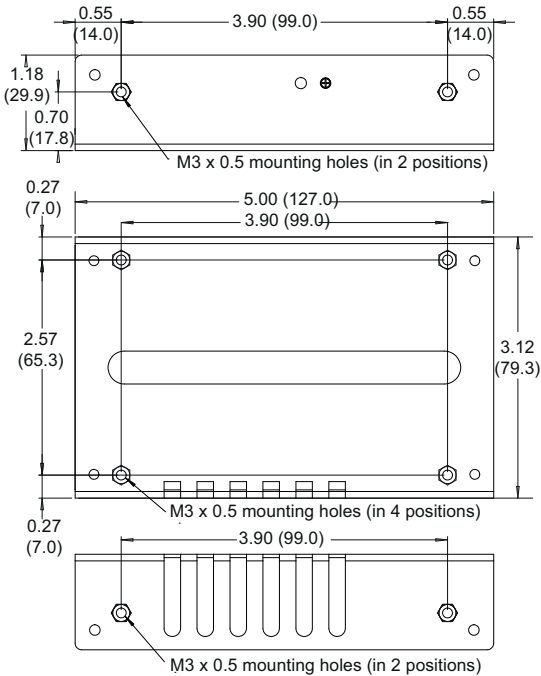

Optional Standby Output & Remote On/Off Version, -A

CN1 - Input Connector	
Pin 1	Neutral
Pin 2	Not Fitted
Pin 3	Line

Mates with JST housing
VHR-3N and JST Series
SVH-21T-P1.1 crimp terminals

CN3 - Fan Connector	
Pin 1	Fan -
Pin 2	Fan +

Mates with Molex housing
22-01-1022 and 2759 crimp terminals

CN2 - Output Connector for standard models	
Pin 1	+Vout
Pin 2	+Vout
Pin 3	+Vout
Pin 4	+Vout
Pin 5	-Vout
Pin 6	-Vout
Pin 7	-Vout
Pin 8	-Vout

Mates with JST housing
VHR-8N and JST Series
SVH-21T-P1.1 crimp terminals

CN2 - Output Connector for optional -A version	
Pin 1	+5 V Standby
Pin 2	RTN
Pin 3	Remote On/Off
Pin 4	+Vout
Pin 5	+Vout
Pin 6	+Vout
Pin 7	+Vout
Pin 8	-Vout
Pin 9	-Vout
Pin 10	-Vout
Pin 11	-Vout

Mates with JST housing
VHR-11N and JST Series
SVH-21T-P1.1 crimp terminals

Notes

- All dimensions shown in inches (mm).
Tolerance: ± 0.02 (0.5)
- Weight: 0.71 lbs (320 g) approx.

- A kit is available containing the housings and crimps for CN1, CN2 and CN3 for the -A version with optional standby, order part ECP_UCP-A CON KIT

Mechanical Details

Covered Version (-C suffix)

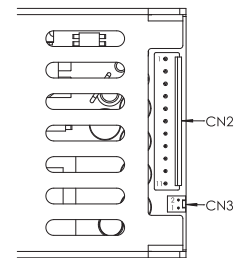
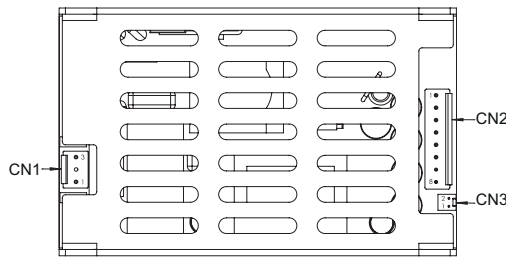
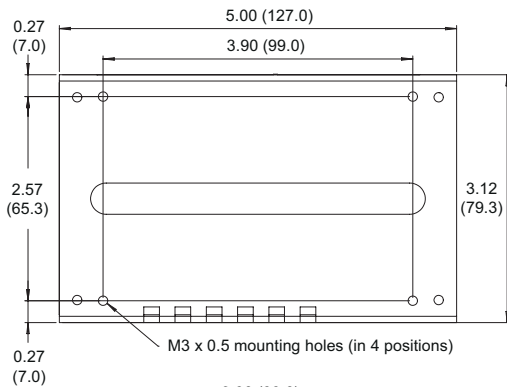
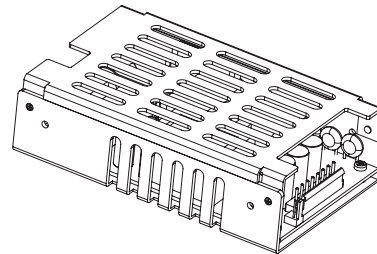
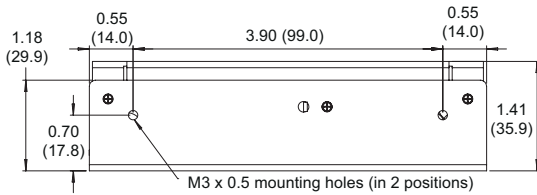

Optional Standby Output & Remote On/Off Version, -A-C

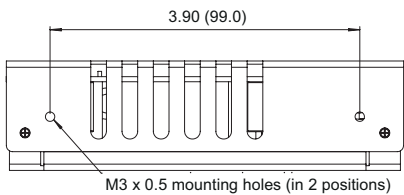

CN1 - Input Connector	
Pin 1	Neutral
Pin 2	Not Fitted
Pin 3	Line

Mates with JST housing
VHR-3N and JST Series
SVH-21T-P1.1 crimp terminals

CN3 - Fan Connector	
Pin 1	Fan -
Pin 2	Fan +

Mates with Molex housing
22-01-1022 and 2759 crimp terminals

CN2 - Output Connector for standard models	
Pin 1	+Vout
Pin 2	+Vout
Pin 3	+Vout
Pin 4	+Vout
Pin 5	-Vout
Pin 6	-Vout
Pin 7	-Vout
Pin 8	-Vout

Mates with JST housing
VHR-8N and JST Series
SVH-21T-P1.1 crimp terminals

CN2 - Output Connector for optional -A version	
Pin 1	+5 V Standby
Pin 2	RTN
Pin 3	Remote On/Off
Pin 4	+Vout
Pin 5	+Vout
Pin 6	+Vout
Pin 7	+Vout
Pin 8	-Vout
Pin 9	-Vout
Pin 10	-Vout
Pin 11	-Vout

Mates with JST housing
VHR-11N and JST Series
SVH-21T-P1.1 crimp terminals

Notes

- All dimensions shown in inches (mm).
Tolerance: ± 0.02 (0.5)
- Weight: 0.78 lbs (355 g) approx.

- A kit is available containing the housings and crimps for CN1, CN2 and CN3 for the -A version with optional standby, order part ECP225_UCP225-A CON KIT.

Mechanical Details

Top Fan Version (-TF suffix)

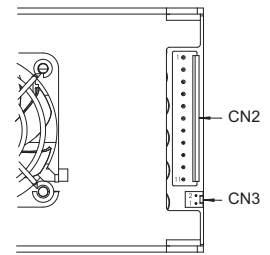
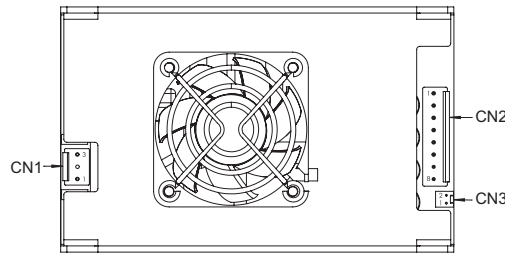
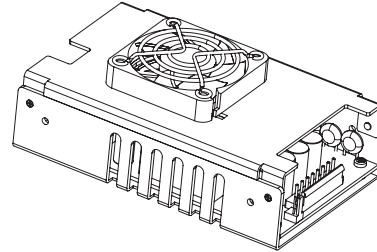
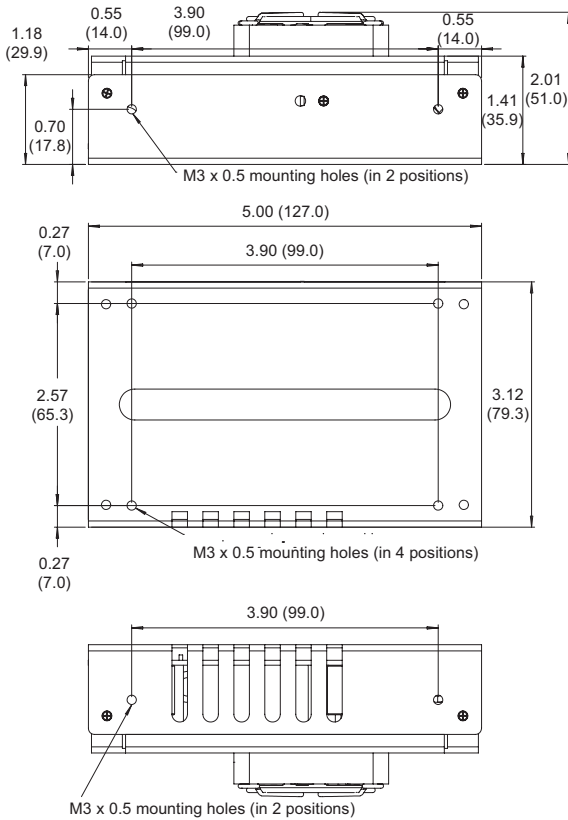

Optional Standby Output & Remote On/Off Version, -A-TF

CN1 - Input Connector	
Pin 1	Neutral
Pin 2	Not Fitted
Pin 3	Line

Mates with JST housing
VHR-3N and JST Series
SVH-21T-P1.1 crimp terminals

CN3 - Fan Connector	
Pin 1	Fan -
Pin 2	Fan +

Mates with Molex housing
22-01-1022 and 2759 crimp terminals

CN2 - Output Connector for standard models	
Pin 1	+Vout
Pin 2	+Vout
Pin 3	+Vout
Pin 4	+Vout
Pin 5	-Vout
Pin 6	-Vout
Pin 7	-Vout
Pin 8	-Vout

Mates with JST housing
VHR-8N and JST Series
SVH-21T-P1.1 crimp terminals

CN2 - Output Connector for optional -A version	
Pin 1	+5 V Standby
Pin 2	RTN
Pin 3	Remote On/Off
Pin 4	+Vout
Pin 5	+Vout
Pin 6	+Vout
Pin 7	+Vout
Pin 8	-Vout
Pin 9	-Vout
Pin 10	-Vout
Pin 11	-Vout

Mates with JST housing
VHR-11N and JST Series
SVH-21T-P1.1 crimp terminals

Notes

- All dimensions shown in inches (mm).
Tolerance: ± 0.02 (0.5)
- Weight: 0.86 lbs (390 g) approx.

- A kit is available containing the housings and crimps for CN1, CN2 and CN3 for the -A version with optional standby, order part ECP225_UCP225-A CON KIT.

Thermal Considerations

In order to ensure safe operation of the PSU in the end-use equipment, the temperature of the components listed in the table below must not be exceeded. Temperature should be monitored using K type thermocouples placed on the hottest part of the component (out of direct air flow). See Mechanical Details for component locations.

Temperature Measurements (At Maximum Ambient)	
Component	Max Temperature °C
TR1 Coil	110°C
L4 Coil	120°C
Q1 Body	120°C
C2	105°C
C51	105°C

Service Life

The estimated service life of the UCP225 is determined by the cooling arrangements and load conditions experienced in the end application. Due to the uncertain nature of the end application this estimated service life is based on the actual measured temperature of a key capacitor with in the product when installed by the end application,

The graph below expresses the estimated lifetime of a given component temperature and assumes continuous operation at this temperature.

Estimated Service Life vs Component Temperature

Figure 5

