Sup/IRBuck™

USER GUIDE FOR IR38064 EVALUATION BOARD

DESCRIPTION

The IR38064 is a synchronous buck converter with a PMBus interface, providing a compact, high performance and flexible solution in a small 5mmx7mm PQFN package.

Key features offered by the IR38064 include I2C/PMBus configurability of output voltage, soft-start, input UVLO, input overvoltage protection, output overvoltage protection, output overcurrent protection, Power Good, thermal protection and switching frequency. Additionally, the IR38064 also features enhanced line/ load regulation with feed forward, external frequency synchronization with smooth clocking, internal LDO, true differential remote sensing and pre-bias start-up.

A temperature and bias compensated output over-current protection function is implemented by sensing the voltage developed across the on-resistance of the synchronous rectifier MOSFET for optimum cost and performance.

This user guide contains the schematic and bill of materials for the IR38064 evaluation board. The guide describes operation and use of the evaluation board itself. Detailed application information for IR38064 is available in the IR38064 data sheet.

BOARD FEATURES

- $P_{Vin} = +12V (+ 13.2V \text{ Max})$, **No Vcc required.**
- $V_{out} = +1.2V @ 0-35A$
- $F_s = 600kHz$
- $L = 0.150\mu H$
- $C_{in} = 4 \times 22\mu F$ (ceramic 1206) + $1 \times 330\mu F$ (electrolytic, optional)
- $C_{out} = 10 \times 47\mu F$ (ceramic 0805)

CONNECTIONS and OPERATING INSTRUCTIONS

A well regulated +12V input supply should be connected to PVin+ and PVin-. A maximum of 35A load should be connected to VOUT+ and VOUT-. The inputs and output connections of the board are listed in Table I.

IR38064 needs only one input supply and internal LDO generates Vcc from PVin. Another internal LDO generates the 1.8V needed by the internal digital circuits. If operation with external Vcc is required, then R25 should be removed and external Vcc can be applied between Vcc+ and Vcc- pins. Vin pin and Vcc pins should be shorted together for external Vcc operation by installing R24. For tracking operation R27 should be populated with a 0 ohm resistor. **For normal, non-tracking operation, R27 should not be populated and a 100 kOhm resistor should be connected from the Track_En pin to P1V8 .**

The board is configured for remote sensing. If local sense is desired, R8 should be uninstalled and R16 should be installed instead.

I2C/PMBus communication is established through the 4 pin header which allows connection to the SCL/SDA/SALERT and GND lines from the host/dongle. For proper operation in digital communications mode, R35 must always be populated.

External Enable signal can be applied to the board via exposed Enable pad and *R18 should be removed for this purpose.*

Table I. Connections

Connection	Signal Name
PVin+	PVin (+12V)
PVin-	Ground of PVin
Vout+	Vout(+1.2V)
Vout-	Ground for Vout
Vcc+	Vcc Pin
Vcc-	Ground for Vcc input
Enable	Enable
PGood	Power Good Signal

LAYOUT

The PCB is a 6-layer board. All of layers are 2 Oz. copper. The IR38064 and most of the passive components are mounted on the top side of the board. Power supply decoupling capacitors and feedback components are located close to IR38064. The feedback resistors are connected to the output of the remote sense amplifier of the IR38064 and are located close to the IR38064. To improve efficiency, the circuit board is designed to minimize the length of the on-board power ground current path. Separate power ground and analog ground are used and may be connected together using a 0 ohm resistor.

CONNECTION DIAGRAM

PVin Vout

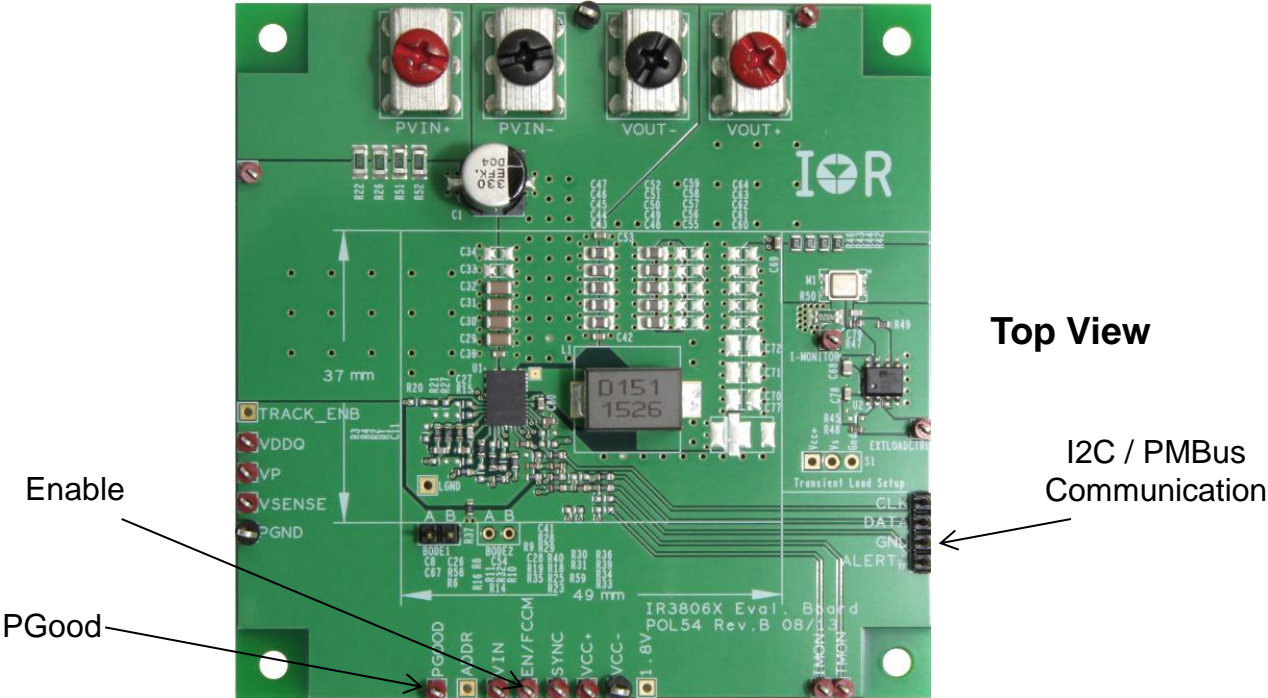

Top View

I2C / PMBus
Communication

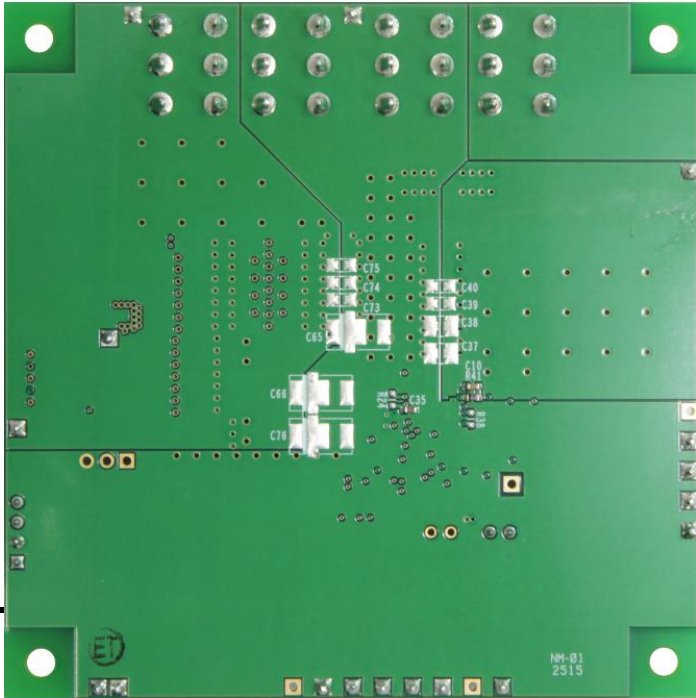

Bottom View

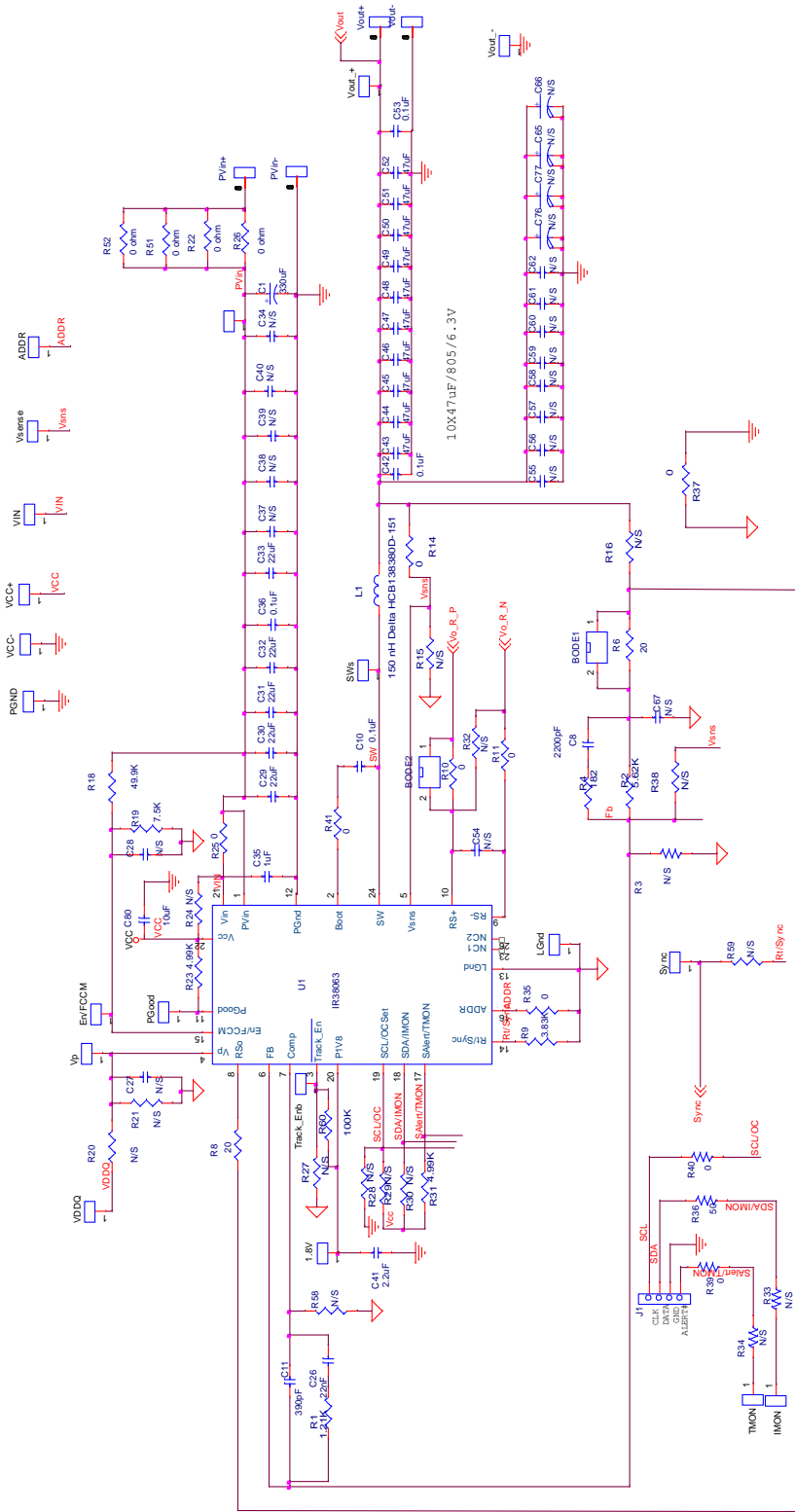

R60 is not present in evaluation boards older than Revision C

Single point of connection between Power Ground and Signal ("analog") Ground

Fig. 1: Schematic of the IR38064 evaluation board

R29 and R30 are unpopulated because our USB/12C converter module has on-board pullups.

Schematic for Transient Load set up

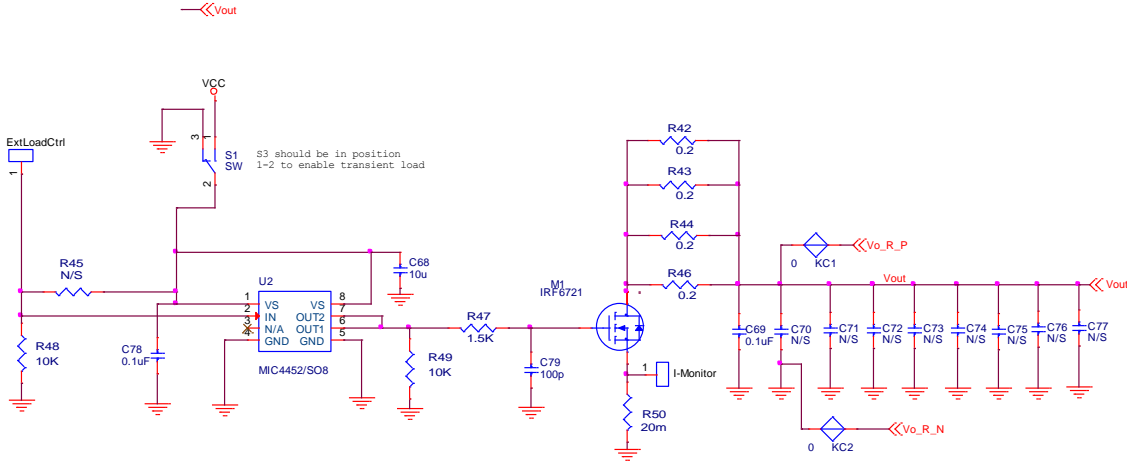

Bill of Materials

Item Number	Quantity	Part Reference	Value	Description	Manufacturer	Part Number
1	1	C1	330uF	SMD Electrolytic, F size, 25V, 20%	Panasonic	EEE-FK1E331P
2	1	C8	2200pF	2200pF, 0603, 50V, NPO	TDK	C1608C0G1H222J
3	1	C79	100 pF	50V, 0603, NP0, 5%	Murata	GRM1885C1H101JA01D
4	1	C11	390 pF	50V, 0603, NP0, 5%	Murata	GRM1885C1H391JA01D
5	1	C26	22nF	0603,50V,X7R	Murata	GRM188R71H223KA01D
6	4	C29 C30 C31 C32	22uF	22uF,1206, 25V, X5R, 20%	TDK	C3216X5R1E226M160AB
7	6	C10 C36 C42 C53 C69 C78	0.1uF	0603, 50V, X7R, 10%	Panasonic	ECJ-1VB1H104K
8	1	C35	1uF	0603, X5R, 25V, 20%	TDK	C1608X5R1E105M
9	10	C43 C44 C45 C46 C47 C48 C49 C50 C51 C52	47uF	0805, 6.3V, X5R, 20%	TDK	C2012X5R0J476M125AC
10	18	EXTLOADCTRL EN/FCCM I-MONITOR IMON PGND PGOOD SW SYNC TMON VCC+ VCC- VDDQ VIN VIN_+ VOUT_+ VOUT_- VP VSENSE	0.075" SQ_SMT_Te stPoint		Keystone Electronics	5000 and 5006
11	1	J1 (CLK, Data,GND, Alert)	Header-4P			4x1
12	1	Bode1	Header-2P			2x1
13	1	C41	2.2uF	0603, 10V, X5R	TDK	C1608X5R1A225M080AC
14	1	C68	10uF	0805, 10V, X5R	TDK	C2012X5R1A106M125AB
15	1	C80	10uF	0603, 10V, X5R, 20%	Murata	GRM188R61A106ME69D
16	1	R19	7.5k	0603,1/10W,1%	Rohm	MCR03EZPFX7501
17	1	L1	150nH	0.150uH, DCR=0.15mohm	Delta	HCB138380D-151
18	1	M1	IRF6721	Direct Fet 30V SQ	International Rectifier	IRF6721STRPbF
19	1	R1	1.21k	0603,1/10W,1%	Rohm	MCR03EZPFX1211
20	1	R2	5.62k	0603,1/10W,1%	Rohm	MCR03EZPFX5621
21	1	R9	66.5k	0603,1/10W,1%	Rohm	MCR03EZPFX6652
22	1	R4	182	0603,1/10W,1%	Rohm	MCR03EZPFX1820
23	1	R6	20	0603,1/10W,1%	Rohm	CRCW060320R0FKEA
24	11	R8 R10 R11 R14 R25 R35 R36 R37 R39 R40 R41	0 ohm	0603,1/10W	Rohm	CRCW06030000Z0EA
25	1	R18	49.9k	0603,1/10W,1%	Rohm	MCR03EZPFX4992
26	4	R22 R26 R51 R52	0 ohm	1206,1/4 W	Panasonic	ERJ-8GEY0R00V
27	4	R42 R43 R44 R46	0.2 ohm	0805,1/8W, 5%	CTS	73L3R20J
28	1	R47	1.5k	0603,1/10W,1%	Rohm	MCR03EZPFX1501
29	2	R48 R49	10k	0603,1/10W,1%	Rohm	MCR03EZPFX1002
30	1	R50	20 mohm	1206,1/2W,1%	Ohmite	LVK12R020FER
31	2	R23 R31	4.99k	0603,1/10W,1%	Rohm	MCR03EZPFX4991
32	1	U2	MIC4452/SO8	Mosfet driver Non-inverting SO-8	Micrel	MIC4452YM
33	1	U1	IR38064	IR38064 5mm X 7mm	International Rectifier	IR38064
34	2	Pvin+, Vout+ Connector	Red	Screw Terminal 30A	Keystone Electronics	8199-2
35	2	Pvin-, Vout- Connector	Black	Screw Terminal 30A	Keystone Electronics	8199-3

•The electrolytic input capacitor used on this demo board is to eliminate the impact of the parasitic inductance of a long input power cable. It may not be necessarily needed in real applications.

TYPICAL OPERATING WAVEFORMS

P_{Vin}=12.0V, V_{out}=1.2V, I_{out}=0A-35A, F_s=600kHz, Room Temperature, no airflow

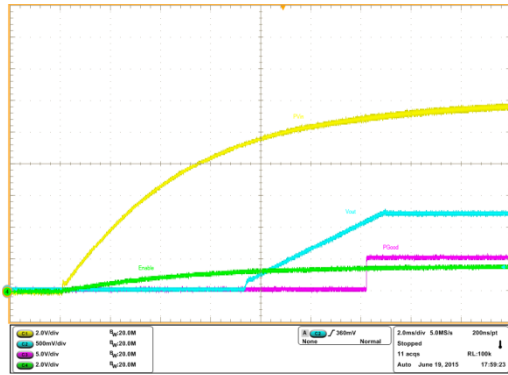

Fig. 2: P_{Vin} Start up at 35A Load
Ch₁:P_{Vin}, Ch₂:V_{out}, Ch₃:P_{Good}, Ch₄:Enable

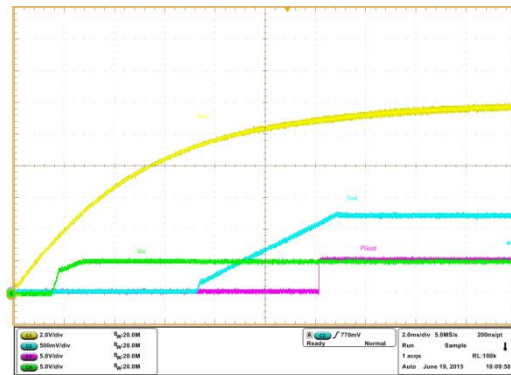

Fig. 3: P_{Vin} Start up at 35A Load
Ch₁:P_{Vin}, Ch₂:V_{out}, Ch₃:P_{Good}, Ch₄:V_{cc}

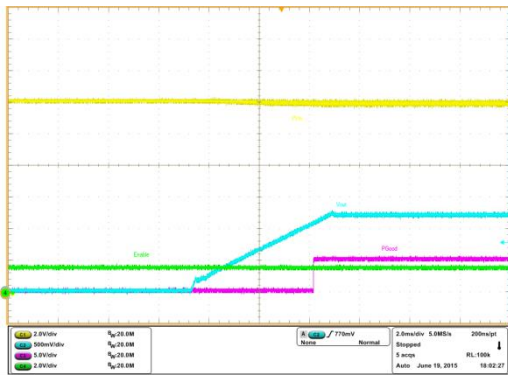

Fig. 4: Operation 80, Turn ON without margining, 35A load
Ch₁:P_{Vin}, Ch₂:V_{out}, Ch₃:P_{Good}, Ch₄:Enable

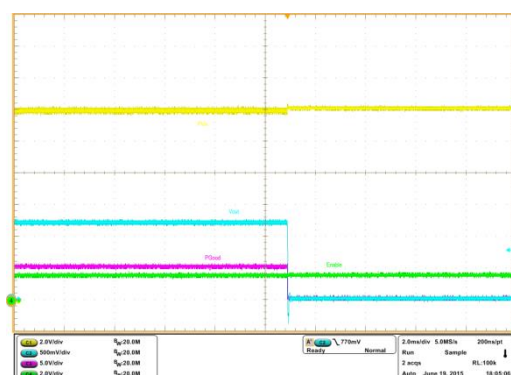

Fig. 5: Operation 00, Immediate OFF, 35A load
Ch₁:P_{Vin}, Ch₂:V_{out}, Ch₃:P_{Good}, Ch₄:Enable

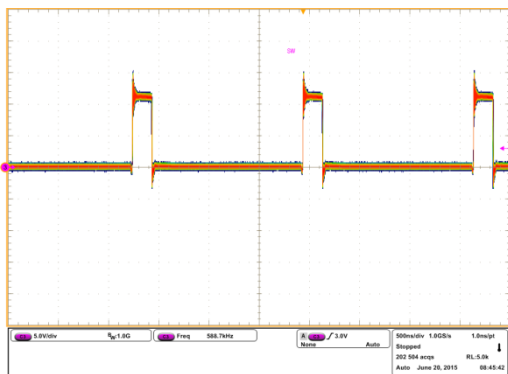

Fig. 6: Inductor node at 35A load
Ch₃:SW node

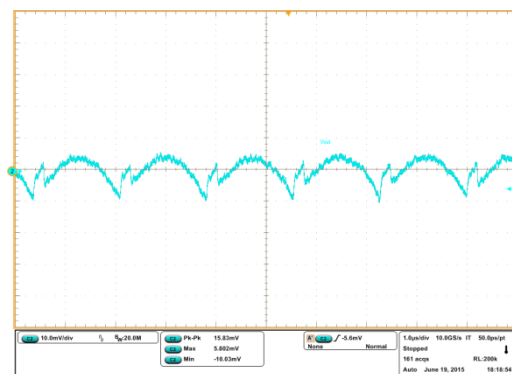

Fig. 7: Output voltage ripple at 35A load
Ch₂:V_{out}

TYPICAL OPERATING WAVEFORMS

PVin=12.0V, Vout=1.2V, Iout=0A-35A, Fs=600kHz, Room Temperature, no airflow

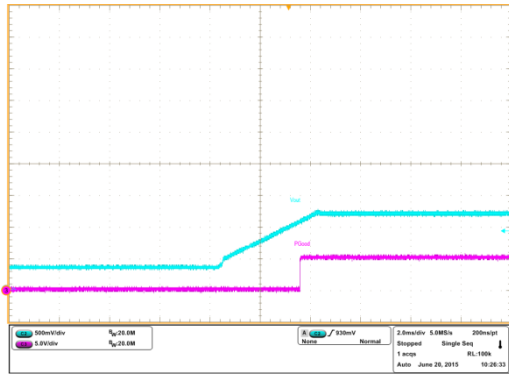

Fig. 8: 0.35V Prebias voltage startup at 0A load
 Ch2:V_{out}, Ch3:P_{Good}

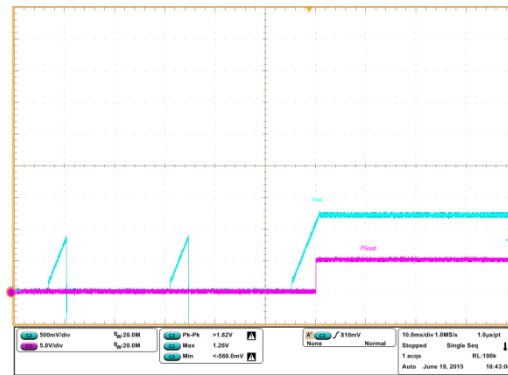

Fig. 9: Short-circuit recovery (Hiccup) at 35A load
 Ch2:V_{out}, Ch3:P_{Good}

TYPICAL OPERATING WAVEFORMS

PVin=12.0V, Vout=1.2V, Iout=0A-35A, Fs=600kHz, Room Temperature, no airflow

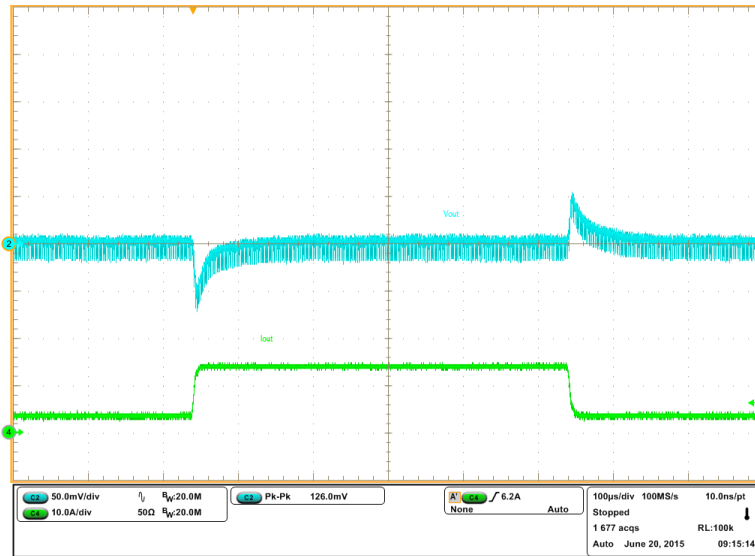

Fig. 10: Transient Response, 3.5A to 14A step (2.5A/us)
 Ch₁:V_{out}, Ch₄:I_{out}

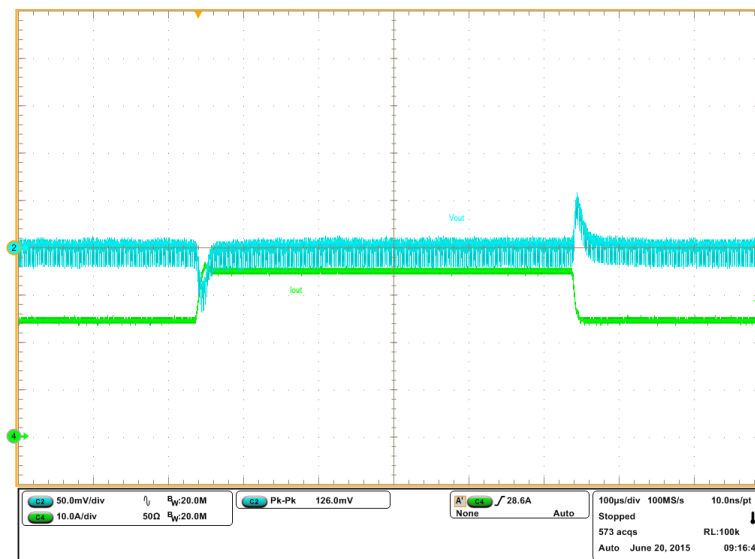

Fig. 11: Transient Response, 24.5A to 35A step (2.5A/us)
 Ch₁:V_{out}, Ch₄:I_{out}

TYPICAL OPERATING WAVEFORMS

PVin=12.0V, Vout=1.2V, Iout=0A-35A, Fs=600kHz, Room Temperature, no airflow

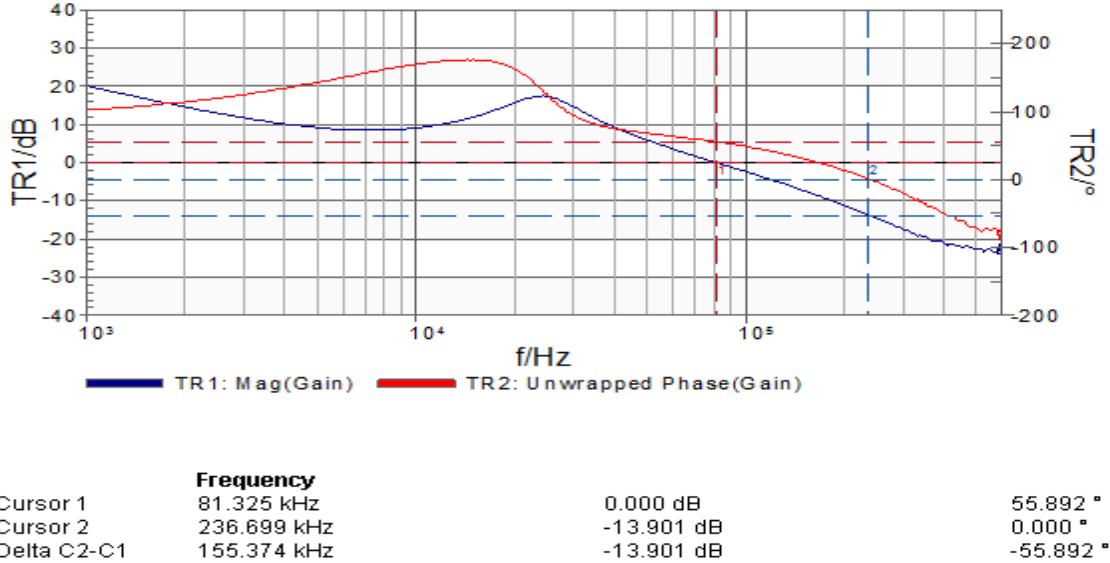

Fig. 12: Bode Plot at 0A load

Bandwidth = 81.33kHz, Phase Margin = 55.89°, Gain Margin = 13.9dB

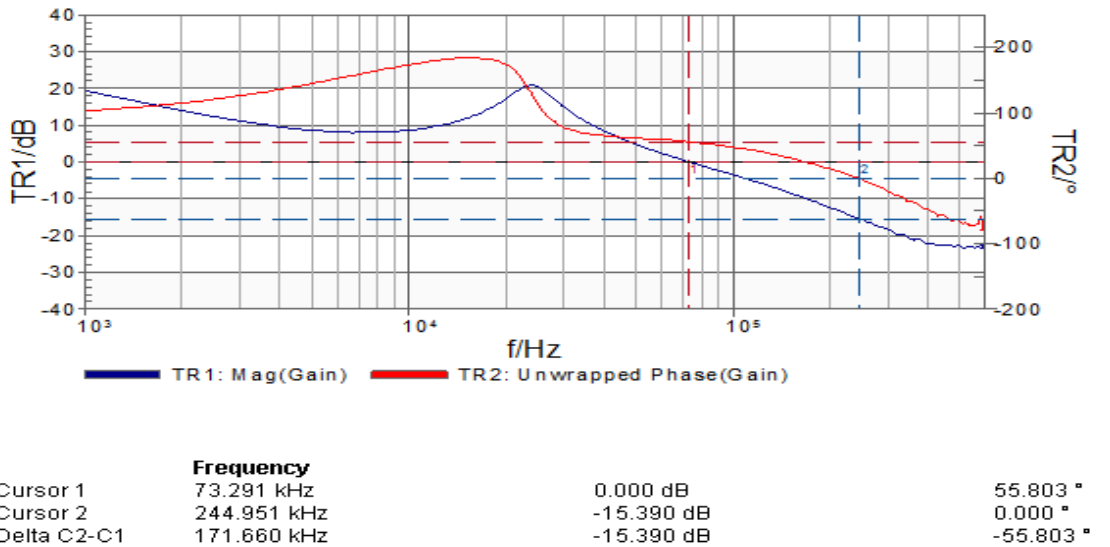

Fig. 13: Bode Plot at 35A load

Bandwidth = 73.3kHz, Phase Margin = 55.8°, Gain Margin = 15.4dB

TYPICAL OPERATING WAVEFORMS
P_{Vin}=12.0V, V_{out}=1.2V, I_{out}=0A-35A, F_s=600kHz, Room Temperature, no airflow

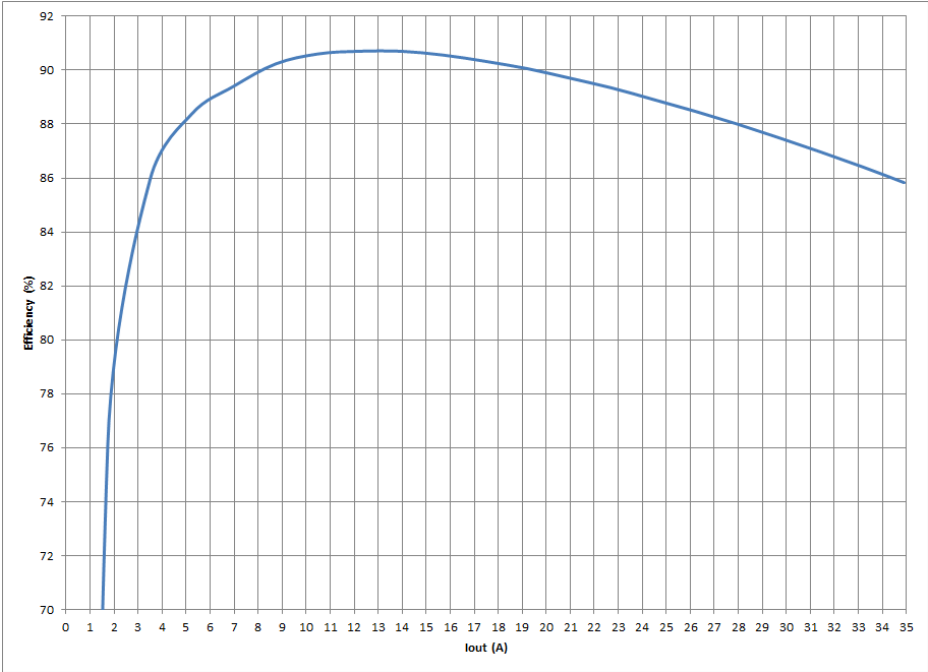

Fig.14: Efficiency versus load current

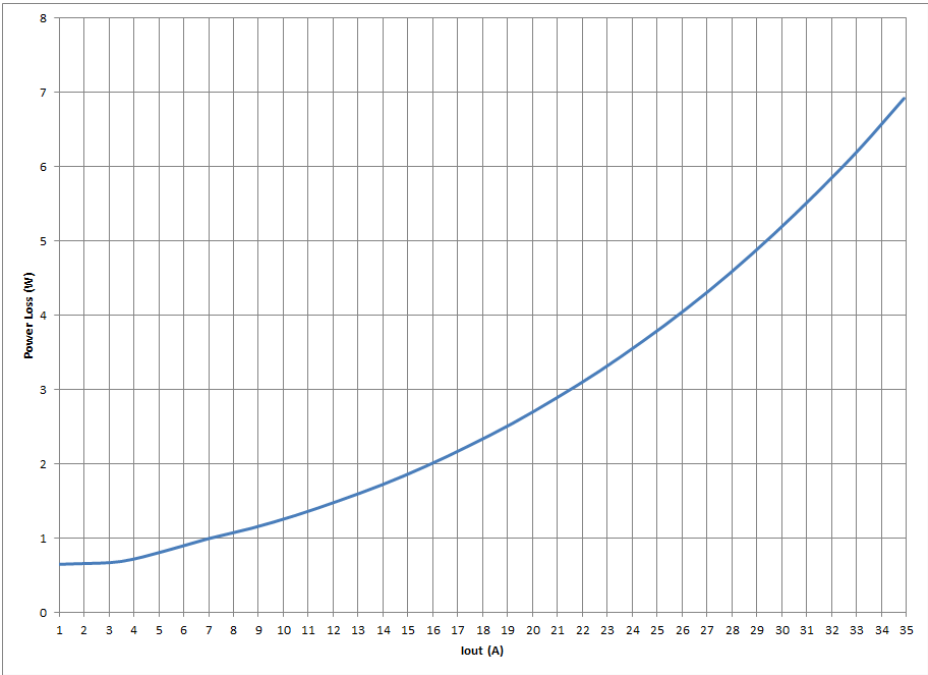

Fig15: Power loss versus load current

THERMAL IMAGE

PVin=12.0V, Vout=1.2V, Iout=0A-35A, Fs=600kHz, Room Temperature, no airflow

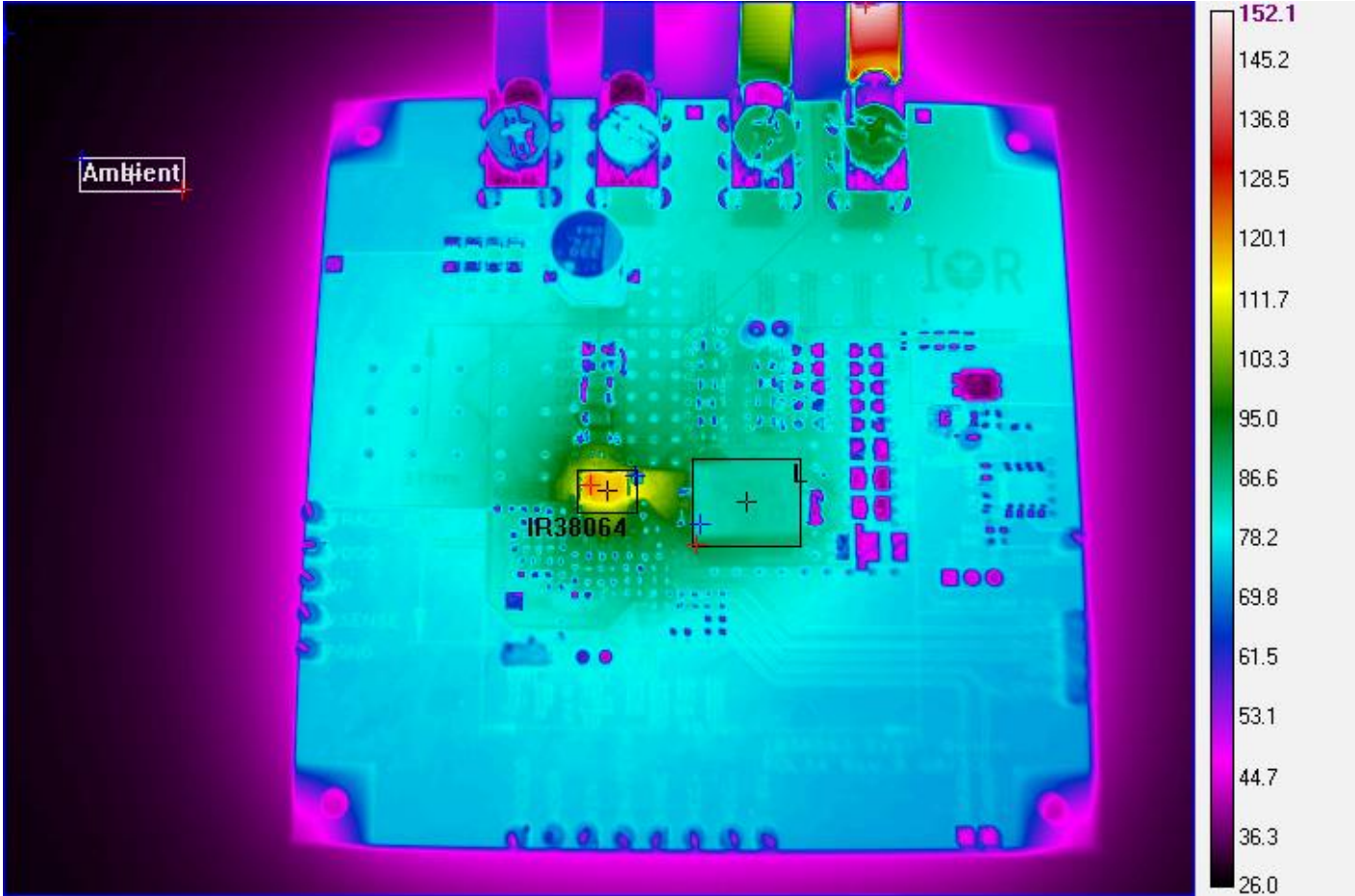

Fig. 16: Thermal Image of the board at 35A load
IR38064: 120.22°C, inductor: 89.89°C, Ambient:29.8°C

PMBus Command Summary

PVin=12.0V, Vout=1.2V, Iout=0A-35A, Fs=600kHz,

Code	Command	Value	Code	Command	Value	Code	Command	Value
01	OPERATION	On	46	IOUT_OC_FAULT_LIMIT	46.000 A	64	TOFF_DELAY	0.0 ms
02	ON_OFF_CONFIG	0x1F	47	IOUT_OC_FAULT_RESPONSE	Immediate off, retry after 20ms	65	TOFF_FALL	6.0 ms
10	WRITE_PROTECT	0x00	4A	IOUT_OC_WARN_LIMIT	39.000 A	78	STATUS_BYTE	0x21
19	CAPABILITY	0xB0	4F	OT_FAULT_LIMIT	145 °C	79	STATUS_WORD	0xA021
1B	SMBALERT_MASK		50	OT_FAULT_RESPONSE	Inhibit	7A	STATUS_VOUT	0xC0
	STATUS_VOUT	00	51	OT_WARN_LIMIT	125 °C	7B	STATUS_IOUT	0x00
	STATUS_IOUT	00	55	VIN_OV_FAULT_LIMIT	24.000 V	7C	STATUS_INPUT	0x28
	STATUS_INPUT	00	56	VIN_OV_FAULT_RESPONSE	Ignore	7D	STATUS_TEMPERATURE	0x00
	STATUS_TEMPERATURE	00	58	VIN_UV_WARN_LIMIT	0.50 V	7E	STATUS_CML	0x00
	STATUS_CML	00	5E	POWER_GOOD_ON	1.074 V	88	READ_VIN	12.125 V
21	VOUT_COMMAND	1.203 V	5F	POWER_GOOD_OFF	1.000 V	8B	READ_VOUT	1.223 V
22	VOUT_TRIM	0.000 V	60	TON_DELAY	0.0 ms	8C	READ_IOUT	0.000 A
24	VOUT_MAX	6.000 V	61	TON_RISE	6.0 ms	8D	READ_TEMPERATURE_1	27 °C
25	VOUT_MARGIN_HIGH	1.258 V	62	TON_MAX_FAULT_LIMIT	0.000 ms	96	READ_POUT	0.000 W
26	VOUT_MARGIN_LOW	1.137 V	63	TON_MAX_FAULT_RESPONSE	Ignore	98	PMBUS_REVISION	0x22
27	VOUT_TRANSITION_RATE	0.125 mV/us	64	TOFF_DELAY	0.0 ms	99	MFR_ID	IR
29	VOUT_SCALE_LOOP	1.000	65	TOFF_FALL	6.0 ms	9A	MFR_MODEL	0x34
33	FREQUENCY_SWITCH	600 KHz	78	STATUS_BYTE	0x21	9B	MFR_REVISION	0x04
35	VIN_ON	1.000 V	79	STATUS_WORD	0xA021	AD	IC_DEVICE_ID	0x34
36	VIN_OFF	0.500 V	7A	STATUS_VOUT	0xC0	AE	IC_DEVICE_REV	0x04
39	IOUT_CAL_OFFSET	0.000 A	7B	STATUS_IOUT	0x00	D6	MFR_I2C_ADDRESS	0x10
40	VOUT_OV_FAULT_LIMIT	1.500 V	7C	STATUS_INPUT	0x28	D8	MFR_TPGDLY	0 ms
41	VOUT_OV_FAULT_RESPONSE	Shutdown	7D	STATUS_TEMPERATURE	0x00	D9	MFR_FCCM	Forced Cont. Conduction M...
42	VOUT_OV_WARN_LIMIT	1.379 V	7E	STATUS_CML	0x00	DB	MFR_VOUT_PEAK	1.223 V
43	VOUT_UV_WARN_LIMIT	1.020 V	88	READ_VIN	12.125 V	DC	MFR_IOUT_PEAK	0.0 A
44	VOUT_UV_FAULT_LIMIT	0.961 V	8B	READ_VOUT	1.223 V	DD	MFR_TEMP_PEAK	27 °C
45	VOUT UV FAULT RESPONSE	Ignore	8C	READ_IOUT	0.000 A			

Fig. 17: PMBus Command Summary for the 1.2V design

Quick Start: PowIRCenter GUI
 Connecting devices

Step 1

**Start PowIRCenter &
 Connect USB Dongle**

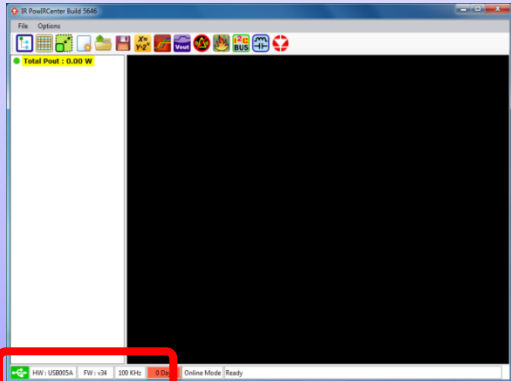

	HW : USB005A	FW : v34	100 KHz	USB Dongle connected
	HW : USBxxx	FW : v	100 KHz	USB Dongle NOT detected

Step 2

Detect attached demoboards



Press "Auto Populate Devices" button to detect boards connected to USB dongle

Quick Start: PowIRCenter GUI Navigation: Accessing Different Views

Step 3 Access different views

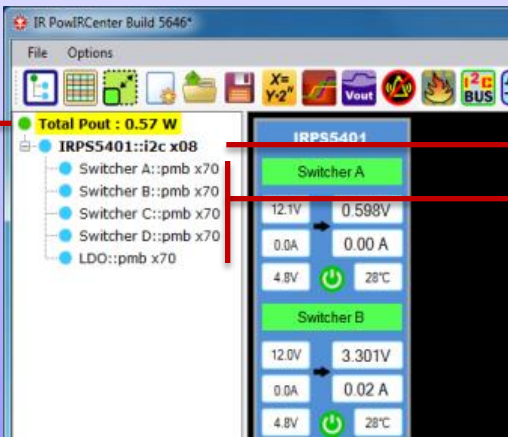

IRPS5401::i2c x08

Click **device name** to access save / load configuration files menu.

Switcher B::pmb x70

Click **channel** to access PMBus commands for selected channel

Access Config File Menu

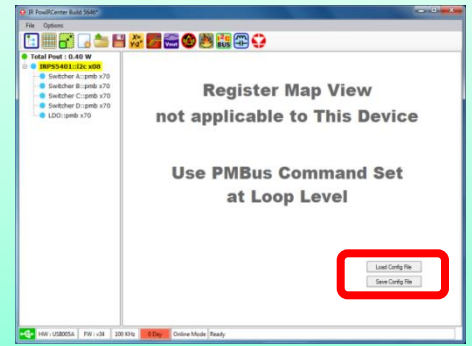

Access Board View

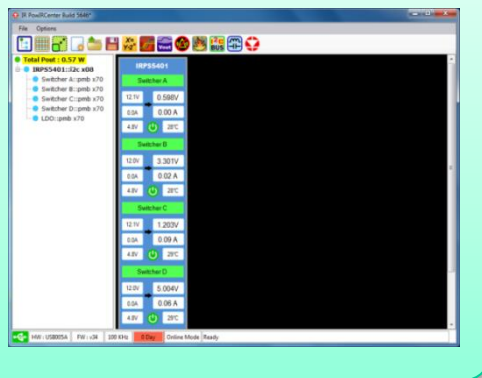

Total Pout : 0.57 W

Click **Total Pout** to return to the Board View

Access PMBus commands

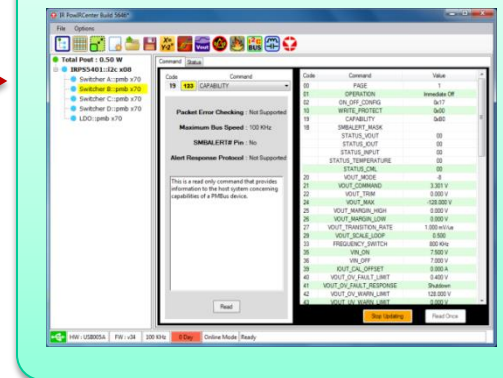

Quick Start: PowIRCenter GUI PMBus Commands

Select Command for Selected Channel

Select command from pull down List

or

Click the command in right panel.

PMBus Command Screen

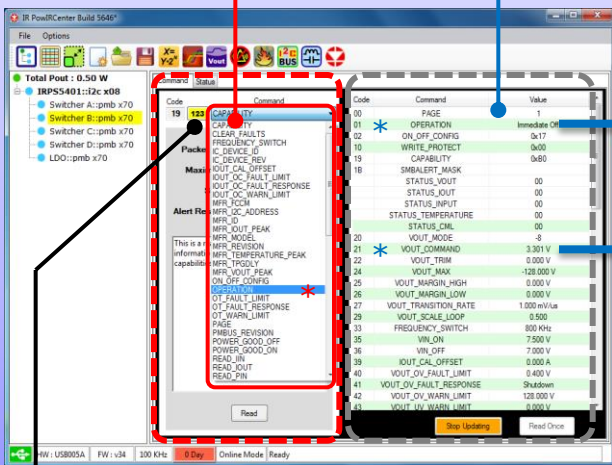

Enable / Disable Channel (Command: OPERATION)

1. Ensure the channel enable is set high on board.
2. Click "On" or "Immediate Off" to turn on or off the channel.
3. Click "Write" button to send the command.

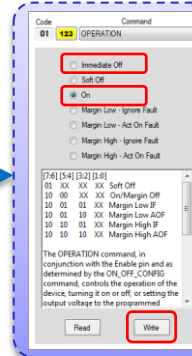

Change Vout (Command: VOUT_COMMAND)

1. Enter Vout voltage.
2. Press enter after entering value.
3. Click "Write" button to send the command.

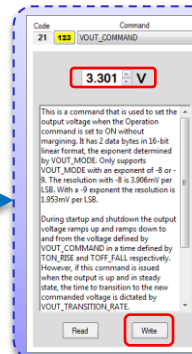

View Basic or All PMBus Commands

Click **A-Z** to sort the PMBus commands by name

Click **123** to sort PMBus commands by operation code