

REVISIONS

P	LTR	DESCRIPTION	DATE	DWN	APVD
A		INITIAL RELEASE	28DEC2015	DL	CW
B		ECR-18-017119	23NOV2018	BS	CW
C		ECR-21-111798	06OCT2021	WQR	CW

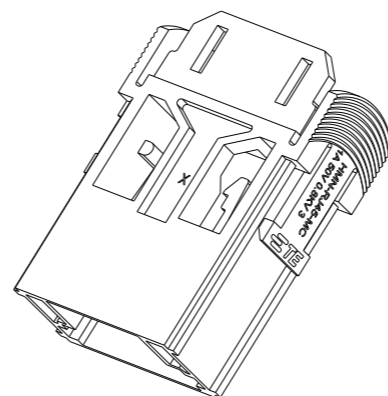
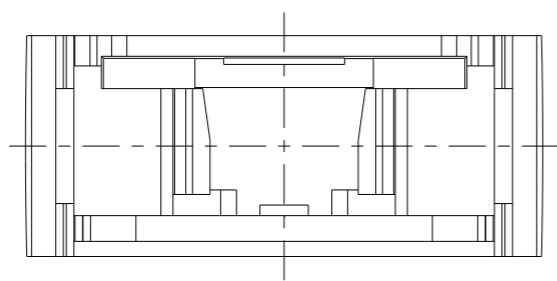

SCALE 1:1

NOTES:

- TECHNICAL CHARACTERISTICS:  
 INSULATION MATERIAL: PC  
 RATED VOLTAGE: 50V  
 RATED CURRENT: 1A  
 INSULATION RESISTANCE:  $\geq 400M\Omega$   
 RATED IMPULSE VOLTAGE: 0.8KV  
 POLLUTION DEGREE: 3  
 FLAMMABILITY: UL94V-0  
 MATING CYCLES: 500

注释:

- 技术参数:  
 绝缘材料: PC  
 额定电压: 50V  
 额定电流: 1A  
 绝缘电阻:  $\geq 400M\Omega$   
 脉冲电压: 0.8KV  
 污染等级: 3  
 阻燃等级: UL94V-0  
 插拔次数: 500

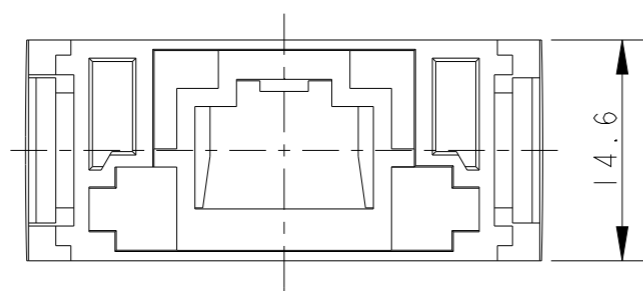
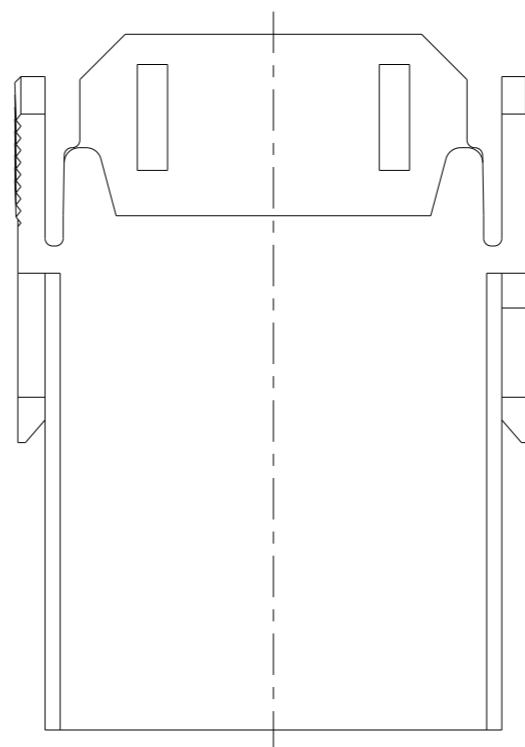
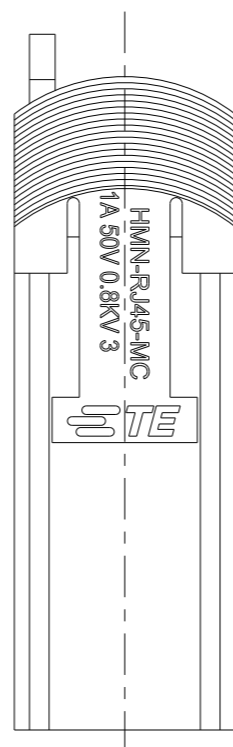
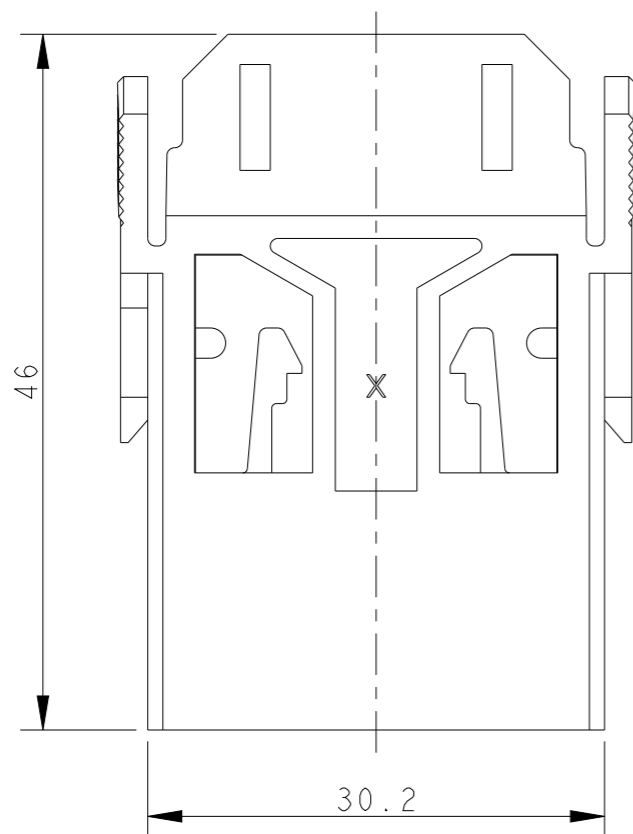
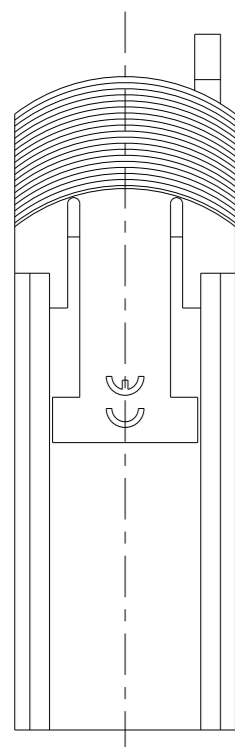

T2113000101-100	HMN-RJ45-MC	HMN-RJ45 MALE MODULE INSERT HMN-RJ45 公插, 压接头
PART NUMBER 料号	PART DESCRIPTION 描述	

THIS DRAWING IS A CONTROLLED DOCUMENT.

DIMENSIONS: mm	TOLERANCES UNLESS OTHERWISE SPECIFIED:
	0 PLC $\pm$ -
	1 PLC $\pm$ -
	2 PLC $\pm$ -
	3 PLC $\pm$ -
	4 PLC $\pm$ -
	ANGLES $\pm$ -
MATERIAL	FINISH
-	-

DWN DAVID LI 28DEC2015	TE Connectivity NAME HMN-RJ45-MC	RESTRICTED TO	
CHK CHRIS WANG 28DEC2015		SIZE A3	CAGE CODE -
APVD XU XIANG 28DEC2015		DRAWING NO T2113000101100	REV C
PRODUCT SPEC 108-137065		SCALE 2:1	SHEET 1 OF 1
APPLICATION SPEC 114-137065	WEIGHT -	CUSTOMER DRAWING	