

# CGA3E2C0G2A101J080AD

TDK Item Description : CGA3E2C0G2A101JT\*\*B



Equivalent C1608C0G2A101J for Automotive

## Application & Main Feature

Automotive Grade ( Conductive Epoxy Application )

## Series

CGA3(1608) [EIA CC0603]

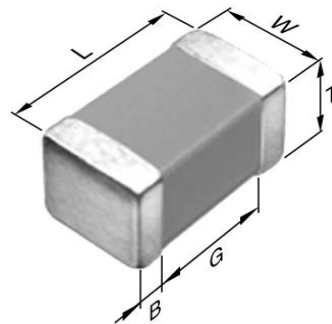

## Dimensions

L 1.60mm +/-0.15mm  
 W 0.80mm +/-0.15mm  
 T 0.80mm +/-0.15mm  
 B 0.20mm Min.  
 G 0.30mm Min.

## Temperature Characteristic

C0G (-55 to 125 degC 0+/-30ppm/degC)

## Rated Voltage

2A (100Vdc)

## Capacitance

100pF

## Capacitance Tolerance

J (+/-5%)

## Q Factor

1000 Min.

## Insulation Resistance

10Gohm Min.

## AEC-Q200

Yes

**|Z|, ESR vs. Freq. Characteristics**

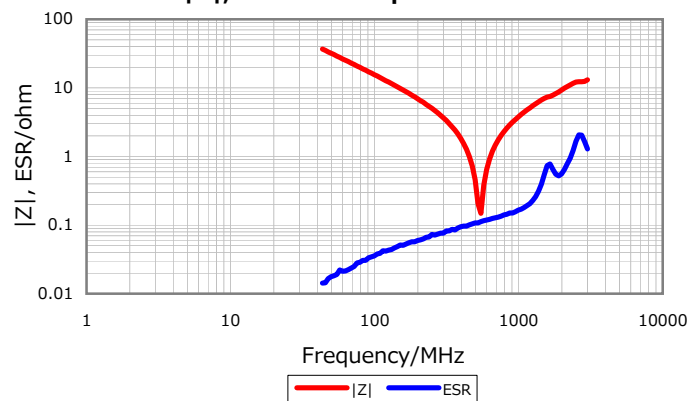

**DC Bias Characteristic**



**Cap. vs. Freq. Characteristic**

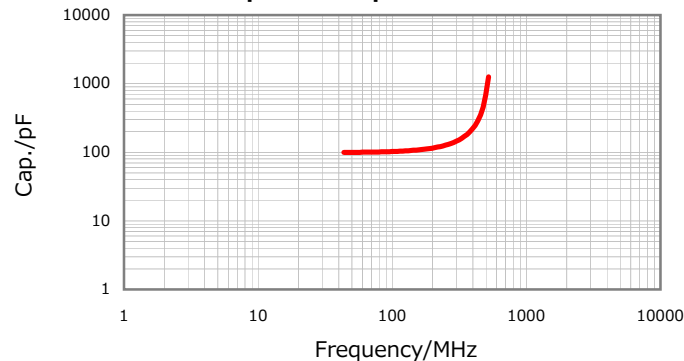

**Temperature Characteristics**



Characterization Sheet ( Multilayer Ceramic Chip Capacitors )



All specifications are subject to change without notice.

January 4, 2016