

DC Solar Disconnect Switches

Series LS16.. to LS65..

- Switching up to 85A 1000VDC (acc. to DC21B/ DC-PV1)
- Designed specifically for the the solar photovoltaic market
- Arc extinguishing contact system
- Snap-action switching speed is independent from the operator
- Patented "ON - OFF - OFF/LOCK" function



	4-Hole Panel Mount	Single-Hole Mount (22.5mm)	Base Mount with Door Coupling	Modular Switch	4-Hole Panel Mount	Single-Hole Mount (22.5mm)	Base Mount with Door Coupling	Modular Switch	Plastic Enclosed
	IP66 NEMA 3R ¹⁾	IP66 NEMA 4X ¹⁾	IP66 NEMA 4X ¹⁾	IP40 ¹⁾ Open Type	IP66 NEMA 3R ¹⁾	IP66 NEMA 4X ¹⁾	IP66 NEMA 4X ¹⁾	IP40 ¹⁾ Open Type	IP66/67 NEMA 4X
LS16	..E..	..Z(O)..	..VZV..	..SMA..	..EH4..	..Z(O)H1..	..VZVH4..	..SMAH1..	..PFLH4..
LS25	..E..	..Z(O)..	..VZV..	..SMA..	..EH4..	..Z(O)H1..	..VZVH4..	..SMAH1..	..PFLH4..
LS32	..E..	..Z(O)..	..VZV..	..SMA..	..EH4..	..Z(O)H1..	..VZVH4..	..SMAH1..	..PFLH4..
LS38	..E..	..Z(O)..	..VZV..	..SMA..	..EH4..	..Z(O)H1..	..VZVH4..	..SMAH1..	..PFLH4..
LS40	..E..	-	..VZV..	..SMA..	..EH4..	-	..VZVH4..	..SMAH1..	..PFLH4..
LS55	..E..	-	..VZV..	..SMA..	..EH4..	-	..VZVH4..	..SMAH1..	..PFLH4..
LS65	..E..	-	..VZV..	..SMA..	..EH4..	-	..VZVH4..	..SMAH1..	..PFLH4..

1) Protection from front and built in

Data According to UL5081

Switch Series	1 Pole			2 Poles in Series			2 Po. in Series + 2 Po. in Parallel			4 Poles in Series			3 Po. in Series + 2 Po. in Parallel			4 Po. in Series + 2 Po. in Parallel		
	350V	600V	1000V	350V	600V	1000V	350V	600V	1000V	350V	600V	1000V	350V	600V	1000V	350V	600V	1000V
LS16 ...	4A	4A	-	16A	16A	-	29A	21A	-	16A	16A	-	29A	21A	-	29A	29A	-
LS25 ...	5A	5A	-	25A	25A	-	45A	27A	-	25A	25A	-	45A	38A	-	45A	45A	-
LS32 ...	6A	6A	-	32A	32A	-	58A	32A	-	32A	32A	-	58A	45A	-	58A	50A	-
LS38 ...	6A	6A	-	38A	36A	-	58A	36A	-	38A	36A	-	58A	45A	-	58A	50A	-
LS40 ...	7.1A	5A	1.5A	40A	40A	16A	72A	42A	22A	40A	40A	40A	72A	52A	33A	80A	65A	42A
LS55 ...	10A	5.8A	2A	55A	55A	20A	85A	55A	25A	55A	55A	55A	85A	65A	42A	85A	85A	64A
LS65 ...	10A	5.8A	2A	65A	65A	25A	85A	65A	25A	65A	65A	65A	85A	72A	48A	85A	85A	70A

Ordering Code Example:

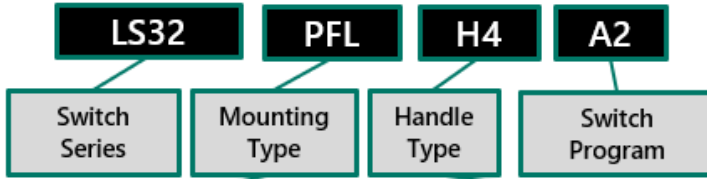

"E" = 4 Hole Panel Mount
 "Z" or "ZO" = Single Hole Panel Mount (ZO is without legend plate)
 "VZV" = Base Mount with door coupling (Single hole panel mount)
 "PFL" = Enclosed

"H4" = Gray & black, round 3-padlock handle
 "H1" = Silver plate with black, 1-padlock knob
 Blank = Silver plate with black knob (not lockable)

Switching programs

Type	2-pole	2+2-pole 2 poles in series +2 poles parallel	4-pole	4-pole with jumpers Input on top Output bottom	4-pole with jumpers Input and Output bottom	4-pole with jumpers Input and Output on top
LS16 ... LS65	.. A2	.. A2+2	..A4(2 x A2)	.. A4B	.. A4O	.. A4U
Contacts Wiring diagram						
Switching example						









Type	6-pole	3+2-pole 3 poles in series +2 poles parallel	8-pole	4+2-pole 4 poles in series +2 poles parallel
LS16 ... LS65	...A6	.. A3+2	...A8	.. A4+2
Contacts Wiring diagram				
Switching example				

Insulated jumpers LSV... for series- and parallel switching of contacts:

for switches

Type

LS16, LS25, LS32, LS38	LSV-B1-1
LS16, LS25, LS32, LS38	LSV-B1-2
LS40, LS55, LS65	LSV-B2-1
LS40, LS55, LS65	LSV-B2-2

Typ	LS16	LS25	LS32	LS38	LS40	LS55	LS65
A40 A4U A4B	2 x  LSV-B1-1		2 x  LSV-B1-2		2 x  LSV-B2-2		
A2+2	4 x  LSV-B1-1				4 x  LSV-B2-1		
A4+2	8 x  LSV-B1-1				8 x  LSV-B2-1		
	2 x  LSV-B1-2				2 x  LSV-B2-2		

Applications:

LS16-38 VZV.. A2+2 LS16-32 VZV.. A40 LS38 VZV.. A40 LS16-38 VZV.. A4+2



2x LSV-B1-1

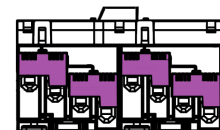

4x LSV-B1-1

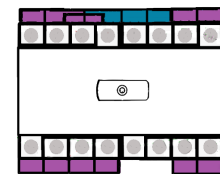
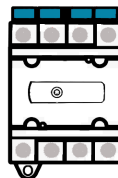
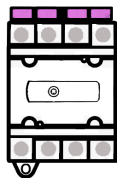
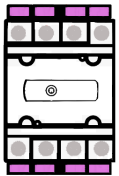

2x LSV-B1-1



2x LSV-B1-1



2x LSV-B1-2

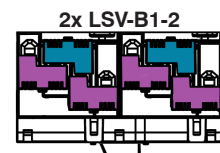

2x LSV-B1-2

4x LSV-B1-1

Specifications are subject to change without notice

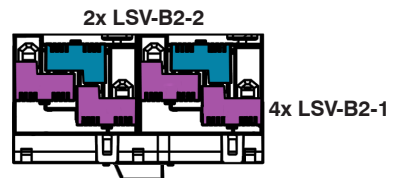
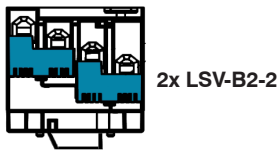
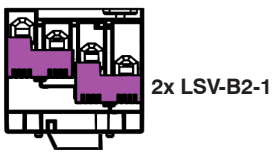
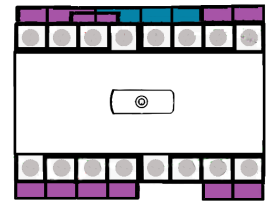
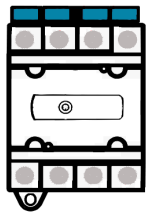
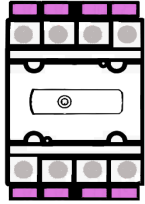
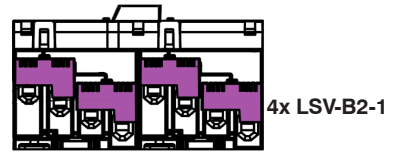
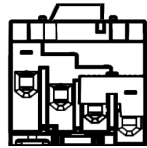

Dimensions

LS16 E.., LS25 E.., LS32 E..,
LS38E.. ..A2
+2, ..A4.

LS16 E.., LS25 E.., LS32 E.., LS38
E ..A6, ..A8, ..A3+2, ..A4+2

LS... +VW"x"
Extended Switch Shaft

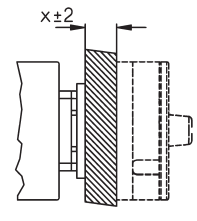
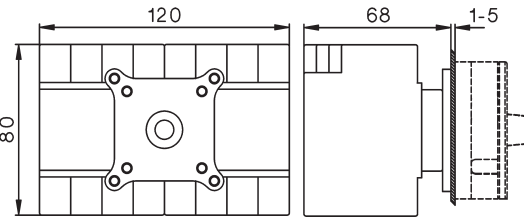
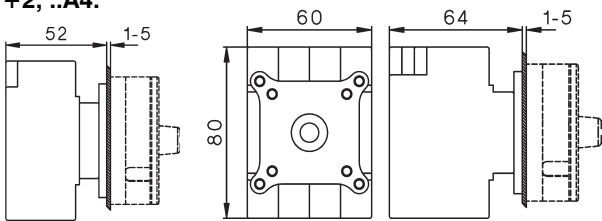

LS40 E.., LS55 E..,
LS65E.. ..A2, ..A2+2, ..A4.

LS40 E.., LS55 E..,
LS65E.. ..A6, ..A8, ..A3
+2, ..A4+2

Mounting hole Mounting
screw: S3631N
M=1,2-1,4 Nm

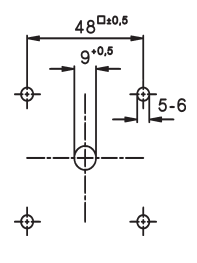
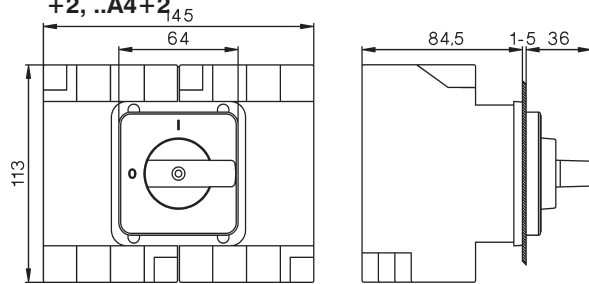
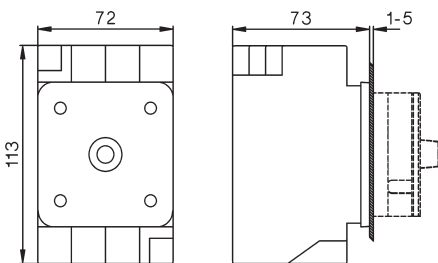

Escutcheon plate 64[□]

Handle

Padlock device SV1.

Padlock device SV4.

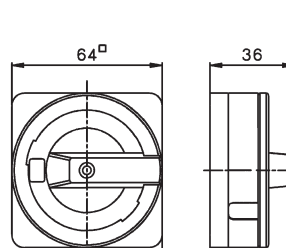
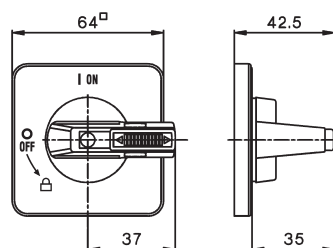
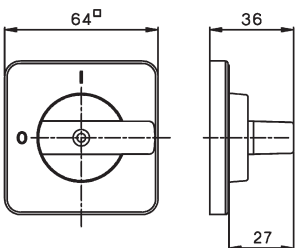

LS16 Z., LS25 Z., LS32 Z., LS38 Z. ..A2

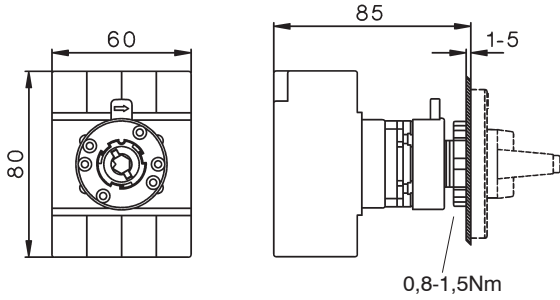

..A2+2, ..A4.

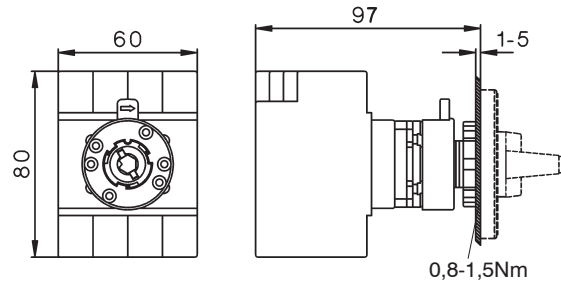

Mounting hole

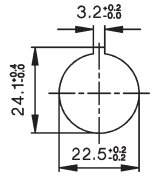

Escutcheon plate 48 □

Handle

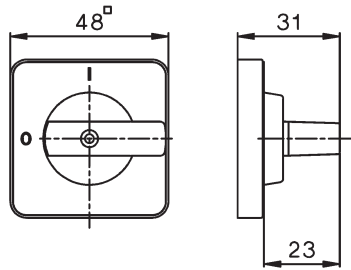

Padlock device SV1.

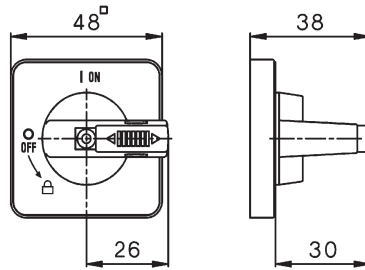

LS16 Z., LS25 Z., LS32 Z., LS38 Z. ..A6, ..A8, ..A3+2, ..A4+2

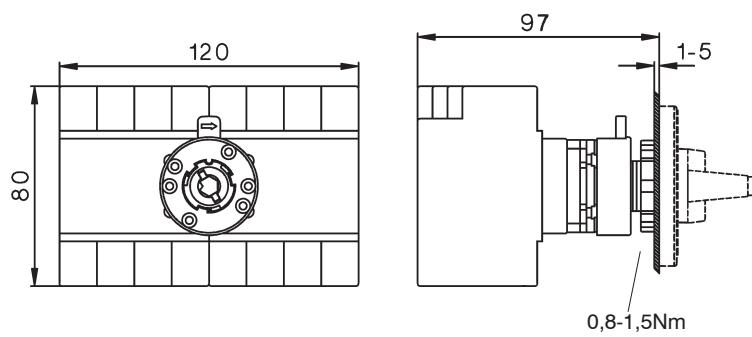

LS..ZO..

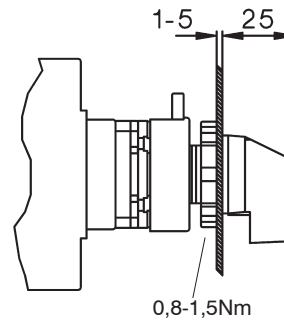

LS16 VZV., LS25 VZV., LS32 VZV., LS38 VZV. ..A2, ..A2+2, ..A4

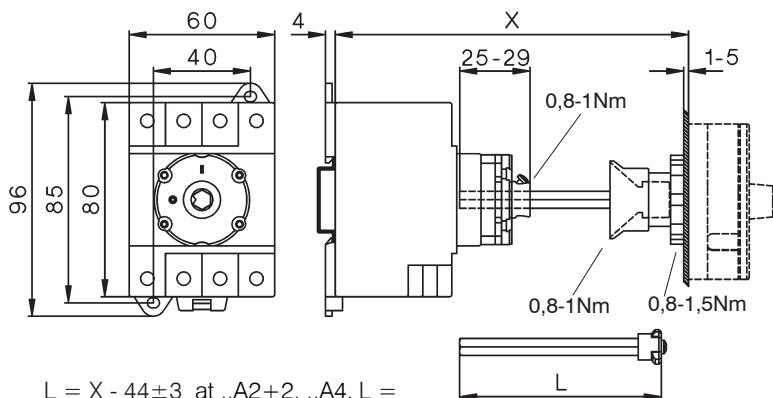

delivered with: ..A2+2, ..A4. $X_{max.} = 194$, $L = 150$
($X_{min.} = 89$)

delivered with: ..A2
 $X_{max.} = 182$, $L = 150$
($X_{min.} = 77$)

Bigger X-Dimensions on request

$L = X - 44 \pm 3$ at ..A2+2, ..A4. $L = X - 32 \pm 3$ at ..A2

LS16 VZV., LS25 VZV., LS32 VZV., LS38 VZV.
..A6, ..A8, ..A3+2, ..A4+2

Mounting hole

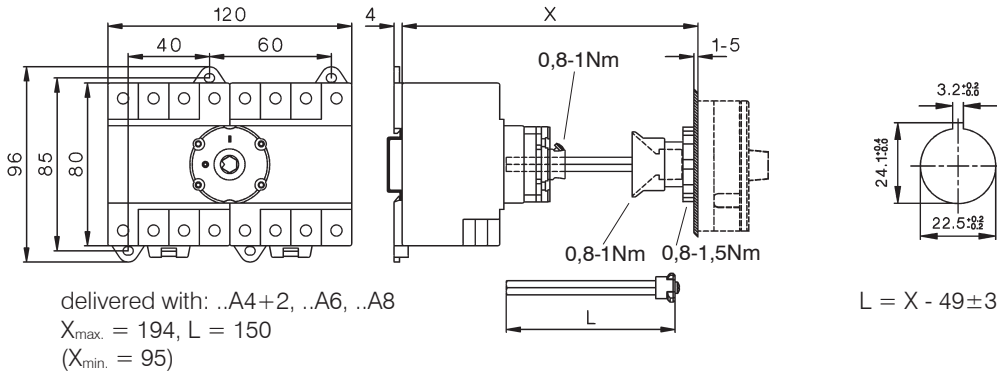

LS40 VZV., LS55 VZV., LS65 VZV.
..A2, ..A2+2, ..A4.

LS40 VZV., LS55 VZV., LS65 VZV.
..A6, ..A8, ..A3+2, ..A4+2

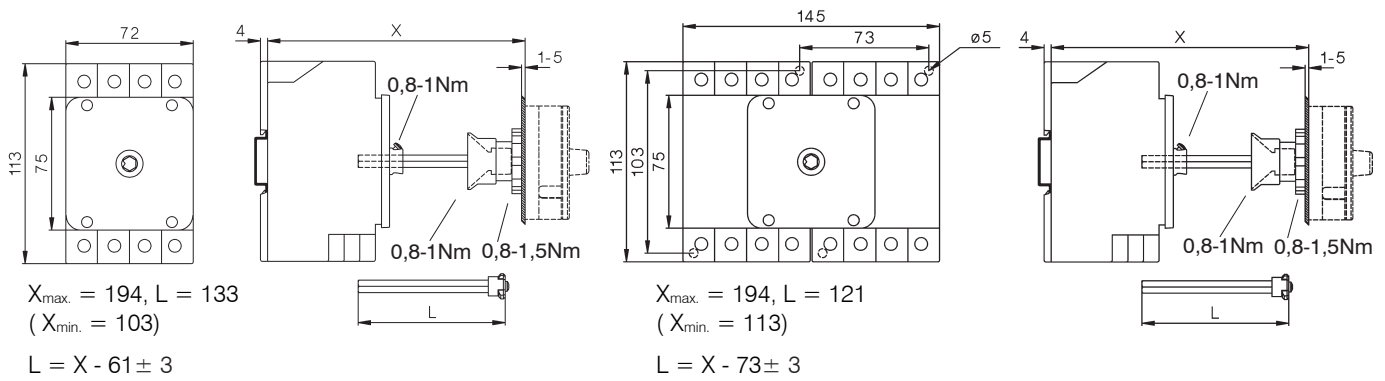

LS16 SMA., LS25 SMA., LS32 SMA., LS38 SMA..
..A2

..A2+2, ..A4

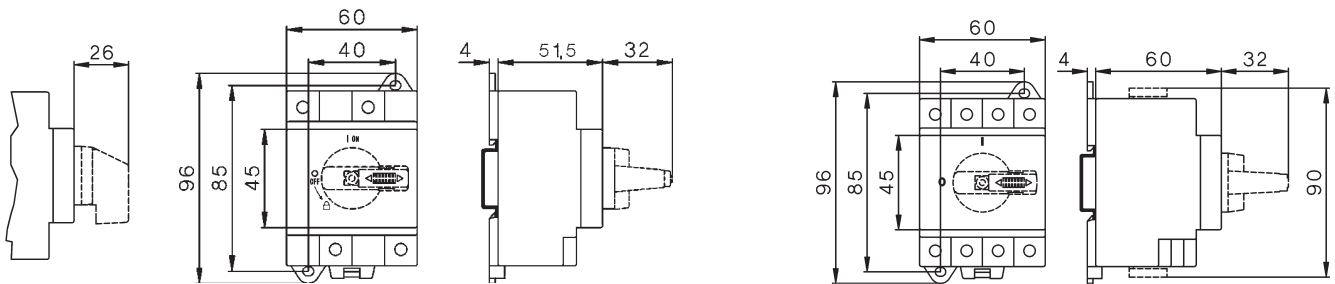

LS40 SMA., LS55 SMA., LS65 SMA..
..A2, ..A2+2, ..A4

LS40 SMA., LS55 SMA., LS65 SMA..
..A6, ..A8, ..A3+2, ..A4+2

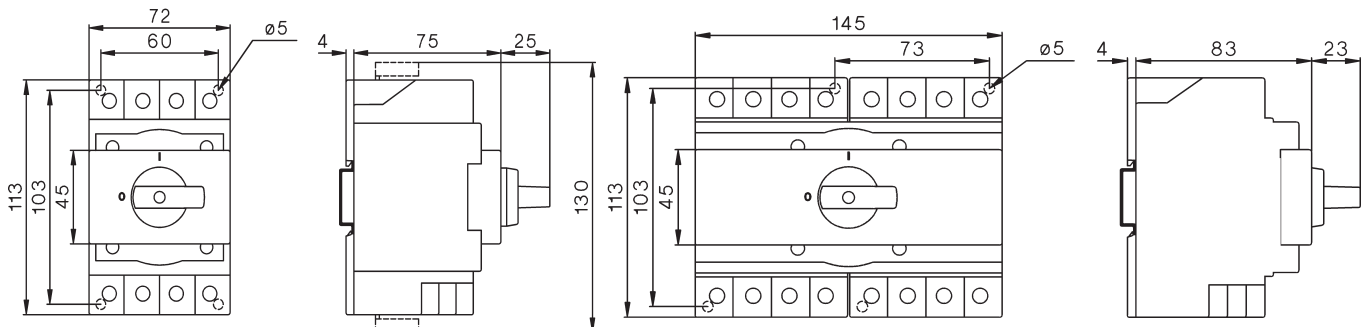

Specifications are subject to change without notice

LS16 SMA.., LS25 SMA.., LS32 SMA.., LS38 SMA..
..A6, ..A8, ..A3+2, ..A4+2

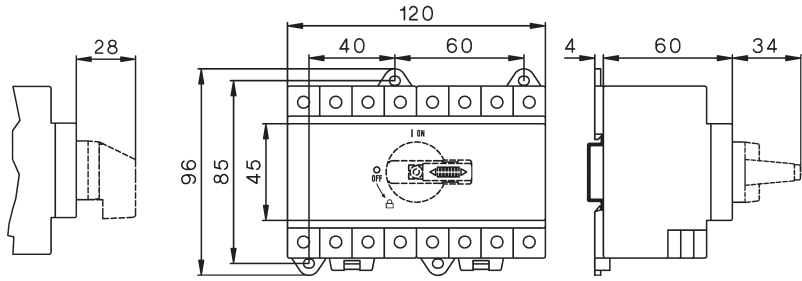

LS.. SMAH1.. with low height handle
A2 +SV1N

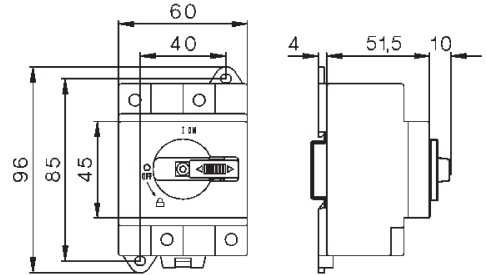

LS16 SMAH1.., LS25 SMAH1.., LS32 SMAH1.., LS38 SMAH1.. with low height handle
A2+2 +SV1N, A4 +SV1N

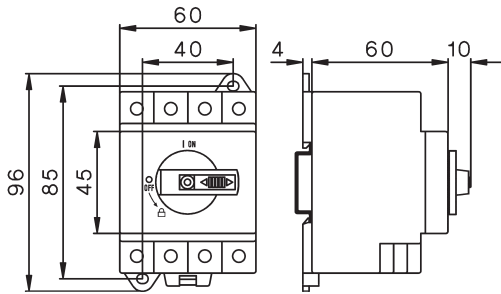

A4+2 +SV1N, A6 +SV1N, A8 +SV1N

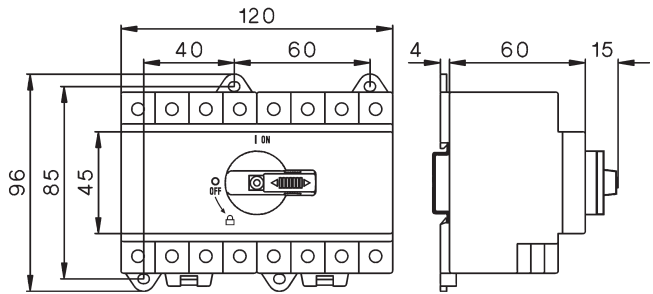

LS16 PFL.., LS25 PFL.., LS32 PFL.., LS38 PFL..
..A2, ..A2+2, ..A4.

Main-Switch (lockable)
LS..PFLH4 A..

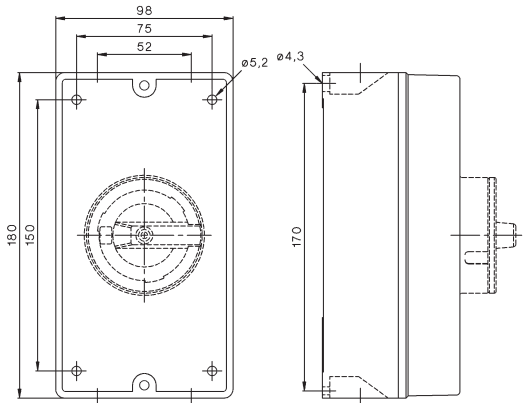
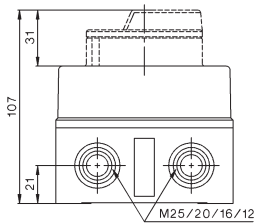

LS16 PFL.., LS25 PFL.., LS32 PFL.., LS38 PFL..
..A2, ..A2+2, ..A4.
+ M2

Main-Switch (lockable)
LS..PFLH4 A..

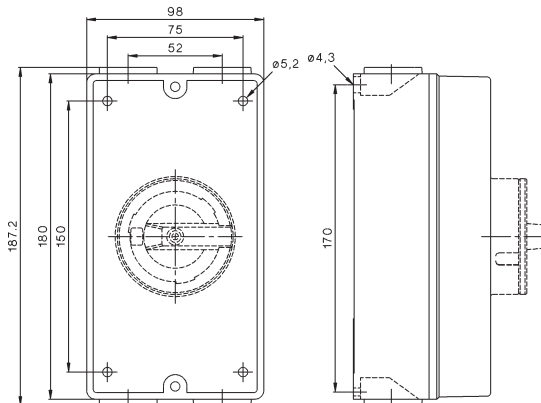
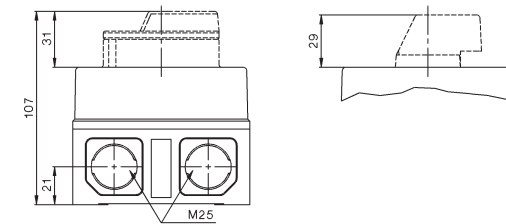

Specifications are subject to change without notice

LS16 PFL..., LS25 PFL..., LS32 PFL..., LS38 PFL...,
..A2, ..A4, ..A6, ..A8, ..A2+2, ..A3+2, ..A4+2
LS40 PFL..., LS55 PFL..., LS65 PFL..
..A6, ..A8, ..A3+2, ..A4+2

Main-Switch (lockable)
LS..PFLH4 A..

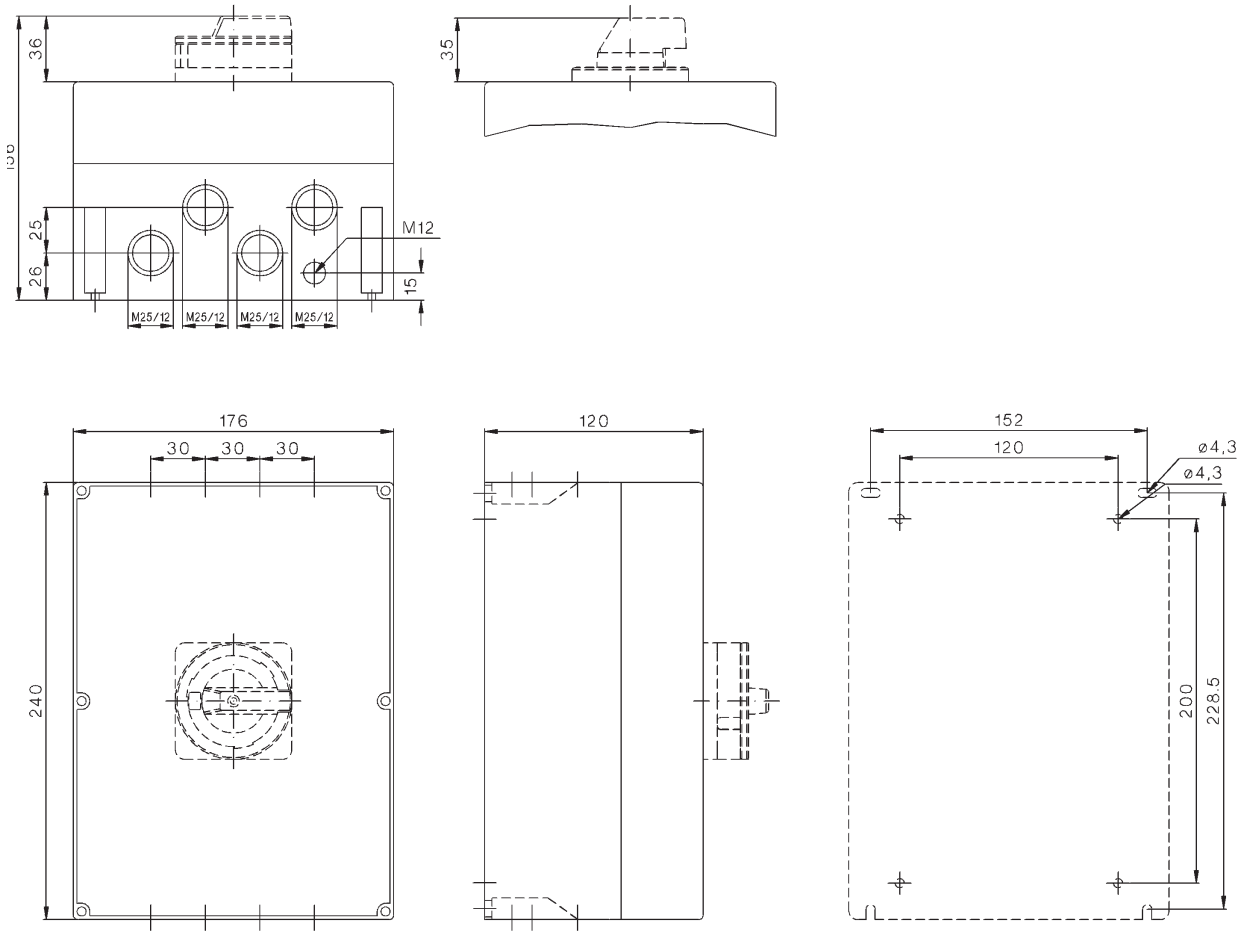

Technical Data

Kind of current	Category	Typical applications	Test conditions for the number of on-load operating cycles (normal service)						Test conditions for making and breaking capacities (operation in fault case)								
			Make		Break		L/R		Make		Break		L/R				
			I/le	U/Ue	L/R	Ic/Ie	Ur/Ue	L/R	I/le	U/Ue	L/R	Ic/Ie	Ur/Ue	L/R			
Direct current	DC21A frequent operation	DC21B infrequent operation	Switching of resistive loads including moderate overloads			1	1	1ms	1	1	1ms	1,5	1,05	1ms	1,5	1,05	1ms
	DC22A frequent operation	DC22B infrequent operation	Switching of mixed resistive a.induct. loads incl. moderate overloads (shunt motors)			1	1	2ms	1	1	2ms	4	1,05	2,5ms	4	1,05	2,5ms
	DC-PV1		Switching of single PV string(s) without reverse- and overcurrents.			1	1	1ms	1	1	1ms	1,5	1,05	1ms	1,5	1,05	1ms
	DC-PV2		Switching of several PV strings with reverse- and overcurrents.			1	1	1ms	1	1	1ms	4	1,05	1ms	4	1,05	1ms



Data according to IEC 60947-3, VDE 0660, GB/T14048.3 (CCC China)

Main contacts			Typ	LS16	LS25	LS32	LS38	LS40	LS55
Rated thermal current I_{th}			A	16	25	32	45	48	55
Rated insulation voltage $U_i^{(1)}$			V	1000	1000	1000	1000	1500	1500
Rated insulation voltage $U_i^{(2)}$			V	1500	1500	1500	1500	1500	1500
Distance of contacts (per pole)			mm	8	8	8	8	8	8
Rated operational current I_e	300V	A	16	23	27	27	40	55	
	400V	A	12/14	14/22	16/25	16/25	30/33	40/44	
DC21A and DC21B	A1	500V	A	9/10	11/17	13/20	13/20	19/24	25/32
	600V	A	6/7	8/12	10/15	10/15	15/19	20/25	
only DC21B	1	700V	A	4,5/5	6	7,5	7,5	10/12	15/18
	800V	A	3	4	5	5	8/10	10/13	
900V	A	2,5/3	3	4	4	6/8	8/10		
	A	1,5/2	2	2,5/3	2,5/3	4/5	6/8		
2 poles in series	500V	A	16	25	32	-/45	48	55	
	600V	A	16	25	32	-/45	48	55	
A2	700V	A	16	23/25	27/32	-/36	35/37	55	
	800V	A	16/16	20	-/23	-/30	35	45/55	
900V	A	13/16	16/17	-/20	-/25	25/31	35/43		
	A	9/10	11/11,5	13	-/20	25/29	-/36		
1200V	A	6/7	8/8,5	10	10	10/11	15/17		
	A	3	4/5	5/6	-/6	6/7,5	7,5/10		
2 poles in series + 2 poles parallel	500V	A	29	45	58	-/65	72	85	
	600V	A	29	45	50/55		64/68	80/85	
A2+2	700V	A	16/22	23/27	27/32		35/49	55/77	
	800V	A	16/17	20	-/23	-/30	35/42	45/63	
900V	A	13/16	16/17	-/20	-/25	25/31	35/43		
	A	9/10	11/11,5	13	-/20	23/29	25/36		
1200V	A	6/7	8/8,5	10		10/11	15/17		
	A	3	4/5	5/6	-/6	6/7,5	7,5/10		
3 poles in series + 2 poles parallel	500V	A	29	45	58		72	85	
	600V	A	29	45	50/58		72	85	
A3+2	700V	A	29	38/43	45/55		72	85	
	800V	A	29	38/40	-/51		68	85	
900V	A	29	-/38	-/47		62	78		
	A	29	-/38	-/45		58	70		
1200V	A	12	14/25	16/28					
	A	9	11/14	13/20					
4 poles in series	500V	A	16	25	32	-/45	48	55	
	600V	A	16	25	32	-/45	48	55	
A4	700V	A	16	25	32		40	55	
	800V	A	16	25	32		40	55	
900V	A	16	25	32		40	55		
	A	16	25	32	-/38	40	55		
1200V	A	16	25	32		40	55		
	A	16	20/25	23/32	-/32	30/40	40/55		
4 poles in series + 2 poles parallel	500V	A	29	45	58	-/65	72	85	
	600V	A	29	45	58		72	85	
A4+2	700V	A	29	45	-/58		72	85	
	800V	A	29	45	-/58		72	85	
900V	A	29	45	-/58		72	85		
	A	29	-/45	-/58	-/65	-/72	-/85		
1200V	A	29	-/45	50	-/50	-/56	-/65		
	A	16	20/26	23/32	-/32	-/42	-/55		
Rated operational current I_e									
AC21B	A2, A4	U_e max. 440V	A	16	25	32	45	48	55
	A2+2	U_e max. 440V	A	29	45	58		72	85

1) Suitable at overvoltage category I to III, pollution degree 3 (standard-industry): $U_{imp} = 8kV$.
 2) Suitable at overvoltage category I to III, pollution degree 2 (min. IP55): $U_{imp} = 8kV$.

Technical Data

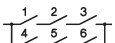
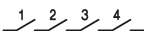
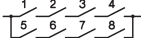

Data according to IEC 60947-3, VDE 0660

Main contacts	Type	LS16	LS25	LS32	LS38	LS40	LS55	
Rated operational current I_e DC-PV1	300V	16	23	27	27	40	55	65
	400V A	14	22	25	25	33	44	50
1 Pole A1 	500V A	10	17	20	20	24	32	40
	600V A	7	12	15	15	19	25	30
	700V A	5	6	7,5	7,5	12	18	21
	800V A	3	4	5	5	10	13	15
	900V A	3	3	4	4	8	10	10
	1000V A	2	2	3	3	5	8	8
2 Poles in series A2 		16	25	32	45	48	55	65
	600V A	16	25	32	45	48	55	65
	700V A	16	25	32	36	37	55	65
	800V A	16	20	23	30	35	55	65
	900V A	16	17	20	25	31	43	55
	1000V A	10	11,5	13	20	29	36	40
	1100V A	8	10	11,5	-	19	25	-
	1200V A	7	8,5	10	10	11	17	17
	1300V A	6	7	8	-	10	14	-
	1400V A	5	6	7	-	9	12	-
	1500V A	3	5	6	6	8	10	10
	2 Poles in series + 2 Pole parallel A2+2 	500V	29	45	58	65	72	85
600V		29	45	55	58	68	85	85
700V A		22	27	32	36	49	77	80
800V A		17	20	23	30	42	63	65
900V A		16	17	20	25	31	43	55
1000V A		10	11,5	13	20	29	36	40
1100V A		8	10	11,5	-	19	25	-
1200V A		7	8,5	10	10	11	17	17
1300V A		6	7	8	-	10	14	-
1400V A		5	6	7	-	9	12	-
1500V A		3	5	6	6	8	10	10
3 Poles in series + 2 Poles parallel A3+2 			29	45	58	-	72	85
		29	45	58	-	72	85	-
	700V A	29	43	55	-	72	85	-
	800V A	29	40	51	-	68	85	-
	900V A	29	38	47	-	62	78	-
	1000V A	29	38	45	-	58	70	-
	1100V A	19	27	37	-	-	-	-
	1200V A	17	25	28	-	-	-	-
	1300V A	15	21	25	-	-	-	-
	1400V A	12	18	22	-	-	-	-
1500V A	10	14	20	-	-	-	-	
4 Poles in series A4 	500V	16	25	32	45	48	55	65
	600V A	16	25	32	45	48	55	65
	700V A	16	25	32	45	48	55	65
	800V A	16	25	32	45	48	55	65
	900V A	16	25	32	45	48	55	65
	1000V A	16	25	32	38	40	55	65
	1100V A	16	25	32	-	40	55	65
	1200V A	16	25	32	32	40	55	65
	1300V A	16	25	32	-	40	55	65
	1400V A	16	25	32	-	40	55	65
	1500V A	16	25	32	32	40	55	65
	4 Poles in series + 2 Poles parallel A4+2 	500V	29	45	58	65	72	85
		29	45	58	65	72	85	85
700V A		29	45	58	65	72	85	85
800V A		29	45	58	65	72	85	85
900V A		29	45	58	65	72	85	85
1000V A		29	45	58	65	72	85	85
1100V A		29	45	54	-	60	68	-
1200V A		29	45	50	50	56	65	65
1300V A		26	39	44	-	50	61	-
1400V A		23	33	38	-	46	-	-
1500V A		20	26	32	32	42	55	55

Specifications are subject to change without notice

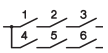
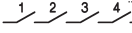
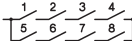

Technical Data

Data according to IEC 60947-3, VDE 0660

Main contacts	Type	LS16	LS25	LS32	LS38	LS40	LS55	
Rated operational current I_e								
DC-PV2 1 Pole A1 	300V	16	23	27	27	40		
	400V	14	18	20	20	30	-	
	500V	10	12	14	14	19		
	600V	5	6	8	8	10	-	
	700V	1,5	2	3	3	7	-	
	800V	1,5	2	3	3	6	-	
	900V	1	1,5	2	2	5	-	
	1000V	1	1,5	2	2	3	-	
	2 Poles in series A2 	500V	16	25	32	38	40	65
		600V	14	21	27	31	40	65
700V		13	19	22	25	35	65	
800V		12	15	17	19	33	52	
900V		8	10	12	14	25	38	
1000V		4	5	6	7	16	20	
1100V		3	4	5	-	11	-	
1200V		2	3	4	4	8	12	
1300V		1,5	2	3	-	7	-	
1400V		1	2	3	-	7	-	
1500V		1	1,5	2	2	6	8	
2 Poles in series + 2 poles parallel A2+2 	500V	25	39	50	58	72	85	
	700V	20	32	35	38	33	75	
	800V	13	19	22	25	25	65	
	900V	12	15	17	19	33	52	
	1000V	8	10	12	14	25	38	
	1100V	4	5	6	7	16	20	
	1200V	3	4	5	-	11	-	
	1300V	2	3	4	4	8	12	
	1400V	1,5	2	3	-	7	-	
	1500V	1	2	3	-	7	-	
	1500V	1	1,5	2	2	6	8	
3 Poles in series + 2 poles parallel A3+2 	500V	24	45	58	65	72	-	
	700V	22	34	44	48	78	-	
	800V	20	28	34	35	62	-	
	900V	18	24	29	31	53	-	
	1000V	16	20	24	24	55	-	
	1100V	14	18	20	20	35	-	
	1200V	-	-	-	-	-	-	
	1300V	11	13	15	15	-	-	
	1400V	-	-	-	-	-	-	
	1500V	-	-	-	-	-	-	
	1500V	4	6	8	8	-	-	
4 Poles in series A4 	500V	16	25	32	45	48	65	
	600V	16	25	32	45	48	65	
	700V	16	25	32	45	48	65	
	800V	16	25	32	38	40	65	
	900V	16	25	32	38	40	65	
	1000V	16	25	32	38	40	65	
	1100V	15	25	32	-	-	55	
	1200V	13,5	21	27	27	40	55	
	1300V	12	19	24	-	-	50	
	1400V	10,5	16	21	-	-	45	
	1500V	9	14	18	18	30	40	
4 Poles in series + 2 poles parallel A4+2 	500V	29	45	58	65	72	-	
	700V	29	45	58	65	72	-	
	800V	25	40	53	65	72	-	
	900V	21	35	45	60	67	-	
	1000V	18	30	37	55	59	-	
	1100V	16	25	32	50	52	-	
	1200V	-	-	-	-	44	-	
	1300V	13,5	21	27	27	40	-	
	1400V	-	-	-	-	36	-	
	1500V	-	-	-	-	33	-	
	1500V	9	14	18	18	30	-	



Technical Data

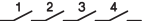







Data according to IEC 60947-3, VDE 0660

Main contacts		Type	LS16	LS25	LS32	LS38	LS40	LS55/LS65
Rated operational current I_e		500V	1	1,25	1,5	x	x	2,5
DC22B		600V	0,5	0,75	1	x	x	2,0
1 pole		800V	0,3	0,4	0,5	x	x	1,5
A1		1000V	0,15	0,2	0,25	x	x	1,0
		1200V	-	-	-	x	x	x
		1500V	-	-	-	x	x	x
2 poles in series								
A2		600V	7	8	9	x	x	x
		800V	5,5	6	6,5	x	x	x
		1000V	2	2,5	3	x	x	x
		1200V	1	1,5	2	x	x	x
		1500V	-	-	-	x	x	x
4 poles in series								
A4		600V	16	25	32	x	x	x
		800V	16	25	27,5	x	x	x
		1000V	11,5	12	12,5	x	x	x
		1200V	8	9	10	x	x	x
		1500V	-	-	-	x	x	x
Rated conditional short-circuit current		kA _{eff}	5	5	5	5	10	10
Max. fuse size		gL (gG)	40	63	80	80	125	160
Mechanical life		³	10	10	10	10	10	10
Rated short-time withstand current (1s)		I _{cw} A2, A4, A6, A8 A2+2, A3+2, A4+2	800 1300	900 1500	1000 1700	1000 1700	A2, A4: 1200 A2+2: 2000	A2, A4: 1400 A2+2: 2400
Short circuit making capacity		I _{cm} A2, A4, A6, A8 A2+2, A4+2	800 1300	900 1500	1000 1700	1000 1700	A2, A4: 1200 A2+2: 2000	A2, A4: 1400 A2+2: 2400
Maximum cable cross sections (incl. jumper)			-B1	LSV-B1	LSV-B1	LSV-B1	LSV-B2	LSV-B2
solid or stranded		mm ²	4 - 16	4 - 16	4 - 16	4-16	2,5 - 25	2,5 - 25
flexible		mm ²	4 - 10	4 - 10	4 - 10	4-10	2,5 - 16	2,5 - 16
flexible (+ multicore cable end)		mm ²	4 - 10	4 - 10	4 - 10	4-10	1,5 - 16	1,5 - 16
Size of terminal screw			M4 Pz2	M4 Pz2	M4 Pz2	M4 Pz2	M5 Pz2	M5 Pz2
Tightening torque		Nm	1,8 - 2	1,8 - 2	1,8 - 2	1,8 - 2	2,5 - 2,8	2,5 - 2,8
2 cables per terminal without jumper LSV-B1 / LSV-B2								
solid or stranded		mm ²	16+(1,5-2,5) / 10+(1,5-6) / 6+(1,5-10) / 4+(1,5-10)				16+(1,5-2,5) / 10+(1,5-10) / 6+(1,5-10) / 4+(1,5-10)	
flexible & flexible + multicore cable end		mm ²	16+(1,5-2,5) / 10+(1,5-4) / 6+(1,5-6)				16+(1,5-6) / 10+(1,5-10) / 6+(1,5-16) / 4+(1,5-16)	
stranded		AWG	8+(16-12) / 10+(16-10) / 12+(16-8) 14+(16-8)				3+(18-10) / 4+(18-10) / 6+(18-8) 8+(18-8)	
solid		AWG	10+(16-12) / 12+(16-10) 14+(16-10)				10+(16-10) / 12+(16-10) / 14+(16-10) 12+(16-10)/14+(16-10)	
Maximum ambient temperature								
Operation		open enclosed °C	-40 to +65					
Storage		°C	-40 to +45					
			-50 to +90					
Power loss per switch at I _e max.			A	A	A		A	A
A2		(A)/W	(16)/ 1	(25)/ 2,3	(32)/ 3,7		(40)/ 4	(55)/ 7,5
A4		(A)/W	(16)/ 2	(25)/ 4,6	(32)/ 7,4		(40)/ 8	(55)/ 15
A6		(A)/W	(16)/ 3	(25)/ 6,9	(32)/ 11,1		(40)/ 12	(55)/ 22,5
A8		(A)/W	(16)/ 4	(25)/ 9,2	(32)/ 14,8		(40)/ 16	(55)/ 30
A2+2		(A)/W	(29)/1,5	(45)/ 3,7	(58)/ 6		(72)/ 6,5	(85)/ 9
A3+2		(A)/W	(29)/2,3	(45)/ 5,6	(58)/ 9		(72)/ 9,8	(85)/ 14
A4+2		(A)/W	(29)/3	(45)/ 7,4	(58)/ 12		(72)/ 13	(85)/ 18
Contact resistance per pole		Ω	1,75	1,75	1,75		1,25	1,25

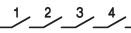
x pending

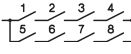
Technical Data

Daten according to UL508I  File E359344 Category np.: NMSJ and UL508 

Typ				LS16	LS25	LS32	LS38	LS40	LS55	LS65	
Ampere-Rating "General use"  1 Pole	DC	350V	A		5	6	6	7,1	1		
		500V	A		5	6	6	5,7			
		600V	A		5	6	6	5,0			
		700V	A		-	-	-	3,9	5,0		
		800V	A		-	-	-	3,2	4,4		
		900V	A		-	-	-	2,5	3,5		
		1000V	A		-	-	-	1,5	2,0		
		 2 Poles in series A2	350V	A		25	32	45	48	55	
			500V	A		25	32	45	48	55	
			600V	A		25	32	36	40	55	
700V	A			-	-	-	32	46			
800V	A			-	-	-	26	37			
900V	A			-	-	-	20	28			
1000V	A			-	-	-	16	20			
 2 Poles in series + 2 poles parallel A2+2	350V	A		45	58	58	72	85			
	500V	A		41	43	45	53	66			
	600V	A		30	33	36	42	55			
	700V	A		-	-	-	35	47	5		
	800V	A		-	-	-	30	40			
	900V	A		-	-	-	26	32			
	1000V	A		-	-	-	22	25			
 4 Poles in series A4	350V	A		25	32	45	48	55			
	500V	A		25	32	45	48	55			
	600V	A		25	32	36	40	55			
	700V	A		-	-	-	40	55			
	800V	A		-	-	-	40	55			
	900V	A		-	-	-	40	55			
	1000V	A		-	-	-	40	55			
 3 Poles in series + 2 poles parallel A3+2	350V	A		45	58	58	72	85			
	500V	A		41	50	50	56	80			
	600V	A		38	45	45	52	65			
	700V	A		-	-	-	46	58			
	800V	A		-	-	-	40	51			
	900V	A		-	-	-	36	45			
	1000V	A		-	-	-	33	42			
 4 Poles in series + 2 poles parallel A4+2	350V	A		45	58	58	80	85			
	500V	A		45	58	58	71	85			
	600V	A		45	50	50	65	85			
	700V	A		-	-	-	58	76			
	800V	A		-	-	-	51	71			
	900V	A		-	-	-	45	67			
	1000V	A		-	-	-	42	64			
AC-Rating "General use"											
2 Poles in series		1 phase	600V	A	25	32	-	40	55		
2 Poles in series		1 phase	277V	A	-	50	-	72	85	-	
+ 2 poles parallel											
3 Poles parallel		3 phase	480V	A	-	32	-	40	55		
Fuse size (RK5) Industrial Control Switch											
5kA / 600V			A		60	80	80	-	-		
5kA/1000V			A		-	-	-	160	160		
Max. cable cross sections incl. jumpers LSV-B1 / LSV-B2											
solid	AWG			12 -	12 - 10	12 - 10	12 - 10	16 - 10	16 - 10		
flexible or stranded	AWG			12 -	12 - 6	12 - 6	12 - 6	14 - 3	14 - 3		
flexible (+ multicore cable end)	AWG			12 -	12 - 6	12 - 6	12 - 6	16 - 4	16 - 4		
Size of terminal screw				M4 Pz2	M4 Pz2	M4 Pz2	M4 Pz2	M5 Pz2	M5 Pz2		
Tightening torque	Nm			1	1,8 - 2	1,8 - 2	1,8 - 2	2,5 - 2,8	2,5 - 2,8		
Protection class of terminals ¹⁾				IP20	IP20	IP20	IP20	IP20	IP20		

1) Protection class of the terminals with connected, insulated conductors.

Technical Data

Example for maximum currents according to ambient temperatures and cable cross sections:

Switch **open** LS16.., 2 contacts in series (A2)

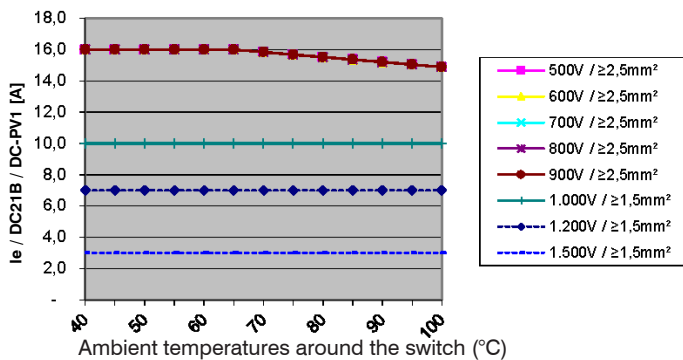

Switch **open** LS16 .., 2 contacts in series + 2 parallel (A2+2)

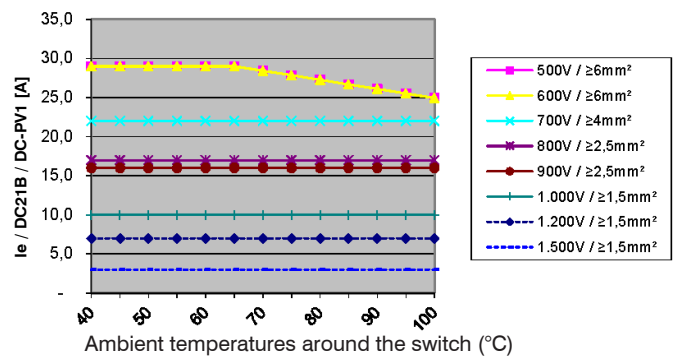

Switch **enclosed** LS16 PFL..., 2 contacts in series (A2)

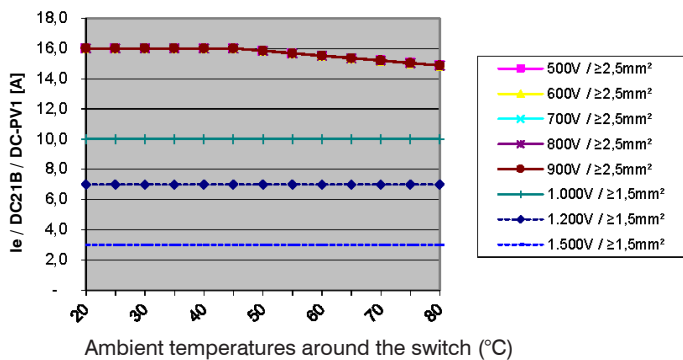

Switch **enclosed** LS16 PFL..., 2 contacts in series + 2 parallel (A2+2)

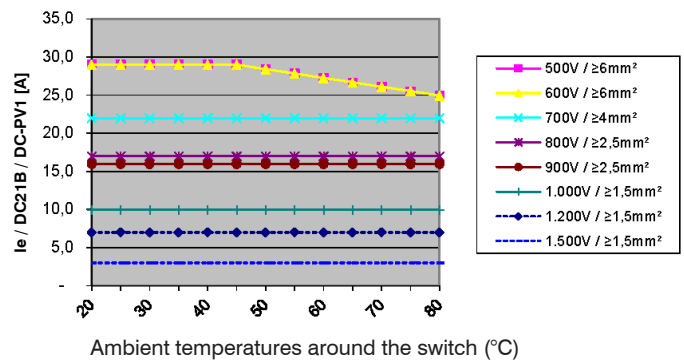

Please contact B&J-USA for full data regarding maximum currents according to ambient temperatures and cable cross sections for switches LS16.. to LS65.. (open or enclosed).

Approvals

Country	USA, UL508I	US, Canada UL508	Europe	China CCC	CB-Certificates	EAC
Type						
LS16	o	o	/	o	o	o
LS25	o	o	/	o	o	o
LS32	o	o	/	o	o	o
LS38	o	o	/	o	o	o
LS40, LS55	o	o	/	o	o	o
LS65	o	o	/	-	o	o

o In standard version approved / No testing required CE x In test Not provided for test