

Evaluation platform 1200 V CoolSiC™ MOSFET in TO247 3-pin / 4-pin Rev. 2.0

Switching loss extraction for surface mount and through hole devices

About this document

Scope and purpose

This user guide describes the double-pulse evaluation platform, which is used to extract switching losses for discretes in TO247 3-pin and 4-pin packages, and the daughter cards that fit on the board.

Intended audience

This document is intended for owners and users of the evaluation board. Only trained persons should operate the board!

Important notice

Important notice

“Evaluation Boards and Reference Boards” shall mean products embedded on a printed circuit board (PCB) for demonstration and/or evaluation purposes, which include, without limitation, demonstration, reference and evaluation boards, kits and design (collectively referred to as “Reference Board”).

Environmental conditions have been considered in the design of the Evaluation Boards and Reference Boards provided by Infineon Technologies. The design of the Evaluation Boards and Reference Boards has been tested by Infineon Technologies only as described in this document. The design is not qualified in terms of safety requirements, manufacturing and operation over the entire operating temperature range or lifetime.

The Evaluation Boards and Reference Boards provided by Infineon Technologies are subject to functional testing only under typical load conditions. Evaluation Boards and Reference Boards are not subject to the same procedures as regular products regarding returned material analysis (RMA), process change notification (PCN) and product discontinuation (PD).

Evaluation Boards and Reference Boards are not commercialized products, and are solely intended for evaluation and testing purposes. In particular, they shall not be used for reliability testing or production. The Evaluation Boards and Reference Boards may therefore not comply with CE or similar standards (including but not limited to the EMC Directive 2004/EC/108 and the EMC Act) and may not fulfill other requirements of the country in which they are operated by the customer. The customer shall ensure that all Evaluation Boards and Reference Boards will be handled in a way which is compliant with the relevant requirements and standards of the country in which they are operated.

The Evaluation Boards and Reference Boards as well as the information provided in this document are addressed only to qualified and skilled technical staff, for laboratory usage, and shall be used and managed according to the terms and conditions set forth in this document and in other related documentation supplied with the respective Evaluation Board or Reference Board.

It is the responsibility of the customer’s technical departments to evaluate the suitability of the Evaluation Boards and Reference Boards for the intended application, and to evaluate the completeness and correctness of the information provided in this document with respect to such application.

The customer is obliged to ensure that the use of the Evaluation Boards and Reference Boards does not cause any harm to persons or third party property.

The Evaluation Boards and Reference Boards and any information in this document is provided "as is" and Infineon Technologies disclaims any warranties, express or implied, including but not limited to warranties of non-infringement of third party rights and implied warranties of fitness for any purpose, or for merchantability.

Infineon Technologies shall not be responsible for any damages resulting from the use of the Evaluation Boards and Reference Boards and/or from any information provided in this document. The customer is obliged to defend, indemnify and hold Infineon Technologies harmless from and against any claims or damages arising out of or resulting from any use thereof.

Infineon Technologies reserves the right to modify this document and/or any information provided herein at any time without further notice.

Safety precautions

Note: Please note the following warnings regarding the hazards associated with development systems.

Table 1 Safety precautions







	<p>Warning: The DC link potential of this board is up to 800 VDC. When measuring voltage waveforms by oscilloscope, high voltage differential probes must be used. Failure to do so may result in personal injury or death.</p>
	<p>Warning: The evaluation board contains DC bus capacitors which take time to discharge after removal of the main supply. Failure to do so may result in personal injury or death. Darkened display LEDs are not an indication that capacitors have discharged to safe voltage levels.</p>
	<p>Caution: The heat sink and device surfaces of the evaluation board may become hot during testing. Hence, necessary precautions are required while handling the board. Failure to comply may cause injury.</p>
	<p>Caution: Only personnel familiar with power electronics and associated machinery should plan, install, commission and subsequently service the system. Failure to comply may result in personal injury and/or equipment damage.</p>
	<p>Caution: The evaluation board contains parts and assemblies sensitive to electrostatic discharge (ESD). Electrostatic control precautions are required when installing, testing, servicing or repairing the assembly. Component damage may result if ESD control procedures are not followed. If you are not familiar with electrostatic control procedures, refer to the applicable ESD protection handbooks and guidelines.</p>
	<p>Caution: The evaluation or reference board is shipped with packing materials that need to be removed prior to installation. Failure to remove all packing materials that are unnecessary for system installation may result in overheating or abnormal operating conditions.</p>

Table of contents

About this document	1
Important notice	2
Safety precautions	3
Table of contents	4
1 The board at a glance	5
1.1 Delivery content	5
1.2 Block diagram.....	6
1.3 Main features	6
1.4 Board parameters and technical data	6
2 System and functional description	8
2.1 Commissioning.....	9
2.2 Description of the functional blocks.....	9
2.3 3-pin measurements	10
3 System design	11
3.1 Schematics	11
4 System performance	13
4.1 Test points	13
4.2 Start-up procedure.....	13
5 References and appendices	14
5.1 Abbreviations and definitions.....	14
5.2 References	14
5.3 Additional information.....	14
Revision history	15

1 The board at a glance

The evaluation platform was developed to give users the opportunity to investigate the switching behavior of MOSFETs, IGBTs and their drivers using through-hole and surface mounting. It is an improved version of the existing double-pulse platform [1]. The following improvements were made:

- Through-hole sockets instead of solder points for the device under test (DUT): this allows for an easy replacement of the DUT for repetitive measurements. To reduce the lead inductance, Infineon recommends reducing the leads to a minimum.
- Surface-mount shunt resistor in parallel to coaxial shunt give users the freedom to choose one or the other for their current measurement
- Improved regulation of the negative supply voltage for the driver
- Additional connector X101 as interface from the driver to a microcontroller
- Fixed voltage probe holders for the low-side switch VGS and VDS
- Test points added

Temperature is an additional factor influencing the switching behavior. To investigate this effect, it is possible to mount a heat sink with heating element on the board.

1.1 Delivery content

The scope of supply includes the EVAL-SiC-DP-V2 motherboard packed in a box, including the two drive cards REF-1EDC20I12MHDPV2 and REF-1EDC60H12AHDPV2.

Table1

Product description name	CoolSiC™ MOSFET 1200 V evaluation platform V2	Miller clamp function board for CoolSiC™ MOSFET 1200 V evaluation platform	Bipolar supply function board for CoolSiC™ MOSFET 1200 V evaluation platform
Sales product name	EVAL-PS-DB-MAIN	REF-1EDC20I12MHDPV2	REF-1EDC60H12AHDPV2
OPN	EVALPSDPMAINTOBO1	REF1EDC20I12MHDPV2TOBO1	REF1EDC60H12AHDPV2TOBO1
SP number	SP005572487	SP005613663	SP005613665
Content	<ul style="list-style-type: none"> • Motherboard (CoolSiC™ MOSFET 1200 V evaluation board) – 1 pc • Daughterboard (Miller clamp and bipolar supply boards) – 1 pc each (total 2 pcs) 	<ul style="list-style-type: none"> • Daughterboard (Miller clamp function board) – 1 pc 	<ul style="list-style-type: none"> • Daughterboard (bipolar supply function board) – 1 pc

1.2 Block diagram

Figure 1 shows the block diagram of the motherboard where the core is the half-bridge consisting of S1 and S2. S1 could also be replaced by a diode. The inductor L1 is excluded from the board and is not part of the delivery.

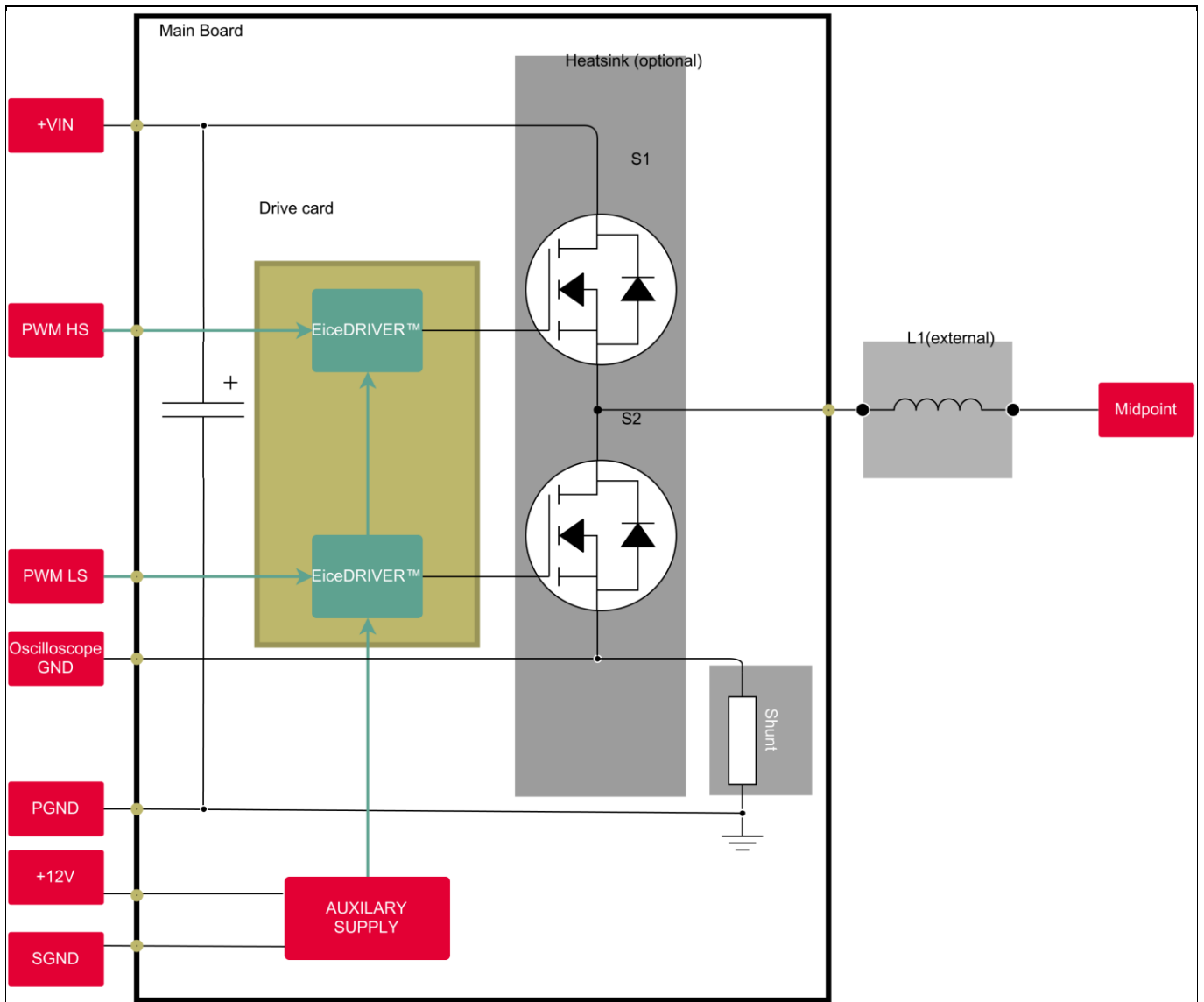

Figure 1 Evaluation platform block diagram

1.3 Main features

- Switching loss calculation
- Easy replacement of the DUT as well as the daughterboards on their connectors
- Fixed probe holders for low-side, gate-source and drain-source voltage measurements
- DC bus up to 800 V tested

1.4 Board parameters and technical data

Main technical data related to the motherboard

The board at a glance

Table 2 **Parameter**

Parameter	Symbol	Conditions	Value	Unit
High voltage input	+VIN		800	V
Auxiliary supply voltage	+12 V		12	V
Maximum pulsed current	I_{max}		130	A
Mechanical dimensions	length		180	mm
	width		100	mm

2 System and functional description

The following chapter gives a functional explanation of the board shown in Figure 2 and Figure 3. The board is split into a primary and secondary section indicated on the board silkscreen. The primary section contains the auxiliary and logic part, and the secondary section the “power” part. Figure 3 shows the jumper settings for the drive voltages and the signal names for a 3-pin and 4-pin configuration. Beside the fixed voltage probe holders, SMD test points are available, from where the corresponding signals can be accessed. For the high-side voltage measurements, differential probes are mandatory.

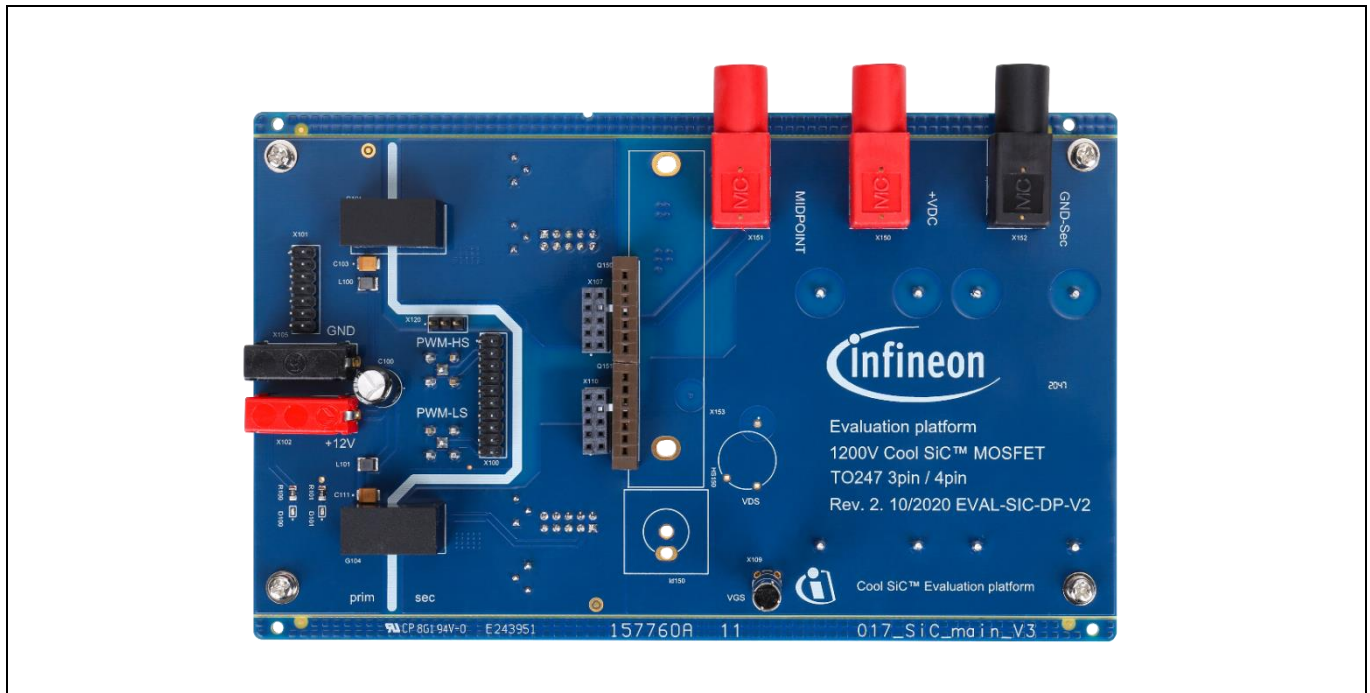

Figure 2 Evaluation platform top view

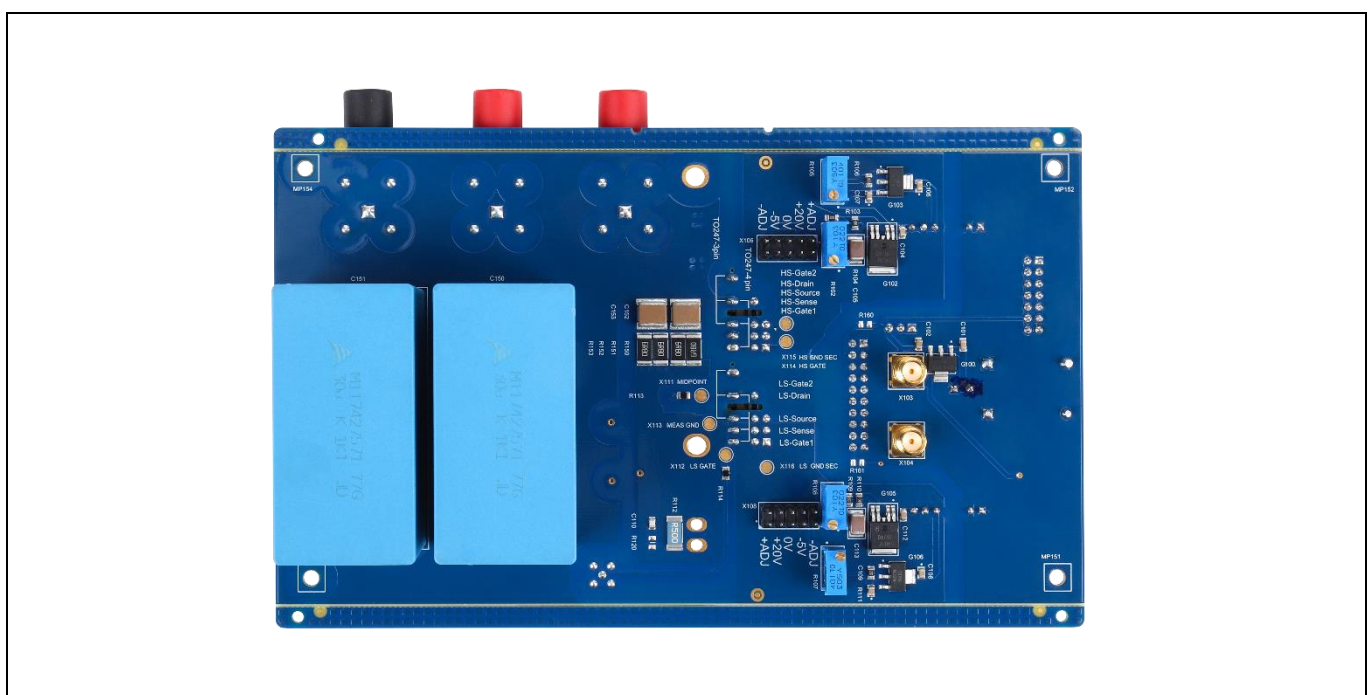

Figure 3 Evaluation platform bottom view

2.1 Commissioning

Connect your DC source to +VDC and GND-Sec. The inductor is plugged into the midpoint and to either the +VDC or GND-Sec, depending on the test to be used, as displayed in Figure 4. The left picture shows the routing for high-side DUT or low-side diode testing, and the right picture shows the opposite.

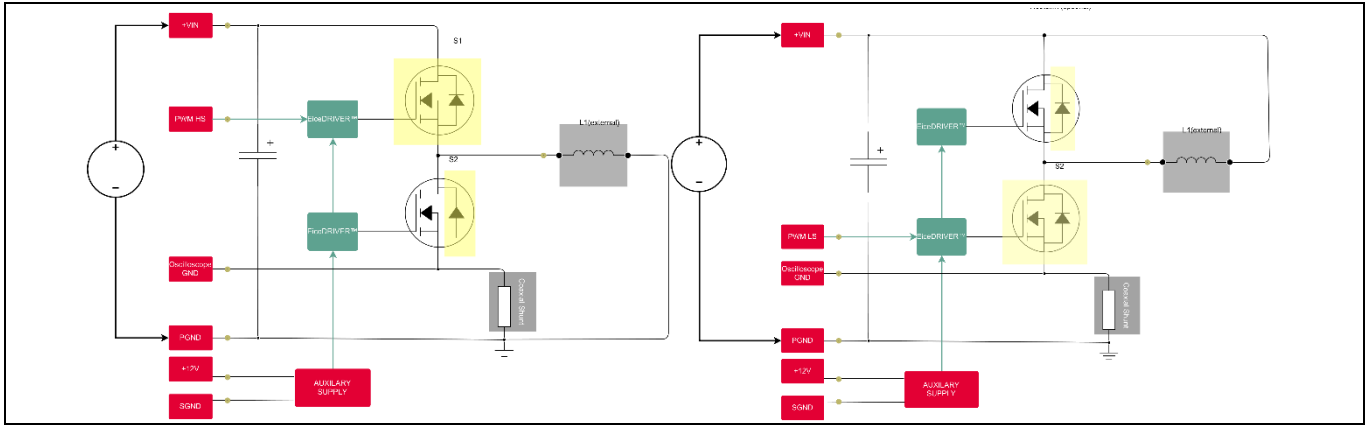

Figure 4 Test configurations

2.2 Description of the functional blocks

Figure 2 shows on the left side the +12V connectors for the auxiliary supply consuming on average 100 mA. Its functionality is indicated with the two LEDs D100 for +12 V and D101 for +5 V, which must be connected by setting a jumper on X120 to the drive card bridging 2 and 3 in Figure 5. The other possibility would be to bridge 1 and 2 for supplying the driver via the μ Controller.

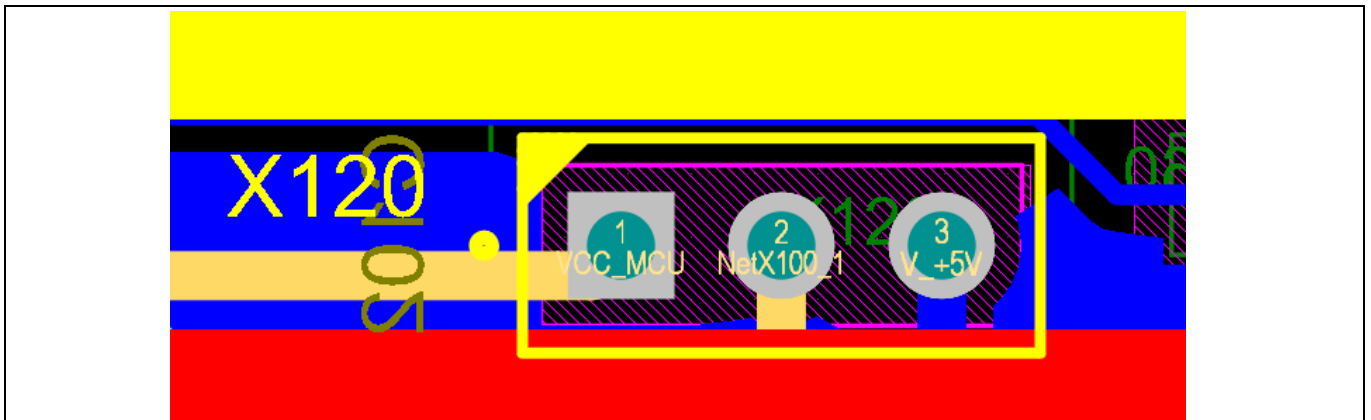

Figure 5 X120 jumper settings

X106 and X108 in Figure 6 are for setting the correct drive voltage on the daughter cards, ranging from +20 V to -5 V; Table 2 visualizes the possible combinations. +ADJ and -ADJ are set via the blue potentiometers R102, 105, 107 and 108.

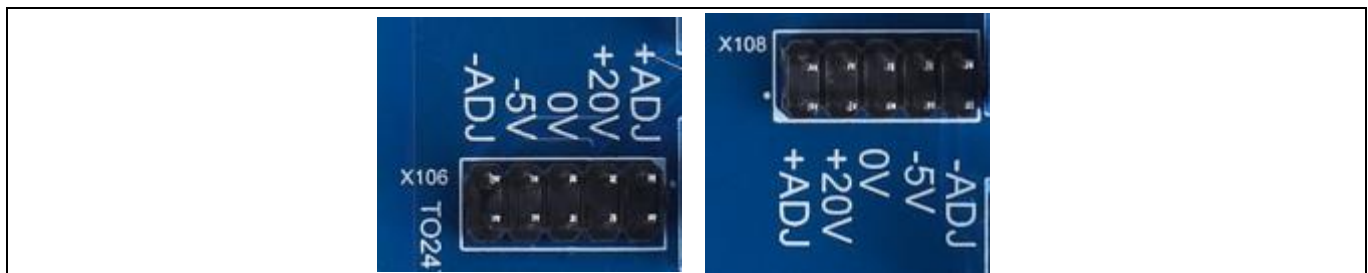

Figure 6 Drive voltage jumpers

Table 2 Possible jumper combinations

+ADJ	+20 V	0 V	-5 V	-ADJ
X		X		
X			X	
X				X
	X	X		
	X		X	
	X			X

The PWM comes either from the coaxial connectors X103, 104 or from the microcontroller via X101.

2.3 3-pin measurements

For 3-pin devices, the source and sense pins must be shorted via a solder bridge on the power connector, as indicated in Figure 7.

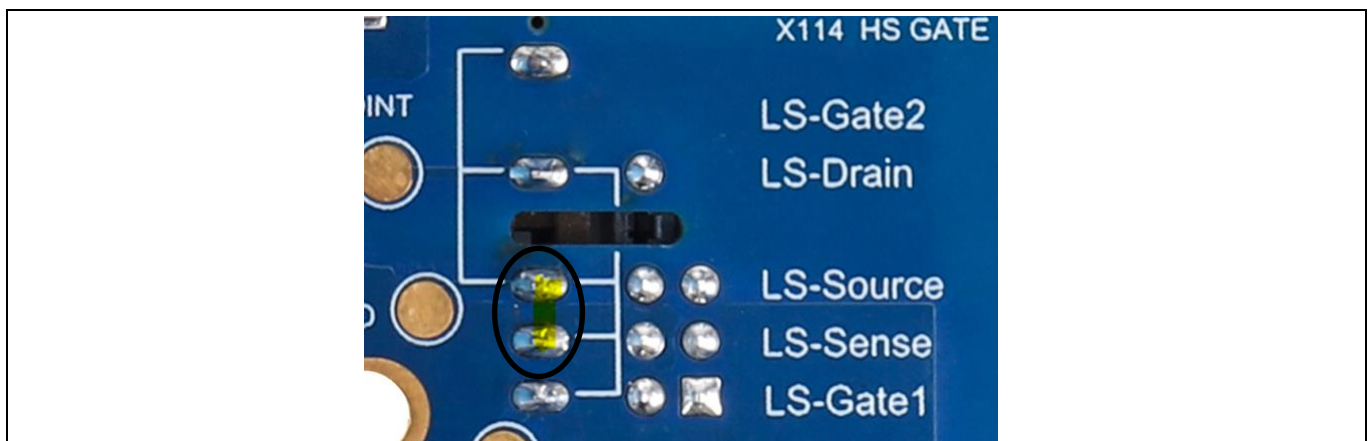

Figure 7 Bottom view power connector

3 System design

The complete design package is available on the download section of the Infineon homepage. A log-in is required to download this material.

3.1 Schematics

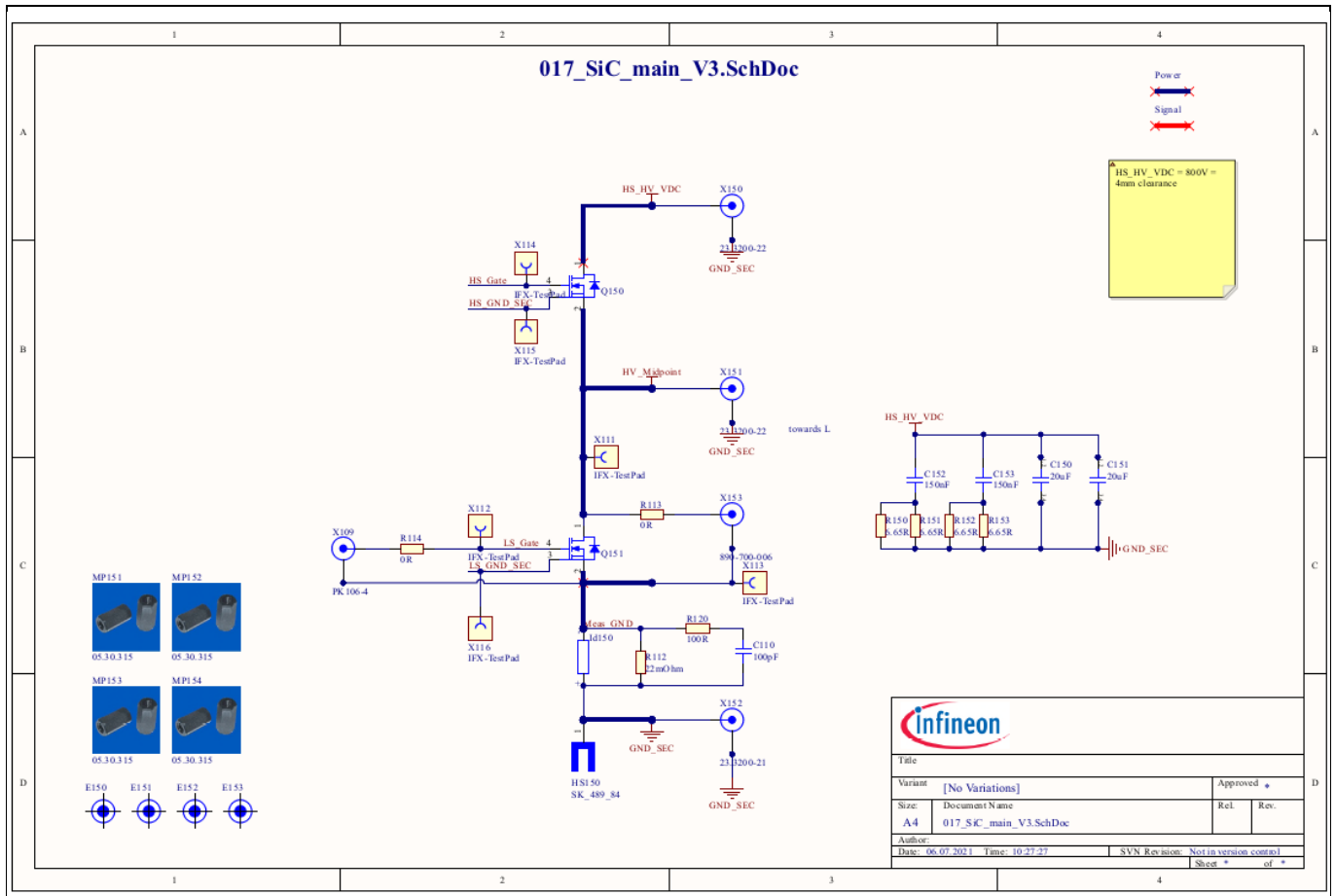

Figure 8 Power circuit schematic diagram

4 System performance

The double-pulse principle is described in [1] in detail. One question that often arises is "What is the correct value for the inductor?" This is also described in [3]. Before powering the board, calculate if the shunt value is sufficient for the current through the DUT.

4.1 Test points

Choose the correct voltage-probe rating for the test point, and keep the ground loops as small as possible.

X111: Midpoint: half-bridge midpoint – high voltage

X112: LS GATE: low-side gate

X113: MEAS GND: measurement ground

X114: HS GATE: high-side gate, requires high-voltage differential probe

X115: HS GND SEC: high-side ground secondary, requires high-voltage differential probe

X116: LS GND SEC: low-side ground secondary

4.2 Start-up procedure

1. Mount drive card on motherboard, and set jumpers to the required supply voltage
2. Plug the DUTs into the connectors Q150, 151
3. Connect power source (VDC up to 800 V), auxiliary supply 12 V, function generator (for double pulse); setting current limits for safety reasons is recommended
4. Connect the load inductor, either HS or LS
5. Plug in the desired probes (voltage, current)
6. Turn-on procedure: A) Apply 12 V and double pulse; B) Apply high voltage gradually until desired level; C) Do measurements
7. Turn-off procedure: A) Switch off the high-voltage source; B) switch off Aux supply and function generator

5 References and appendices

5.1 Abbreviations and definitions

Table 3 Abbreviations

Abbreviation	Meaning
DUT	Device under test
PWM	Pulse width modulation
UL	Underwriters' Laboratories

5.2 References

- [1] Infineon Technologies AG. AN2019-28 (2019): 1200 V CoolSiC™ MOSFET in TO-247 3-/4-pin evaluation platform. V1.0 www.infineon.com
- [2] Infineon Technologies AG. UG-2021-17 (2021): EVAL-1ED020I12F2-DB user guide. Isolated driver daughter board to evaluate 1200 V CoolSiC™. V1.0 www.infineon.com
- [3] D. Levett, Z. Zheng, T. Frank, Double Pulse Testing: The How, What and Why, Bodo's Power Systems 2020, p. 30-35

5.3 Additional information

The isolated gate driver daughter card EVAL-1ED020I12F2-DB is designed to be used with this motherboard and can be ordered separately.



Revision history

Revision history

Document version	Date of release	Description of changes
Rev 1.0	2021-08-20	First release

Trademarks

All referenced product or service names and trademarks are the property of their respective owners.

Edition 2021-08-01

Published by

Infineon Technologies AG

81726 Munich, Germany

© 2021 Infineon Technologies AG.

All Rights Reserved.

Do you have a question about this document?

Email: erratum@infineon.com

Document reference

UG-2021-32

For further information on the product, technology, delivery terms and conditions and prices please contact your nearest Infineon Technologies office (www.infineon.com).

WARNINGS

Due to technical requirements products may contain dangerous substances. For information on the types in question please contact your nearest Infineon Technologies office.

Except as otherwise explicitly approved by Infineon Technologies in a written document signed by authorized representatives of Infineon Technologies, Infineon Technologies' products may not be used in any applications where a failure of the product or any consequences of the use thereof can reasonably be expected to result in personal injury.