

GAAS MMIC SP8T NON-REFLECTIVE SWITCH, DC - 2.5 GHz

Typical Applications

The HMC253AQS24 / HMC253AQS24E is ideal for DC - 2.5 GHz applications:

- CATV/DBS
- CDMA
- Cellular/PCS

Features

- Low Insertion Loss (2 GHz): 1.1dB
- Single Positive Supply: $V_{dd} = +5V$
- Integrated 3:8 TTL Decoder
- 24 Lead QSOP Package

Functional Diagram

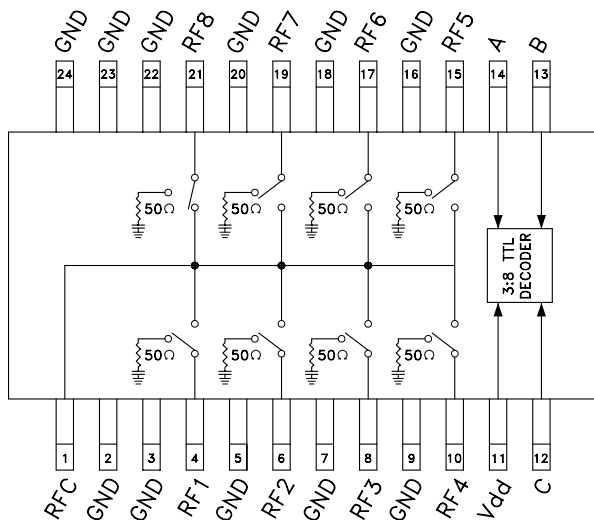

General Description

The HMC253AQS24 & HMC253AQS24E are low-cost non-reflective SP8T switches in 24-lead QSOP packages featuring wideband operation from DC to 2.5 GHz. The switch offers a single positive bias and true TTL/CMOS compatibility. A 3:8 decoder is integrated on the switch requiring only 3 control lines and a positive bias to select each path. The HMC253AQS24 & HMC253AQS24E SP8T will replace multiple configurations of SP4T and SPDT MMIC switches.

Electrical Specifications,

$T_A = +25^\circ C$, For TTL Control and $V_{dd} = +5V$ in a 50 Ohm system

Parameter	Frequency	Min.	Typ.	Max.	Units
Insertion Loss	DC - 1.0 GHz		1.0	1.5	dB
	DC - 2.0 GHz		1.1	1.7	dB
	DC - 2.5 GHz		1.4	2.1	dB
Isolation	DC - 1.0 GHz	35	40		dB
	DC - 2.0 GHz	30	35		dB
	DC - 2.5 GHz	28	33		dB
Return Loss	"On State"	DC - 1.0 GHz		21	dB
		DC - 2.0 GHz		20	dB
		DC - 2.5 GHz		16	dB
Return Loss (RF1-8)	"Off State"	0.3 - 2.5 GHz		8	dB
		0.5 - 2.5 GHz		13	dB
Input Power for 1 dB Compression	0.3 - 2.5 GHz	20	23		dBm
Input Third Order Intercept (Two-Tone Input Power = +10 dBm Each Tone)	0.3 - 2.5 GHz	41	46		dBm
Switching Characteristics	0.3 - 2.5 GHz				
tRISE, tFALL (10/90% RF)			20		ns
tON, tOFF (50% CTL to 10/90% RF)			90		ns

GAAS MMIC SP8T NON-REFLECTIVE SWITCH, DC - 2.5 GHz

Insertion Loss

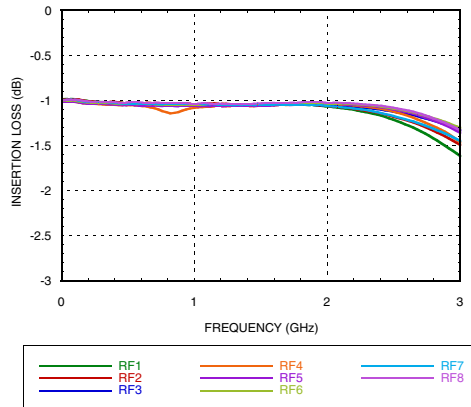

Insertion Loss vs. Temperature

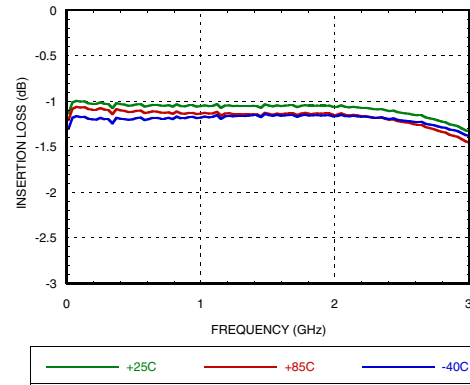

Return Loss

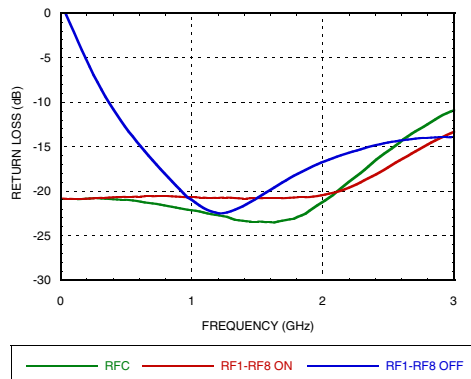

Isolation

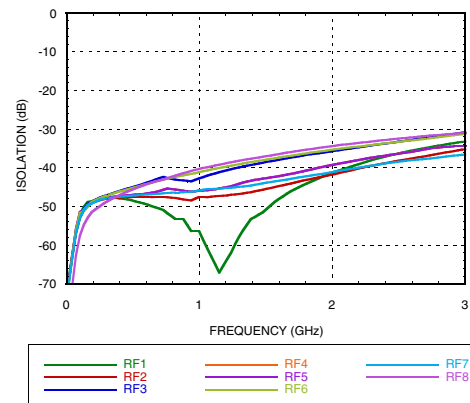

Input IP3

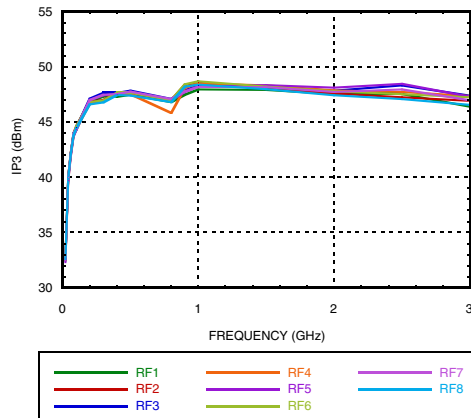

Input Compression

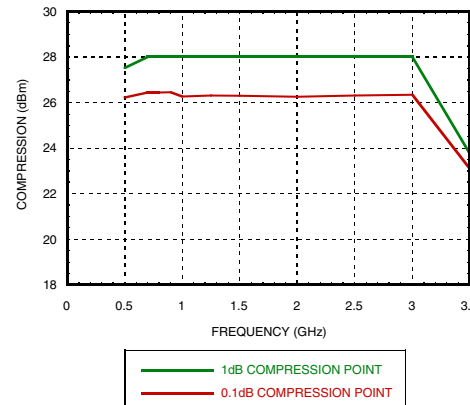

Information furnished by Analog Devices is believed to be accurate and reliable. However, no responsibility is assumed by Analog Devices for its use, nor for any infringements of patents or other rights of third parties that may result from its use. Specifications subject to change without notice. No license is granted by implication or otherwise under any patent or patent rights of Analog Devices. Trademarks and registered trademarks are the property of their respective owners.

For price, delivery, and to place orders: Analog Devices, Inc., One Technology Way, P.O. Box 9106, Norwood, MA 02062-9106 Phone: 781-329-4700 • Order online at www.analog.com Application Support: Phone: 1-800-ANALOG-D

**GAAS MMIC SP8T NON-REFLECTIVE
SWITCH, DC - 2.5 GHz**
Bias Voltage & Current

Vdd Range = +5 Vdc ± 10%		
Vdd (Vdc)	Idd (Typ.) (mA)	Idd (Max.) (mA)
+5	4.5	7.5

TTL/CMOS Control Voltages

State	Bias Condition
Low	0 to +0.8 Vdc @ <1 μA Typ.
High	+2.0 to +5 Vdc @ 60 μA Typ.

Truth Table

Control Input			Signal Path State
A	B	C	RFCOM to:
Low	Low	Low	RF1
High	Low	Low	RF2
Low	High	Low	RF3
High	High	Low	RF4
Low	Low	High	RF5
High	Low	High	RF6
Low	High	High	RF7
High	High	High	RF8

NOTE:

DC Blocking capacitors are required at ports RFC and RF1, 2, 3, 4, 5, 6, 7, 8.

**ELECTROSTATIC SENSITIVE DEVICE
OBSERVE HANDLING PRECAUTIONS**
Absolute Maximum Ratings

Bias Voltage Range (Port Vdd)	+7.0 Vdc
Control Voltage Range (A, B, C)	-0.5V to Vdd +1Vdc
Channel Temperature	150 °C
Thermal Resistance (channel to package ground paddle)	Through Path 183 °C/W Termination Path 274 °C/W
Storage Temperature	-65 to +150 °C
Operating Temperature	-40 to +85 °C
Maximum Input Power (Vdd = +5V)	Through Path +20 dBm (0.05 - 0.5 GHz) +25 dBm (0.5 - 2.5 GHz) Terminated Path +20 dBm (0.05 - 0.5 GHz) +23.5 dBm (0.5 - 2.5 GHz)
ESD Sensitivity (HBM)	Class 1A

GAAS MMIC SP8T NON-REFLECTIVE SWITCH, DC - 2.5 GHz

Outline Drawing

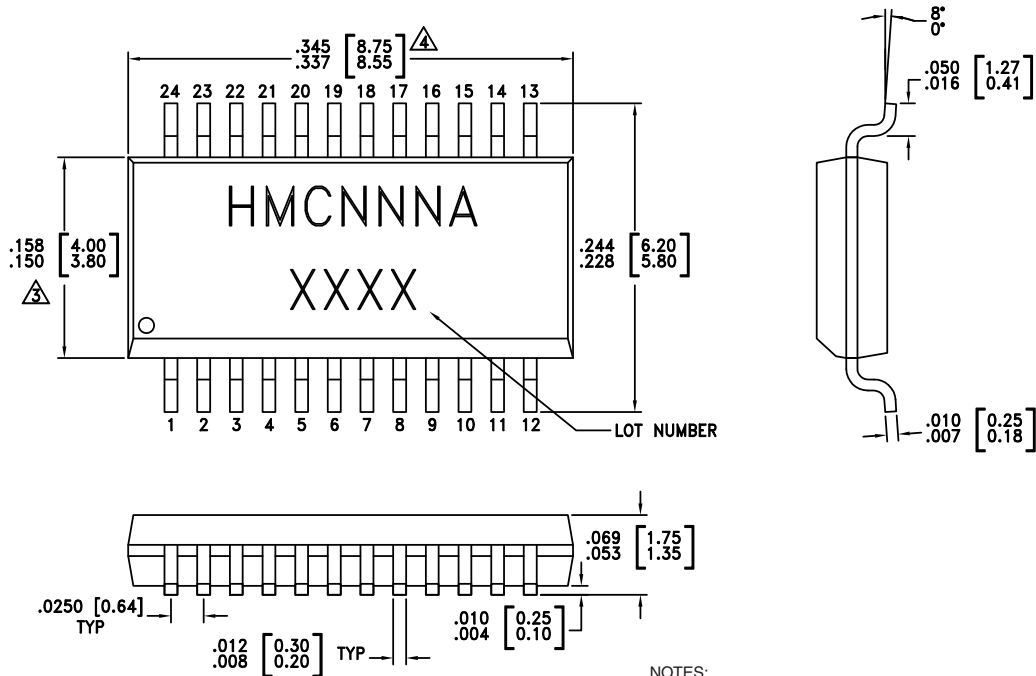

NOTES:

1. LEADFRAME MATERIAL: COPPER ALLOY
2. DIMENSIONS ARE IN INCHES [MILLIMETERS].
- △ DIMENSION DOES NOT INCLUDE MOLDFLASH OF 0.15mm PER SIDE.
- △ DIMENSION DOES NOT INCLUDE MOLDFLASH OF 0.25mm PER SIDE.
5. ALL GROUND LEADS MUST BE SOLDERED TO PCB RF GROUND.

Package Information

Part Number	Package Body Material	Leadframe Plating	MSL Rating	Package Marking ^[3]
HMC253AQS24	Low Stress Injection Molding Plastic Silica and Silicon Impregnated	Sn/Pb Solder	MSL1 ^[1]	HMC253A XXXX
HMC253AQS24E	RoHS-compliant Low Stress Injection Molding Plastic Silica and Silicon Impregnated	100% Matte Tin	MSL1 ^[2]	HMC253A XXXX

[1] Max peak reflow temperature of 235 °C

[2] Max peak reflow temperature of 260 °C

[3] 4-Digit lot number XXXX

GAAS MMIC SP8T NON-REFLECTIVE SWITCH, DC - 2.5 GHz

Evaluation Circuit Board

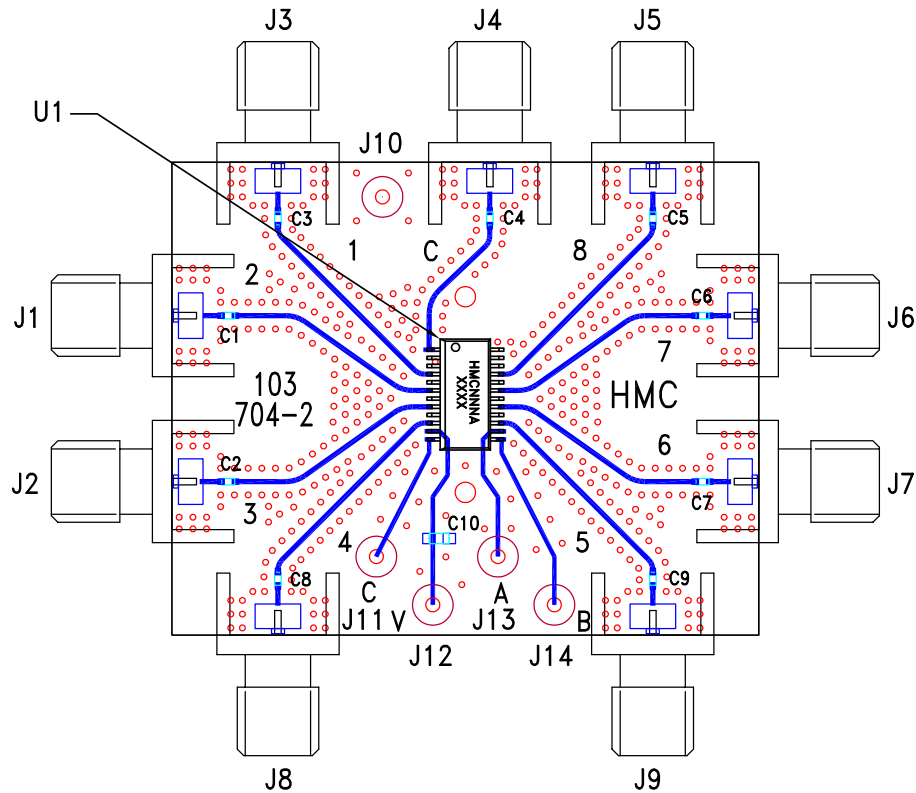

List of Materials for Evaluation PCB EV1HMC253AQS24^[1]

Item	Description
J1 - J9	PCB Mount SMA Connector
J10 - J14	DC Pin
C1 - C9	100 pF Capacitor, 0402 Pkg.
C10	0.01 uF Capacitor, 0603 Pkg.
U1	HMC253AQS24 / HMC253AQS24E SP8T Switch
PCB [2]	103704 Eval Board

[1] Reference this number when ordering complete evaluation PCB

[2] Circuit Board Material: Rogers 4350

The circuit board used in the application should be generated with proper RF circuit design techniques. Signal lines at the RF ports should have 50 ohm impedance while the package ground leads should be connected directly to the ground plane similar to that shown above. A sufficient number of via holes should be used to connect the top and bottom ground planes. The evaluation circuit board shown above is available from Analog Devices upon request.