

Ansaughaube  
hood

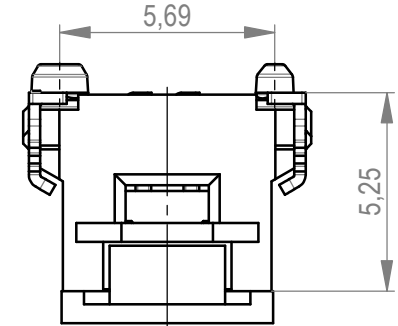

Leiterplatten-Layout für SMT  
PCB-Layout for SMT

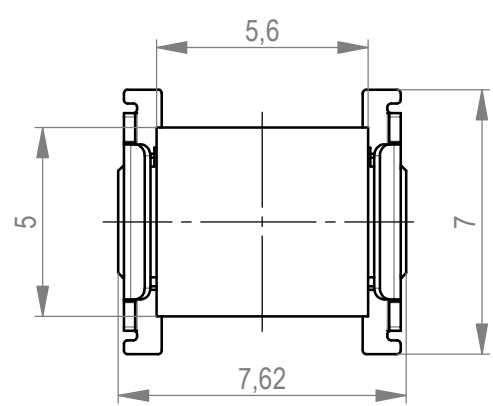
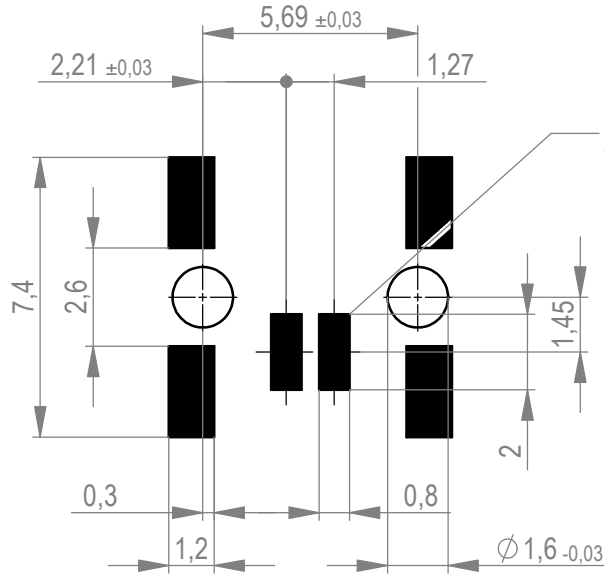

Kontaktbezeichnung bei Pin 1  
contact marking at pin 1

ohne Ansaughaube - without hood

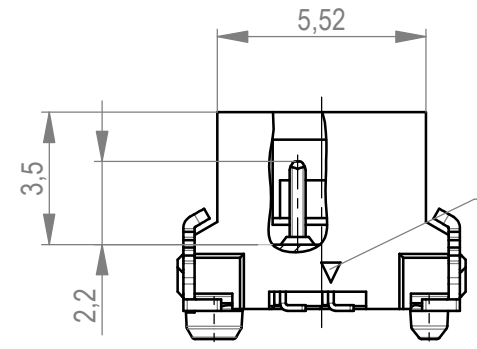

Kontaktbezeichnung  
contact marking

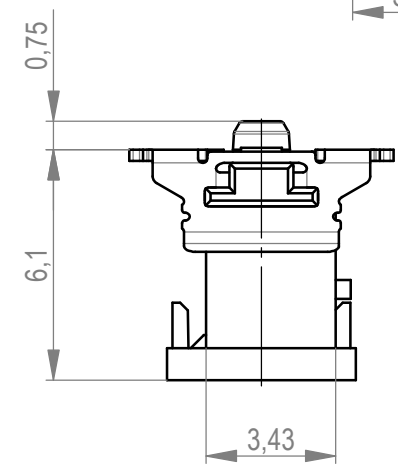
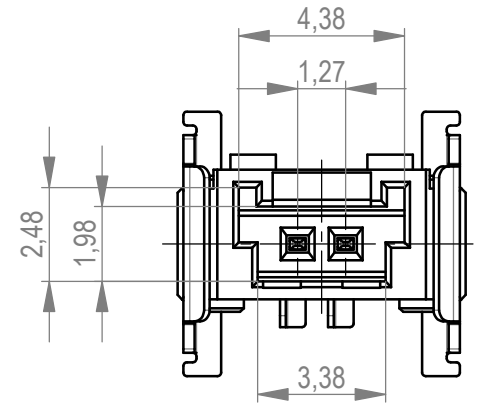

Verpackt im Gurt in Anlehnung an DIN IEC 60286-3  
tape on reel packaging according to DIN IEC 60286-3  
Verpackungseinheit: 650 Stück  
packaging unit: 650 pcs

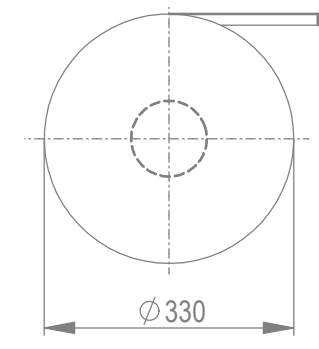

Abspulrichtung - reel off direction

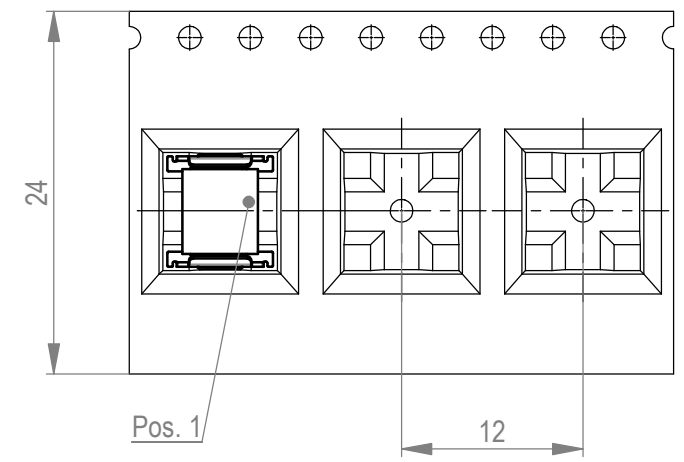

Anforderungsstufe 1  
performance level 1

Kontaktbereich vergoldet  
mating area gold plating

Anschlussbereich verzinkt 4-6 µm  
terminal area 4-6 µm tin plating

Koplanarität der Anschlüsse ≤ 0,1 mm  
coplanarity area of termination ≤ 0,1 mm

\*Für die Anforderung nach PG 9 der LV214  
(Koshiri-Sicherheit)  
\*For the requirement of the LV214 PG 9  
(Koshiri-security)

Dimension no.	Tolerances Dim. for Information ISO 8015	All Dimensions in mm	Scale 5:1	Material
Customer drawing: All rights reserved. Only for Information. To ensure that this is the latest version of this drawing, please contact one of the ERNI companies before using.	Subject to modification without prior notice. Drawing will not be updated.		MiniBridge Male Straight SMT 02p KS*	
b	01.03.2021		ERNI International AG Zürichstrasse 72 8306 Brüttisellen - Zürich Switzerland	474125
Index	Date		Class SRCP	I A3

Weitergabe sowie Vervielfältigung dieses Dokuments, Verwertung und Mitteilung seines Inhalts sind verboten, soweit nicht ausdrücklich gestattet. Zuwiderhandlungen verpflichten zu Schadenersatz. Alle Rechte für den Fall der Patent-, Gebrauchsmuster- oder Geschmacksmusterertragung vorbehalten. The reproduction, distribution and utilization of this document as well as the communication of its contents to others without express authorization is prohibited. Offenders will be held liable for the payment of damages. All rights reserved in the event of the grant of a patent, utility model or design.

Die deutsche Version dieser Zeichnung dient nur zur Erleichterung der Handhabung. Bei Abweichungen von dem englischen Original gilt das englische Original. The german version of this drawing has been offered for convenience only and may deviate from the english original. In case of any deviation the English version shall prevail.