



APPLICATION SPECIFICATION

RECTANGULAR STANDARD NFC ANTENNA

1.0 SCOPE

This specification describes the antenna application and surroundings. The information in this document is for reference and benchmark purposes only. The user is responsible for verifying antenna RF performance based on the user's actual implementation.

Antenna illustrations in this document are generic representations. They are not intended to be an image of any antenna listed in the scope.

2.0 PRODUCT DESCRIPTION

The 146236 series is a rectangular and flexible antenna for Near Field Communication (NFC) application. There are four kinds of flex size in this series and for each flex size there are two versions depending on with ferrite or without ferrite.

A. DEFINITIONS OF TERMS

Figure 1 shows the overall antenna size is L (mm) *W (mm)

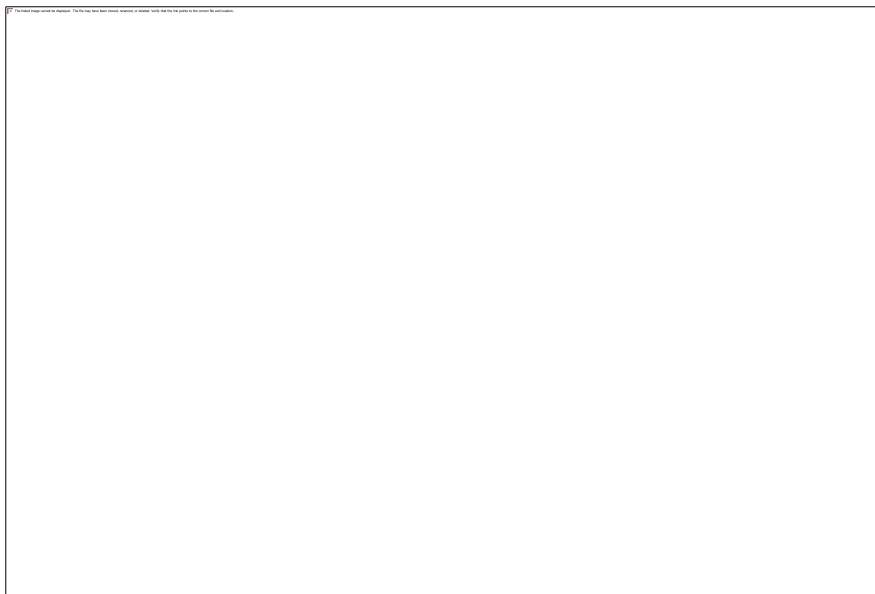

FIGURE1. DIMENSION OF THE RECTANGULAR STANDARD NFC ANTENNA

REVISION: A1	ECR/ECN INFORMATION: EC No: 119740 DATE: 2017/02/09	TITLE: Rectangular Standard NFC Antenna Application Specification	SHEET No. 1 of 10
DOCUMENT NUMBER: AS-146236-001		CREATED / REVISED BY: Benson Liu 2017/02/09	CHECKED BY: Ryan Liu 2017/02/09
		APPROVED BY: Welson Tan 2017/02/09	



APPLICATION SPECIFICATION

B. SPECIFICATIONS OF THE RECTANGULAR STANDARD NFC ANTENNA

Part No.	1462360001	1462360011	1462360021	1462360031
Name	Rectangular Standard NFC Antenna 15X25	Rectangular Standard NFC Antenna 23X27	Rectangular Standard NFC Antenna 34X46	Rectangular Standard NFC Antenna 45X55
Size	15mm*25mm	23mm*27mm	34mm*46mm	45mm*55mm
Material	Flex	Flex	Flex	Flex
Antenna Type	Near-field coupling	Near-field coupling	Near-field coupling	Near-field coupling
Frequency Range	13.56MHz	13.56MHz	13.56MHz	13.56MHz
Inductor @ 13.56MHz	2.11uH	2.09uH	2.76uH	2.59uH
Part No.	1462360101	1462360111	1462360121	1462360131
Name	Rectangular Standard NFC Antenna 15X25 (With Ferrite)	Rectangular Standard NFC Antenna 23X27 (With Ferrite)	Rectangular Standard NFC Antenna 34X46 (With Ferrite)	Rectangular Standard NFC Antenna 45X55 (With Ferrite)
Size	15mm*25mm	23mm*27mm	34mm*46mm	45mm*55mm
Material	Flex with Ferrite	Flex with Ferrite	Flex with Ferrite	Flex with Ferrite
Antenna Type	Near-field coupling	Near-field coupling	Near-field coupling	Near-field coupling
Frequency Range	13.56MHz	13.56MHz	13.56MHz	13.56MHz
Inductor @ 13.56MHz	3.32uH	3.22uH	4.25uH	3.92uH

TABLE1. SPECIFICATIONS OF THE RECTANGULAR STANDARD NFC ANTENNA

3.0 REFERENCE DOCUMENTS

- SALES DRAWING – SD-146236-001
- PRODUCT SPECIFICATION – PS-146236-001
- PACKAGING INFORMATION – REFER TO THE MOLEX RELATED PACKAGING DRAWINGS.

4.0 DETECTION DISTANCE TEST

4.1 Test system for NFC antenna in Free Space

To compare the NFC antenna performance, we design a test system to simulate the usage of the NFC antenna and measure the maximum detection distance. One thing should be mentioned here, this test system is

REVISION: A1	ECR/ECN INFORMATION: EC No: 119740 DATE: 2017/02/09	TITLE: Rectangular Standard NFC Antenna Application Specification	SHEET No. 2 of 10
DOCUMENT NUMBER: AS-146236-001	CREATED / REVISED BY: Benson Liu 2017/02/09	CHECKED BY: Ryan Liu 2017/02/09	APPROVED BY: Welson Tan 2017/02/09

different from the NFC forum protocol test system and it is just used for NFC antennas performance comparison.

The below picture shows the test system set up. The NFC antenna is connected to the evaluation board, which is controlled by the computer. In order to get good detection distance, the NFC antennas have been well matched on the evaluation board. The standard RFID tags are placed on plastic part of the fixture, which can be movable. With the help of the ruler, we can get the maximum detection distance between RFID tags and NFC antennas when the distance is tuned and the reader cannot read the RFID tag.

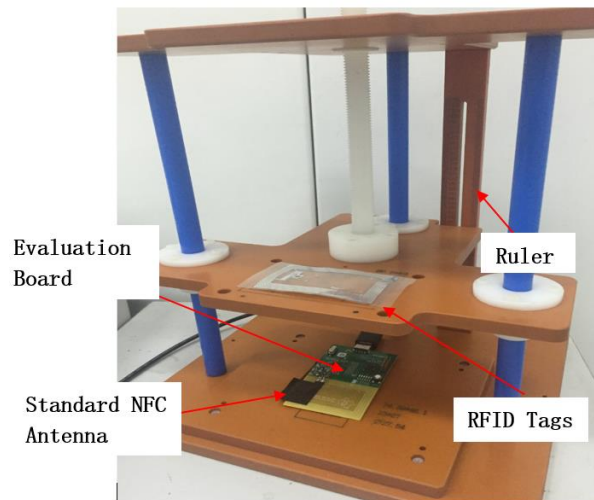

FIGURE2. TEST SYSTEM FOR NFC ANTENNA IN FREE SPACE

The Tag-it HF-I RFID tags from Texas Instruments tags used for measurement are as following: RI-102-112, RI-I03-112 and Button. The below pictures show the different tags.



FIGURE3. THE DIFFERENT RFID TAGS USED FOR MEASUREMENT

Texas Instruments Tag-it HF-I standard transponder inlays consist of 13.56-MHz high- frequency (HF) transponders that are compliant with the ISO/IEC 15693 and ISO/IEC 18000-3 global open standard. The Tag-it HF-I standard transponder inlays available in various inlay shapes also form the basis of consumable smart labels for use in markets requiring quick and accurate identification of items. The passive (no battery) transponder inlays are thin and flexible, offer a general purpose read/write capability, and are designed to be easily converted into paper or plastic labels.

REVISION: A1	ECR/ECN INFORMATION: EC No: 119740 DATE: 2017/02/09	TITLE: Rectangular Standard NFC Antenna Application Specification	SHEET No. 3 of 10
DOCUMENT NUMBER: AS-146236-001	CREATED / REVISED BY: Benson Liu 2017/02/09	CHECKED BY: Ryan Liu 2017/02/09	APPROVED BY: Welson Tan 2017/02/09

4.2 Test Results for NFC antenna in Free Space

The four size rectangular standard NFC antennas are under the detection distance test in free space. The below figures show the detection distance between NFC antennas and the three RFID tags.

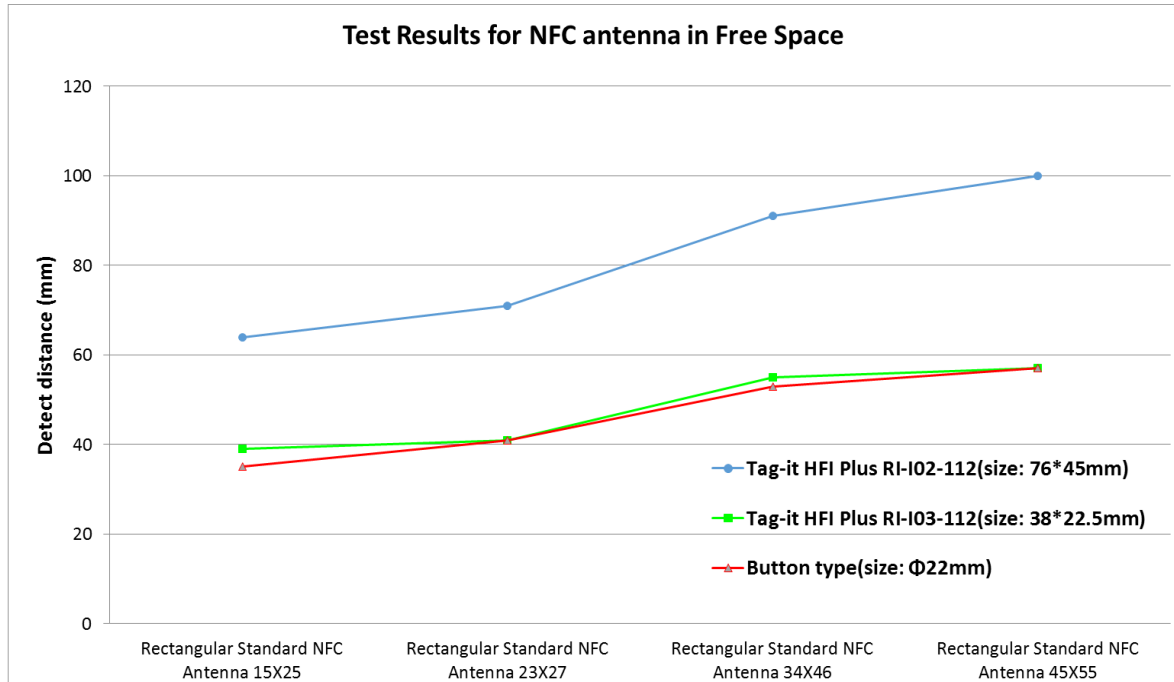

FIGURE4. DETECTION DISTANCE FOR NFC ANTENNA IN FREE SPACE

4.3 Test System for NFC antenna attached near metallic surface

Compared with test results for NFC antenna in free space, the only difference is the metal part, which was simulated by a PCB with copper. We would like to evaluate the influence of the distance between the metallic surface and NFC antenna.

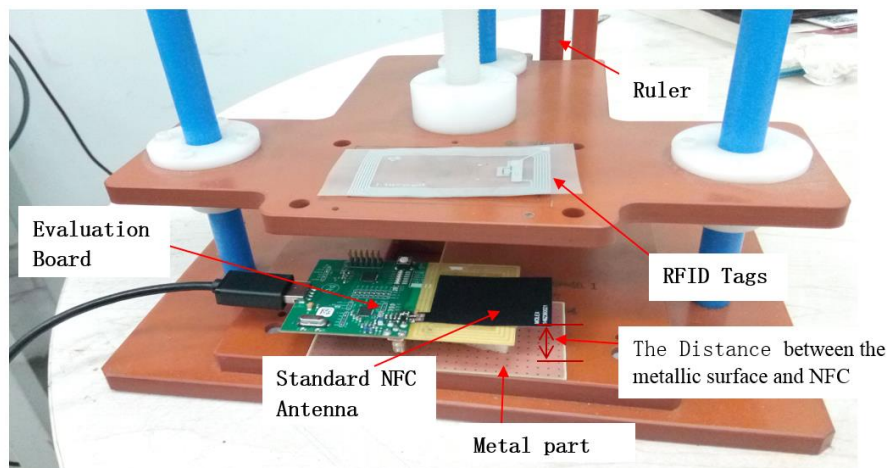

FIGURE5. TEST SYSTEM FOR NFC ANTENNA ATTACHED NEAR METALLIC SURFACE

REVISION: A1	ECR/ECN INFORMATION: EC No: 119740 DATE: 2017/02/09	TITLE: Rectangular Standard NFC Antenna Application Specification	SHEET No. 4 of 10
DOCUMENT NUMBER: AS-146236-001	CREATED / REVISED BY: Benson Liu 2017/02/09	CHECKED BY: Ryan Liu 2017/02/09	APPROVED BY: Welson Tan 2017/02/09

4.4 Test Results for NFC antenna attached near metal

The four size rectangular standard NFC antennas as well as the antennas with Ferrite are under the detection distance test near metallic surface just as below.

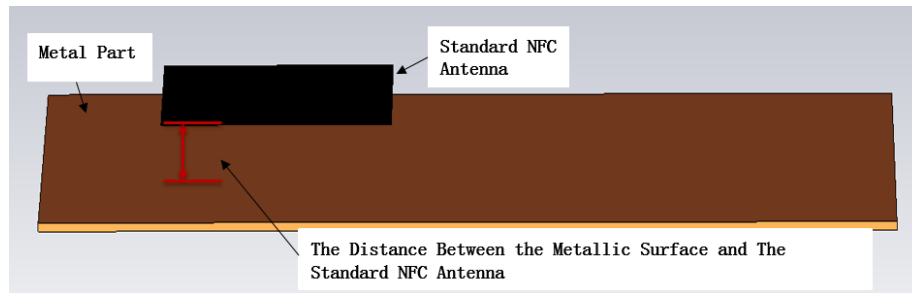

FIGURE6. THE DISTANCE BETWEEN THE METALLIC SURFACE AND THE STANDARD NFC ANTENNA

The below figure7~figure14 show the detection distance between NFC antennas and the three RFID tags in different distances between NFC antenna and metallic surface. The effect of metal is evaluated with 4 different distances from the standard NFC antenna. The 4 distances are as follow: 0mm, 5mm, 15mm and free space (without metal part).

From the Figure 7, Figure 9, Figure 11 and Figure 13 we can get that the NFC antennas without ferrite cannot work if they are mounted on the metallic surface directly. When the distance between NFC antenna and metallic surface is over 15mm, the detection distance between NFC antennas and RFID tags is close to the NFC antenna detection distance in free space.

From the Figure 8, Figure 10, Figure 12 and Figure 14 we can get that the NFC antennas with ferrite can work if they are mounted on the metallic surface directly. When the distance between NFC antenna and metallic surface is over 15mm, the detection distance between NFC antennas and RFID tags is close to the NFC antenna with ferrite detection distance in free space.

From the Figure 7~Figure 14 we can get that the distance between NFC antenna and metallic surface is shorter than 15mm, the NFC antenna with ferrite performance is much better than the same size NFC antenna without ferrite. So we recommend to use the NFC antenna with ferrite in this situation. When the distance between NFC antenna and metallic surface is over than 15mm, the NFC antenna with ferrite is similar with the same size NFC antenna without ferrite. So we recommend to use the NFC antenna without ferrite in this situation.

<u>REVISION:</u>	<u>ECR/ECN INFORMATION:</u>	<u>TITLE:</u>		<u>SHEET No.</u>
A1	EC No: 119740 DATE: 2017/02/09	Rectangular Standard NFC Antenna Application Specification		5 of 10
<u>DOCUMENT NUMBER:</u>		<u>CREATED / REVISED BY:</u>	<u>CHECKED BY:</u>	<u>APPROVED BY:</u>
AS-146236-001		Benson Liu 2017/02/09	Ryan Liu 2017/02/09	Welson Tan 2017/02/09



APPLICATION SPECIFICATION

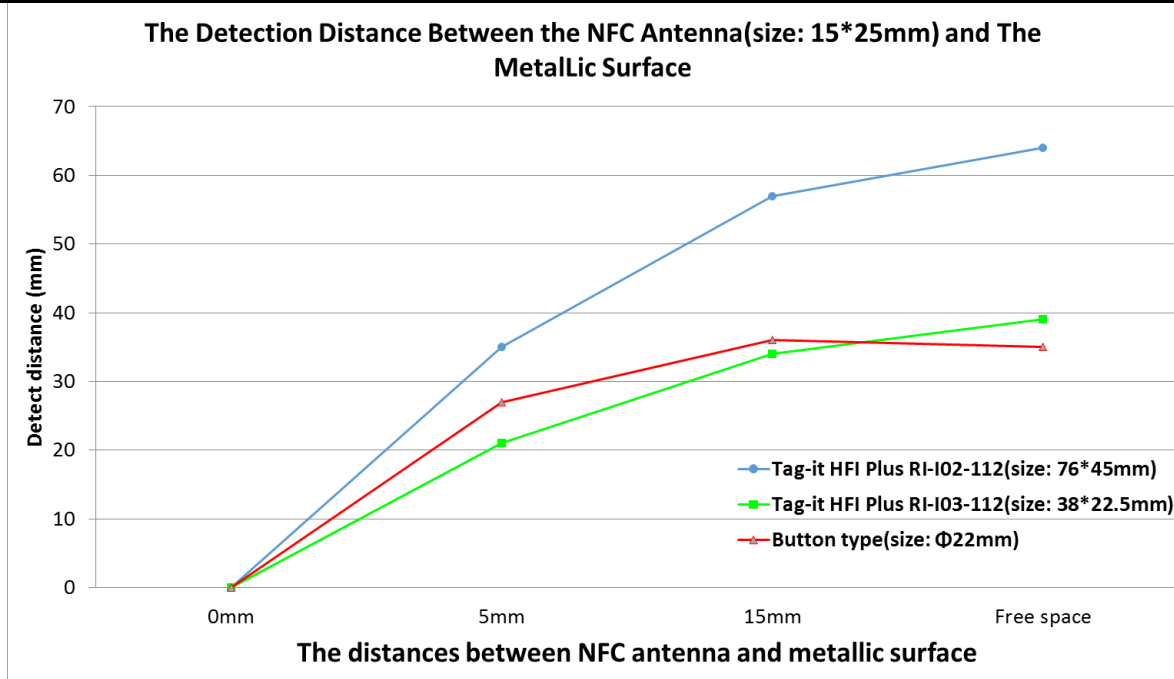

FIGURE7. DETECTION DISTANCE FOR NFC ANTENNA 15*25MM

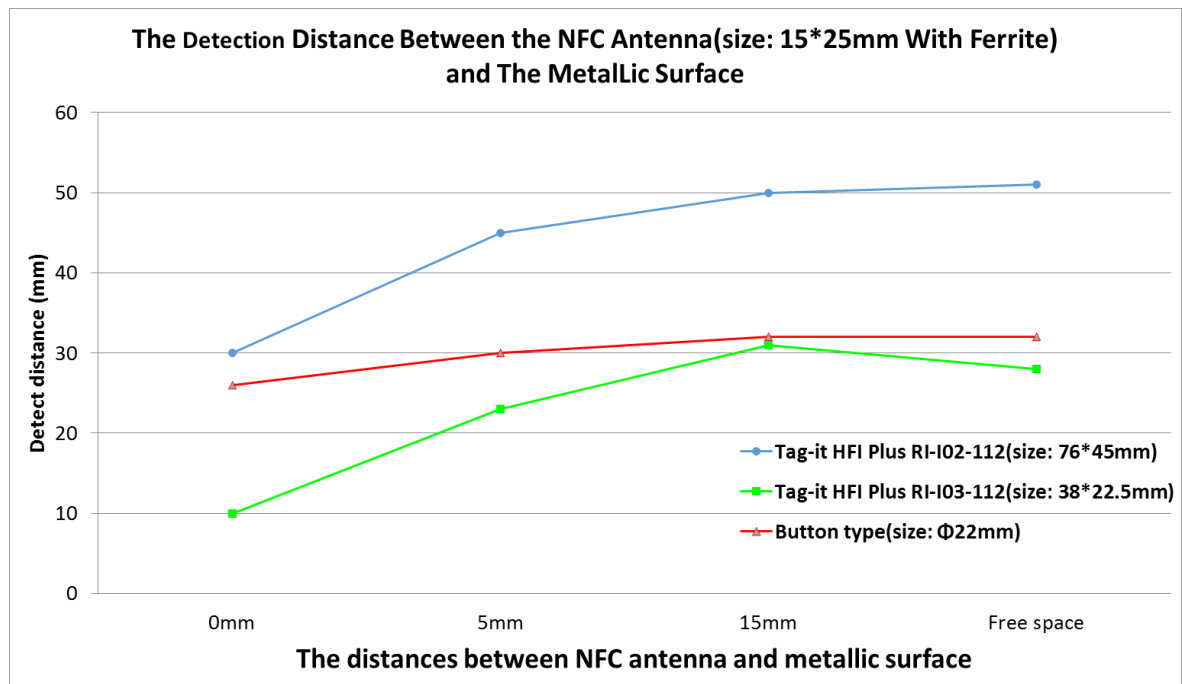

FIGURE8. DETECTION DISTANCE FOR NFC ANTENNA 15*25MM (WITH FERRITE)

REVISION: A1	ECR/ECN INFORMATION: EC No: 119740 DATE: 2017/02/09	TITLE: Rectangular Standard NFC Antenna Application Specification	SHEET No. 6 of 10
DOCUMENT NUMBER: AS-146236-001	CREATED / REVISED BY: Benson Liu 2017/02/09	CHECKED BY: Ryan Liu 2017/02/09	APPROVED BY: Welson Tan 2017/02/09



APPLICATION SPECIFICATION

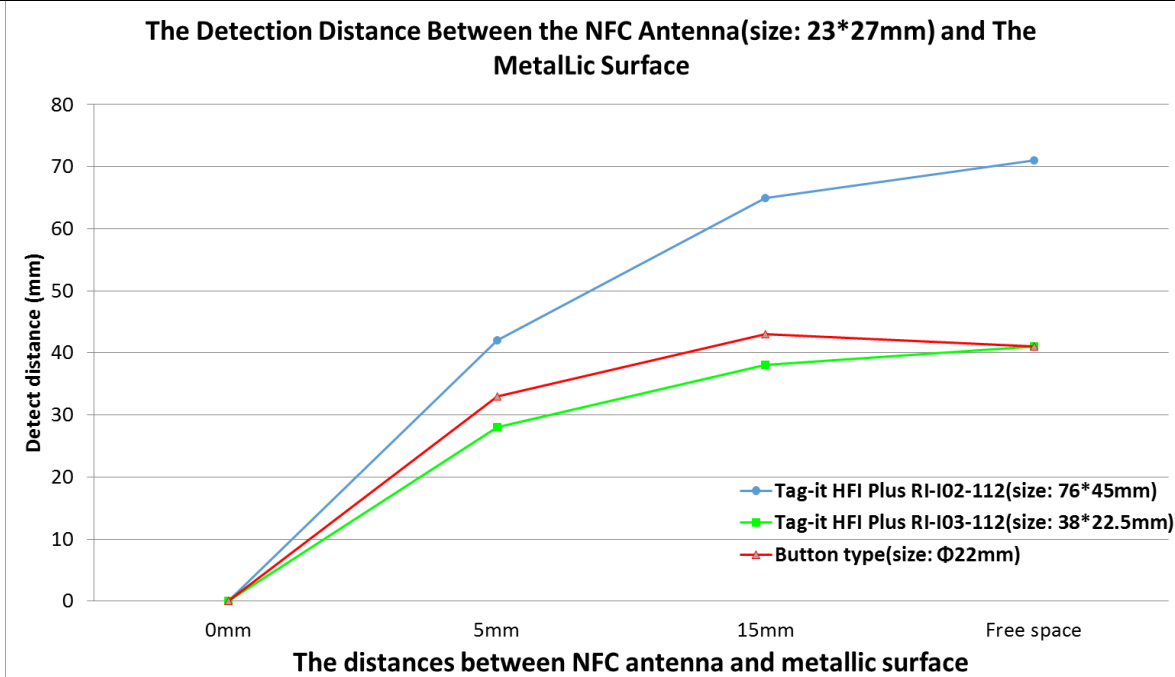

FIGURE9. DETECTION DISTANCE FOR NFC ANTENNA 23*27MM

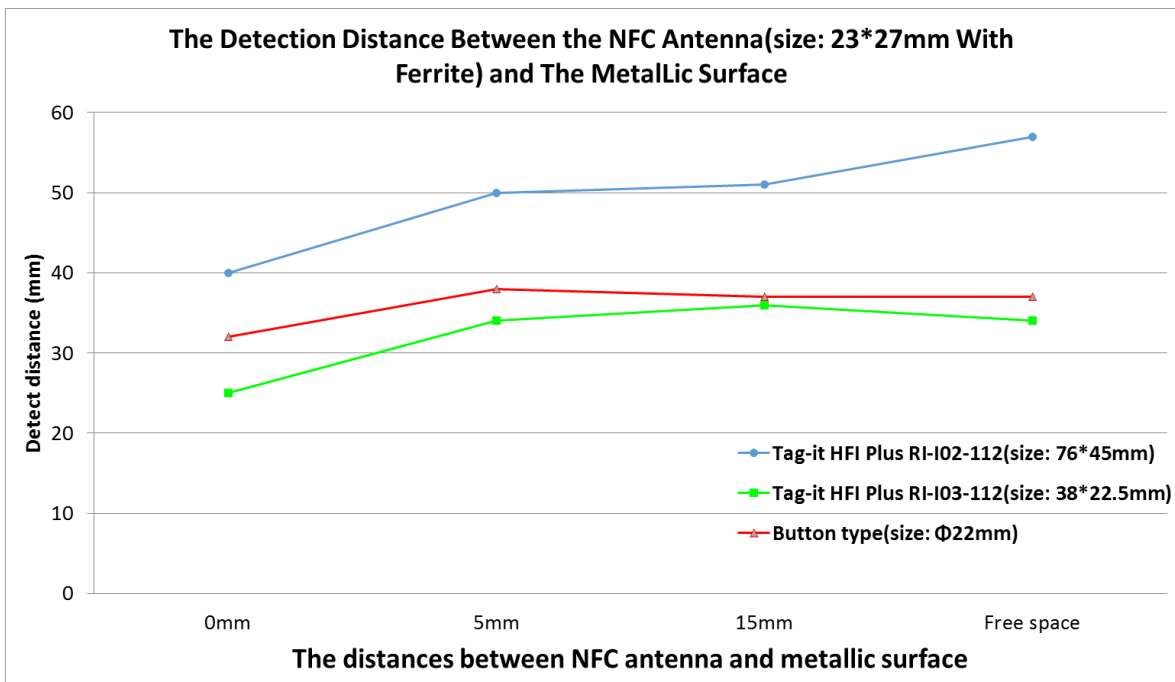

FIGURE10. DETECTION DISTANCE FOR NFC ANTENNA 23*27MM (WITH FERRITE)

REVISION: A1	ECR/ECN INFORMATION: EC No: 119740 DATE: 2017/02/09	TITLE: Rectangular Standard NFC Antenna Application Specification	SHEET No. 7 of 10
DOCUMENT NUMBER: AS-146236-001	CREATED / REVISED BY: Benson Liu 2017/02/09	CHECKED BY: Ryan Liu 2017/02/09	APPROVED BY: Welson Tan 2017/02/09



APPLICATION SPECIFICATION

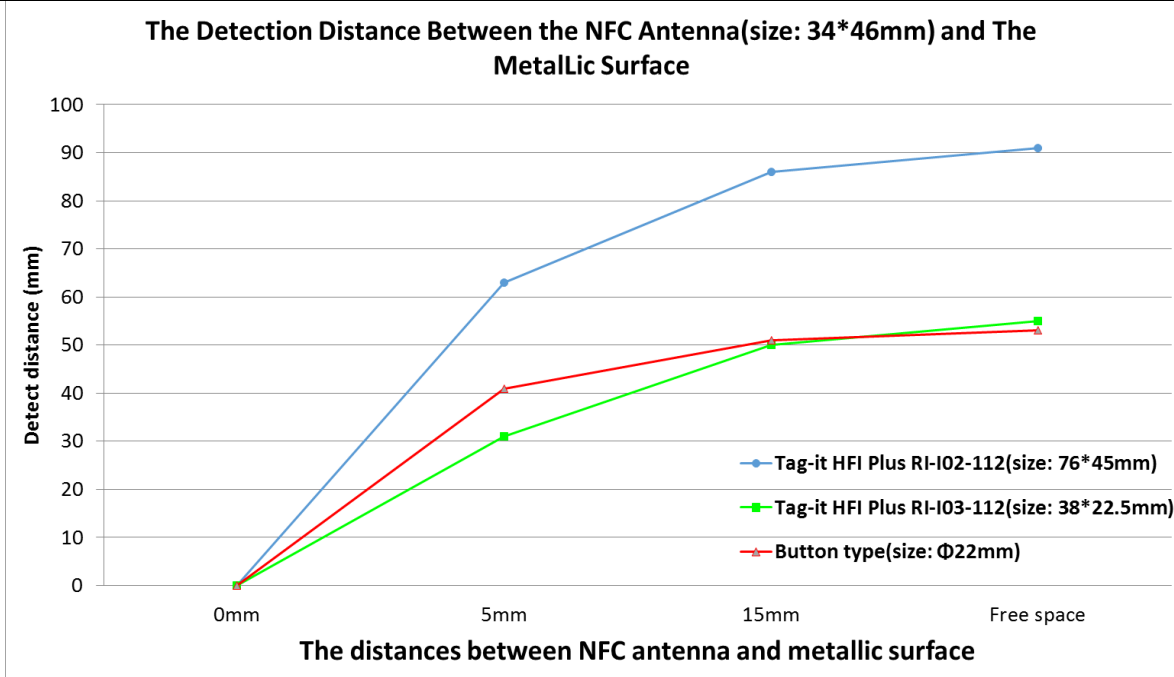

FIGURE11. DETECTION DISTANCE FOR NFC ANTENNA 34*46MM

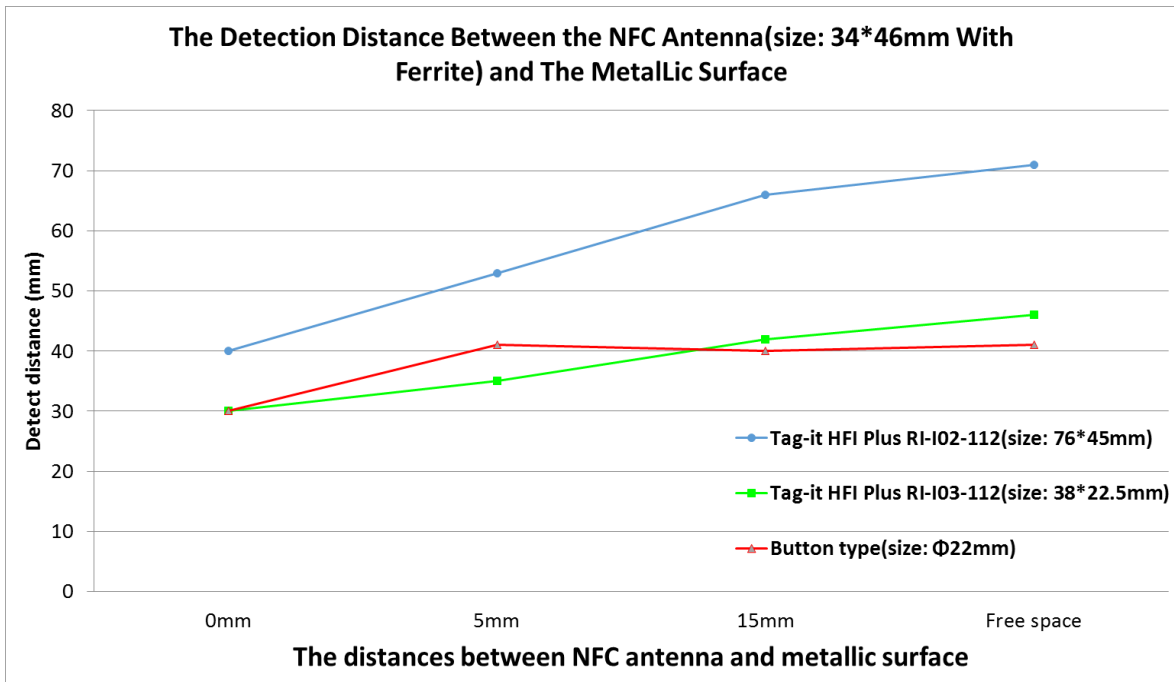

FIGURE12. DETECTION DISTANCE FOR NFC ANTENNA 34*46MM (WITH FERRITE)

REVISION: A1	ECR/ECN INFORMATION: EC No: 119740 DATE: 2017/02/09	TITLE: Rectangular Standard NFC Antenna Application Specification	SHEET No. 8 of 10
DOCUMENT NUMBER: AS-146236-001	CREATED / REVISED BY: Benson Liu 2017/02/09	CHECKED BY: Ryan Liu 2017/02/09	APPROVED BY: Welson Tan 2017/02/09



APPLICATION SPECIFICATION

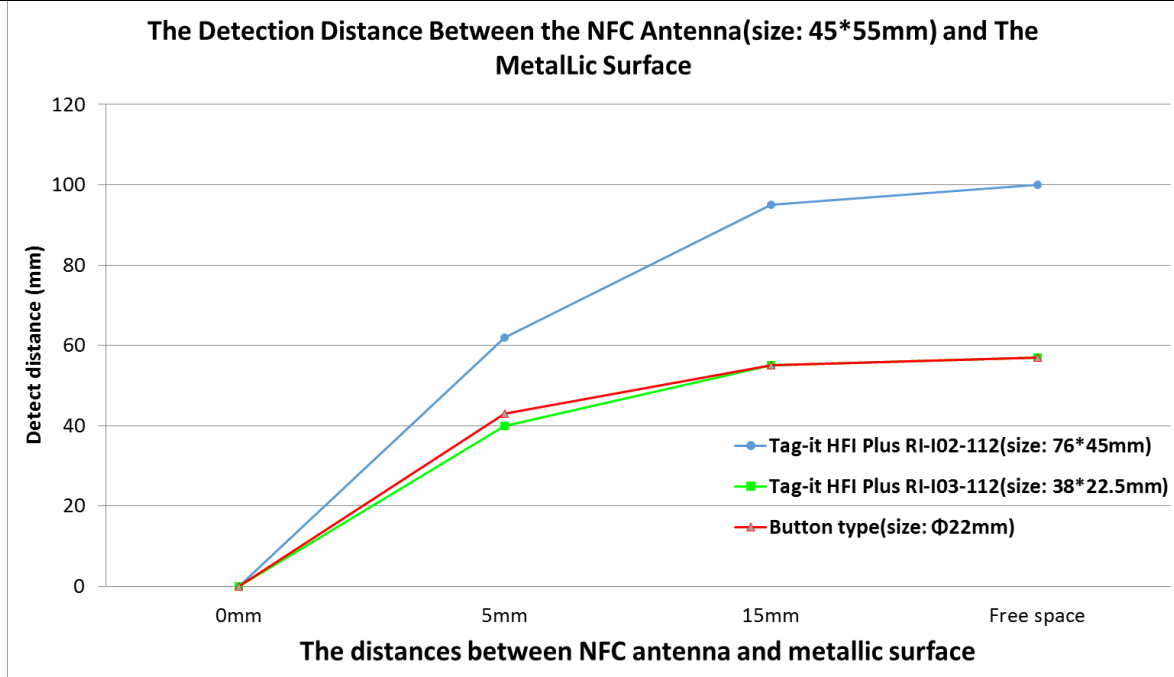

FIGURE13. DETECTION DISTANCE FOR NFC ANTENNA 45*55MM

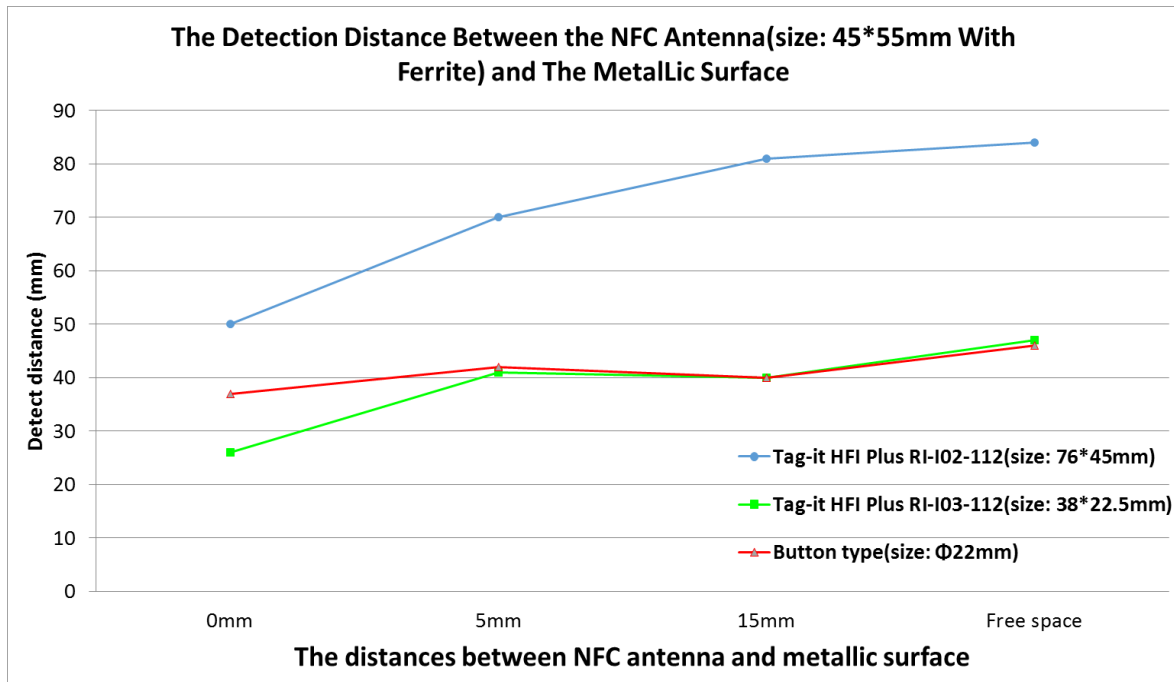

FIGURE14. DETECTION DISTANCE FOR NFC ANTENNA 45*55MM (WITH FERRITE)

REVISION: A1	ECR/ECN INFORMATION: EC No: 119740 DATE: 2017/02/09	TITLE: Rectangular Standard NFC Antenna Application Specification	SHEET No. 9 of 10
DOCUMENT NUMBER: AS-146236-001	CREATED / REVISED BY: Benson Liu 2017/02/09	CHECKED BY: Ryan Liu 2017/02/09	APPROVED BY: Welson Tan 2017/02/09

5.0 MATCHING CIRCUITS

The matching network will depend on the selected NFC antenna and the NFC chipset. When customer apply the NFC antennas, the matching network should be used as well. During the detection distance test, in order to get good detection distance, the NFC antennas have been well matched on the evaluation board with various capacitor's value. The below picture shows the matching network for the evaluation board while the below table shows the reference capacitor values for each NFC antenna.

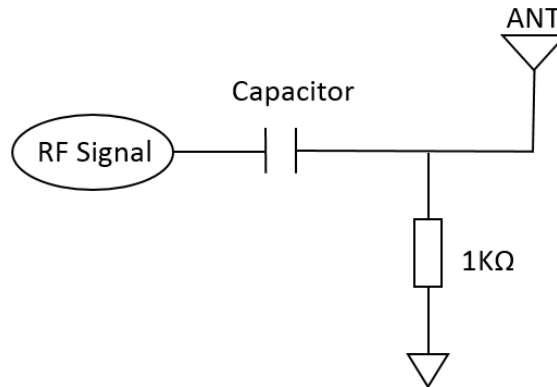

FIGURE15. MATCHING NETWORK ON THE EVALUATION BOARD

	Rectangular Standard NFC Antenna 15X25	Rectangular Standard NFC Antenna 23X27	Rectangular Standard NFC Antenna 34X46	Rectangular Standard NFC Antenna 45X55
Capacitor Values	68pF	68pF	36pF	47pF
	Rectangular Standard NFC Antenna 15X25 (With Ferrite)	Rectangular Standard NFC Antenna 23X27 (With Ferrite)	Rectangular Standard NFC Antenna 34X46 (With Ferrite)	Rectangular Standard NFC Antenna 45X55 (With Ferrite)
Capacitor Values	51pF	51pF	30pF	33pF

TABLE2. CAPACITOR VALUES FOR NFC ANTENNA MATCHING NETWORK

6.0 ASSEMBLY GUIDELINES

The rectangular standard NFC antenna can be adhered on the plastic and we recommend to use Molex material 1054390005(spring clip) to feed these NFC antennas or designed by user self. However, the distance between these NFC antennas and the metal part will affect the detection distance, which depends on customer requirements.

REVISION: A1	ECR/ECN INFORMATION: EC No: 119740 DATE: 2017/02/09	TITLE: Rectangular Standard NFC Antenna Application Specification	SHEET No. 10 of 10
DOCUMENT NUMBER: AS-146236-001	CREATED / REVISED BY: Benson Liu 2017/02/09	CHECKED BY: Ryan Liu 2017/02/09	APPROVED BY: Welson Tan 2017/02/09