

RTC Backup

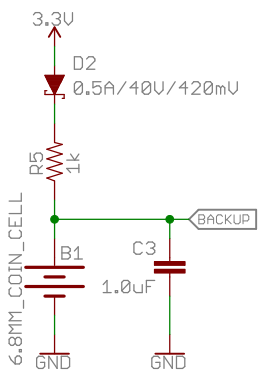

Ublox NEO-M8P

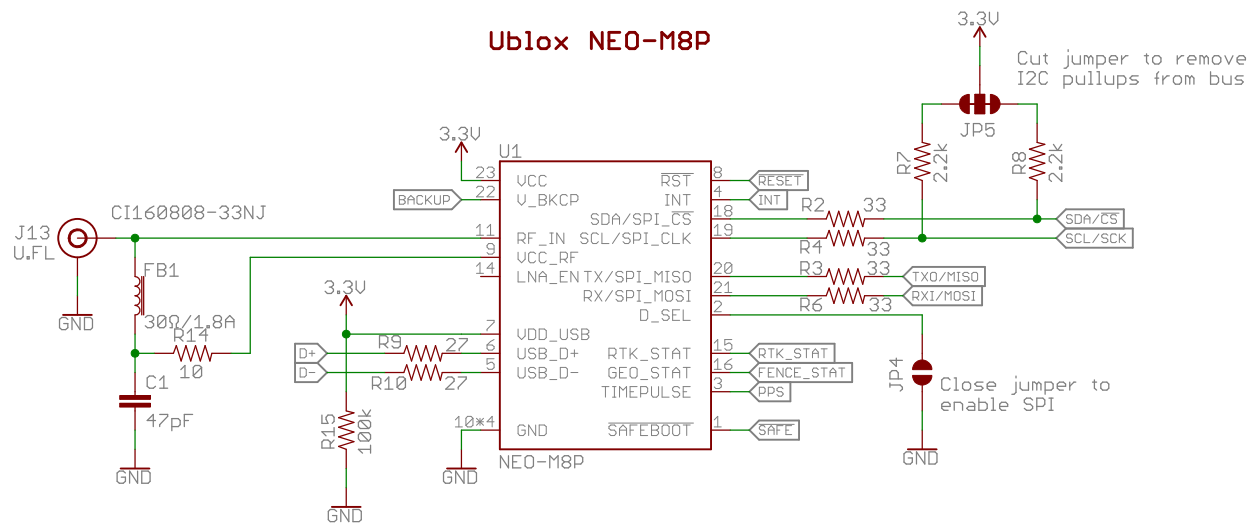

7-bit unshifted I2C address: 0x42

Stat LEDs

Cut jumper to disable LED

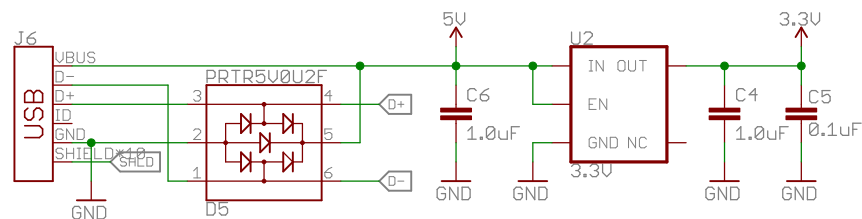
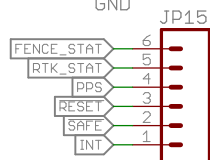
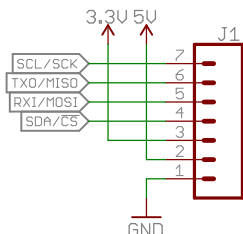
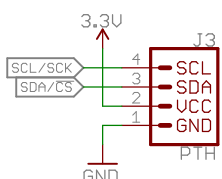
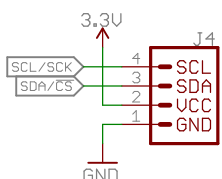
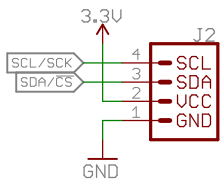
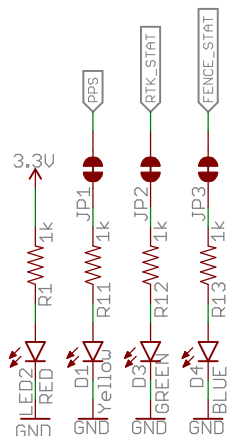

Released under the Creative Commons Attribution Share-Alike 4.0 License
<https://creativecommons.org/licenses/by-sa/4.0/>

TITLE: Qwiic GPS-RTK - ublox NEO-M8P

Design by:

REV:
U10

Date: 9/21/2018 8:26 AM

Sheet: 1/1