



5DAW_2 Series

5W - Dual/Single Output - Ultra Wide Input - Isolated & Regulated DC-DC Converter

DC-DC Converter

5 Watt

- ⊕ **Wide 2:1 Input Voltage Range**
- ⊕ **Very Low Stand-by (no-load) Power Consumption**
- ⊕ **50mW typ. and 150mW max.**
- ⊕ **High Efficiency up to 86%**
- ⊕ **5W Single and Dual outputs**
- ⊕ **I/O Isolation 2KVDC, 4KVDC and 6KVDC Option**
- ⊕ **Operating Temperature Range -40°C to +75°C**
- ⊕ **Continuous Short Circuit Protection (SCP)**
- ⊕ **Remote ON/OFF Control add Suffix „CTRL“ Option**
- ⊕ **A&B&C Pinning Option**

The 5DAW_2 series are specially designed for applications where a wide range input voltage power supplies are isolated from the input power supply in a distributed power supply system on a circuit board.

These products apply to:

- 1) Where the voltage of the input power supply is wide range (voltage range $\leq 2:1$);
- 2) Where isolation is necessary between input and output (isolation $\leq 2000\text{VDC}$, $\leq 4000\text{VDC}$, $\leq 6000\text{VDC}$);
- 3) Where the regulation of the output voltage and the output ripple noise are demanded.



Common specifications	
Input filter:	Pi type
Short circuit protection:	Continuous
Temperature rise at full load:	21°C TYP
Cooling:	Free air convection
Operation temperature range:	-40°C~+100°C
Operation case temperature:	+110°C MAX
Storage temperature range:	-55°C ~+125°C
Storage humidity range:	< 95%
Lead temperature range:	300°C MAX, 1.5mm from case for 10 sec
No-load power consumption:	50mW TYP / 150mW MAX
Temperature coefficient:	-40°C to +85°C ambient 0.015 %/°C TYP
Operating Frequency:	200kHz MIN
Case material:	Non-conductive black plastic [UL94-V0]
Potting material:	Epoxy [UL94-V0]
MTBF (MIL-HDBK 217F):	+25°C: 2597x10 ³ hours +75°C: 313x10 ³ hours
Weight:	13g

Output specifications						
Item	Test condition	Min	Typ	Max	Units	
Output voltage accuracy	Nominal Vin and full load		±2		%	
Line voltage regulation	Vin=min to max, full load		±0.5		%	
Load voltage regulation	20% to 100% full load		±0.5		%	
Output Ripple & Noise	20MHz Bandwidth			60	mVp-p	
Remote Power OFF (leave open if not used) (15 VDC max.)	Device ON				open or <0.8 VDC	
	Device OFF Device OFF (Stand by input current)				CTRL>1.5VDC 0.5mA max.	

Model selection:

WCTV_xxyyN##

W= Watt; **C=** Case; **T=** Type; **V=** Voltage Variation (omitted $\pm 10\%$);
xx= Vin; **yy=**Vout; **N=** Numbers of Output; **##=** Isolation (kVDC)

Example:

5DAW_2405D6

5= 5Watt; **D=** DIP; **A=** series; **W=** wide input (2:1) 18-36Vin; **5Vout**;
D= Dual Output; **6=** 6000VDC

Isolation specifications						
Item	Test condition	Min	Typ	Max	Units	
Isolation voltage	• Isolation test voltage (tested for 1 sec.)	2200			VDC	
		4400			VDC	
		6300			VDC	
	• I/O isolation voltage (60 sec.)	2000			VDC	
		4000			VDC	
	6000			VDC		
Isolation resistance	500VDC, input to output	15			GΩ	
Isolation capacitance	100KHz			30	pF	

Note:

1. All specifications measured at Ta=25°C, humidity<75%, nominal input voltage and rated output load unless otherwise specified.
2. In this datasheet, all the test methods of indications are based on corporate standards.
3. Only typical models listed, other models may be different, please contact our technical person for more details.

5DAW_2 Series

5W - Dual/Single Output - Wide Input - Isolated & Regulated DC-DC Converter

Part Number	Input Voltage [V]	Output Voltage [VDC]	Output Current [mA, max]	Efficiency [%, typ]	Max. Capacitive Load [μ F]
5DAW_xx03SX	4.5-9, 9-18, 18-36, 36-75	3.3	1200	79-81	1000
5DAW_xx05SX	4.5-9, 9-18, 18-36, 36-75	5	1000	82-84	1000
5DAW_xx09SX	4.5-9, 9-18, 18-36, 36-75	9	556	82-86	680
5DAW_xx12SX	4.5-9, 9-18, 18-36, 36-75	12	420	84-87	470
5DAW_xx15SX	4.5-9, 9-18, 18-36, 36-75	15	333	85-87	330
5DAW_xx05DX	4.5-9, 9-18, 18-36, 36-75	\pm 5	\pm 500	81-84	\pm 470
5DAW_xx12DX	4.5-9, 9-18, 18-36, 36-75	\pm 12	\pm 210	84-87	\pm 100
5DAW_xx15DX	4.5-9, 9-18, 18-36, 36-75	\pm 15	\pm 167	85-87	\pm 47

- X=2=2KVDC, X=4=4KVDC, X=6=6KVDC
- xx=Input Voltage (possible for other input and output voltage combinations on request)
 - Vin=4.5-9V, xx=05
 - Vin=9-18V, xx=12
 - Vin=18-36V, xx=24
 - Vin=36-75V, xx=48
- For B or C Pinning: 5DBW_xx03SX or 5DCW_xx03SX

Mechanical dimensions/footprint

A Pinning

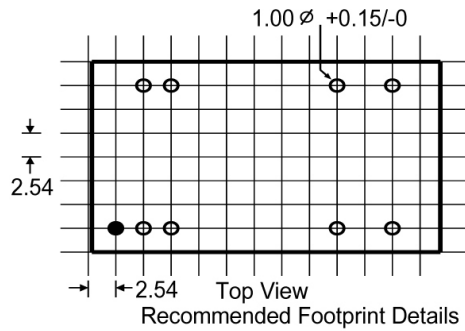
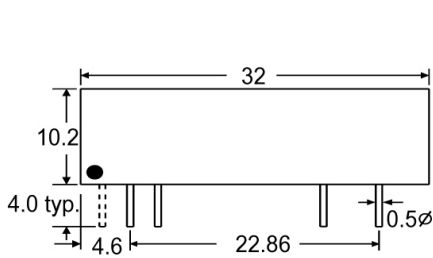

Pin Connections

Pin#	Single	Dual
1(option)	CTRL	CTRL
2	-Vin	-Vin
3	-Vin	-Vin
9	NC	Com
11	NC	-Vout
14	+Vout	+Vout
16	-Vout	COM
22	+Vin	+Vin
23	+Vin	+Vin

NC=No Connection
CTRL=Remote ON/OFF Control

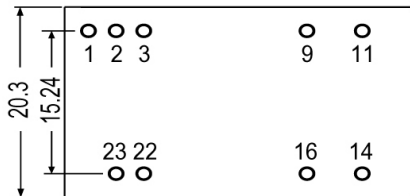

Bottom View

Note:
XX.X \pm 0.25 mm
XX.XX \pm 0.15 mm

XX.X \pm 0.25 mm

XX.XX \pm 0.15 mm

B Pinning

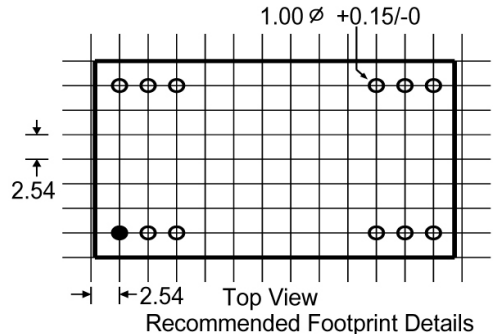
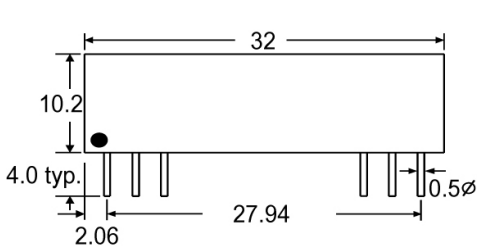

Pin Connections

Pin#	Single	Dual
1	+Vin	+Vin
2	NC	-Vout
3	NC	Com
10	-Vout	Com
11	+Vout	+Vout
12	-Vin	-Vin
13	-Vin	-Vin
14	+Vout	+Vout
15	-Vout	Com
22	NC	Com
23	NC	-Vout
24	+Vin	+Vin

NC=No Connection

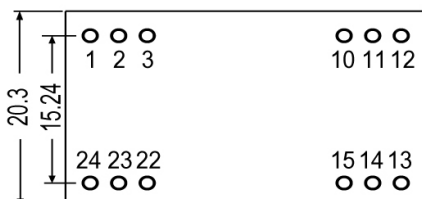

Bottom View

Note:
XX.X \pm 0.25 mm
XX.XX \pm 0.15 mm

5DAW_2 Series

5W - Dual/Single Output - Wide Input - Isolated & Regulated
DC-DC Converter

Mechanical dimensions/footprint

C Pinning

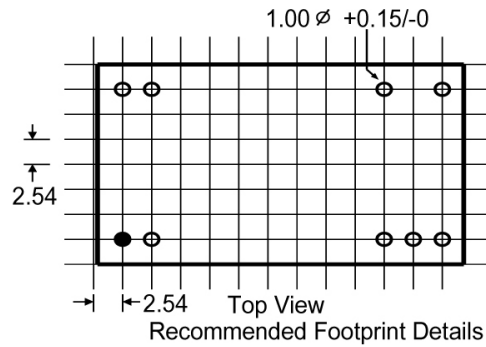
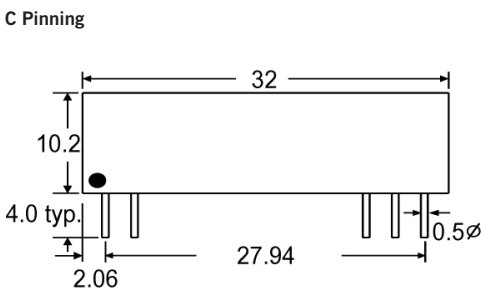

Pin Connections

Pin#	Single	Dual
1	+Vin	+Vin
2	+Vin	+Vin
10	NC	Com
11	NC	Com
12	-Vout	NC
13	+Vout	-Vout
15	NC	+Vout
23	-Vin	-Vin
24	-Vin	-Vin

NC=No Connection

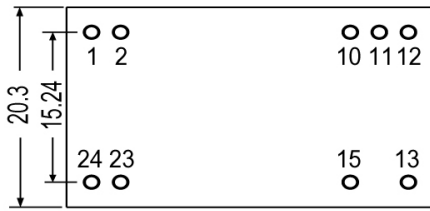

Bottom View

Note:
XX.X ± 0.25 mm
XX.XX ± 0.15 mm

Functional block diagram (A pinning)

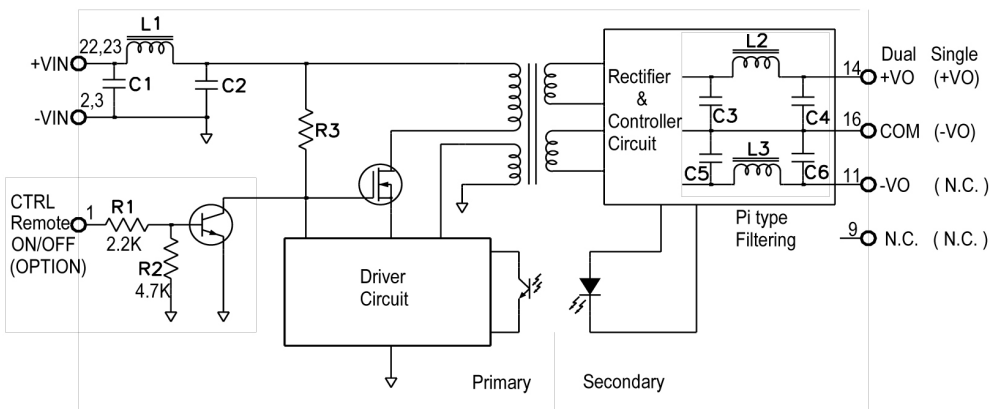

The Values of Input π type Filtering

Input Voltage	C1	C2	L1
4.5~9, 9~18VDC	1uF~10uF	10uF/25V	0.47uH~4.7uH
18~36VDC	0.1uF~1uF	4.7uF/50V	1uH~10uH
36~75VDC	0.1uF~1uF	1uF/100V	2.2uH~22uH

5DAW_2 Series

5W - Dual/Single Output - Wide Input - Isolated & Regulated DC-DC Converter

Typical characteristics

Derating Graph

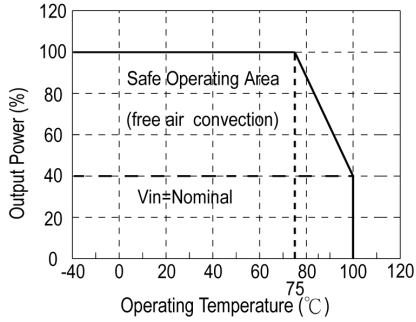

Efficiency Vs Load (single) @ Vin=Nominal

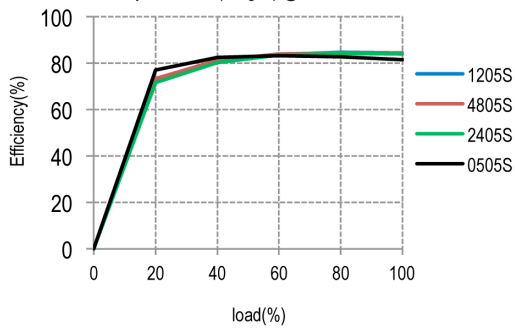

Efficiency Vs Vin (single) @ Full Load

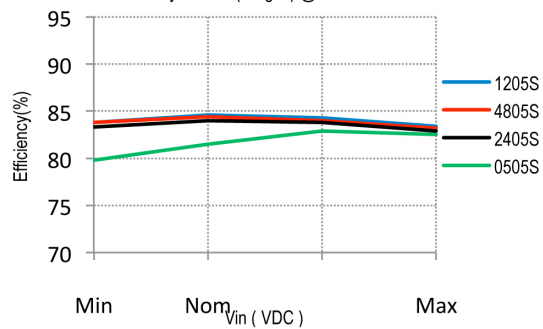

Efficiency Vs Load (dual) @ Vin=Nominal

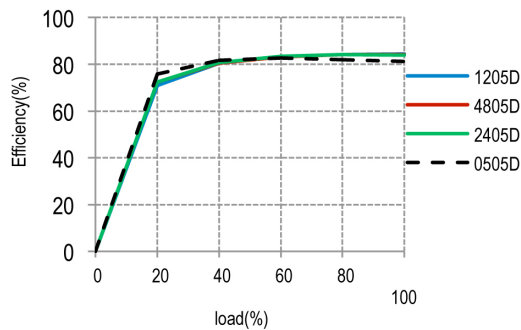

Efficiency Vs Vin (dual) @ Full Load

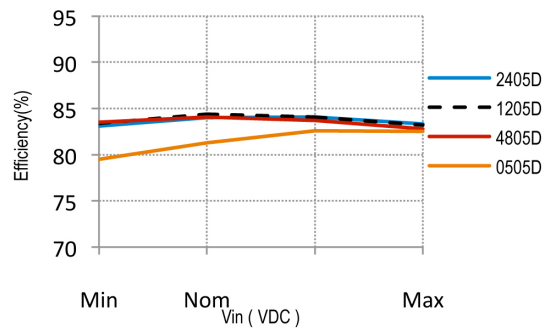

Tube outline

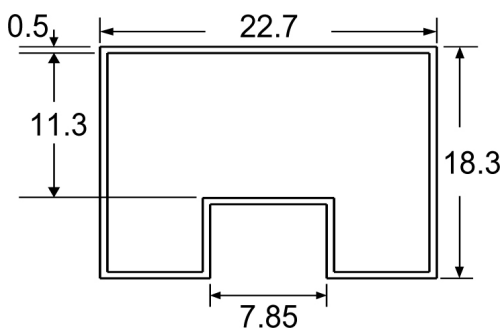

Note:
Unit: mm
General tolerances: ±0.50mm

L=530mm ±2mm
Tube quantity: 15pcs