

| NO. CKTS | DIM. A | DIM. B |
|----------|----------------|----------------|
| 2 | 5.08 .200 | 2.54 .100 |
| 3 | 7.62 .300 | 5.08 .200 |
| 4 | 10.16 .400 | 7.62 .300 |
| 5 | 12.70 .500 | 10.16 .400 |
| 6 | 15.24 .600 | 12.70 .500 |
| 7 | 17.78 .700 | 15.24 .600 |
| 8 | 20.32 .800 | 17.78 .700 |
| 9 | 22.86 .900 | 20.32 .800 |
| 10 | 25.40 1.000 | 22.86 .900 |
| 11 | 27.94 1.100 | 25.40 1.000 |
| 12 | 30.48 1.200 | 27.94 1.100 |
| 13 | 33.02 1.300 | 30.48 1.200 |
| 14 | 35.56 1.400 | 33.02 1.300 |
| 15 | 38.10 1.500 | 35.56 1.400 |
| 16 | 40.64 1.600 | 38.10 1.500 |
| 17 | 43.18 1.700 | 40.64 1.600 |
| 18 | 45.72 1.800 | 43.18 1.700 |
| 19 | 48.26 1.900 | 45.72 1.800 |
| 20 | 50.80 2.000 | 48.26 1.900 |
| 21 | 53.34 2.100 | 50.80 2.000 |
| 22 | 55.88 2.200 | 53.34 2.100 |
| 23 | 58.42 2.300 | 55.88 2.200 |
| 24 | 60.96 2.400 | 58.42 2.300 |
| 25 | 63.50 2.500 | 60.96 2.400 |
| 26 | 66.04 2.600 | 63.50 2.500 |
| 27 | 68.58 2.700 | 66.04 2.600 |
| 28 | 71.12 2.800 | 68.58 2.700 |
| 29 | 73.66 2.900 | 71.12 2.800 |
| 30 | 76.20 3.000 | 73.66 2.900 |
| 31 | 78.74 3.100 | 76.20 3.000 |
| 32 | 81.28 3.200 | 78.74 3.100 |
| 33 | 83.82 3.300 | 81.28 3.200 |
| 34 | 86.36 3.400 | 83.82 3.300 |
| 35 | 88.90 3.500 | 86.36 3.400 |
| 36 | 91.44 3.600 | 88.90 3.500 |

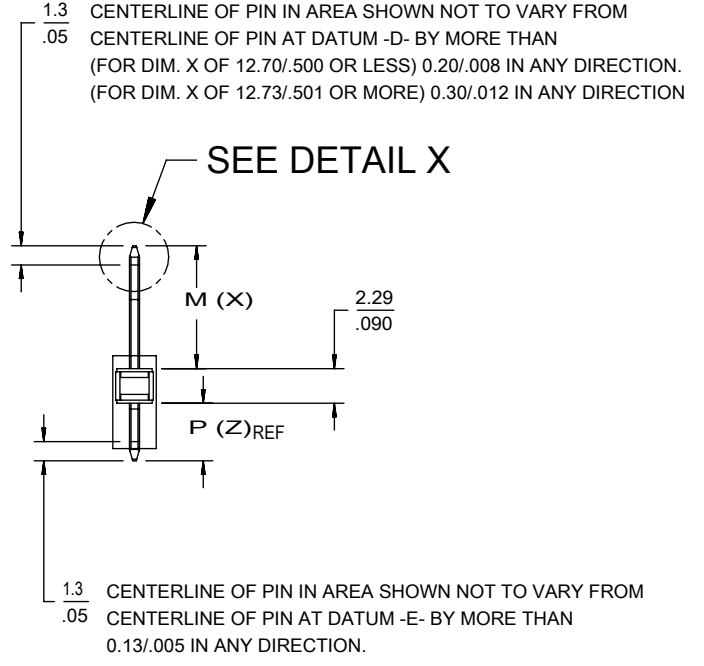

- NOTES:
- MATERIAL: GLASS FILLED NYLON
U.L. 94V-0, COLOR: BLACK
 - FINISH: (SEE LAST 3 DIGITS OF PIN NUMBER)
(154) OVERALL TIN: 0.00254/.000100 MIN. OVER NICKEL: 0.00127/.000050 MIN.
(118) OVERALL TIN: 0.00152/.000060 MIN. OVER NICKEL: 0.00127/.000050 MIN.
(208) SELECT GOLD: 0.00038/.000015 MIN, SELECT TIN: 0.00254/.000100 MIN, WITH OVERALL NICKEL UNDERPLATE: 0.00127/.000050 MIN.
(228) SELECT GOLD: 0.00076/.000030 MIN, SELECT TIN: 0.00254/.000100 MIN, WITH OVERALL NICKEL UNDERPLATE: 0.00127/.000050 MIN.
 - PRODUCT SPECIFICATION PS-10-07.
 - PACKAGING INFORMATION: SEE TABLES
 - SOLDERABILITY PER SMES-152.
 - KINK PIN OPTION NOT RECOMMENDED FOR 2 CIRCUIT PARTS. HOLE SIZE MAY NEED TO BE ADJUSTED FOR 2 CIRCUIT PARTS WITH KINK OPTION FOR PROPER INSERTION INTO THE PCB. SEE SMES-42003 FOR ADDITIONAL INFORMATION ON KINK PIN DIRECTION AND PLACEMENT.
 - HEADERS ARE NOT STACKABLE ON 2.54/.100 CENTERS.
 - PIN PUSH OUT FORCE: 3 LBS. MIN
 - THIS PART CONFORMS TO CLASS B REQUIREMENTS OF COSMETIC SPECIFICATION PS-45499-002.
 - PIN TIP DIMENSIONS ARE SHOWN FOR REFERENCE ONLY. DIMENSIONS APPLY PRIOR TO PLATING OR ASSEMBLY.
 - TEXT ON PART IS FOR REFERENCE ONLY. TEXT AND TEXT LOCATION MAY VARY DEPENDING ON PART NUMBER AND/OR TOOL.



| SYMBOLS | | THIS DRAWING CONTAINS INFORMATION THAT IS PROPRIETARY TO MOLEX ELECTRONIC TECHNOLOGIES, LLC AND SHOULD NOT BE USED WITHOUT WRITTEN PERMISSION | |
|---------|--|---|--|
| ▽ = 0 | DIMENSION UNITS | SCALE | CURRENT REV DESC: GOLD LENGTH SPEC CHANGED AS MIN 2.54- MAX 5.54 FOR A-42375-0037/0071 |
| ▽ = 0 | MM/IN | 2:1 | |
| ▽ = 0 | GENERAL TOLERANCES (UNLESS SPECIFIED) | | |
| ▽ = 0 | | MM | INCH |
| ▽ = 0 | 4 PLACES ± | ± | EC NO: 689596 |
| ▽ = 0 | 3 PLACES ± | ± 0.01 | DRWN: SHRUTJ 2021/09/14 |
| ▽ = 0 | 2 PLACES ± | ± 0.25 | CHK'D: SHRUTJ 2021/12/20 |
| ▽ = 0 | 1 PLACE ± | ± 0.38 | APPR: ISHWARG 2021/12/20 |
| ▽ = 0 | 0 PLACES ± | ± | INITIAL REVISION: |
| ▽ = 0 | ANGULAR TOL | ± 0.5° | DRWN: SCHAFFER 2003/02/11 |
| ▽ = 0 | DRAFT WHERE APPLICABLE MUST REMAIN WITHIN DIMENSIONS | | APPR: MARGULIS 2004/02/27 |
| ▽ = 0 | THIRD ANGLE PROJECTION | | SERIES |
| ▽ = 0 | DRAWING | | MATERIAL NUMBER |
| ▽ = 0 | B-SIZE | | CUSTOMER |
| ▽ = 0 | 42375 | | SHEET NUMBER |
| ▽ = 0 | SEE CHART | | 1 OF 35 |

molex

KK 100 HEADER ASSY
FLAT VERTICAL BREAKAWAY

PRODUCT CUSTOMER DRAWING

| | | | |
|-----------------|----------|----------|----------|
| DOCUMENT NUMBER | DOC TYPE | DOC PART | REVISION |
| SD-42375-001 | PSD | 001 | V |

| | | | |
|-----------------|----|--------------|---------------------|
| DOCUMENT STATUS | P1 | RELEASE DATE | 2021/12/20 12:18:33 |
|-----------------|----|--------------|---------------------|

| ENG. NO: A-42375-0002/0036 | | | | | |
|----------------------------|-----------------|--------------------|------|-----------------|--------------|
| HEADER NUMBER: | | 42312-0036 | | | |
| PIN NUMBER: | | 42663-ABA154 | | | |
| PIN LENGTH: L | | .455 / 11.56 | | | |
| MATING LENGTH: M | | .240 / 6.09 | | | |
| GOLD POINT: G | | N/A | | | |
| PC TAIL LENGTH: P | | .125 / 3.18 | | | |
| TIN: T | | OVERALL | | | |
| CKTS: | | 2-36 | | | |
| KINKS: | | NO | | | |
| VOIDED CKTS: | | NONE | | | |
| PACKAGING: | | BULK PK-40873-0041 | | | |
| CKTS | MATERIAL NUMBER | ENG NUMBER | CKTS | MATERIAL NUMBER | ENG MATERIAL |
| 2 | 22-28-4020 | A-42375-0002 | 20 | 22-28-4200 | 22-28-4200 |
| 3 | 22-28-4030 | A-42375-0003 | 21 | 22-28-4210 | 22-28-4210 |
| 4 | 22-28-4040 | A-42375-0004 | 22 | 22-28-4220 | 22-28-4220 |
| 5 | 22-28-4050 | A-42375-0005 | 23 | 22-28-4230 | 22-28-4230 |
| 6 | 22-28-4060 | A-42375-0006 | 24 | 22-28-4240 | 22-28-4240 |
| 7 | 22-28-4070 | A-42375-0007 | 25 | 22-28-4250 | 22-28-4250 |
| 8 | 22-28-4080 | A-42375-0008 | 26 | 22-28-4260 | 22-28-4260 |
| 9 | 22-28-4090 | A-42375-0009 | 27 | 22-28-4270 | 22-28-4270 |
| 10 | 22-28-4100 | A-42375-0010 | 28 | 22-28-4280 | 22-28-4280 |
| 11 | 22-28-4110 | A-42375-0011 | 29 | 22-28-4290 | 22-28-4290 |
| 12 | 22-28-4120 | A-42375-0012 | 30 | 22-28-4300 | 22-28-4300 |
| 13 | 22-28-4130 | A-42375-0013 | 31 | 22-28-4310 | 22-28-4310 |
| 14 | 22-28-4140 | A-42375-0014 | 32 | 22-28-4320 | 22-28-4320 |
| 15 | 22-28-4150 | A-42375-0015 | 33 | 22-28-4330 | 22-28-4330 |
| 16 | 22-28-4160 | A-42375-0016 | 34 | 22-28-4340 | 22-28-4340 |
| 17 | 22-28-4170 | A-42375-0017 | 35 | 22-28-4350 | 22-28-4350 |
| 18 | 22-28-4180 | A-42375-0018 | 36 | 22-28-4360 | 22-28-4360 |
| 19 | 22-28-4190 | A-42375-0019 | | | |

| ENG. NO: A-42375-0037/0071 | | | | | |
|----------------------------|-----------------|----------------------------------|------|-----------------|--------------|
| HEADER NUMBER: | | 42312-0036 | | | |
| PIN NUMBER: | | 42663-ABB208 | | | |
| PIN LENGTH: L | | .455 / 11.56 | | | |
| MATING LENGTH: M | | .240 / 6.09 | | | |
| GOLD POINT: G | | .100 / 2.54 Min - 0.218/5.54 Max | | | |
| PC TAIL LENGTH: P | | .125 / 3.18 | | | |
| TIN: T | | .100 / 2.54 | | | |
| CKTS: | | 2-36 | | | |
| KINKS: | | NO | | | |
| VOIDED CKTS: | | NONE | | | |
| PACKAGING: | | BULK PK-40873-0041 | | | |
| CKTS | MATERIAL NUMBER | ENG NUMBER | CKTS | MATERIAL NUMBER | ENG MATERIAL |
| 2 | 22-28-4023 | A-42375-0037 | 20 | 22-28-4203 | A-42375-0055 |
| 3 | 22-28-4033 | A-42375-0038 | 21 | 22-28-4213 | A-42375-0056 |
| 4 | 22-28-4043 | A-42375-0039 | 22 | 22-28-4223 | A-42375-0057 |
| 5 | 22-28-4053 | A-42375-0040 | 23 | 22-28-4233 | A-42375-0058 |
| 6 | 22-28-4063 | A-42375-0041 | 24 | 22-28-4243 | A-42375-0059 |
| 7 | 22-28-4073 | A-42375-0042 | 25 | 22-28-4253 | A-42375-0060 |
| 8 | 22-28-4083 | A-42375-0043 | 26 | 22-28-4263 | A-42375-0061 |
| 9 | 22-28-4093 | A-42375-0044 | 27 | 22-28-4273 | A-42375-0062 |
| 10 | 22-28-4103 | A-42375-0045 | 28 | 22-28-4283 | A-42375-0063 |
| 11 | 22-28-4113 | A-42375-0046 | 29 | 22-28-4293 | A-42375-0064 |
| 12 | 22-28-4123 | A-42375-0047 | 30 | 22-28-4303 | A-42375-0065 |
| 13 | 22-28-4133 | A-42375-0048 | 31 | 22-28-4313 | A-42375-0066 |
| 14 | 22-28-4143 | A-42375-0049 | 32 | 22-28-4323 | A-42375-0067 |
| 15 | 22-28-4153 | A-42375-0050 | 33 | 22-28-4333 | A-42375-0068 |
| 16 | 22-28-4163 | A-42375-0051 | 34 | 22-28-4343 | A-42375-0069 |
| 17 | 22-28-4173 | A-42375-0052 | 35 | 22-28-4353 | A-42375-0070 |
| 18 | 22-28-4183 | A-42375-0053 | 36 | 22-28-4363 | A-42375-0071 |
| 19 | 22-28-4193 | A-42375-0054 | | | |

| | | | |
|--|---|---|---|
| SYMBOLS = 0 = 0 = 0 = 0 = 0 = 0 = 0 = 0 | THIS DRAWING CONTAINS INFORMATION THAT IS PROPRIETARY TO MOLEX ELECTRONIC TECHNOLOGIES, LLC AND SHOULD NOT BE USED WITHOUT WRITTEN PERMISSION DIMENSION UNITS: MM/IN SCALE: 1:1 | CURRENT REV DESC: GOLD LENGTH SPEC CHANGED AS MIN 2.54- MAX 5.54 FOR A-42375-0037/0071 | KK 100 HEADER ASSY FLAT VERTICAL BREAKAWAY PRODUCT CUSTOMER DRAWING |
| | GENERAL TOLERANCES (UNLESS SPECIFIED) | EC NO: 689596 DRWN: SHRUTJ 2021/09/14 CHK'D: SHRUTJ 2021/12/20 APPR: ISHWARG 2021/12/20 | |
| | 4 PLACES ± 3 PLACES ± 0.01 2 PLACES ± 0.25 1 PLACE ± 0.38 0 PLACES ± | INITIAL REVISION: DRWN: SCHAFFER 2003/02/11 APPR: MARGULIS 2004/02/27 | |
| | ANGULAR TOL ± 0.5° DRAFT WHERE APPLICABLE MUST REMAIN WITHIN DIMENSIONS | THIRD ANGLE PROJECTION DRAWING SERIES: B-SIZE 42375 MATERIAL NUMBER: SEE CHART CUSTOMER: GENERAL MARKET SHEET NUMBER: 2 OF 35 | |

| ENG. NO: A-42375-0072/0106 | | | | | |
|----------------------------|-----------------|--------------------|------|-----------------|--------------|
| HEADER NUMBER: | | 42312-0036 | | | |
| PIN NUMBER: | | 42663-ABB228 | | | |
| PIN LENGTH: L | | .455 / 11.56 | | | |
| MATING LENGTH: M | | .240 / 6.09 | | | |
| GOLD POINT: G | | .100 / 2.54 | | | |
| PC TAIL LENGTH: P | | .125 / 3.18 | | | |
| TIN: T | | .100 / 2.54 | | | |
| CKTS: | | 2-36 | | | |
| KINKS: | | NO | | | |
| VOIDED CKTS: | | NONE | | | |
| PACKAGING: | | BULK PK-40873-0041 | | | |
| CKTS | MATERIAL NUMBER | ENG NUMBER | CKTS | MATERIAL NUMBER | ENG NUMBER |
| 2 | 22-28-4026 | A-42375-0072 | 20 | 22-28-4206 | A-42375-0090 |
| 3 | 22-28-4036 | A-42375-0073 | 21 | 22-28-4216 | A-42375-0091 |
| 4 | 22-28-4046 | A-42375-0074 | 22 | 22-28-4226 | A-42375-0092 |
| 5 | 22-28-4056 | A-42375-0075 | 23 | 22-28-4236 | A-42375-0093 |
| 6 | 22-28-4066 | A-42375-0076 | 24 | 22-28-4246 | A-42375-0094 |
| 7 | 22-28-4076 | A-42375-0077 | 25 | 22-28-4256 | A-42375-0095 |
| 8 | 22-28-4086 | A-42375-0078 | 26 | 22-28-4266 | A-42375-0096 |
| 9 | 22-28-4096 | A-42375-0079 | 27 | 22-28-4276 | A-42375-0097 |
| 10 | 22-28-4106 | A-42375-0080 | 28 | 22-28-4286 | A-42375-0098 |
| 11 | 22-28-4116 | A-42375-0081 | 29 | 22-28-4296 | A-42375-0099 |
| 12 | 22-28-4126 | A-42375-0082 | 30 | 22-28-4306 | A-42375-0100 |
| 13 | 22-28-4136 | A-42375-0083 | 31 | 22-28-4316 | A-42375-0101 |
| 14 | 22-28-4146 | A-42375-0084 | 32 | 22-28-4326 | A-42375-0102 |
| 15 | 22-28-4156 | A-42375-0085 | 33 | 22-28-4336 | A-42375-0103 |
| 16 | 22-28-4166 | A-42375-0086 | 34 | 22-28-4346 | A-42375-0104 |
| 17 | 22-28-4176 | A-42375-0087 | 35 | 22-28-4356 | A-42375-0105 |
| 18 | 22-28-4186 | A-42375-0088 | 36 | 22-28-4366 | A-42375-0106 |
| 19 | 22-28-4196 | A-42375-0089 | | | |

| ENG. NO: A-42375-0107/0141 | | | | | |
|----------------------------|-----------------|--------------------|------|-----------------|--------------|
| HEADER NUMBER: | | 42312-0036 | | | |
| PIN NUMBER: | | 42663-ATA154 | | | |
| PIN LENGTH: L | | .530 / 13.46 | | | |
| MATING LENGTH: M | | .320 / 8.13 | | | |
| GOLD POINT: G | | N/A | | | |
| PC TAIL LENGTH: P | | .120 / 3.05 | | | |
| TIN: T | | .120 / 3.05 | | | |
| CKTS: | | 2-36 | | | |
| KINKS: | | NO | | | |
| VOIDED CKTS: | | NONE | | | |
| PACKAGING: | | BULK PK-40873-0041 | | | |
| CKTS | MATERIAL NUMBER | ENG NUMBER | CKTS | MATERIAL NUMBER | ENG NUMBER |
| 2 | 22-28-4021 | A-42375-0107 | 20 | 22-28-4201 | A-42375-0125 |
| 3 | 22-28-4031 | A-42375-0108 | 21 | 22-28-4211 | A-42375-0126 |
| 4 | 22-28-4041 | A-42375-0109 | 22 | 22-28-4221 | A-42375-0127 |
| 5 | 22-28-4051 | A-42375-0110 | 23 | 22-28-4231 | A-42375-0128 |
| 6 | 22-28-4061 | A-42375-0111 | 24 | 22-28-4241 | A-42375-0129 |
| 7 | 22-28-4071 | A-42375-0112 | 25 | 22-28-4251 | A-42375-0130 |
| 8 | 22-28-4081 | A-42375-0113 | 26 | 22-28-4261 | A-42375-0131 |
| 9 | 22-28-4091 | A-42375-0114 | 27 | 22-28-4271 | A-42375-0132 |
| 10 | 22-28-4101 | A-42375-0115 | 28 | 22-28-4281 | A-42375-0133 |
| 11 | 22-28-4111 | A-42375-0116 | 29 | 22-28-4291 | A-42375-0134 |
| 12 | 22-28-4121 | A-42375-0117 | 30 | 22-28-4301 | A-42375-0135 |
| 13 | 22-28-4131 | A-42375-0118 | 31 | 22-28-4311 | A-42375-0136 |
| 14 | 22-28-4141 | A-42375-0119 | 32 | 22-28-4321 | A-42375-0137 |
| 15 | 22-28-4151 | A-42375-0120 | 33 | 22-28-4331 | A-42375-0138 |
| 16 | 22-28-4161 | A-42375-0121 | 34 | 22-28-4341 | A-42375-0139 |
| 17 | 22-28-4171 | A-42375-0122 | 35 | 22-28-4351 | A-42375-0140 |
| 18 | 22-28-4181 | A-42375-0123 | 36 | 22-28-4361 | A-42375-0141 |
| 19 | 22-28-4191 | A-42375-0124 | | | |

| | | | |
|---------|---|-------------------|--|
| SYMBOLS | THIS DRAWING CONTAINS INFORMATION THAT IS PROPRIETARY TO MOLEX ELECTRONIC TECHNOLOGIES, LLC AND SHOULD NOT BE USED WITHOUT WRITTEN PERMISSION | | |
| | DIMENSION UNITS | SCALE | CURRENT REV DESC: GOLD LENGTH SPEC CHANGED AS MIN 2.54- MAX 5.54 FOR A-42375-0037/0071 |
| ∇ = 0 | MM/IN | 1:1 | EC NO: 689596 DRWN: SHRUTJ 2021/09/14 CHK'D: SHRUTJ 2021/12/20 APPR: ISHWARG 2021/12/20 |
| ∇ = 0 | GENERAL TOLERANCES (UNLESS SPECIFIED) | | |
| ∇ = 0 | | | INITIAL REVISION: DRWN: SCHAFFER 2003/02/11 APPR: MARGULIS 2004/02/27 |
| ∇ = 0 | 4 PLACES ± | ± | |
| ∇ = 0 | 3 PLACES ± | ± 0.01 | DOCUMENT NUMBER SD-42375-001 |
| ∇ = 0 | 2 PLACES ± | ± 0.25 | |
| ∇ = 0 | 1 PLACE ± | ± 0.38 | DOC TYPE PSD |
| ∇ = 0 | 0 PLACES ± | ± | DOC PART 001 |
| ∇ = 0 | ANGULAR TOL | ± 0.5° | REVISION V |
| ∇ = 0 | DRAFT WHERE APPLICABLE MUST REMAIN WITHIN DIMENSIONS | | MATERIAL NUMBER SEE CHART |
| ∇ = 0 | THIRD ANGLE PROJECTION | DRAWING B-SIZE | CUSTOMER GENERAL MARKET |
| | | SERIES 42375 | SHEET NUMBER 3 OF 35 |

| ENG. NO: A-42375-0142/0176 | | | | | |
|----------------------------|-----------------|--------------------|------|-----------------|--------------|
| HEADER NUMBER: | | 42312-0036 | | | |
| PIN NUMBER: | | 42663-ATB208 | | | |
| PIN LENGTH: L | | .530 / 13.46 | | | |
| MATING LENGTH: M | | 320 / 8.13 | | | |
| GOLD POINT: G | | .140 / 3.56 | | | |
| PC TAIL LENGTH: P | | .120 / 3.05 | | | |
| TIN: T | | .135 / 3.43 | | | |
| CKTS: | | 2-36 | | | |
| KINKS: | | NO | | | |
| VOIDED CKTS: | | NONE | | | |
| PACKAGING: | | BULK PK-40873-0041 | | | |
| CKTS | MATERIAL NUMBER | ENG NUMBER | CKTS | MATERIAL NUMBER | ENG NUMBER |
| 2 | 22-28-4024 | A-42375-0142 | 20 | 22-28-4204 | A-42375-0160 |
| 3 | 22-28-4035 | A-42375-0143 | 21 | 22-28-4214 | A-42375-0161 |
| 4 | 22-28-4044 | A-42375-0144 | 22 | 22-28-4224 | A-42375-0162 |
| 5 | 22-28-4054 | A-42375-0145 | 23 | 22-28-4234 | A-42375-0163 |
| 6 | 22-28-4064 | A-42375-0146 | 24 | 22-28-4244 | A-42375-0164 |
| 7 | 22-28-4074 | A-42375-0147 | 25 | 22-28-4254 | A-42375-0165 |
| 8 | 22-28-4084 | A-42375-0148 | 26 | 22-28-4264 | A-42375-0166 |
| 9 | 22-28-4094 | A-42375-0149 | 27 | 22-28-4274 | A-42375-0167 |
| 10 | 22-28-4104 | A-42375-0150 | 28 | 22-28-4284 | A-42375-0168 |
| 11 | 22-28-4114 | A-42375-0151 | 29 | 22-28-4294 | A-42375-0169 |
| 12 | 22-28-4124 | A-42375-0152 | 30 | 22-28-4304 | A-42375-0170 |
| 13 | 22-28-4134 | A-42375-0153 | 31 | 22-28-4314 | A-42375-0171 |
| 14 | 22-28-4144 | A-42375-0154 | 32 | 22-28-4324 | A-42375-0172 |
| 15 | 22-28-4154 | A-42375-0155 | 33 | 22-28-4334 | A-42375-0173 |
| 16 | 22-28-4164 | A-42375-0156 | 34 | 22-28-4344 | A-42375-0174 |
| 17 | 22-28-4174 | A-42375-0157 | 35 | 22-28-4354 | A-42375-0175 |
| 18 | 22-28-4184 | A-42375-0158 | 36 | 22-28-4364 | A-42375-0176 |
| 19 | 22-28-4194 | A-42375-0159 | | | |

| ENG. NO: A-42375-0177/0211 | | | | | |
|----------------------------|-----------------|--------------------|------|-----------------|--------------|
| HEADER NUMBER: | | 42312-0036 | | | |
| PIN NUMBER: | | 42663-ATB208 | | | |
| PIN LENGTH: L | | .530 / 13.46 | | | |
| MATING LENGTH: M | | 320 / 8.13 | | | |
| GOLD POINT: G | | .140 / 3.56 | | | |
| PC TAIL LENGTH: P | | .120 / 3.05 | | | |
| TIN: T | | .135 / 3.43 | | | |
| CKTS: | | 2-36 | | | |
| KINKS: | | NO | | | |
| VOIDED CKTS: | | NONE | | | |
| PACKAGING: | | BULK PK-40873-0041 | | | |
| CKTS | MATERIAL NUMBER | ENG NUMBER | CKTS | MATERIAL NUMBER | ENG NUMBER |
| 2 | 22-28-4027 | A-42375-0177 | 20 | 22-28-4207 | A-42375-0195 |
| 3 | 22-28-4037 | A-42375-0178 | 21 | 22-28-4217 | A-42375-0196 |
| 4 | 22-28-4047 | A-42375-0179 | 22 | 22-28-4227 | A-42375-0197 |
| 5 | 22-28-4057 | A-42375-0180 | 23 | 22-28-4237 | A-42375-0198 |
| 6 | 22-28-4067 | A-42375-0181 | 24 | 22-28-4247 | A-42375-0199 |
| 7 | 22-28-4077 | A-42375-0182 | 25 | 22-28-4257 | A-42375-0200 |
| 8 | 22-28-4087 | A-42375-0183 | 26 | 22-28-4267 | A-42375-0201 |
| 9 | 22-28-4097 | A-42375-0184 | 27 | 22-28-4277 | A-42375-0202 |
| 10 | 22-28-4107 | A-42375-0185 | 28 | 22-28-4287 | A-42375-0203 |
| 11 | 22-28-4117 | A-42375-0186 | 29 | 22-28-4297 | A-42375-0204 |
| 12 | 22-28-4127 | A-42375-0187 | 30 | 22-28-4307 | A-42375-0205 |
| 13 | 22-28-4137 | A-42375-0188 | 31 | 22-28-4317 | A-42375-0206 |
| 14 | 22-28-4147 | A-42375-0189 | 32 | 22-28-4327 | A-42375-0207 |
| 15 | 22-28-4157 | A-42375-0190 | 33 | 22-28-4337 | A-42375-0208 |
| 16 | 22-28-4167 | A-42375-0191 | 34 | 22-28-4347 | A-42375-0209 |
| 17 | 22-28-4177 | A-42375-0192 | 35 | 22-28-4357 | A-42375-0210 |
| 18 | 22-28-4187 | A-42375-0193 | 36 | 22-28-4367 | A-42375-0211 |
| 19 | 22-28-4197 | A-42375-0194 | | | |

| | | | | |
|---|---|--|--|---|
| SYMBOLS = 0 = 0 = 0 = 0 = 0 = 0 = 0 = 0 = 0 | THIS DRAWING CONTAINS INFORMATION THAT IS PROPRIETARY TO MOLEX ELECTRONIC TECHNOLOGIES, LLC AND SHOULD NOT BE USED WITHOUT WRITTEN PERMISSION DIMENSION UNITS: MM/IN SCALE: 1:1 | CURRENT REV DESC: GOLD LENGTH SPEC CHANGED AS MIN 2.54- MAX 5.54 FOR A-42375-0037/0071 | | |
| | GENERAL TOLERANCES (UNLESS SPECIFIED) | EC NO: 689596 DRWN: SHRUTJ 2021/09/14 CHK'D: SHRUTJ 2021/12/20 APPR: ISHWARG 2021/12/20 | | KK 100 HEADER ASSY FLAT VERTICAL BREAKAWAY |
| | 4 PLACES ± 0.0005 3 PLACES ± 0.0002 2 PLACES ± 0.0001 1 PLACE ± 0.00005 0 PLACES ± 0.00002 | INITIAL REVISION: DRWN: SCHAFFER 2003/02/11 APPR: MARGULIS 2004/02/27 | | PRODUCT CUSTOMER DRAWING |
| | ANGULAR TOL ± 0.5° DRAFT WHERE APPLICABLE MUST REMAIN WITHIN DIMENSIONS | THIRD ANGLE PROJECTION | | DOCUMENT NUMBER: SD-42375-001 DOC TYPE: PSD DOC PART: 001 REVISION: V |
| MATERIAL NUMBER: SEE CHART CUSTOMER: GENERAL MARKET SHEET NUMBER: 4 OF 35 | DRAWING: B-SIZE SERIES: 42375 | | | |

| ENG. NO: A-42375-0212/0246 | | | | | |
|----------------------------|-----------------|--------------------|------|-----------------|--------------|
| HEADER NUMBER: | | 42312-0036 | | | |
| PIN NUMBER: | | 42663-AMA154 | | | |
| PIN LENGTH: L | | .505 / 12.83 | | | |
| MATING LENGTH: M | | .295 / 7.49 | | | |
| GOLD POINT: G | | N/A | | | |
| PC TAIL LENGTH: P | | .120 / 3.05 | | | |
| TIN: T | | OVERALL | | | |
| CKTS: | | 2-36 | | | |
| KINKS: | | NO | | | |
| VOIDED CKTS: | | NONE | | | |
| PACKAGING: | | BULK PK-40873-0041 | | | |
| CKTS | MATERIAL NUMBER | ENG NUMBER | CKTS | MATERIAL NUMBER | ENG NUMBER |
| 2 | 22-28-4022 | A-42375-0212 | 20 | 22-28-4202 | A-42375-0230 |
| 3 | 22-28-4032 | A-42375-0213 | 21 | 22-28-4212 | A-42375-0231 |
| 4 | 22-28-4042 | A-42375-0214 | 22 | 22-28-4222 | A-42375-0232 |
| 5 | 22-28-4052 | A-42375-0215 | 23 | 22-28-4232 | A-42375-0233 |
| 6 | 22-28-4062 | A-42375-0216 | 24 | 22-28-4242 | A-42375-0234 |
| 7 | 22-28-4072 | A-42375-0217 | 25 | 22-28-4252 | A-42375-0235 |
| 8 | 22-28-4082 | A-42375-0218 | 26 | 22-28-4262 | A-42375-0236 |
| 9 | 22-28-4092 | A-42375-0219 | 27 | 22-28-4272 | A-42375-0237 |
| 10 | 22-28-4102 | A-42375-0220 | 28 | 22-28-4282 | A-42375-0238 |
| 11 | 22-28-4112 | A-42375-0221 | 29 | 22-28-4292 | A-42375-0239 |
| 12 | 22-28-4122 | A-42375-0222 | 30 | 22-28-4302 | A-42375-0240 |
| 13 | 22-28-4132 | A-42375-0223 | 31 | 22-28-4312 | A-42375-0241 |
| 14 | 22-28-4142 | A-42375-0224 | 32 | 22-28-4322 | A-42375-0242 |
| 15 | 22-28-4152 | A-42375-0225 | 33 | 22-28-4332 | A-42375-0243 |
| 16 | 22-28-4162 | A-42375-0226 | 34 | 22-28-4342 | A-42375-0244 |
| 17 | 22-28-4172 | A-42375-0227 | 35 | 22-28-4352 | A-42375-0245 |
| 18 | 22-28-4182 | A-42375-0228 | 36 | 22-28-4362 | A-42375-0246 |
| 19 | 22-28-4192 | A-42375-0229 | | | |

| ENG. NO: A-42375-0247/0281 | | | | | |
|----------------------------|-----------------|--------------------|------|-----------------|--------------|
| HEADER NUMBER: | | 42312-0036 | | | |
| PIN NUMBER: | | 42663-ATB208 | | | |
| PIN LENGTH: L | | .505 / 12.83 | | | |
| MATING LENGTH: M | | .295 / 7.49 | | | |
| GOLD POINT: G | | .140 / 3.56 | | | |
| PC TAIL LENGTH: P | | .120 / 3.05 | | | |
| TIN: T | | .135 / 3.43 | | | |
| CKTS: | | 2-36 | | | |
| KINKS: | | NO | | | |
| VOIDED CKTS: | | NONE | | | |
| PACKAGING: | | BULK PK-40873-0041 | | | |
| CKTS | MATERIAL NUMBER | ENG NUMBER | CKTS | MATERIAL NUMBER | ENG NUMBER |
| 2 | 22-28-4025 | A-42375-0247 | 20 | 22-28-4205 | A-42375-0265 |
| 3 | 22-28-4035 | A-42375-0248 | 21 | 22-28-4215 | A-42375-0266 |
| 4 | 22-28-4045 | A-42375-0249 | 22 | 22-28-4225 | A-42375-0267 |
| 5 | 22-28-4055 | A-42375-0250 | 23 | 22-28-4235 | A-42375-0268 |
| 6 | 22-28-4065 | A-42375-0251 | 24 | 22-28-4245 | A-42375-0269 |
| 7 | 22-28-4075 | A-42375-0252 | 25 | 22-28-4255 | A-42375-0270 |
| 8 | 22-28-4085 | A-42375-0253 | 26 | 22-28-4265 | A-42375-0271 |
| 9 | 22-28-4095 | A-42375-0254 | 27 | 22-28-4275 | A-42375-0272 |
| 10 | 22-28-4105 | A-42375-0255 | 28 | 22-28-4285 | A-42375-0273 |
| 11 | 22-28-4115 | A-42375-0256 | 29 | 22-28-4295 | A-42375-0274 |
| 12 | 22-28-4125 | A-42375-0257 | 30 | 22-28-4305 | A-42375-0275 |
| 13 | 22-28-4135 | A-42375-0258 | 31 | 22-28-4315 | A-42375-0276 |
| 14 | 22-28-4145 | A-42375-0259 | 32 | 22-28-4325 | A-42375-0277 |
| 15 | 22-28-4155 | A-42375-0260 | 33 | 22-28-4335 | A-42375-0278 |
| 16 | 22-28-4165 | A-42375-0261 | 34 | 22-28-4345 | A-42375-0279 |
| 17 | 22-28-4175 | A-42375-0262 | 35 | 22-28-4355 | A-42375-0280 |
| 18 | 22-28-4185 | A-42375-0263 | 36 | 22-28-4365 | A-42375-0281 |
| 19 | 22-28-4195 | A-42375-0264 | | | |

| SYMBOLS = 0 = 0 = 0 = 0 = 0 = 0 = 0 = 0 = 0 | THIS DRAWING CONTAINS INFORMATION THAT IS PROPRIETARY TO MOLEX ELECTRONIC TECHNOLOGIES, LLC AND SHOULD NOT BE USED WITHOUT WRITTEN PERMISSION DIMENSION UNITS: MM/IN SCALE: 1:1 | CURRENT REV DESC: GOLD LENGTH SPEC CHANGED AS MIN 2.54- MAX 5.54 FOR A-42375-0037/0071 EC NO: 689596 DRWN: SHRUTJ 2021/09/14 CHK'D: SHRUTJ 2021/12/20 APPR: ISHWARG 2021/12/20 | KK 100 HEADER ASSY FLAT VERTICAL BREAKAWAY PRODUCT CUSTOMER DRAWING | | | | | | | | | | | | | | | | | | | |
|---|---|--|---|------|------|------------|--|--|------------|--|--------|------------|------|--|-----------|------|--|------------|--|--|---|---|
| | GENERAL TOLERANCES (UNLESS SPECIFIED) <table border="1"> <tr><th></th><th>MM</th><th>INCH</th></tr> <tr><td>4 PLACES ±</td><td></td><td></td></tr> <tr><td>3 PLACES ±</td><td></td><td>± 0.01</td></tr> <tr><td>2 PLACES ±</td><td>0.25</td><td></td></tr> <tr><td>1 PLACE ±</td><td>0.38</td><td></td></tr> <tr><td>0 PLACES ±</td><td></td><td></td></tr> </table> | | | MM | INCH | 4 PLACES ± | | | 3 PLACES ± | | ± 0.01 | 2 PLACES ± | 0.25 | | 1 PLACE ± | 0.38 | | 0 PLACES ± | | | INITIAL REVISION: DRWN: SCHAFFER 2003/02/11 APPR: MARGULIS 2004/02/27 | DOCUMENT NUMBER: SD-42375-001 DOC TYPE: PSD DOC PART: 001 REVISION: V |
| | | MM | | INCH | | | | | | | | | | | | | | | | | | |
| | 4 PLACES ± | | | | | | | | | | | | | | | | | | | | | |
| 3 PLACES ± | | ± 0.01 | | | | | | | | | | | | | | | | | | | | |
| 2 PLACES ± | 0.25 | | | | | | | | | | | | | | | | | | | | | |
| 1 PLACE ± | 0.38 | | | | | | | | | | | | | | | | | | | | | |
| 0 PLACES ± | | | | | | | | | | | | | | | | | | | | | | |
| ANGULAR TOL ± 0.5° DRAFT WHERE APPLICABLE MUST REMAIN WITHIN DIMENSIONS | THIRD ANGLE PROJECTION | DRAWING: B-SIZE SERIES: 42375 | MATERIAL NUMBER: SEE CHART CUSTOMER: GENERAL MARKET SHEET NUMBER: 5 OF 35 | | | | | | | | | | | | | | | | | | | |
| DOCUMENT STATUS: P1 RELEASE DATE: 2021/12/20 12:18:33 | | | | | | | | | | | | | | | | | | | | | | |

| ENG. NO: A-42375-0282/0316 | | | | | |
|----------------------------|-----------------|--------------------|------|-----------------|--------------|
| HEADER NUMBER: | | 42312-0036 | | | |
| PIN NUMBER: | | 42663-AMB228 | | | |
| PIN LENGTH: L | | .505 / 12.83 | | | |
| MATING LENGTH: M | | .295 / 7.49 | | | |
| GOLD POINT: G | | .140 / 3.56 | | | |
| PC TAIL LENGTH: P | | .120 / 3.05 | | | |
| TIN: T | | .135 / 3.43 | | | |
| CKTS: | | 2-36 | | | |
| KINKS: | | NO | | | |
| VOIDED CKTS: | | NONE | | | |
| PACKAGING: | | BULK PK-40873-0041 | | | |
| CKTS | MATERIAL NUMBER | ENG NUMBER | CKTS | MATERIAL NUMBER | ENG NUMBER |
| 2 | 22-28-4028 | A-42375-0282 | 20 | 22-28-4208 | A-42375-0300 |
| 3 | 22-28-4038 | A-42375-0283 | 21 | 22-28-4218 | A-42375-0301 |
| 4 | 22-28-4048 | A-42375-0284 | 22 | 22-28-4228 | A-42375-0302 |
| 5 | 22-28-4058 | A-42375-0285 | 23 | 22-28-4238 | A-42375-0303 |
| 6 | 22-28-4068 | A-42375-0286 | 24 | 22-28-4248 | A-42375-0304 |
| 7 | 22-28-4078 | A-42375-0287 | 25 | 22-28-4258 | A-42375-0305 |
| 8 | 22-28-4088 | A-42375-0288 | 26 | 22-28-4268 | A-42375-0306 |
| 9 | 22-28-4098 | A-42375-0289 | 27 | 22-28-4278 | A-42375-0307 |
| 10 | 22-28-4108 | A-42375-0290 | 28 | 22-28-4288 | A-42375-0308 |
| 11 | 22-28-4118 | A-42375-0291 | 29 | 22-28-4298 | A-42375-0309 |
| 12 | 22-28-4128 | A-42375-0292 | 30 | 22-28-4308 | A-42375-0310 |
| 13 | 22-28-4138 | A-42375-0293 | 31 | 22-28-4318 | A-42375-0311 |
| 14 | 22-28-4148 | A-42375-0294 | 32 | 22-28-4328 | A-42375-0312 |
| 15 | 22-28-4158 | A-42375-0295 | 33 | 22-28-4338 | A-42375-0313 |
| 16 | 22-28-4168 | A-42375-0296 | 34 | 22-28-4348 | A-42375-0314 |
| 17 | 22-28-4178 | A-42375-0297 | 35 | 22-28-4358 | A-42375-0315 |
| 18 | 22-28-4188 | A-42375-0298 | 36 | 22-28-4368 | A-42375-0316 |
| 19 | 22-28-4198 | A-42375-0299 | | | |

| ENG. NO: A-42375-0317/0351 | | | | | |
|----------------------------|-----------------|--------------------|------|-----------------|--------------|
| HEADER NUMBER: | | 42312-0036 | | | |
| PIN NUMBER: | | 42663-ADA154 | | | |
| PIN LENGTH: L | | .465 / 11.81 | | | |
| MATING LENGTH: M | | .240 / 6.09 | | | |
| GOLD POINT: G | | N/A | | | |
| PC TAIL LENGTH: P | | .135 / 3.43 | | | |
| TIN: T | | OVERALL | | | |
| CKTS: | | 2-36 | | | |
| KINKS: | | SMES-42003 | | | |
| VOIDED CKTS: | | NONE | | | |
| PACKAGING: | | BULK PK-40873-0041 | | | |
| CKTS | MATERIAL NUMBER | ENG NUMBER | CKTS | MATERIAL NUMBER | ENG NUMBER |
| 2 | 22-28-5020 | A-42375-0317 | 20 | 22-28-5200 | A-42375-0335 |
| 3 | 22-28-5030 | A-42375-0318 | 21 | 22-28-5201 | A-42375-0336 |
| 4 | 22-28-5040 | A-42375-0319 | 22 | 22-28-5202 | A-42375-0337 |
| 5 | 22-28-5050 | A-42375-0320 | 23 | 22-28-5203 | A-42375-0338 |
| 6 | 22-28-5060 | A-42375-0321 | 24 | 22-28-5204 | A-42375-0339 |
| 7 | 22-28-5070 | A-42375-0322 | 25 | 22-28-5205 | A-42375-0340 |
| 8 | 22-28-5080 | A-42375-0323 | 26 | 22-28-5206 | A-42375-0341 |
| 9 | 22-28-5090 | A-42375-0324 | 27 | 22-28-5207 | A-42375-0342 |
| 10 | 22-28-5100 | A-42375-0325 | 28 | 22-28-5208 | A-42375-0343 |
| 11 | 22-28-5110 | A-42375-0326 | 29 | 22-28-5209 | A-42375-0344 |
| 12 | 22-28-5120 | A-42375-0327 | 30 | 22-28-5300 | A-42375-0345 |
| 13 | 22-28-5130 | A-42375-0328 | 31 | 22-28-5310 | A-42375-0346 |
| 14 | 22-28-5140 | A-42375-0329 | 32 | 22-28-5320 | A-42375-0347 |
| 15 | 22-28-5150 | A-42375-0330 | 33 | 22-28-5330 | A-42375-0348 |
| 16 | 22-28-5160 | A-42375-0331 | 34 | 22-28-5340 | A-42375-0349 |
| 17 | 22-28-5170 | A-42375-0332 | 35 | 22-28-5350 | A-42375-0350 |
| 18 | 22-28-5180 | A-42375-0333 | 36 | 22-28-5360 | A-42375-0351 |
| 19 | 22-28-5190 | A-42375-0334 | | | |

| | | | | | | | |
|--|---|--|---|--|---|--|--|
| SYMBOLS  = 0  = 0  = 0  = 0  = 0  = 0  = 0  = 0 | THIS DRAWING CONTAINS INFORMATION THAT IS PROPRIETARY TO MOLEX ELECTRONIC TECHNOLOGIES, LLC AND SHOULD NOT BE USED WITHOUT WRITTEN PERMISSION | | DIMENSION UNITS: MM/IN SCALE: 1:1 | | CURRENT REV DESC: GOLD LENGTH SPEC CHANGED AS MIN 2.54- MAX 5.54 FOR A-42375-0037/0071 | |  KK 100 HEADER ASSY FLAT VERTICAL BREAKAWAY |
| | GENERAL TOLERANCES (UNLESS SPECIFIED) | | EC NO: 689596 DRWN: SHRUTJ 2021/09/14 CHK'D: SHRUTJ 2021/12/20 APPR: ISHWARG 2021/12/20 | | PRODUCT CUSTOMER DRAWING | | |
| | 4 PLACES ± 0.125 ± 3 PLACES ± 0.25 ± 2 PLACES ± 0.38 ± 1 PLACE ± 0.75 ± 0 PLACES ± 1.5 ± | | INITIAL REVISION: DRWN: SCHAFFER 2003/02/11 APPR: MARGULIS 2004/02/27 | | DOCUMENT NUMBER: SD-42375-001 DOC TYPE: PSD DOC PART: 001 REVISION: V | | |
| | ANGULAR TOL ± 0.5° DRAFT WHERE APPLICABLE MUST REMAIN WITHIN DIMENSIONS | | THIRD ANGLE PROJECTION  | | DRAWING: B-SIZE SERIES: 42375 MATERIAL NUMBER: SEE CHART CUSTOMER: GENERAL MARKET SHEET NUMBER: 6 OF 35 | | |

| ENG. NO: A-42375-0352/0386 | | | | | |
|----------------------------|-----------------|--------------------|------|-----------------|--------------|
| HEADER NUMBER: | | 42312-0036 | | | |
| PIN NUMBER: | | 42663-ADB208 | | | |
| PIN LENGTH: L | | .465 / 11.81 | | | |
| MATING LENGTH: M | | .240 / 6.09 | | | |
| GOLD POINT: G | | .100 / 2.54 | | | |
| PC TAIL LENGTH: P | | .135 / 3.43 | | | |
| TIN: T | | .100 / 2.54 | | | |
| CKTS: | | 2-36 | | | |
| KINKS: | | SMES-42003 | | | |
| VOIDED CKTS: | | NONE | | | |
| PACKAGING: | | BULK PK-40873-0041 | | | |
| CKTS | MATERIAL NUMBER | ENG NUMBER | CKTS | MATERIAL NUMBER | ENG NUMBER |
| 2 | 22-28-5023 | A-42375-0352 | 20 | 22-28-5203 | A-42375-0370 |
| 3 | 22-28-5033 | A-42375-0353 | 21 | 22-28-5213 | A-42375-0371 |
| 4 | 22-28-5043 | A-42375-0354 | 22 | 22-28-5223 | A-42375-0372 |
| 5 | 22-28-5053 | A-42375-0355 | 23 | 22-28-5233 | A-42375-0373 |
| 6 | 22-28-5063 | A-42375-0356 | 24 | 22-28-5243 | A-42375-0374 |
| 7 | 22-28-5073 | A-42375-0357 | 25 | 22-28-5253 | A-42375-0375 |
| 8 | 22-28-5083 | A-42375-0358 | 26 | 22-28-5263 | A-42375-0376 |
| 9 | 22-28-5093 | A-42375-0359 | 27 | 22-28-5273 | A-42375-0377 |
| 10 | 22-28-5103 | A-42375-0360 | 28 | 22-28-5283 | A-42375-0378 |
| 11 | 22-28-5113 | A-42375-0361 | 29 | 22-28-5293 | A-42375-0379 |
| 12 | 22-28-5123 | A-42375-0362 | 30 | 22-28-5303 | A-42375-0380 |
| 13 | 22-28-5133 | A-42375-0363 | 31 | 22-28-5313 | A-42375-0381 |
| 14 | 22-28-5143 | A-42375-0364 | 32 | 22-28-5323 | A-42375-0382 |
| 15 | 22-28-5153 | A-42375-0365 | 33 | 22-28-5333 | A-42375-0383 |
| 16 | 22-28-5163 | A-42375-0366 | 34 | 22-28-5343 | A-42375-0384 |
| 17 | 22-28-5173 | A-42375-0367 | 35 | 22-28-5353 | A-42375-0385 |
| 18 | 22-28-5183 | A-42375-0368 | 36 | 22-28-5363 | A-42375-0386 |
| 19 | 22-28-5193 | A-42375-0369 | | | |

| ENG. NO: A-42375-0387/0421 | | | | | |
|----------------------------|-----------------|--------------------|------|-----------------|--------------|
| HEADER NUMBER: | | 42312-0036 | | | |
| PIN NUMBER: | | 42663-ADB228 | | | |
| PIN LENGTH: L | | .465 / 11.81 | | | |
| MATING LENGTH: M | | .240 / 6.09 | | | |
| GOLD POINT: G | | .100 / 2.54 | | | |
| PC TAIL LENGTH: P | | .135 / 3.43 | | | |
| TIN: T | | .100 / 2.54 | | | |
| CKTS: | | 2-36 | | | |
| KINKS: | | SMES-42003 | | | |
| VOIDED CKTS: | | NONE | | | |
| PACKAGING: | | BULK PK-40873-0041 | | | |
| CKTS | MATERIAL NUMBER | ENG NUMBER | CKTS | MATERIAL NUMBER | ENG NUMBER |
| 2 | 22-28-5026 | A-42375-0387 | 20 | 22-28-5206 | A-42375-0405 |
| 3 | 22-28-5036 | A-42375-0388 | 21 | 22-28-5216 | A-42375-0406 |
| 4 | 22-28-5046 | A-42375-0389 | 22 | 22-28-5226 | A-42375-0407 |
| 5 | 22-28-5056 | A-42375-0390 | 23 | 22-28-5236 | A-42375-0408 |
| 6 | 22-28-5066 | A-42375-0391 | 24 | 22-28-5246 | A-42375-0409 |
| 7 | 22-28-5076 | A-42375-0392 | 25 | 22-28-5256 | A-42375-0410 |
| 8 | 22-28-5086 | A-42375-0393 | 26 | 22-28-5266 | A-42375-0411 |
| 9 | 22-28-5096 | A-42375-0394 | 27 | 22-28-5276 | A-42375-0412 |
| 10 | 22-28-5106 | A-42375-0395 | 28 | 22-28-5286 | A-42375-0413 |
| 11 | 22-28-5116 | A-42375-0396 | 29 | 22-28-5296 | A-42375-0414 |
| 12 | 22-28-5126 | A-42375-0397 | 30 | 22-28-5306 | A-42375-0415 |
| 13 | 22-28-5136 | A-42375-0398 | 31 | 22-28-5316 | A-42375-0416 |
| 14 | 22-28-5146 | A-42375-0399 | 32 | 22-28-5326 | A-42375-0417 |
| 15 | 22-28-5156 | A-42375-0400 | 33 | 22-28-5336 | A-42375-0418 |
| 16 | 22-28-5166 | A-42375-0401 | 34 | 22-28-5346 | A-42375-0419 |
| 17 | 22-28-5176 | A-42375-0402 | 35 | 22-28-5356 | A-42375-0420 |
| 18 | 22-28-5186 | A-42375-0403 | 36 | 22-28-5366 | A-42375-0421 |
| 19 | 22-28-5196 | A-42375-0404 | | | |

| SYMBOLS  = 0  = 0  = 0  = 0  = 0  = 0  = 0  = 0 | THIS DRAWING CONTAINS INFORMATION THAT IS PROPRIETARY TO MOLEX ELECTRONIC TECHNOLOGIES, LLC AND SHOULD NOT BE USED WITHOUT WRITTEN PERMISSION DIMENSION UNITS: MM/IN SCALE: 1:1 | CURRENT REV DESC: GOLD LENGTH SPEC CHANGED AS MIN 2.54- MAX 5.54 FOR A-42375-0037/0071 EC NO: 689596 DRWN: SHRUTJ 2021/09/14 CHK'D: SHRUTJ 2021/12/20 APPR: ISHWARG 2021/12/20 |  KK 100 HEADER ASSY FLAT VERTICAL BREAKAWAY PRODUCT CUSTOMER DRAWING | | | | | | | | | | | | | | | | | | | |
|--|--|--|--|------|------|----------|---|---|----------|---|--------|----------|--------|---|---------|--------|---|----------|---|---|---|---|
| | GENERAL TOLERANCES (UNLESS SPECIFIED) <table border="1"> <tr><th></th><th>MM</th><th>INCH</th></tr> <tr><td>4 PLACES</td><td>±</td><td>±</td></tr> <tr><td>3 PLACES</td><td>±</td><td>± 0.01</td></tr> <tr><td>2 PLACES</td><td>± 0.25</td><td>±</td></tr> <tr><td>1 PLACE</td><td>± 0.38</td><td>±</td></tr> <tr><td>0 PLACES</td><td>±</td><td>±</td></tr> </table> | | | MM | INCH | 4 PLACES | ± | ± | 3 PLACES | ± | ± 0.01 | 2 PLACES | ± 0.25 | ± | 1 PLACE | ± 0.38 | ± | 0 PLACES | ± | ± | INITIAL REVISION: DRWN: SCHAFFER 2003/02/11 APPR: MARGULIS 2004/02/27 | DOCUMENT NUMBER: SD-42375-001 DOC TYPE: PSD DOC PART: 001 REVISION: V |
| | | MM | | INCH | | | | | | | | | | | | | | | | | | |
| | 4 PLACES | ± | | ± | | | | | | | | | | | | | | | | | | |
| 3 PLACES | ± | ± 0.01 | | | | | | | | | | | | | | | | | | | | |
| 2 PLACES | ± 0.25 | ± | | | | | | | | | | | | | | | | | | | | |
| 1 PLACE | ± 0.38 | ± | | | | | | | | | | | | | | | | | | | | |
| 0 PLACES | ± | ± | | | | | | | | | | | | | | | | | | | | |
| ANGULAR TOL ± 0.5° DRAFT WHERE APPLICABLE MUST REMAIN WITHIN DIMENSIONS | THIRD ANGLE PROJECTION  | DRAWING: B-SIZE SERIES: 42375 MATERIAL NUMBER: SEE CHART CUSTOMER: GENERAL MARKET SHEET NUMBER: 7 OF 35 | | | | | | | | | | | | | | | | | | | | |
| DOCUMENT STATUS: P1 RELEASE DATE: 2021/12/20 12:18:33 | | | | | | | | | | | | | | | | | | | | | | |

| ENG. NO: A-42375-0422/0456 | | | | | |
|----------------------------|-----------------|--------------------|------|-----------------|--------------|
| HEADER NUMBER: | | 42312-0036 | | | |
| PIN NUMBER: | | 42663-AYA154 | | | |
| PIN LENGTH: L | | .545 / 13.84 | | | |
| MATING LENGTH: M | | .320 / 8.13 | | | |
| GOLD POINT: G | | N/A | | | |
| PC TAIL LENGTH: P | | .135 / 3.43 | | | |
| TIN: T | | OVERALL | | | |
| CKTS: | | 2-36 | | | |
| KINKS: | | SMES-42003 | | | |
| VOIDED CKTS: | | NONE | | | |
| PACKAGING: | | BULK PK-40873-0041 | | | |
| CKTS | MATERIAL NUMBER | ENG NUMBER | CKTS | MATERIAL NUMBER | ENG NUMBER |
| 2 | 22-28-5021 | A-42375-0422 | 20 | 22-28-5201 | A-42375-0440 |
| 3 | 22-28-5031 | A-42375-0423 | 21 | 22-28-5211 | A-42375-0441 |
| 4 | 22-28-5041 | A-42375-0424 | 22 | 22-28-5221 | A-42375-0442 |
| 5 | 22-28-5051 | A-42375-0425 | 23 | 22-28-5231 | A-42375-0443 |
| 6 | 22-28-5061 | A-42375-0426 | 24 | 22-28-5241 | A-42375-0444 |
| 7 | 22-28-5071 | A-42375-0427 | 25 | 22-28-5251 | A-42375-0445 |
| 8 | 22-28-5081 | A-42375-0428 | 26 | 22-28-5261 | A-42375-0446 |
| 9 | 22-28-5091 | A-42375-0429 | 27 | 22-28-5271 | A-42375-0447 |
| 10 | 22-28-5101 | A-42375-0430 | 28 | 22-28-5281 | A-42375-0448 |
| 11 | 22-28-5111 | A-42375-0431 | 29 | 22-28-5291 | A-42375-0449 |
| 12 | 22-28-5121 | A-42375-0432 | 30 | 22-28-5301 | A-42375-0450 |
| 13 | 22-28-5131 | A-42375-0433 | 31 | 22-28-5311 | A-42375-0451 |
| 14 | 22-28-5141 | A-42375-0434 | 32 | 22-28-5321 | A-42375-0452 |
| 15 | 22-28-5151 | A-42375-0435 | 33 | 22-28-5331 | A-42375-0453 |
| 16 | 22-28-5161 | A-42375-0436 | 34 | 22-28-5341 | A-42375-0454 |
| 17 | 22-28-5171 | A-42375-0437 | 35 | 22-28-5351 | A-42375-0455 |
| 18 | 22-28-5181 | A-42375-0438 | 36 | 22-28-5361 | A-42375-0456 |
| 19 | 22-28-5191 | A-42375-0439 | | | |

| ENG. NO: A-42375-0457/0491 | | | | | |
|----------------------------|-----------------|--------------------|------|-----------------|--------------|
| HEADER NUMBER: | | 42312-0036 | | | |
| PIN NUMBER: | | 42663-ADB208 | | | |
| PIN LENGTH: L | | .545 / 13.84 | | | |
| MATING LENGTH: M | | .320 / 8.13 | | | |
| GOLD POINT: G | | .140 / 3.56 | | | |
| PC TAIL LENGTH: P | | .135 / 3.43 | | | |
| TIN: T | | .135 / 3.43 | | | |
| CKTS: | | 2-36 | | | |
| KINKS: | | SMES-42003 | | | |
| VOIDED CKTS: | | NONE | | | |
| PACKAGING: | | BULK PK-40873-0041 | | | |
| CKTS | MATERIAL NUMBER | ENG NUMBER | CKTS | MATERIAL NUMBER | ENG NUMBER |
| 2 | 22-28-5024 | A-42375-0457 | 20 | 22-28-5204 | A-42375-0475 |
| 3 | 22-28-5034 | A-42375-0458 | 21 | 22-28-5214 | A-42375-0476 |
| 4 | 22-28-5044 | A-42375-0459 | 22 | 22-28-5224 | A-42375-0477 |
| 5 | 22-28-5054 | A-42375-0460 | 23 | 22-28-5234 | A-42375-0478 |
| 6 | 22-28-5064 | A-42375-0461 | 24 | 22-28-5244 | A-42375-0479 |
| 7 | 22-28-5074 | A-42375-0462 | 25 | 22-28-5254 | A-42375-0480 |
| 8 | 22-28-5084 | A-42375-0463 | 26 | 22-28-5264 | A-42375-0481 |
| 9 | 22-28-5094 | A-42375-0464 | 27 | 22-28-5274 | A-42375-0482 |
| 10 | 22-28-5104 | A-42375-0365 | 28 | 22-28-5284 | A-42375-0483 |
| 11 | 22-28-5114 | A-42375-0466 | 29 | 22-28-5294 | A-42375-044 |
| 12 | 22-28-5124 | A-42375-0467 | 30 | 22-28-5304 | A-42375-0485 |
| 13 | 22-28-5134 | A-42375-0468 | 31 | 22-28-5314 | A-42375-0486 |
| 14 | 22-28-5144 | A-42375-0469 | 32 | 22-28-5324 | A-42375-0487 |
| 15 | 22-28-5154 | A-42375-0470 | 33 | 22-28-5334 | A-42375-0488 |
| 16 | 22-28-5164 | A-42375-0471 | 34 | 22-28-5344 | A-42375-0489 |
| 17 | 22-28-5174 | A-42375-0472 | 35 | 22-28-5354 | A-42375-0490 |
| 18 | 22-28-5184 | A-42375-0473 | 36 | 22-28-5364 | A-42375-0491 |
| 19 | 22-28-5194 | A-42375-0474 | | | |

| | | | |
|---------|---|---------|--|
| SYMBOLS | THIS DRAWING CONTAINS INFORMATION THAT IS PROPRIETARY TO MOLEX ELECTRONIC TECHNOLOGIES, LLC AND SHOULD NOT BE USED WITHOUT WRITTEN PERMISSION | | |
| | DIMENSION UNITS | SCALE | CURRENT REV DESC: GOLD LENGTH SPEC CHANGED AS MIN 2.54- MAX 5.54 FOR A-42375-0037/0071 |
| ▽ = 0 | MM/IN | 1:1 |  KK 100 HEADER ASSY FLAT VERTICAL BREAKAWAY |
| ▽ = 0 | GENERAL TOLERANCES (UNLESS SPECIFIED) | | |
| ▽ = 0 | | | EC NO: 689596 DRWN: SHRUTJ 2021/09/14 CHK'D: SHRUTJ 2021/12/20 APPR: ISHWARG 2021/12/20 |
| ▽ = 0 | 4 PLACES ± | ± | |
| ▽ = 0 | 3 PLACES ± | ± 0.01 | PRODUCT CUSTOMER DRAWING DOCUMENT NUMBER: SD-42375-001 DOC TYPE: PSD DOC PART: 001 REVISION: V |
| ▽ = 0 | 2 PLACES ± | ± 0.25 | |
| ▽ = 0 | 1 PLACE ± | ± 0.38 | INITIAL REVISION: DRWN: SCHAFFER 2003/02/11 APPR: MARGULIS 2004/02/27 |
| ▽ = 0 | 0 PLACES ± | ± | |
| ▽ = 0 | ANGULAR TOL | ± 0.5° | MATERIAL NUMBER: SEE CHART CUSTOMER: GENERAL MARKET SHEET NUMBER: 8 OF 35 |
| ▽ = 0 | DRAFT WHERE APPLICABLE MUST REMAIN WITHIN DIMENSIONS | | |
| ▽ = 0 | THIRD ANGLE PROJECTION | DRAWING | SERIES: 42375 |
| ▽ = 0 | B-SIZE | | |

| ENG. NO: A-42375-0492/0526 | | | | | |
|----------------------------|-----------------|--------------------|------|-----------------|--------------|
| HEADER NUMBER: | | 42312-0036 | | | |
| PIN NUMBER: | | 42663-AYB228 | | | |
| PIN LENGTH: L | | .545 / 13.84 | | | |
| MATING LENGTH: M | | .320 / 8.13 | | | |
| GOLD POINT: G | | 140 / 3.56 | | | |
| PC TAIL LENGTH: P | | .135 / 3.43 | | | |
| TIN: T | | .135 / 3.43 | | | |
| CKTS: | | 2-36 | | | |
| KINKS: | | SMES-42003 | | | |
| VOIDED CKTS: | | NONE | | | |
| PACKAGING: | | BULK PK-40873-0041 | | | |
| CKTS | MATERIAL NUMBER | ENG NUMBER | CKTS | MATERIAL NUMBER | ENG NUMBER |
| 2 | 22-28-5027 | A-42375-0492 | 20 | 22-28-5207 | A-42375-0510 |
| 3 | 22-28-5037 | A-42375-0493 | 21 | 22-28-5217 | A-42375-0511 |
| 4 | 22-28-5047 | A-42375-0494 | 22 | 22-28-5227 | A-42375-0512 |
| 5 | 22-28-5057 | A-42375-0495 | 23 | 22-28-5237 | A-42375-0513 |
| 6 | 22-28-5067 | A-42375-0496 | 24 | 22-28-5247 | A-42375-0514 |
| 7 | 22-28-5077 | A-42375-0497 | 25 | 22-28-5257 | A-42375-0515 |
| 8 | 22-28-5087 | A-42375-0498 | 26 | 22-28-5267 | A-42375-0516 |
| 9 | 22-28-5097 | A-42375-0499 | 27 | 22-28-5277 | A-42375-0517 |
| 10 | 22-28-5107 | A-42375-0500 | 28 | 22-28-5287 | A-42375-0518 |
| 11 | 22-28-5117 | A-42375-0501 | 29 | 22-28-5297 | A-42375-0519 |
| 12 | 22-28-5127 | A-42375-0502 | 30 | 22-28-5307 | A-42375-0520 |
| 13 | 22-28-5137 | A-42375-0503 | 31 | 22-28-5317 | A-42375-0521 |
| 14 | 22-28-5147 | A-42375-0504 | 32 | 22-28-5327 | A-42375-0522 |
| 15 | 22-28-5157 | A-42375-0505 | 33 | 22-28-5337 | A-42375-0523 |
| 16 | 22-28-5167 | A-42375-0506 | 34 | 22-28-5347 | A-42375-0524 |
| 17 | 22-28-5177 | A-42375-0507 | 35 | 22-28-5357 | A-42375-0525 |
| 18 | 22-28-5187 | A-42375-0508 | 36 | 22-28-5367 | A-42375-0526 |
| 19 | 22-28-5197 | A-42375-0509 | | | |

| ENG. NO: A-42375-0527/0561 | | | | | |
|----------------------------|-----------------|--------------------|------|-----------------|--------------|
| HEADER NUMBER: | | 42312-0036 | | | |
| PIN NUMBER: | | 42663-ARA154 | | | |
| PIN LENGTH: L | | .520 / 13.21 | | | |
| MATING LENGTH: M | | .295 / 7.49 | | | |
| GOLD POINT: G | | N/A | | | |
| PC TAIL LENGTH: P | | .135 / 3.43 | | | |
| TIN: T | | OVERALL | | | |
| CKTS: | | 2-36 | | | |
| KINKS: | | SMES-42003 | | | |
| VOIDED CKTS: | | NONE | | | |
| PACKAGING: | | BULK PK-40873-0041 | | | |
| CKTS | MATERIAL NUMBER | ENG NUMBER | CKTS | MATERIAL NUMBER | ENG NUMBER |
| 2 | 22-28-5022 | A-42375-0527 | 20 | 22-28-5202 | A-42375-0545 |
| 3 | 22-28-5032 | A-42375-0528 | 21 | 22-28-5212 | A-42375-0546 |
| 4 | 22-28-5042 | A-42375-0529 | 22 | 22-28-5222 | A-42375-0547 |
| 5 | 22-28-5052 | A-42375-0530 | 23 | 22-28-5232 | A-42375-0548 |
| 6 | 22-28-5062 | A-42375-0531 | 24 | 22-28-5242 | A-42375-0549 |
| 7 | 22-28-5072 | A-42375-0532 | 25 | 22-28-5252 | A-42375-0550 |
| 8 | 22-28-5082 | A-42375-0533 | 26 | 22-28-5262 | A-42375-0551 |
| 9 | 22-28-5092 | A-42375-0534 | 27 | 22-28-5272 | A-42375-0552 |
| 10 | 22-28-5102 | A-42375-0435 | 28 | 22-28-5282 | A-42375-0553 |
| 11 | 22-28-5112 | A-42375-0536 | 29 | 22-28-5292 | A-42375-0554 |
| 12 | 22-28-5122 | A-42375-0537 | 30 | 22-28-5302 | A-42375-0555 |
| 13 | 22-28-5132 | A-42375-0538 | 31 | 22-28-5312 | A-42375-0556 |
| 14 | 22-28-5142 | A-42375-0539 | 32 | 22-28-5322 | A-42375-0557 |
| 15 | 22-28-5152 | A-42375-0540 | 33 | 22-28-5332 | A-42375-0558 |
| 16 | 22-28-5162 | A-42375-0541 | 34 | 22-28-5342 | A-42375-0559 |
| 17 | 22-28-5172 | A-42375-0542 | 35 | 22-28-5352 | A-42375-0560 |
| 18 | 22-28-5182 | A-42375-0543 | 36 | 22-28-5362 | A-42375-0561 |
| 19 | 22-28-5192 | A-42375-0544 | | | |

| | | | |
|---------|---|---------|--|
| SYMBOLS | THIS DRAWING CONTAINS INFORMATION THAT IS PROPRIETARY TO MOLEX ELECTRONIC TECHNOLOGIES, LLC AND SHOULD NOT BE USED WITHOUT WRITTEN PERMISSION | | |
| | DIMENSION UNITS | SCALE | CURRENT REV DESC: GOLD LENGTH SPEC CHANGED AS MIN 2.54- MAX 5.54 FOR A-42375-0037/0071 |
| ▽ = 0 | MM/IN | 1:1 |  KK 100 HEADER ASSY FLAT VERTICAL BREAKAWAY |
| ▽ = 0 | GENERAL TOLERANCES (UNLESS SPECIFIED) | | |
| ▽ = 0 | | | EC NO: 689596 DRWN: SHRUTJ 2021/09/14 CHK'D: SHRUTJ 2021/12/20 APPR: ISHWARG 2021/12/20 |
| ▽ = 0 | 4 PLACES ± | ± | |
| ▽ = 0 | 3 PLACES ± | ± 0.01 | PRODUCT CUSTOMER DRAWING DOCUMENT NUMBER: SD-42375-001 DOC TYPE: PSD DOC PART: 001 REVISION: V |
| ▽ = 0 | 2 PLACES ± | ± 0.25 | |
| ▽ = 0 | 1 PLACE ± | ± 0.38 | INITIAL REVISION: DRWN: SCHAFFER 2003/02/11 APPR: MARGULIS 2004/02/27 |
| ▽ = 0 | 0 PLACES ± | ± | |
| ▽ = 0 | ANGULAR TOL | ± 0.5° | MATERIAL NUMBER: SEE CHART CUSTOMER: GENERAL MARKET SHEET NUMBER: 9 OF 35 |
| ▽ = 0 | DRAFT WHERE APPLICABLE MUST REMAIN WITHIN DIMENSIONS | | |
| ▽ = 0 | THIRD ANGLE PROJECTION | DRAWING | SERIES: 42375 B-SIZE |
| ▽ = 0 | | | |

| ENG. NO: A-42375-0562/0596 | | | | | |
|----------------------------|-----------------|--------------------|------|-----------------|--------------|
| HEADER NUMBER: | | 42312-0036 | | | |
| PIN NUMBER: | | 42663-ARB208 | | | |
| PIN LENGTH: L | | .520 / 13.21 | | | |
| MATING LENGTH: M | | .295 / 7.49 | | | |
| GOLD POINT: G | | 140 / 3.56 | | | |
| PC TAIL LENGTH: P | | .135 / 3.43 | | | |
| TIN: T | | .135 / 3.43 | | | |
| CKTS: | | 2-36 | | | |
| KINKS: | | SMES-42003 | | | |
| VOIDED CKTS: | | NONE | | | |
| PACKAGING: | | BULK PK-40873-0041 | | | |
| CKTS | MATERIAL NUMBER | ENG NUMBER | CKTS | MATERIAL NUMBER | ENG NUMBER |
| 2 | 22-28-5025 | A-42375-0562 | 20 | 22-28-5205 | A-42375-0580 |
| 3 | 22-28-5035 | A-42375-0563 | 21 | 22-28-5215 | A-42375-0581 |
| 4 | 22-28-5045 | A-42375-0564 | 22 | 22-28-5225 | A-42375-0582 |
| 5 | 22-28-5055 | A-42375-0565 | 23 | 22-28-5235 | A-42375-0583 |
| 6 | 22-28-5065 | A-42375-0566 | 24 | 22-28-5245 | A-42375-0584 |
| 7 | 22-28-5075 | A-42375-0567 | 25 | 22-28-5255 | A-42375-0585 |
| 8 | 22-28-5085 | A-42375-0568 | 26 | 22-28-5265 | A-42375-0586 |
| 9 | 22-28-5095 | A-42375-0569 | 27 | 22-28-5275 | A-42375-0587 |
| 10 | 22-28-5105 | A-42375-0570 | 28 | 22-28-5285 | A-42375-0588 |
| 11 | 22-28-5115 | A-42375-0571 | 29 | 22-28-5295 | A-42375-0589 |
| 12 | 22-28-5125 | A-42375-0572 | 30 | 22-28-5305 | A-42375-0590 |
| 13 | 22-28-5135 | A-42375-0573 | 31 | 22-28-5315 | A-42375-0591 |
| 14 | 22-28-5145 | A-42375-0574 | 32 | 22-28-5325 | A-42375-0592 |
| 15 | 22-28-5155 | A-42375-0575 | 33 | 22-28-5335 | A-42375-0593 |
| 16 | 22-28-5165 | A-42375-0576 | 34 | 22-28-5345 | A-42375-0594 |
| 17 | 22-28-5175 | A-42375-0577 | 35 | 22-28-5355 | A-42375-0595 |
| 18 | 22-28-5185 | A-42375-0578 | 36 | 22-28-5365 | A-42375-0596 |
| 19 | 22-28-5195 | A-42375-0579 | | | |

| ENG. NO: A-42375-0597/0631 | | | | | |
|----------------------------|-----------------|--------------------|------|-----------------|--------------|
| HEADER NUMBER: | | 42312-0036 | | | |
| PIN NUMBER: | | 42663-ARB208 | | | |
| PIN LENGTH: L | | .520 / 13.21 | | | |
| MATING LENGTH: M | | .295 / 7.49 | | | |
| GOLD POINT: G | | 140 / 3.56 | | | |
| PC TAIL LENGTH: P | | .135 / 3.43 | | | |
| TIN: T | | .135 / 3.43 | | | |
| CKTS: | | 2-36 | | | |
| KINKS: | | SMES-42003 | | | |
| VOIDED CKTS: | | NONE | | | |
| PACKAGING: | | BULK PK-40873-0041 | | | |
| CKTS | MATERIAL NUMBER | ENG NUMBER | CKTS | MATERIAL NUMBER | ENG NUMBER |
| 2 | 22-28-5028 | A-42375-0597 | 20 | 22-28-5208 | A-42375-0615 |
| 3 | 22-28-5038 | A-42375-0598 | 21 | 22-28-5218 | A-42375-0616 |
| 4 | 22-28-5048 | A-42375-0599 | 22 | 22-28-5228 | A-42375-0617 |
| 5 | 22-28-5058 | A-42375-0600 | 23 | 22-28-5238 | A-42375-0618 |
| 6 | 22-28-5068 | A-42375-0601 | 24 | 22-28-5248 | A-42375-0619 |
| 7 | 22-28-5078 | A-42375-0602 | 25 | 22-28-5258 | A-42375-0620 |
| 8 | 22-28-5088 | A-42375-0603 | 26 | 22-28-5268 | A-42375-0621 |
| 9 | 22-28-5098 | A-42375-0604 | 27 | 22-28-5278 | A-42375-0622 |
| 10 | 22-28-5108 | A-42375-0605 | 28 | 22-28-5288 | A-42375-0623 |
| 11 | 22-28-5118 | A-42375-0606 | 29 | 22-28-5298 | A-42375-0624 |
| 12 | 22-28-5128 | A-42375-0607 | 30 | 22-28-5308 | A-42375-0625 |
| 13 | 22-28-5138 | A-42375-0608 | 31 | 22-28-5318 | A-42375-0626 |
| 14 | 22-28-5148 | A-42375-0609 | 32 | 22-28-5328 | A-42375-0627 |
| 15 | 22-28-5158 | A-42375-0610 | 33 | 22-28-5338 | A-42375-0628 |
| 16 | 22-28-5168 | A-42375-0611 | 34 | 22-28-5348 | A-42375-0629 |
| 17 | 22-28-5178 | A-42375-0612 | 35 | 22-28-5358 | A-42375-0630 |
| 18 | 22-28-5188 | A-42375-0613 | 36 | 22-28-5368 | A-42375-0631 |
| 19 | 22-28-5198 | A-42375-0614 | | | |

| SYMBOLS = 0 = 0 = 0 = 0 = 0 = 0 = 0 = 0 = 0 | THIS DRAWING CONTAINS INFORMATION THAT IS PROPRIETARY TO MOLEX ELECTRONIC TECHNOLOGIES, LLC AND SHOULD NOT BE USED WITHOUT WRITTEN PERMISSION DIMENSION UNITS: MM/IN SCALE: 1:1 | CURRENT REV DESC: GOLD LENGTH SPEC CHANGED AS MIN 2.54- MAX 5.54 FOR A-42375-0037/0071 EC NO: 689596 DRWN: SHRUTJ 2021/09/14 CHK'D: SHRUTJ 2021/12/20 APPR: ISHWARG 2021/12/20 | KK 100 HEADER ASSY FLAT VERTICAL BREAKAWAY PRODUCT CUSTOMER DRAWING | | | | | | | | | | | | | | | | | | | |
|---|---|--|--|------|------|------------|--|--|------------|--|--------|------------|------|--|-----------|------|--|------------|--|--|---|---|
| | GENERAL TOLERANCES (UNLESS SPECIFIED) <table border="1"> <tr> <th></th> <th>MM</th> <th>INCH</th> </tr> <tr> <td>4 PLACES ±</td> <td></td> <td></td> </tr> <tr> <td>3 PLACES ±</td> <td></td> <td>± 0.01</td> </tr> <tr> <td>2 PLACES ±</td> <td>0.25</td> <td></td> </tr> <tr> <td>1 PLACE ±</td> <td>0.38</td> <td></td> </tr> <tr> <td>0 PLACES ±</td> <td></td> <td></td> </tr> </table> | | | MM | INCH | 4 PLACES ± | | | 3 PLACES ± | | ± 0.01 | 2 PLACES ± | 0.25 | | 1 PLACE ± | 0.38 | | 0 PLACES ± | | | INITIAL REVISION: DRWN: SCHAFFER 2003/02/11 APPR: MARGULIS 2004/02/27 | DOCUMENT NUMBER: SD-42375-001 DOC TYPE: PSD DOC PART: 001 REVISION: V |
| | | MM | | INCH | | | | | | | | | | | | | | | | | | |
| | 4 PLACES ± | | | | | | | | | | | | | | | | | | | | | |
| 3 PLACES ± | | ± 0.01 | | | | | | | | | | | | | | | | | | | | |
| 2 PLACES ± | 0.25 | | | | | | | | | | | | | | | | | | | | | |
| 1 PLACE ± | 0.38 | | | | | | | | | | | | | | | | | | | | | |
| 0 PLACES ± | | | | | | | | | | | | | | | | | | | | | | |
| ANGULAR TOL ± 0.5° DRAFT WHERE APPLICABLE MUST REMAIN WITHIN DIMENSIONS | THIRD ANGLE PROJECTION | DRAWING: B-SIZE SERIES: 42375 | MATERIAL NUMBER: SEE CHART CUSTOMER: GENERAL MARKET SHEET NUMBER: 10 OF 35 | | | | | | | | | | | | | | | | | | | |
| DOCUMENT STATUS: P1 RELEASE DATE: 2021/12/20 12:18:33 | | | | | | | | | | | | | | | | | | | | | | |

| ENG. NO: A-42375-0667/0699 | | | | | |
|----------------------------|-----------------|--------------------|------|-----------------|--------------|
| HEADER NUMBER: | | 42312-0036 | | | |
| PIN NUMBER: | | 42663-ABB208 | | | |
| PIN LENGTH: L | | .455 / 11.56 | | | |
| MATING LENGTH: M | | .240 / 6.09 | | | |
| GOLD POINT: G | | .100 / 2.54 | | | |
| PC TAIL LENGTH: P | | .125 / 3.18 | | | |
| TIN: T | | .100 / 2.54 | | | |
| CKTS: | | 4-36 | | | |
| KINKS: | | NO | | | |
| VOIDED CKTS: | | 4 | | | |
| PACKAGING: | | BULK PK-40873-0041 | | | |
| CKTS | MATERIAL NUMBER | ENG NUMBER | CKTS | MATERIAL NUMBER | ENG NUMBER |
| 2 | | | 20 | 42375-0683 | A-42375-0683 |
| 3 | | | 21 | 42375-0684 | A-42375-0684 |
| 4 | 42375-0667 | A-42375-0667 | 22 | 42375-0685 | A-42375-0685 |
| 5 | 42375-0668 | A-42375-0668 | 23 | 42375-0686 | A-42375-0686 |
| 6 | 22-30-3060 | A-42375-0669 | 24 | 42375-0687 | A-42375-0687 |
| 7 | 42375-0670 | A-42375-0670 | 25 | 42375-0688 | A-42375-0688 |
| 8 | 42375-0671 | A-42375-0671 | 26 | 42375-0689 | A-42375-0689 |
| 9 | 42375-0672 | A-42375-0672 | 27 | 42375-0690 | A-42375-0690 |
| 10 | 42375-0673 | A-42375-0673 | 28 | 42375-0691 | A-42375-0691 |
| 11 | 42375-0674 | A-42375-0674 | 29 | 42375-0692 | A-42375-0692 |
| 12 | 22-30-3120 | A-42375-0675 | 30 | 42375-0693 | A-42375-0693 |
| 13 | 42375-0676 | A-42375-0676 | 31 | 42375-0694 | A-42375-0694 |
| 14 | 42375-0677 | A-42375-0677 | 32 | 42375-0695 | A-42375-0695 |
| 15 | 42375-0678 | A-42375-0678 | 33 | 42375-0696 | A-42375-0696 |
| 16 | 42375-0679 | A-42375-0679 | 34 | 42375-0697 | A-42375-0697 |
| 17 | 42375-0680 | A-42375-0680 | 35 | 42375-0698 | A-42375-0698 |
| 18 | 42375-0681 | A-42375-0681 | 36 | 42375-0699 | A-42375-0699 |
| 19 | 42375-0682 | A-42375-0682 | | | |

| ENG. NO: A-42375-0700/0732 | | | | | |
|----------------------------|-----------------|--------------------|------|-----------------|--------------|
| HEADER NUMBER: | | 42312-0036 | | | |
| PIN NUMBER: | | 42663-ADB208 | | | |
| PIN LENGTH: L | | .465 / 11.81 | | | |
| MATING LENGTH: M | | .240 / 6.09 | | | |
| GOLD POINT: G | | .100 / 2.54 | | | |
| PC TAIL LENGTH: P | | .135 / 3.43 | | | |
| TIN: T | | .100 / 2.54 | | | |
| CKTS: | | 4-36 | | | |
| KINKS: | | SMES-42003 | | | |
| VOIDED CKTS: | | 4 | | | |
| PACKAGING: | | BULK PK-40873-0041 | | | |
| CKTS | MATERIAL NUMBER | ENG NUMBER | CKTS | MATERIAL NUMBER | ENG NUMBER |
| 2 | | | 20 | 42375-0716 | A-42375-0716 |
| 3 | | | 21 | 42375-0717 | A-42375-0717 |
| 4 | 42375-0700 | A-42375-0700 | 22 | 42375-0718 | A-42375-0718 |
| 5 | 42375-0701 | A-42375-0701 | 23 | 42375-0719 | A-42375-0719 |
| 6 | 22-30-3061 | A-42375-0702 | 24 | 42375-0720 | A-42375-0720 |
| 7 | 42375-0703 | A-42375-0703 | 25 | 42375-0721 | A-42375-0721 |
| 8 | 42375-0704 | A-42375-0704 | 26 | 42375-0722 | A-42375-0722 |
| 9 | 42375-0705 | A-42375-0705 | 27 | 42375-0723 | A-42375-0723 |
| 10 | 42375-0706 | A-42375-0706 | 28 | 42375-0724 | A-42375-0724 |
| 11 | 42375-0707 | A-42375-0707 | 29 | 42375-0725 | A-42375-0725 |
| 12 | 42375-0708 | A-42375-0708 | 30 | 42375-0726 | A-42375-0726 |
| 13 | 42375-0709 | A-42375-0709 | 31 | 42375-0727 | A-42375-0727 |
| 14 | 42375-0710 | A-42375-0710 | 32 | 42375-0728 | A-42375-0728 |
| 15 | 42375-0711 | A-42375-0711 | 33 | 42375-0729 | A-42375-0729 |
| 16 | 42375-0712 | A-42375-0712 | 34 | 42375-0730 | A-42375-0730 |
| 17 | 42375-0713 | A-42375-0713 | 35 | 42375-0731 | A-42375-0731 |
| 18 | 42375-0714 | A-42375-0714 | 36 | 42375-0732 | A-42375-0732 |
| 19 | 42375-0715 | A-42375-0715 | | | |

| | | | | | | |
|---------|---|--------|--------|---------------------------|--|--------|
| SYMBOLS | THIS DRAWING CONTAINS INFORMATION THAT IS PROPRIETARY TO MOLEX ELECTRONIC TECHNOLOGIES, LLC AND SHOULD NOT BE USED WITHOUT WRITTEN PERMISSION | | | | | |
| | DIMENSION UNITS | | SCALE | | CURRENT REV DESC: GOLD LENGTH SPEC CHANGED AS MIN 2.54- MAX 5.54 FOR A-42375-0037/0071 | |
| | MM/IN | | 1:1 | | | |
| | GENERAL TOLERANCES (UNLESS SPECIFIED) | | | | | |
| | | MM | INCH | EC NO: 689596 | | |
| ▽ = 0 | 4 PLACES | ± | ± | DRWN: SHRUTJ 2021/09/14 | | |
| ▽ = 0 | 3 PLACES | ± | ± 0.01 | CHK'D: SHRUTJ 2021/12/20 | | |
| ▽ = 0 | 2 PLACES | ± 0.25 | ± | APPR: ISHWARG 2021/12/20 | | |
| ▽ = 0 | 1 PLACE | ± 0.38 | ± | INITIAL REVISION: | | |
| ▽ = 0 | 0 PLACES | ± | ± | DRWN: SCHAFFER 2003/02/11 | | |
| □ = 0 | ANGULAR TOL ± 0.5° | | | APPR: MARGULIS 2004/02/27 | | |
| ■ = 0 | DRAFT WHERE APPLICABLE MUST REMAIN WITHIN DIMENSIONS | | | THIRD ANGLE PROJECTION | DRAWING | SERIES |
| ▽ = 0 | | | | ⊕ | B-SIZE | 42375 |

| | | |
|---|----------------|--------------|
| molex | | |
| KK 100 HEADER ASSY FLAT VERTICAL BREAKAWAY | | |
| PRODUCT CUSTOMER DRAWING | | |
| DOCUMENT NUMBER | DOC TYPE | DOC PART |
| SD-42375-001 | PSD | 001 |
| REVISION | | |
| V | | |
| MATERIAL NUMBER | CUSTOMER | SHEET NUMBER |
| SEE CHART | GENERAL MARKET | 11 OF 35 |

| ENG. NO: A-42375-0836/0870 | | | | | |
|----------------------------|-----------------|--------------------|------|-----------------|--------------|
| HEADER NUMBER: | | 42312-0036 | | | |
| PIN NUMBER: | | 42663-BSA154 | | | |
| PIN LENGTH: L | | .630 / 16.00 | | | |
| MATING LENGTH: M | | .405/10.29 | | | |
| GOLD POINT: G | | N/A | | | |
| PC TAIL LENGTH: P | | .135 / 3.43 | | | |
| TIN: T | | OVERALL | | | |
| CKTS: | | 2-36 | | | |
| KINKS: | | SMES-42003 | | | |
| VOIDED CKTS: | | NONE | | | |
| PACKAGING: | | BULK PK-40873-0041 | | | |
| CKTS | MATERIAL NUMBER | ENG NUMBER | CKTS | MATERIAL NUMBER | ENG NUMBER |
| 2 | | A-42375-0836 | 20 | 22-30-3203 | A-42375-0854 |
| 3 | 22-28-3033 | A-42375-0837 | 21 | 22-30-3213 | A-42375-0855 |
| 4 | 22-28-3043 | A-42375-0838 | 22 | 22-30-3223 | A-42375-0856 |
| 5 | 22-28-3053 | A-42375-0839 | 23 | 22-30-3233 | A-42375-0857 |
| 6 | 22-28-3063 | A-42375-0840 | 24 | 22-30-3243 | A-42375-0858 |
| 7 | 22-28-3073 | A-42375-0841 | 25 | 22-30-3253 | A-42375-0859 |
| 8 | 22-28-3083 | A-42375-0842 | 26 | 22-30-3263 | A-42375-0860 |
| 9 | 22-28-3093 | A-42375-0843 | 27 | 22-30-3273 | A-42375-0861 |
| 10 | 22-30-3103 | A-42375-0844 | 28 | 22-30-3283 | A-42375-0862 |
| 11 | 22-30-3113 | A-42375-0845 | 29 | 22-30-3293 | A-42375-0863 |
| 12 | 22-30-3123 | A-42375-0846 | 30 | 22-30-3303 | A-42375-0864 |
| 13 | 22-30-3133 | A-42375-0847 | 31 | 22-30-3313 | A-42375-0865 |
| 14 | 22-30-3143 | A-42375-0848 | 32 | 22-30-3323 | A-42375-0866 |
| 15 | 22-30-3153 | A-42375-0849 | 33 | 22-30-3333 | A-42375-0867 |
| 16 | 22-30-3163 | A-42375-0850 | 34 | 22-30-3343 | A-42375-0868 |
| 17 | 22-30-3173 | A-42375-0851 | 35 | 22-30-3353 | A-42375-0869 |
| 18 | 22-30-3183 | A-42375-0852 | 36 | 22-30-3363 | A-42375-0870 |
| 19 | 22-30-3193 | A-42375-0853 | | | |

| | | | | | |
|---------|---|------------------------|---|---------------|--|
| SYMBOLS | THIS DRAWING CONTAINS INFORMATION THAT IS PROPRIETARY TO MOLEX ELECTRONIC TECHNOLOGIES, LLC AND SHOULD NOT BE USED WITHOUT WRITTEN PERMISSION | | | | |
| | DIMENSION UNITS | SCALE | CURRENT REV DESC: GOLD LENGTH SPEC CHANGED AS MIN 2.54- MAX 5.54 FOR A-42375-0037/0071 | | |
| = 0 | MM/IN | 1:1 | KK 100 HEADER ASSY FLAT VERTICAL BREAKAWAY | | |
| = 0 | GENERAL TOLERANCES (UNLESS SPECIFIED) | | | | |
| = 0 | | | EC NO: 689596 DRWN: SHRUTJ 2021/09/14 CHK'D: SHRUTJ 2021/12/20 APPR: ISHWARG 2021/12/20 | | |
| = 0 | 4 PLACES ± | ± | PRODUCT CUSTOMER DRAWING DOCUMENT NUMBER: SD-42375-001 DOC TYPE: PSD DOC PART: 001 REVISION: V | | |
| = 0 | 3 PLACES ± | ± 0.01 | | | |
| = 0 | 2 PLACES ± | ± 0.25 | INITIAL REVISION: DRWN: SCHAFFER 2003/02/11 APPR: MARGULIS 2004/02/27 | | |
| = 0 | 1 PLACE ± | ± 0.38 | | | |
| = 0 | 0 PLACES ± | ± | MATERIAL NUMBER: SEE CHART CUSTOMER: GENERAL MARKET SHEET NUMBER: 12 OF 35 | | |
| = 0 | ANGULAR TOL ± | ± 0.5° | | | |
| = 0 | DRAFT WHERE APPLICABLE MUST REMAIN WITHIN DIMENSIONS | THIRD ANGLE PROJECTION | DRAWING: B-SIZE | SERIES: 42375 | |

| ENG. NO: A-42375-0871/0904 | | | | | |
|----------------------------|-----------------|--------------------|------|-----------------|--------------|
| HEADER NUMBER: | | 42312-0036 | | | |
| PIN NUMBER: | | 42663-ATA154 | | | |
| PIN LENGTH: L | | .530 / 13.46 | | | |
| MATING LENGTH: M | | .320 / 8.13 | | | |
| GOLD POINT: G | | N/A | | | |
| PC TAIL LENGTH: P | | .120 / 3.05 | | | |
| TIN: T | | OVERALL | | | |
| CKTS: | | 3-36 | | | |
| KINKS: | | NO | | | |
| VOIDED CKTS: | | 2 | | | |
| PACKAGING: | | BULK PK-40873-0041 | | | |
| CKTS | MATERIAL NUMBER | ENG NUMBER | CKTS | MATERIAL NUMBER | ENG NUMBER |
| 2 | | | 20 | 22-30-3204 | A-42375-0888 |
| 3 | 22-28-3034 | A-42375-0871 | 21 | 22-30-3214 | A-42375-0889 |
| 4 | 22-28-3044 | A-42375-0872 | 22 | 22-30-3224 | A-42375-0890 |
| 5 | 22-28-3054 | A-42375-0873 | 23 | 22-30-3234 | A-42375-0891 |
| 6 | 22-28-3064 | A-42375-08474 | 24 | 22-30-3244 | A-42375-0892 |
| 7 | 22-28-3074 | A-42375-0875 | 25 | 22-30-3254 | A-42375-0893 |
| 8 | 22-28-3084 | A-42375-0876 | 26 | 22-30-3264 | A-42375-0894 |
| 9 | 22-28-3094 | A-42375-0877 | 27 | 22-30-3274 | A-42375-0895 |
| 10 | 22-30-3104 | A-42375-0878 | 28 | 22-30-3284 | A-42375-0896 |
| 11 | 22-30-3114 | A-42375-0879 | 29 | 22-30-3294 | A-42375-0897 |
| 12 | 22-30-3124 | A-42375-0880 | 30 | 22-30-3304 | A-42375-0898 |
| 13 | 22-30-3134 | A-42375-0881 | 31 | 22-30-3314 | A-42375-0899 |
| 14 | 22-30-3144 | A-42375-0882 | 32 | 22-30-3324 | A-42375-0900 |
| 15 | 22-30-3154 | A-42375-0883 | 33 | 22-30-3334 | A-42375-0901 |
| 16 | 22-30-3164 | A-42375-0884 | 34 | 22-30-3344 | A-42375-0902 |
| 17 | 22-30-3174 | A-42375-0885 | 35 | 22-30-3354 | A-42375-0903 |
| 18 | 22-30-3184 | A-42375-0886 | 36 | 22-30-3364 | A-42375-0904 |
| 19 | 22-30-3194 | A-42375-0887 | | | |

| ENG. NO: A-42375-0973/1001 | | | | | |
|----------------------------|-----------------|--------------------|------|-----------------|--------------|
| HEADER NUMBER: | | 42312-0036 | | | |
| PIN NUMBER: | | 42663-ABA154 | | | |
| PIN LENGTH: L | | .455 / 11.56 | | | |
| MATING LENGTH: M | | .240 / 6.09 | | | |
| GOLD POINT: G | | N/A | | | |
| PC TAIL LENGTH: P | | .125 / 3.18 | | | |
| TIN: T | | OVERALL | | | |
| CKTS: | | 8-36 | | | |
| KINKS: | | NO | | | |
| VOIDED CKTS: | | 3,8 | | | |
| PACKAGING: | | BULK PK-40873-0041 | | | |
| CKTS | MATERIAL NUMBER | ENG NUMBER | CKTS | MATERIAL NUMBER | ENG NUMBER |
| 2 | | | 20 | 42375-0985 | A-42375-0985 |
| 3 | | | 21 | 42375-0986 | A-42375-0986 |
| 4 | | | 22 | 42375-0987 | A-42375-0987 |
| 5 | | | 23 | 42375-0988 | A-42375-0988 |
| 6 | | | 24 | 42375-0989 | A-42375-0989 |
| 7 | | | 25 | 42375-0990 | A-42375-0990 |
| 8 | 42375-0973 | A-42375-0973 | 26 | 42375-0991 | A-42375-0991 |
| 9 | 42375-0974 | A-42375-0974 | 27 | 42375-0992 | A-42375-0992 |
| 10 | 22-30-3107 | A-42375-0975 | 28 | 42375-0993 | A-42375-0993 |
| 11 | 42375-0976 | A-42375-0976 | 29 | 42375-0994 | A-42375-0994 |
| 12 | 42375-0977 | A-42375-0977 | 30 | 42375-0995 | A-42375-0995 |
| 13 | 42375-0978 | A-42375-0978 | 31 | 42375-0996 | A-42375-0996 |
| 14 | 42375-0979 | A-42375-0979 | 32 | 42375-0997 | A-42375-0997 |
| 15 | 42375-0980 | A-42375-0980 | 33 | 42375-0998 | A-42375-0998 |
| 16 | 42375-0981 | A-42375-0981 | 34 | 42375-0999 | A-42375-0999 |
| 17 | 42375-0982 | A-42375-0982 | 35 | 42375-1000 | A-42375-1000 |
| 18 | 42375-0983 | A-42375-0983 | 36 | 42375-1001 | A-42375-1001 |
| 19 | 42375-0984 | A-42375-0984 | | | |

DOCUMENT STATUS | P1 | RELEASE DATE | 2021/12/20 12:18:33

| | | | |
|---|---|--|---|
| SYMBOLS = 0 = 0 = 0 = 0 = 0 = 0 = 0 = 0 = 0 | THIS DRAWING CONTAINS INFORMATION THAT IS PROPRIETARY TO MOLEX ELECTRONIC TECHNOLOGIES, LLC AND SHOULD NOT BE USED WITHOUT WRITTEN PERMISSION DIMENSION UNITS: MM/IN SCALE: 1:1 | CURRENT REV DESC: GOLD LENGTH SPEC CHANGED AS MIN 2.54- MAX 5.54 FOR A-42375-0037/0071 | KK 100 HEADER ASSY FLAT VERTICAL BREAKAWAY PRODUCT CUSTOMER DRAWING |
| | GENERAL TOLERANCES (UNLESS SPECIFIED) | EC NO: 689596 DRWN: SHRUTJ 2021/09/14 CHK'D: SHRUTJ 2021/12/20 APPR: ISHWARG 2021/12/20 | |
| | 4 PLACES ± 3 PLACES ± 0.01 2 PLACES ± 0.25 1 PLACE ± 0.38 0 PLACES ± | INITIAL REVISION: DRWN: SCHAFFER 2003/02/11 APPR: MARGULIS 2004/02/27 | |
| | ANGULAR TOL ± 0.5° DRAFT WHERE APPLICABLE MUST REMAIN WITHIN DIMENSIONS | THIRD ANGLE PROJECTION DRAWING: B-SIZE SERIES: 42375 MATERIAL NUMBER: SEE CHART CUSTOMER: GENERAL MARKET SHEET NUMBER: 13 OF 35 | |

| ENG. NO: A-42375-1105/1139 | | | | | |
|----------------------------|-----------------|--------------------|------|-----------------|--------------|
| HEADER NUMBER: | | 42312-0036 | | | |
| PIN NUMBER: | | 42663-ABB208 | | | |
| PIN LENGTH: L | | .455 / 11.56 | | | |
| MATING LENGTH: M | | .240 / 6.09 | | | |
| GOLD POINT: G | | .100 / 2.54 | | | |
| PC TAIL LENGTH: P | | .125 / 3.18 | | | |
| TIN: T | | .100 / 2.54 | | | |
| CKTS: | | 2-36 | | | |
| KINKS: | | NO | | | |
| VOIDED CKTS: | | 4 | | | |
| PACKAGING: | | BULK PK-40873-0041 | | | |
| CKTS | MATERIAL NUMBER | ENG NUMBER | CKTS | MATERIAL NUMBER | ENG NUMBER |
| 2 | 42375-1105 | A-42375-1105 | 20 | 42375-1123 | A-42375-1123 |
| 3 | 42375-1106 | A-42375-1106 | 21 | 42375-1124 | A-42375-1124 |
| 4 | 42375-1107 | A-42375-1107 | 22 | 42375-1125 | A-42375-1125 |
| 5 | 42375-1108 | A-42375-1108 | 23 | 42375-1126 | A-42375-1126 |
| 6 | 42375-1109 | A-42375-1109 | 24 | 42375-1127 | A-42375-1127 |
| 7 | 42375-1110 | A-42375-1110 | 25 | 42375-1128 | A-42375-1128 |
| 8 | 42375-1111 | A-42375-1111 | 26 | 42375-1129 | A-42375-1129 |
| 9 | 42375-1112 | A-42375-1112 | 27 | 42375-1130 | A-42375-1130 |
| 10 | 42375-1113 | A-42375-1113 | 28 | 42375-1131 | A-42375-1131 |
| 11 | 42375-1114 | A-42375-1114 | 29 | 42375-1132 | A-42375-1132 |
| 12 | 42375-1115 | A-42375-1115 | 30 | 42375-1133 | A-42375-1133 |
| 13 | 42375-1116 | A-42375-1116 | 31 | 42375-1134 | A-42375-1134 |
| 14 | 42375-1117 | A-42375-1117 | 32 | 42375-1135 | A-42375-1135 |
| 15 | 42375-1118 | A-42375-1118 | 33 | 42375-1136 | A-42375-1136 |
| 16 | 42375-1119 | A-42375-1119 | 34 | 42375-1137 | A-42375-1137 |
| 17 | 42375-1120 | A-42375-1120 | 35 | 42375-1138 | A-42375-1138 |
| 18 | 42375-1121 | A-42375-1121 | 36 | 42375-1139 | A-42375-1139 |
| 19 | 42375-1122 | A-42375-1122 | | | |

| ENG. NO: 42375-1244/1278 | | | |
|--------------------------|-------------|--------------------|-----------------|
| HEADER NUMBER: | | 42312-0036 | |
| PIN NUMBER: | | 42663-ABA154 | |
| PIN LENGTH: L | | .455 / 11.56 | |
| MATING LENGTH: M | | .240 / 6.09 | |
| GOLD POINT: G | | N/A | |
| PC TAIL LENGTH: P | | .125 / 3.18 | |
| TIN: T | | OVERALL | |
| CKTS: | | 2-36 | |
| KINKS: | | NO | |
| VOIDED CKTS: | | 2 | |
| PACKAGING: | | BULK PK-40873-0041 | |
| CKTS | ITEM NUMBER | CKTS | MATERIAL NUMBER |
| 2 | 42375-1244 | 20 | 42375-1262 |
| 3 | 42375-1245 | 21 | 42375-1263 |
| 4 | 42375-1246 | 22 | 42375-1264 |
| 5 | 42375-1247 | 23 | 42375-1265 |
| 6 | 42375-1248 | 24 | 42375-1266 |
| 7 | 42375-1249 | 25 | 42375-1267 |
| 8 | 42375-1250 | 26 | 42375-1268 |
| 9 | 42375-1251 | 27 | 42375-1269 |
| 10 | 42375-1252 | 28 | 42375-1270 |
| 11 | 42375-1253 | 29 | 42375-1271 |
| 12 | 42375-1254 | 30 | 42375-1272 |
| 13 | 42375-1255 | 31 | 42375-1273 |
| 14 | 42375-1256 | 32 | 42375-1274 |
| 15 | 42375-1257 | 33 | 42375-1275 |
| 16 | 42375-1258 | 34 | 42375-1276 |
| 17 | 42375-1259 | 35 | 42375-1277 |
| 18 | 42375-1260 | 36 | 42375-1278 |
| 19 | 42375-1261 | | |

| | | | | |
|--|--|---|--|--|
| SYMBOLS  = 0  = 0  = 0  = 0  = 0  = 0  = 0  = 0 | DIMENSION UNITS MM/IN | SCALE 1:1 | CURRENT REV DESC: GOLD LENGTH SPEC CHANGED AS MIN 2.54- MAX 5.54 FOR A-42375-0037/0071 |  KK 100 HEADER ASSY FLAT VERTICAL BREAKAWAY PRODUCT CUSTOMER DRAWING |
| | GENERAL TOLERANCES (UNLESS SPECIFIED) | | EC NO: 689596 DRWN: SHRUTJ 2021/09/14 CHK'D: SHRUTJ 2021/12/20 APPR: ISHWARG 2021/12/20 | |
| | 4 PLACES ± 3 PLACES ± 2 PLACES ± 0.25 ± 1 PLACE ± 0.38 ± 0 PLACES ± | MM INCH | INITIAL REVISION: DRWN: SCHAFFER 2003/02/11 APPR: MARGULIS 2004/02/27 | |
| | ANGULAR TOL ± 0.5° DRAFT WHERE APPLICABLE MUST REMAIN WITHIN DIMENSIONS | THIRD ANGLE PROJECTION  | DRAWING SERIES B-SIZE 42375 | |
| DOCUMENT STATUS P1 RELEASE DATE 2021/12/20 12:18:33 | DOCUMENT NUMBER SD-42375-001 | DOC TYPE DOC PART REVISION PSD 001 V | MATERIAL NUMBER CUSTOMER SHEET NUMBER SEE CHART GENERAL MARKET 14 OF 35 | |

| ENG. NO: 42375-1349/1382 | | | |
|--------------------------|-------------|--------------------|-------------|
| HEADER NUMBER: | | 42312-0036 | |
| PIN NUMBER: | | 42663-ABA154 | |
| PIN LENGTH: L | | .455 / 11.56 | |
| MATING LENGTH: M | | .230 / 5.84 | |
| GOLD POINT: G | | N/A | |
| PC TAIL LENGTH: P | | .135 / 3.43 | |
| TIN: T | | OVERALL | |
| CKTS: | | 3-36 | |
| KINKS: | | SMES-42003 | |
| VOIDED CKTS: | | 2 | |
| PACKAGING: | | BULK PK-40873-0041 | |
| CKTS | ITEM NUMBER | CKTS | ITEM NUMBER |
| 2 | | 20 | 42375-1366 |
| 3 | 42375-1349 | 21 | 42375-1367 |
| 4 | 42375-1350 | 22 | 42375-1368 |
| 5 | 42375-1351 | 23 | 42375-1369 |
| 6 | 42375-1352 | 24 | 42375-1370 |
| 7 | 42375-1353 | 25 | 42375-1371 |
| 8 | 42375-1354 | 26 | 42375-1372 |
| 9 | 42375-1355 | 27 | 42375-1373 |
| 10 | 42375-1356 | 28 | 42375-1374 |
| 11 | 42375-1357 | 29 | 42375-1375 |
| 12 | 42375-1358 | 30 | 42375-1376 |
| 13 | 42375-1359 | 31 | 42375-1377 |
| 14 | 42375-1360 | 32 | 42375-1378 |
| 15 | 42375-1361 | 33 | 42375-1379 |
| 16 | 42375-1362 | 34 | 42375-1380 |
| 17 | 42375-1363 | 35 | 42375-1381 |
| 18 | 42375-1364 | 36 | 42375-1382 |
| 19 | 42375-1365 | | |

| ENG. NO: 42375-1515/1548 | | | |
|--------------------------|-------------|--------------------|-------------|
| HEADER NUMBER: | | 42312-0036 | |
| PIN NUMBER: | | 42663-ABB208 | |
| PIN LENGTH: L | | .455 / 11.56 | |
| MATING LENGTH: M | | .230 / 5.84 | |
| GOLD POINT: G | | .140 / 3.56 | |
| PC TAIL LENGTH: P | | .135 / 3.43 | |
| TIN: T | | .100 / 2.54 | |
| CKTS: | | 3-36 | |
| KINKS: | | SMES-42003 | |
| VOIDED CKTS: | | 2 | |
| PACKAGING: | | BULK PK-40873-0041 | |
| CKTS | ITEM NUMBER | CKTS | ITEM NUMBER |
| 2 | | 20 | 42375-1532 |
| 3 | 42375-1515 | 21 | 42375-1533 |
| 4 | 42375-1516 | 22 | 42375-1534 |
| 5 | 42375-1517 | 23 | 42375-1535 |
| 6 | 42375-1518 | 24 | 42375-1536 |
| 7 | 42375-1519 | 25 | 42375-1537 |
| 8 | 42375-1520 | 26 | 42375-1538 |
| 9 | 42375-1521 | 27 | 42375-1539 |
| 10 | 42375-1522 | 28 | 42375-1540 |
| 11 | 42375-1523 | 29 | 42375-1541 |
| 12 | 42375-1524 | 30 | 42375-1542 |
| 13 | 42375-1525 | 31 | 42375-1543 |
| 14 | 42375-1526 | 32 | 42375-1544 |
| 15 | 42375-1527 | 33 | 42375-1545 |
| 16 | 42375-1528 | 34 | 42375-1546 |
| 17 | 42375-1529 | 35 | 42375-1547 |
| 18 | 42375-1530 | 36 | 42375-1548 |
| 19 | 42375-1531 | | |

| | | | |
|---------|---|---------|--|
| SYMBOLS | THIS DRAWING CONTAINS INFORMATION THAT IS PROPRIETARY TO MOLEX ELECTRONIC TECHNOLOGIES, LLC AND SHOULD NOT BE USED WITHOUT WRITTEN PERMISSION | | |
| | DIMENSION UNITS | SCALE | CURRENT REV DESC: GOLD LENGTH SPEC CHANGED AS MIN 2.54- MAX 5.54 FOR A-42375-0037/0071 |
| ▽ = 0 | MM/IN | 1:1 |  KK 100 HEADER ASSY FLAT VERTICAL BREAKAWAY |
| ▽ = 0 | GENERAL TOLERANCES (UNLESS SPECIFIED) | | |
| ▽ = 0 | | | EC NO: 689596 DRWN: SHRUTJ 2021/09/14 CHK'D: SHRUTJ 2021/12/20 APPR: ISHWARG 2021/12/20 |
| ▽ = 0 | 4 PLACES ± | ± | |
| ▽ = 0 | 3 PLACES ± | ± 0.01 | PRODUCT CUSTOMER DRAWING DOCUMENT NUMBER: SD-42375-001 DOC TYPE: PSD DOC PART: 001 REVISION: V |
| ▽ = 0 | 2 PLACES ± | ± 0.25 | |
| ▽ = 0 | 1 PLACE ± | ± 0.38 | INITIAL REVISION: DRWN: SCHAFFER 2003/02/11 APPR: MARGULIS 2004/02/27 |
| ▽ = 0 | 0 PLACES ± | ± | |
| ▽ = 0 | ANGULAR TOL ± 0.5° | | MATERIAL NUMBER: SEE CHART CUSTOMER: GENERAL MARKET SHEET NUMBER: 15 OF 35 |
| ▽ = 0 | DRAFT WHERE APPLICABLE MUST REMAIN WITHIN DIMENSIONS | | |
| ▽ = 0 | THIRD ANGLE PROJECTION | DRAWING | SERIES |
| ▽ = 0 |  | B-SIZE | 42375 |

| | | | | |
|-----------------|----|--------------|------------|----------|
| DOCUMENT STATUS | P1 | RELEASE DATE | 2021/12/20 | 12:18:33 |
|-----------------|----|--------------|------------|----------|

E

E

| ENG. NO: 42375-1922/1956 | | | |
|--------------------------|-------------|--------------------|-------------|
| HEADER NUMBER: | | 42312-0036 | |
| PIN NUMBER: | | 42663-AEA154 | |
| PIN LENGTH: L | | .700 / 17.78 | |
| MATING LENGTH: M | | .190 / 4.83 | |
| GOLD POINT: G | | N/A | |
| PC TAIL LENGTH: P | | .190 / 4.83 | |
| TIN: T | | .200 / 5.08 | |
| CKTS: | | 2-36 | |
| KINKS: | | NO | |
| VOIDED CKTS: | | NONE | |
| PACKAGING: | | BULK PK-40873-0041 | |
| CKTS | ITEM NUMBER | CKTS | ITEM NUMBER |
| 2 | 42375-1922 | 20 | 42375-1873 |
| 3 | 42375-1923 | 21 | 42375-1874 |
| 4 | 42375-1924 | 22 | 42375-1875 |
| 5 | 42375-1925 | 23 | 42375-1876 |
| 6 | 42375-1926 | 24 | 42375-1877 |
| 7 | 42375-1927 | 25 | 42375-1878 |
| 8 | 42375-1928 | 26 | 42375-1879 |
| 9 | 42375-1929 | 27 | 42375-1880 |
| 10 | 42375-1930 | 28 | 42375-1881 |
| 11 | 42375-1931 | 29 | 42375-1882 |
| 12 | 42375-1932 | 30 | 42375-1883 |
| 13 | 42375-1933 | 31 | 42375-1884 |
| 14 | 42375-1934 | 32 | 42375-1885 |
| 15 | 42375-1935 | 33 | 42375-1886 |
| 16 | 42375-1936 | 34 | 42375-1887 |
| 17 | 42375-1937 | 35 | 42375-1888 |
| 18 | 42375-1938 | 36 | 42375-1889 |
| 19 | 42375-1939 | | |

| ENG. NO: 42375-2246/2275 | | | |
|--------------------------|-------------|--------------------|-------------|
| HEADER NUMBER: | | 42312-0036 | |
| PIN NUMBER: | | 42663-ABA154 | |
| PIN LENGTH: L | | .455 / 11.56 | |
| MATING LENGTH: M | | .240 / 6.09 | |
| GOLD POINT: G | | N/A | |
| PC TAIL LENGTH: P | | .125 / 3.18 | |
| TIN: T | | OVERALL | |
| CKTS: | | 7-36 | |
| KINKS: | | NO | |
| VOIDED CKTS: | | 2,7 | |
| PACKAGING: | | BULK PK-40873-0041 | |
| CKTS | ITEM NUMBER | CKTS | ITEM NUMBER |
| 2 | | 20 | 42375-2259 |
| 3 | | 21 | 42375-2260 |
| 4 | | 22 | 42375-2261 |
| 5 | | 23 | 42375-2262 |
| 6 | | 24 | 42375-2263 |
| 7 | 42375-2246 | 25 | 42375-2264 |
| 8 | 42375-2247 | 26 | 42375-2265 |
| 9 | 42375-2248 | 27 | 42375-2266 |
| 10 | 42375-2249 | 28 | 42375-2267 |
| 11 | 42375-2250 | 29 | 42375-2268 |
| 12 | 42375-2251 | 30 | 42375-2269 |
| 13 | 42375-2252 | 31 | 42375-2270 |
| 14 | 42375-2253 | 32 | 42375-2271 |
| 15 | 42375-2254 | 33 | 42375-2272 |
| 16 | 42375-2255 | 34 | 42375-2273 |
| 17 | 42375-2256 | 35 | 42375-2274 |
| 18 | 42375-2257 | 36 | 42375-2275 |
| 19 | 42375-2258 | | |

D

D

C

C

B

B

A

A

| | | | |
|--|--|--|--|
| SYMBOLS DIMENSION UNITS: MM/IN SCALE: 1:1 GENERAL TOLERANCES (UNLESS SPECIFIED) 4 PLACES ± 0.01 3 PLACES ± 0.02 2 PLACES ± 0.25 1 PLACE ± 0.38 0 PLACES ± 0.50 ANGULAR TOL ± 0.5° DRAFT WHERE APPLICABLE MUST REMAIN WITHIN DIMENSIONS THIRD ANGLE PROJECTION DRAWING SERIES: B-SIZE 42375 | THIS DRAWING CONTAINS INFORMATION THAT IS PROPRIETARY TO MOLEX ELECTRONIC TECHNOLOGIES, LLC AND SHOULD NOT BE USED WITHOUT WRITTEN PERMISSION CURRENT REV DESC: GOLD LENGTH SPEC CHANGED AS MIN 2.54- MAX 5.54 FOR A-42375-0037/0071 EC NO: 689596 DRWN: SHRUTJ 2021/09/14 CHK'D: SHRUTJ 2021/12/20 APPR: ISHWARG 2021/12/20 INITIAL REVISION: DRWN: SCHAFFER 2003/02/11 APPR: MARGULIS 2004/02/27 | |  KK 100 HEADER ASSY FLAT VERTICAL BREAKAWAY |
| | PRODUCT CUSTOMER DRAWING DOCUMENT NUMBER: SD-42375-001 DOC TYPE: PSD DOC PART: 001 REVISION: V | | |
| | MATERIAL NUMBER: SEE CHART CUSTOMER: GENERAL MARKET SHEET NUMBER: 17 OF 35 | | |

E

E

| ENG. NO: 42375-2486/2520 | | | |
|--------------------------|-------------|--------------------|-------------|
| HEADER NUMBER: | | 42312-0036 | |
| PIN NUMBER: | | 42663-AFB208 | |
| PIN LENGTH: L | | .475 / 12.07 | |
| MATING LENGTH: M | | .232 / 5.89 | |
| GOLD POINT: G | | .150 / 3.81 | |
| PC TAIL LENGTH: P | | .153 / 3.89 | |
| TIN: T | | .100 / 2.54 | |
| CKTS: | | 2-36 | |
| KINKS: | | NO | |
| VOIDED CKTS: | | NONE | |
| PACKAGING: | | BULK PK-40873-0041 | |
| CKTS | ITEM NUMBER | CKTS | ITEM NUMBER |
| 2 | 42375-2486 | 19 | 42375-2503 |
| 3 | 42375-2487 | 20 | 42375-2504 |
| | 68300-2008 | 21 | 42375-2505 |
| 4 | 42375-2488 | 22 | 42375-2506 |
| 5 | 42375-2489 | 23 | 42375-2507 |
| 6 | 42375-2490 | 24 | 42375-2508 |
| 7 | 42375-2491 | 25 | 42375-2509 |
| 8 | 42375-2492 | 26 | 42375-2510 |
| 9 | 42375-2493 | 27 | 42375-2511 |
| 10 | 42375-2494 | 28 | 42375-2512 |
| 11 | 42375-2495 | 29 | 42375-2513 |
| 12 | 42375-2496 | 30 | 42375-2514 |
| 13 | 42375-2497 | 31 | 42375-2515 |
| 14 | 42375-2498 | 32 | 42375-2516 |
| 15 | 42375-2499 | 33 | 42375-2517 |
| 16 | 42375-2500 | 34 | 42375-2518 |
| 17 | 42375-2501 | 35 | 42375-2519 |
| 18 | 42375-2502 | 36 | 42375-2520 |

| ENG. NO: 42375-2521/2555 | | | |
|--------------------------|-------------|--------------------|-------------|
| HEADER NUMBER: | | 42312-0036 | |
| PIN NUMBER: | | 42663-AFB228 | |
| PIN LENGTH: L | | .475 / 12.07 | |
| MATING LENGTH: M | | .232 / 5.89 | |
| GOLD POINT: G | | .150 / 3.81 | |
| PC TAIL LENGTH: P | | .153 / 3.89 | |
| TIN: T | | .100 / 2.54 | |
| CKTS: | | 2-36 | |
| KINKS: | | NO | |
| VOIDED CKTS: | | NONE | |
| PACKAGING: | | BULK PK-40873-0041 | |
| CKTS | ITEM NUMBER | CKTS | ITEM NUMBER |
| 2 | 42375-2521 | 20 | 42375-2539 |
| 3 | 42375-2522 | 21 | 42375-2540 |
| 4 | 42375-2523 | 22 | 42375-2541 |
| 5 | 42375-2524 | 23 | 42375-2542 |
| 6 | 42375-2525 | 24 | 42375-2543 |
| 7 | 42375-2526 | 25 | 42375-2544 |
| 8 | 42375-2527 | 26 | 42375-2545 |
| 9 | 42375-2528 | 27 | 42375-2546 |
| 10 | 42375-2529 | 28 | 42375-2547 |
| 11 | 42375-2530 | 29 | 42375-2548 |
| 12 | 42375-2531 | 30 | 42375-2549 |
| 13 | 42375-2532 | 31 | 42375-2550 |
| 14 | 42375-2533 | 32 | 42375-2551 |
| 15 | 42375-2534 | 33 | 42375-2552 |
| 16 | 42375-2535 | 34 | 42375-2553 |
| 17 | 42375-2536 | 35 | 42375-2554 |
| 18 | 42375-2537 | 36 | 42375-2555 |
| 19 | 42375-2539 | | |

D

D

C

C

B

B

A

A

| | | | |
|---------|---|---------|--|
| SYMBOLS | THIS DRAWING CONTAINS INFORMATION THAT IS PROPRIETARY TO MOLEX ELECTRONIC TECHNOLOGIES, LLC AND SHOULD NOT BE USED WITHOUT WRITTEN PERMISSION | | |
| | DIMENSION UNITS | SCALE | CURRENT REV DESC: GOLD LENGTH SPEC CHANGED AS MIN 2.54- MAX 5.54 FOR A-42375-0037/0071 |
| ▽ = 0 | MM/IN | 1:1 |  KK 100 HEADER ASSY FLAT VERTICAL BREAKAWAY |
| ▽ = 0 | GENERAL TOLERANCES (UNLESS SPECIFIED) | | |
| ▽ = 0 | | | EC NO: 689596 DRWN: SHRUTJ 2021/09/14 CHK'D: SHRUTJ 2021/12/20 APPR: ISHWARG 2021/12/20 |
| ▽ = 0 | 4 PLACES ± | ± | |
| ▽ = 0 | 3 PLACES ± | ± 0.01 | PRODUCT CUSTOMER DRAWING DOCUMENT NUMBER: SD-42375-001 DOC TYPE: PSD DOC PART: 001 REVISION: V |
| ▽ = 0 | 2 PLACES ± | ± 0.25 | |
| ▽ = 0 | 1 PLACE ± | ± 0.38 | INITIAL REVISION: DRWN: SCHAFFER 2003/02/11 APPR: MARGULIS 2004/02/27 |
| ▽ = 0 | 0 PLACES ± | ± | |
| ▽ = 0 | ANGULAR TOL ± 0.5° | | MATERIAL NUMBER: SEE CHART CUSTOMER: GENERAL MARKET SHEET NUMBER: 18 OF 35 |
| ▽ = 0 | DRAFT WHERE APPLICABLE MUST REMAIN WITHIN DIMENSIONS | | |
| ▽ = 0 | THIRD ANGLE PROJECTION | DRAWING | SERIES |
| |  | B-SIZE | 42375 |

| | | | | |
|-----------------|----|--------------|------------|----------|
| DOCUMENT STATUS | P1 | RELEASE DATE | 2021/12/20 | 12:18:33 |
|-----------------|----|--------------|------------|----------|

E

E

| ENG. NO: 42375-2801/2835 | | | |
|--------------------------|-------------|--------------------|-------------|
| HEADER NUMBER: | | 42312-0036 | |
| PIN NUMBER: | | 42663-HDB228 | |
| PIN LENGTH: L | | 1.200 / 30.48 | |
| MATING LENGTH: M | | 1.000 / 25.40 | |
| GOLD POINT: G | | .200 / 5.08 | |
| PC TAIL LENGTH: P | | .110 / 2.79 | |
| TIN: T | | .200 / 5.08 | |
| CKTS: | | 2-36 | |
| KINKS: | | NO | |
| VOIDED CKTS: | | NONE | |
| PACKAGING: | | BULK PK-40873-0043 | |
| CKTS | ITEM NUMBER | CKTS | ITEM NUMBER |
| 2 | 42375-2801 | 20 | 42375-2819 |
| 3 | 42375-2802 | 21 | 42375-2820 |
| 4 | 42375-2803 | 22 | 42375-2821 |
| 5 | 42375-2804 | 23 | 42375-2822 |
| 6 | 42375-2805 | 24 | 42375-2823 |
| 7 | 42375-2806 | 25 | 42375-2824 |
| 8 | 42375-2807 | 26 | 42375-2825 |
| 9 | 42375-2808 | 27 | 42375-2826 |
| 10 | 42375-2809 | 28 | 42375-2827 |
| 11 | 42375-2810 | 29 | 42375-2828 |
| 12 | 42375-2811 | 30 | 42375-2829 |
| 13 | 42375-2812 | 31 | 42375-2830 |
| 14 | 42375-2813 | 32 | 42375-2831 |
| 15 | 42375-2814 | 33 | 42375-2832 |
| 16 | 42375-2815 | 34 | 42375-2833 |
| 17 | 42375-2816 | 35 | 42375-2834 |
| 18 | 42375-2817 | 36 | 42375-2835 |
| 19 | 42375-2818 | | |

| ENG. NO: 42375-2836/2870 | | | |
|--------------------------|-------------|--------------------|-------------|
| HEADER NUMBER: | | 42312-0036 | |
| PIN NUMBER: | | 42663-EMA154 | |
| PIN LENGTH: L | | .925 / 23.50 | |
| MATING LENGTH: M | | .625 / 15.88 | |
| GOLD POINT: G | | N/A | |
| PC TAIL LENGTH: P | | .210 / 5.33 | |
| TIN: T | | OVERALL | |
| CKTS: | | 2-36 | |
| KINKS: | | NO | |
| VOIDED CKTS: | | NONE | |
| PACKAGING: | | BULK PK-40873-0041 | |
| CKTS | ITEM NUMBER | CKTS | ITEM NUMBER |
| 2 | 42375-2836 | 20 | 42375-2854 |
| 3 | 42375-2837 | 21 | 42375-2855 |
| 4 | 42375-2838 | 22 | 42375-2856 |
| 5 | 42375-2839 | 23 | 42375-2857 |
| 6 | 42375-2840 | 24 | 42375-2858 |
| 7 | 42375-2841 | 25 | 42375-2859 |
| 8 | 42375-2842 | 26 | 42375-2860 |
| 9 | 42375-2843 | 27 | 42375-2861 |
| 10 | 42375-2844 | 28 | 42375-2862 |
| 11 | 42375-2845 | 29 | 42375-2863 |
| 12 | 42375-2846 | 30 | 42375-2864 |
| 13 | 42375-2847 | 31 | 42375-2865 |
| 14 | 42375-2848 | 32 | 42375-2866 |
| 15 | 42375-2849 | 33 | 42375-2867 |
| 16 | 42375-2850 | 34 | 42375-2868 |
| 17 | 42375-2851 | 35 | 42375-2869 |
| 18 | 42375-2852 | 36 | 42375-2870 |
| 19 | 42375-2853 | | |

D

D

C

C

B

B

A



A

| | | | | | | |
|---|---|--|--|--|--|---|
| SYMBOLS ▽ = 0 ▽ = 0 ▽ = 0 ▽ = 0 ▽ = 0 ▽ = 0 ▽ = 0 ▽ = 0 ▽ = 0 ▽ = 0 ▽ = 0 | THIS DRAWING CONTAINS INFORMATION THAT IS PROPRIETARY TO MOLEX ELECTRONIC TECHNOLOGIES, LLC AND SHOULD NOT BE USED WITHOUT WRITTEN PERMISSION | | CURRENT REV DESC: GOLD LENGTH SPEC CHANGED AS MIN 2.54- MAX 5.54 FOR A-42375-0037/0071 | |  KK 100 HEADER ASSY FLAT VERTICAL BREAKAWAY PRODUCT CUSTOMER DRAWING | |
| | DIMENSION UNITS: MM/IN SCALE: 1:1 | | GENERAL TOLERANCES (UNLESS SPECIFIED) | | | EC NO: 689596 DRWN: SHRUTJ 2021/09/14 CHK'D: SHRUTJ 2021/12/20 APPR: ISHWARG 2021/12/20 |
| | 4 PLACES ± ± 3 PLACES ± ± 0.01 2 PLACES ± 0.25 ± 1 PLACE ± 0.38 ± 0 PLACES ± ± | | INITIAL REVISION: DRWN: SCHAFFER 2003/02/11 APPR: MARGULIS 2004/02/27 | | | |
| | ANGULAR TOL ± 0.5° | | DRAFT WHERE APPLICABLE MUST REMAIN WITHIN DIMENSIONS | | | DOCUMENT NUMBER: SD-42375-001 DOC TYPE: PSD DOC PART: 001 REVISION: V |
| | THIRD ANGLE PROJECTION | | DRAWING: B-SIZE SERIES: 42375 | | | MATERIAL NUMBER: SEE CHART CUSTOMER: GENERAL MARKET SHEET NUMBER: 19 OF 35 |

| | | | | |
|-----------------|----|--------------|------------|----------|
| DOCUMENT STATUS | P1 | RELEASE DATE | 2021/12/20 | 12:18:33 |
|-----------------|----|--------------|------------|----------|

| ENG. NO: 42375-3044/3078 | | | |
|--------------------------|-------------|--------------------|-------------|
| HEADER NUMBER: | | 42312-0036 | |
| PIN NUMBER: | | 42663-KHB208 | |
| PIN LENGTH: L | | 1.430 / 36.32 | |
| MATING LENGTH: M | | .867 / 22.02 | |
| GOLD POINT: G | | .200 / 5.08 | |
| PC TAIL LENGTH: P | | .473 / 12.01 | |
| TIN: T | | .200 / 5.08 | |
| CKTS: | | 2-36 | |
| KINKS: | | NO | |
| VOIDED CKTS: | | NONE | |
| PACKAGING: | | BULK PK-40873-0043 | |
| CKTS | ITEM NUMBER | CKTS | ITEM NUMBER |
| 2 | 42375-3044 | 20 | 42375-3062 |
| 3 | 42375-3045 | 21 | 42375-3063 |
| 4 | 42375-3046 | 22 | 42375-3064 |
| 5 | 42375-3047 | 23 | 42375-3065 |
| 6 | 42375-3048 | 24 | 42375-3066 |
| 7 | 42375-3049 | 25 | 42375-3067 |
| 8 | 42375-3050 | 26 | 42375-3068 |
| 9 | 42375-3051 | 27 | 42375-3069 |
| 10 | 42375-3052 | 28 | 42375-3070 |
| 11 | 42375-3053 | 29 | 42375-3071 |
| 12 | 42375-3054 | 30 | 42375-3072 |
| 13 | 42375-3055 | 31 | 42375-3073 |
| 14 | 42375-3056 | 32 | 42375-3074 |
| 15 | 42375-3057 | 33 | 42375-3075 |
| 16 | 42375-3058 | 34 | 42375-3076 |
| 17 | 42375-3059 | 35 | 42375-3077 |
| 18 | 42375-3060 | 36 | 42375-3078 |
| 19 | 42375-3061 | | |

| ENG. NO: 42375-3114/3148 | | | |
|--------------------------|-------------|--------------------|-------------|
| HEADER NUMBER: | | 42312-0036 | |
| PIN NUMBER: | | 42663-BXA154 | |
| PIN LENGTH: L | | .645 / 16.38 | |
| MATING LENGTH: M | | .431 / 10.95 | |
| GOLD POINT: G | | N/A | |
| PC TAIL LENGTH: P | | .124 / 3.15 | |
| TIN: T | | OVERALL | |
| CKTS: | | 2-36 | |
| KINKS: | | NO | |
| VOIDED CKTS: | | NONE | |
| PACKAGING: | | BULK PK-40873-0041 | |
| CKTS | ITEM NUMBER | CKTS | ITEM NUMBER |
| 2 | 42375-3114 | 20 | 42375-3132 |
| 3 | 42375-3115 | 21 | 42375-3133 |
| 4 | 42375-3116 | 22 | 42375-3134 |
| 5 | 42375-3117 | 23 | 42375-3135 |
| 6 | 42375-3118 | 24 | 42375-3136 |
| 7 | 42375-3119 | 25 | 42375-3137 |
| 8 | 42375-3120 | 26 | 42375-3138 |
| 9 | 42375-3121 | 27 | 42375-3139 |
| 10 | 42375-3122 | 28 | 42375-3140 |
| 11 | 42375-3123 | 29 | 42375-3141 |
| 12 | 42375-3124 | 30 | 42375-3142 |
| 13 | 42375-3125 | 31 | 42375-3143 |
| 14 | 42375-3126 | 32 | 42375-3144 |
| 15 | 42375-3127 | 33 | 42375-3145 |
| 16 | 42375-3128 | 34 | 42375-3146 |
| 17 | 42375-3129 | 35 | 42375-3147 |
| 18 | 42375-3130 | 36 | 42375-3148 |
| 19 | 42375-3131 | | |

| | | | |
|---------|---|----------|--|
| SYMBOLS | THIS DRAWING CONTAINS INFORMATION THAT IS PROPRIETARY TO MOLEX ELECTRONIC TECHNOLOGIES, LLC AND SHOULD NOT BE USED WITHOUT WRITTEN PERMISSION | | |
| | DIMENSION UNITS | SCALE | CURRENT REV DESC: GOLD LENGTH SPEC CHANGED AS MIN 2.54- MAX 5.54 FOR A-42375-0037/0071 |
| ▽ = 0 | MM/IN | 1:1 |  KK 100 HEADER ASSY FLAT VERTICAL BREAKAWAY |
| ▽ = 0 | GENERAL TOLERANCES (UNLESS SPECIFIED) | | |
| ▽ = 0 | | | EC NO: 689596 DRWN: SHRUTJ 2021/09/14 CHK'D: SHRUTJ 2021/12/20 APPR: ISHWARG 2021/12/20 |
| ▽ = 0 | 4 PLACES ± | ± | |
| ▽ = 0 | 3 PLACES ± | ± 0.01 | PRODUCT CUSTOMER DRAWING DOCUMENT NUMBER: SD-42375-001 DOC TYPE: PSD DOC PART: 001 REVISION: V |
| ▽ = 0 | 2 PLACES ± | ± 0.25 ± | |
| ▽ = 0 | 1 PLACE ± | ± 0.38 ± | INITIAL REVISION: DRWN: SCHAFFER 2003/02/11 APPR: MARGULIS 2004/02/27 |
| ▽ = 0 | 0 PLACES ± | ± | |
| ▽ = 0 | ANGULAR TOL ± 0.5° | | MATERIAL NUMBER: SEE CHART CUSTOMER: GENERAL MARKET SHEET NUMBER: 20 OF 35 |
| ▽ = 0 | DRAFT WHERE APPLICABLE MUST REMAIN WITHIN DIMENSIONS | | |
| ▽ = 0 | THIRD ANGLE PROJECTION | DRAWING | SERIES |
| |  | B-SIZE | 42375 |

| ENG. NO: 42375-3149 / 3183 | | | |
|----------------------------|-------------|--------------------|-------------|
| HEADER NUMBER: | | 42312-0036 | |
| PIN NUMBER: | | 42663-BEB208 | |
| PIN LENGTH: L | | .575 / 14.61 | |
| MATING LENGTH: M | | .350 / 8.89 | |
| GOLD POINT: G | | .200 / 5.08 | |
| PC TAIL LENGTH: P | | .135 / 3.43 | |
| TIN: T | | .200 / 5.08 | |
| CKTS: | | 2-36 | |
| KINKS: | | NO | |
| VOIDED CKTS: | | NONE | |
| PACKAGING: | | BULK PK-40873-0041 | |
| CKTS | ITEM NUMBER | CKTS | ITEM NUMBER |
| 2 | 42375-3149 | 20 | 42375-3167 |
| 3 | 42375-3150 | 21 | 42375-3168 |
| 4 | 42375-3151 | 22 | 42375-3169 |
| 5 | 42375-3152 | 23 | 42375-3170 |
| 6 | 42375-3153 | 24 | 42375-3171 |
| 7 | 42375-3154 | 25 | 42375-3172 |
| 8 | 42375-3155 | 26 | 42375-3173 |
| 9 | 42375-3156 | 27 | 42375-3174 |
| 10 | 42375-3157 | 28 | 42375-3175 |
| 11 | 42375-3158 | 29 | 42375-3176 |
| 12 | 42375-3159 | 30 | 42375-3177 |
| 13 | 42375-3160 | 31 | 42375-3178 |
| 14 | 42375-3161 | 32 | 42375-3179 |
| 15 | 42375-3162 | 33 | 42375-3180 |
| 16 | 42375-3163 | 34 | 42375-3181 |
| 17 | 42375-3164 | 35 | 42375-3182 |
| 18 | 42375-3165 | 36 | 42375-3183 |
| 19 | 42375-3166 | | |

| ENG. NO: 42375-3184 / 3218 | | | |
|----------------------------|-------------|--------------------|-------------|
| HEADER NUMBER: | | 42312-0036 | |
| PIN NUMBER: | | 42663-GNB208 | |
| PIN LENGTH: L | | 1.140 / 28.96 | |
| MATING LENGTH: M | | .913 / 23.20 | |
| GOLD POINT: G | | .200 / 5.08 | |
| PC TAIL LENGTH: P | | .137 / 3.48 | |
| TIN: T | | .200 / 5.08 | |
| CKTS: | | 2-36 | |
| KINKS: | | NO | |
| VOIDED CKTS: | | NONE | |
| PACKAGING: | | BULK PK-40873-0043 | |
| CKTS | ITEM NUMBER | CKTS | ITEM NUMBER |
| 2 | 42375-3184 | 20 | 42375-3202 |
| 3 | 42375-3185 | 21 | 42375-3203 |
| 4 | 42375-3186 | 22 | 42375-3204 |
| 5 | 42375-3187 | 23 | 42375-3205 |
| 6 | 42375-3188 | 24 | 42375-3206 |
| 7 | 42375-3189 | 25 | 42375-3207 |
| 8 | 42375-3190 | 26 | 42375-3208 |
| 9 | 42375-3191 | 27 | 42375-3209 |
| 10 | 42375-3192 | 28 | 42375-3210 |
| 11 | 42375-3193 | 29 | 42375-3211 |
| 12 | 42375-3194 | 30 | 42375-3212 |
| 13 | 42375-3195 | 31 | 42375-3213 |
| 14 | 42375-3196 | 32 | 42375-3214 |
| 15 | 42375-3197 | 33 | 42375-3215 |
| 16 | 42375-3198 | 34 | 42375-3216 |
| 17 | 42375-3199 | 35 | 42375-3217 |
| 18 | 42375-3200 | 36 | 42375-3218 |
| 19 | 42375-3201 | | |

| ENG. NO: 42375-3219 / 3253 | | | |
|----------------------------|-------------|--------------------|-------------|
| HEADER NUMBER: | | 42312-0036 | |
| PIN NUMBER: | | 42663-BPA154 | |
| PIN LENGTH: L | | .620 / 15.75 | |
| MATING LENGTH: M | | .280 / 7.11 | |
| GOLD POINT: G | | NA | |
| PC TAIL LENGTH: P | | .250 / 6.35 | |
| TIN: T | | OVERALL | |
| CKTS: | | 2-36 | |
| KINKS: | | NO | |
| VOIDED CKTS: | | NONE | |
| PACKAGING: | | BULK PK-40873-0041 | |
| CKTS | ITEM NUMBER | CKTS | ITEM NUMBER |
| 2 | 42375-3219 | 20 | 42375-3237 |
| 3 | 42375-3220 | 21 | 42375-3238 |
| 4 | 42375-3221 | 22 | 42375-3239 |
| 5 | 42375-3222 | 23 | 42375-3240 |
| 6 | 42375-3223 | 24 | 42375-3241 |
| 7 | 42375-3224 | 25 | 42375-3242 |
| 8 | 42375-3225 | 26 | 42375-3243 |
| 9 | 42375-3226 | 27 | 42375-3244 |
| 10 | 42375-3227 | 28 | 42375-3245 |
| 11 | 42375-3228 | 29 | 42375-3246 |
| 12 | 42375-3229 | 30 | 42375-3247 |
| 13 | 42375-3230 | 31 | 42375-3248 |
| 14 | 42375-3231 | 32 | 42375-3249 |
| 15 | 42375-3232 | 33 | 42375-3250 |
| 16 | 42375-3233 | 34 | 42375-3251 |
| 17 | 42375-3234 | 35 | 42375-3252 |
| 18 | 42375-3235 | 36 | 42375-3253 |
| 19 | 42375-3236 | | |

| | | | | | | | | | | | | | | | | | | | | |
|---|---|--|---------------------------------|--|--|--|--|--|--------------------------|--|--------------------------|--|---|--|------------------------|--|------------------------|--|----------------------|--|
| SYMBOLS = 0 = 0 = 0 = 0 = 0 = 0 = 0 = 0 = 0 | THIS DRAWING CONTAINS INFORMATION THAT IS PROPRIETARY TO MOLEX ELECTRONIC TECHNOLOGIES, LLC AND SHOULD NOT BE USED WITHOUT WRITTEN PERMISSION | | DIMENSION UNITS MM/IN | | SCALE 1:1 | | CURRENT REV DESC: GOLD LENGTH SPEC CHANGED AS MIN 2.54- MAX 5.54 FOR A-42375-0037/0071 | | | | | | | | | | | | | |
| | GENERAL TOLERANCES (UNLESS SPECIFIED) | | EC NO: 689596 | | DRWN: SHRUTJ 2021/09/14 | | CHK'D: SHRUTJ 2021/12/20 | | | | | | KK 100 HEADER ASSY FLAT VERTICAL BREAKAWAY | | | | | | | |
| | 4 PLACES ± 0.25 ± | | 3 PLACES ± 0.25 ± | | 2 PLACES ± 0.25 ± | | 1 PLACE ± 0.38 ± | | APPR: ISHWARG 2021/12/20 | | PRODUCT CUSTOMER DRAWING | | | | | | | | | |
| | 0 PLACES ± 0.38 ± | | ANGULAR TOL ± 0.5° | | DRAFT WHERE APPLICABLE MUST REMAIN WITHIN DIMENSIONS | | THIRD ANGLE PROJECTION | | DRAWING B-SIZE | | SERIES 42375 | | DOCUMENT NUMBER SD-42375-001 | | DOC TYPE PSD | | DOC PART 001 | | REVISION V | |
| | MATERIAL NUMBER SEE CHART | | CUSTOMER GENERAL MARKET | | SHEET NUMBER 21 OF 35 | | | | | | | | | | | | | | | |

| ENG. NO: 42375-3254 / 3288 | | | |
|----------------------------|--------------------|------|-------------|
| HEADER NUMBER: | 42312-0036 | | |
| PIN NUMBER: | 42663-DMA154 | | |
| PIN LENGTH: L | .820 / 20.83 | | |
| MATING LENGTH: M | .590 / 14.99 | | |
| GOLD POINT: G | NA | | |
| PC TAIL LENGTH: P | .140 / 3.56 | | |
| TIN: T | OVERALL | | |
| CKTS: | 2-36 | | |
| KINKS: | NO | | |
| VOIDED CKTS: | NONE | | |
| PACKAGING: | BULK PK-40873-0041 | | |
| CKTS | ITEM NUMBER | CKTS | ITEM NUMBER |
| 2 | 42375-3254 | 20 | 42375-3272 |
| 3 | 42375-3255 | 21 | 42375-3273 |
| 4 | 42375-3256 | 22 | 42375-3274 |
| 5 | 42375-3257 | 23 | 42375-3275 |
| 6 | 42375-3258 | 24 | 42375-3276 |
| 7 | 42375-3259 | 25 | 42375-3277 |
| 8 | 42375-3260 | 26 | 42375-3278 |
| 9 | 42375-3261 | 27 | 42375-3279 |
| 10 | 42375-3262 | 28 | 42375-3280 |
| 11 | 42375-3263 | 29 | 42375-3281 |
| 12 | 42375-3264 | 30 | 42375-3282 |
| 13 | 42375-3265 | 31 | 42375-3283 |
| 14 | 42375-3266 | 32 | 42375-3284 |
| 15 | 42375-3267 | 33 | 42375-3285 |
| 16 | 42375-3268 | 34 | 42375-3286 |
| 17 | 42375-3269 | 35 | 42375-3287 |
| 18 | 42375-3270 | 36 | 42375-3288 |
| 19 | 42375-3271 | | |

| ENG. NO: 42375-3289 / 3323 | | | |
|----------------------------|--------------------|------|-------------|
| HEADER NUMBER: | 42312-0036 | | |
| PIN NUMBER: | 42663-FNA154 | | |
| PIN LENGTH: L | 1.035 / 26.29 | | |
| MATING LENGTH: M | .358 / 9.09 | | |
| GOLD POINT: G | NA | | |
| PC TAIL LENGTH: P | .587 / 14.91 | | |
| TIN: T | OVERALL | | |
| CKTS: | 2-36 | | |
| KINKS: | NO | | |
| VOIDED CKTS: | NONE | | |
| PACKAGING: | BULK PK-40873-0043 | | |
| CKTS | ITEM NUMBER | CKTS | ITEM NUMBER |
| 2 | 42375-3289 | 20 | 42375-3307 |
| 3 | 42375-3290 | 21 | 42375-3308 |
| 4 | 42375-3291 | 22 | 42375-3309 |
| 5 | 42375-3292 | 23 | 42375-3310 |
| 6 | 42375-3293 | 24 | 42375-3311 |
| 7 | 42375-3294 | 25 | 42375-3312 |
| 8 | 42375-3295 | 26 | 42375-3313 |
| 9 | 42375-3296 | 27 | 42375-3314 |
| 10 | 42375-3297 | 28 | 42375-3315 |
| 11 | 42375-3298 | 29 | 42375-3316 |
| 12 | 42375-3299 | 30 | 42375-3317 |
| 13 | 42375-3300 | 31 | 42375-3318 |
| 14 | 42375-3301 | 32 | 42375-3319 |
| 15 | 42375-3302 | 33 | 42375-3320 |
| 16 | 42375-3303 | 34 | 42375-3321 |
| 17 | 42375-3304 | 35 | 42375-3322 |
| 18 | 42375-3305 | 36 | 42375-3323 |
| 19 | 42375-3306 | | |

| ENG. NO: 42375-3324 / 3358 | | | |
|----------------------------|--------------------|------|-------------|
| HEADER NUMBER: | 42312-0036 | | |
| PIN NUMBER: | 42663-CCA154 | | |
| PIN LENGTH: L | .670 / 17.02 | | |
| MATING LENGTH: M | .440 / 11.18 | | |
| GOLD POINT: G | NA | | |
| PC TAIL LENGTH: P | .140 / 3.56 | | |
| TIN: T | OVERALL | | |
| CKTS: | 2-36 | | |
| KINKS: | SMES-42003 | | |
| VOIDED CKTS: | NONE | | |
| PACKAGING: | BULK PK-40873-0041 | | |
| CKTS | ITEM NUMBER | CKTS | ITEM NUMBER |
| 2 | 42375-3324 | 20 | 42375-3342 |
| 3 | 42375-3325 | 21 | 42375-3343 |
| 4 | 42375-3326 | 22 | 42375-3344 |
| 5 | 42375-3327 | 23 | 42375-3345 |
| 6 | 42375-3328 | 24 | 42375-3346 |
| 7 | 42375-3329 | 25 | 42375-3347 |
| 8 | 42375-3330 | 26 | 42375-3348 |
| 9 | 42375-3331 | 27 | 42375-3349 |
| 10 | 42375-3332 | 28 | 42375-3350 |
| 11 | 42375-3333 | 29 | 42375-3351 |
| 12 | 42375-3334 | 30 | 42375-3352 |
| 13 | 42375-3335 | 31 | 42375-3353 |
| 14 | 42375-3336 | 32 | 42375-3354 |
| 15 | 42375-3337 | 33 | 42375-3355 |
| 16 | 42375-3338 | 34 | 42375-3356 |
| 17 | 42375-3339 | 35 | 42375-3357 |
| 18 | 42375-3340 | 36 | 42375-3358 |
| 19 | 42375-3341 | | |

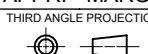
| | | | | | | | | | | |
|--|---|--|---|--|-------------------------|--|--|--|---|--|
| SYMBOLS ▽ = 0 ▽ = 0 ▽ = 0 ▽ = 0 ▽ = 0 ▽ = 0 ▽ = 0 ▽ = 0 ▽ = 0 ▽ = 0 | THIS DRAWING CONTAINS INFORMATION THAT IS PROPRIETARY TO MOLEX ELECTRONIC TECHNOLOGIES, LLC AND SHOULD NOT BE USED WITHOUT WRITTEN PERMISSION | | DIMENSION UNITS MM/IN | | SCALE 1:1 | | CURRENT REV DESC: GOLD LENGTH SPEC CHANGED AS MIN 2.54- MAX 5.54 FOR A-42375-0037/0071 | |  | |
| | GENERAL TOLERANCES (UNLESS SPECIFIED) | | EC NO: 689596 | | DRWN: SHRUTJ 2021/09/14 | | DRWN: SHRUTJ 2021/12/20 | | | |
| | 4 PLACES ± | | 3 PLACES ± | | 2 PLACES ± 0.25 ± | | 1 PLACE ± 0.38 ± | | APPR: ISHWARG 2021/12/20 | |
| | 0 PLACES ± | | ANGULAR TOL ± 0.5° | | INITIAL REVISION: | | DRWN: SCHAFFER 2003/02/11 | | APPR: MARGULIS 2004/02/27 | |
| | DRAFT WHERE APPLICABLE MUST REMAIN WITHIN DIMENSIONS | | THIRD ANGLE PROJECTION | | DRAWING | | SERIES | | DOCUMENT NUMBER | |
| | | |  | | B-SIZE | | 42375 | | DOC TYPE DOC PART REVISION | |
| | | | | | MATERIAL NUMBER | | CUSTOMER | | SHEET NUMBER | |
| | | | | | SEE CHART | | GENERAL MARKET | | SD-42375-001 PSD 001 V 22 OF 35 | |

| ENG. NO: 42375-3359 / 3393 | | | |
|----------------------------|-------------|--------------------|-------------|
| HEADER NUMBER: | | 42312-0036 | |
| PIN NUMBER: | | 42663-ABB228 | |
| PIN LENGTH: L | | .455 / 11.56 | |
| MATING LENGTH: M | | .170 / 4.32 | |
| GOLD POINT: G | | .100 / 2.54 | |
| PC TAIL LENGTH: P | | .195 / 4.95 | |
| TIN: T | | .100 / 2.54 | |
| CKTS: | | 2-36 | |
| KINKS: | | NO | |
| VOIDED CKTS: | | NONE | |
| PACKAGING: | | BULK PK-40873-0041 | |
| CKTS | ITEM NUMBER | CKTS | ITEM NUMBER |
| 2 | 42375-3359 | 20 | 42375-3377 |
| 3 | 42375-3360 | 21 | 42375-3378 |
| 4 | 42375-3361 | 22 | 42375-3379 |
| 5 | 42375-3362 | 23 | 42375-3380 |
| 6 | 42375-3363 | 24 | 42375-3381 |
| 7 | 42375-3364 | 25 | 42375-3382 |
| 8 | 42375-3365 | 26 | 42375-3383 |
| 9 | 42375-3366 | 27 | 42375-3384 |
| 10 | 42375-3367 | 28 | 42375-3385 |
| 11 | 42375-3368 | 29 | 42375-3386 |
| 12 | 42375-3369 | 30 | 42375-3387 |
| 13 | 42375-3370 | 31 | 42375-3388 |
| 14 | 42375-3371 | 32 | 42375-3389 |
| 15 | 42375-3372 | 33 | 42375-3390 |
| 16 | 42375-3373 | 34 | 42375-3391 |
| 17 | 42375-3374 | 35 | 42375-3392 |
| 18 | 42375-3375 | 36 | 42375-3393 |
| 19 | 42375-3376 | | |

| ENG. NO: 42375-3394 / 3428 | | | |
|----------------------------|-------------|--------------------|-------------|
| HEADER NUMBER: | | 42312-0036 | |
| PIN NUMBER: | | 42663-EZB208 | |
| PIN LENGTH: L | | .970/24.64 | |
| MATING LENGTH: M | | .780/19.81 | |
| GOLD POINT: G | | .200/5.08 | |
| PC TAIL LENGTH: P | | .100/ 2.54 | |
| TIN: T | | .200/5.08 | |
| CKTS: | | 2-36 | |
| KINKS: | | NO | |
| VOIDED CKTS: | | NONE | |
| PACKAGING: | | BULK PK-40873-0043 | |
| CKTS | ITEM NUMBER | CKTS | ITEM NUMBER |
| 2 | 42375-3394 | 20 | 42375-3412 |
| 3 | 42375-3395 | 21 | 42375-3413 |
| 4 | 42375-3396 | 22 | 42375-3414 |
| 5 | 42375-3397 | 23 | 42375-3415 |
| 6 | 42375-3398 | 24 | 42375-3416 |
| 7 | 42375-3399 | 25 | 42375-3417 |
| 8 | 42375-3400 | 26 | 42375-3418 |
| 9 | 42375-3401 | 27 | 42375-3419 |
| 10 | 42375-3402 | 28 | 42375-3420 |
| 11 | 42375-3403 | 29 | 42375-3421 |
| 12 | 42375-3404 | 30 | 42375-3422 |
| 13 | 42375-3405 | 31 | 42375-3423 |
| 14 | 42375-3406 | 32 | 42375-3424 |
| 15 | 42375-3407 | 33 | 42375-3425 |
| 16 | 42375-3408 | 34 | 42375-3426 |
| 17 | 42375-3409 | 35 | 42375-3427 |
| 18 | 42375-3410 | 36 | 42375-3428 |
| 19 | 42375-3411 | | |

| ENG. NO: 42375-3429 / 3463 | | | |
|----------------------------|-------------|--------------------|-------------|
| HEADER NUMBER: | | 42312-0036 | |
| PIN NUMBER: | | 42663-ARA154 | |
| PIN LENGTH: L | | .520/13.21 | |
| MATING LENGTH: M | | .386/9.80 | |
| GOLD POINT: G | | N/A | |
| PC TAIL LENGTH: P | | .044/1.12 | |
| TIN: T | | OVERALL | |
| CKTS: | | 2-36 | |
| KINKS: | | NO | |
| VOIDED CKTS: | | NONE | |
| PACKAGING: | | BULK PK-40873-0041 | |
| CKTS | ITEM NUMBER | CKTS | ITEM NUMBER |
| 2 | 42375-3429 | 20 | 42375-3447 |
| 3 | 42375-3430 | 21 | 42375-3448 |
| 4 | 42375-3431 | 22 | 42375-3449 |
| 5 | 42375-3432 | 23 | 42375-3450 |
| 6 | 42375-3433 | 24 | 42375-3451 |
| 7 | 42375-3434 | 25 | 42375-3452 |
| 8 | 42375-3435 | 26 | 42375-3453 |
| 9 | 42375-3436 | 27 | 42375-3454 |
| 10 | 42375-3437 | 28 | 42375-3455 |
| 11 | 42375-3438 | 29 | 42375-3456 |
| 12 | 42375-3439 | 30 | 42375-3457 |
| 13 | 42375-3440 | 31 | 42375-3458 |
| 14 | 42375-3441 | 32 | 42375-3459 |
| 15 | 42375-3442 | 33 | 42375-3460 |
| 16 | 42375-3443 | 34 | 42375-3461 |
| 17 | 42375-3444 | 35 | 42375-3462 |
| 18 | 42375-3445 | 36 | 42375-3463 |
| 19 | 42375-3446 | | |

| | | | | |
|-----------------|----|--------------|------------|----------|
| DOCUMENT STATUS | P1 | RELEASE DATE | 2021/12/20 | 12:18:33 |
|-----------------|----|--------------|------------|----------|

| SYMBOLS  = 0  = 0  = 0  = 0  = 0  = 0  = 0  = 0 | THIS DRAWING CONTAINS INFORMATION THAT IS PROPRIETARY TO MOLEX ELECTRONIC TECHNOLOGIES, LLC AND SHOULD NOT BE USED WITHOUT WRITTEN PERMISSION DIMENSION UNITS: MM/IN SCALE: 1:1 | CURRENT REV DESC: GOLD LENGTH SPEC CHANGED AS MIN 2.54- MAX 5.54 FOR A-42375-0037/0071 EC NO: 689596 DRWN: SHRUTJ 2021/09/14 CHK'D: SHRUTJ 2021/12/20 APPR: ISHWARG 2021/12/20 |  KK 100 HEADER ASSY FLAT VERTICAL BREAKAWAY PRODUCT CUSTOMER DRAWING DOCUMENT NUMBER: SD-42375-001 DOC TYPE: PSD DOC PART: 001 REVISION: V MATERIAL NUMBER: SEE CHART CUSTOMER: GENERAL MARKET SHEET NUMBER: 23 OF 35 | | | | | | | | | | | | | | | | | | |
|--|---|--|---|----------------------------------|------|------------|--|--|------------|--|--------|------------|--------|---|-----------|--------|---|------------|--|--|---|
| | GENERAL TOLERANCES (UNLESS SPECIFIED) <table border="1"> <tr> <th></th> <th>MM</th> <th>INCH</th> </tr> <tr> <td>4 PLACES ±</td> <td></td> <td></td> </tr> <tr> <td>3 PLACES ±</td> <td></td> <td>± 0.01</td> </tr> <tr> <td>2 PLACES ±</td> <td>± 0.25</td> <td>±</td> </tr> <tr> <td>1 PLACE ±</td> <td>± 0.38</td> <td>±</td> </tr> <tr> <td>0 PLACES ±</td> <td></td> <td></td> </tr> </table> | | | MM | INCH | 4 PLACES ± | | | 3 PLACES ± | | ± 0.01 | 2 PLACES ± | ± 0.25 | ± | 1 PLACE ± | ± 0.38 | ± | 0 PLACES ± | | | INITIAL REVISION: DRWN: SCHAFFER 2003/02/11 APPR: MARGULIS 2004/02/27 |
| | | MM | | INCH | | | | | | | | | | | | | | | | | |
| | 4 PLACES ± | | | | | | | | | | | | | | | | | | | | |
| | 3 PLACES ± | | | ± 0.01 | | | | | | | | | | | | | | | | | |
| | 2 PLACES ± | ± 0.25 | | ± | | | | | | | | | | | | | | | | | |
| | 1 PLACE ± | ± 0.38 | | ± | | | | | | | | | | | | | | | | | |
| | 0 PLACES ± | | | | | | | | | | | | | | | | | | | | |
| | ANGULAR TOL ± 0.5° DRAFT WHERE APPLICABLE MUST REMAIN WITHIN DIMENSIONS | THIRD ANGLE PROJECTION  | | DRAWING: B-SIZE SERIES: 42375 | | | | | | | | | | | | | | | | | |

| ENG. NO: 42375-3464 / 3498 | | | |
|----------------------------|--------------|--------------------|--------------|
| HEADER NUMBER: | | 42312-0036 | |
| PIN NUMBER: | | 42663-CJA154 | |
| PIN LENGTH: L | | .700/17.78 | |
| MATING LENGTH: M | | .500/12.70 | |
| GOLD POINT: G | | N/A | |
| PC TAIL LENGTH: P | | 110/2.79 | |
| TIN: T | | OVERALL | |
| CKTS: | | 2-36 | |
| KINKS: | | NO | |
| VOIDED CKTS: | | #2 | |
| PACKAGING: | | BULK PK-40873-0041 | |
| CKTS | ITEM NUMBER | CKTS | ITEM NUMBER |
| 2 | 42375-3464 | 20 | 42375-3482 |
| 3 | 42375-3465 | 21 | 42375-3483 |
| 4 | 42375-3466 | 22 | 42375-3484 |
| 5 | 42375-3467 | 23 | 42375-3480 5 |
| 6 | 42375-3468 | 24 | 42375-3486 |
| 7 | 42375-3469 | 25 | 42375-3487 |
| 8 | 42375-3470 | 26 | 42375-3488 |
| 9 | 42375-3471 | 27 | 42375-3489 |
| 10 | 42375-3472 | 28 | 42375-34890 |
| 11 | 42375-3473 | 29 | 42375-3491 |
| 12 | 42375-3474 | 30 | 42375-3492 |
| 13 | 42375-3475 | 31 | 42375-3493 |
| 14 | 42375-3476 | 32 | 42375-3494 |
| 15 | 42375-3470 7 | 33 | 42375-3495 |
| 16 | 42375-3478 | 34 | 42375-3496 |
| 17 | 42375-3479 | 35 | 42375-3497 |
| 18 | 42375-3480 | 36 | 42375-3498 |
| 19 | 42375-3481 | | |

| ENG. NO: 42375-3499/3533 | | | |
|--------------------------|-------------|--------------------|-------------|
| HEADER NUMBER: | | 42312-0036 | |
| PIN NUMBER: | | 42663-ETA154 | |
| PIN LENGTH: L | | .950/24.13 | |
| MATING LENGTH: M | | .750/19.05 | |
| GOLD POINT: G | | N/A | |
| PC TAIL LENGTH: P | | 110/2.79 | |
| TIN: T | | OVERALL | |
| CKTS: | | 2-36 | |
| KINKS: | | NO | |
| VOIDED CKTS: | | NONE | |
| PACKAGING: | | BULK PK-40873-0043 | |
| CKTS | ITEM NUMBER | CKTS | ITEM NUMBER |
| 2 | 42375-3499 | 20 | 42375-3517 |
| 3 | 42375-3500 | 21 | 42375-3518 |
| 4 | 42375-3501 | 22 | 42375-3519 |
| 5 | 42375-3502 | 23 | 42375-3520 |
| 6 | 42375-3503 | 24 | 42375-3521 |
| 7 | 42375-3504 | 25 | 42375-3522 |
| 8 | 42375-3505 | 26 | 42375-3523 |
| 9 | 42375-3506 | 27 | 42375-3524 |
| 10 | 42375-3507 | 28 | 42375-3525 |
| 11 | 42375-3508 | 29 | 42375-3526 |
| 12 | 42375-3509 | 30 | 42375-3527 |
| 13 | 42375-3510 | 31 | 42375-3528 |
| 14 | 42375-3511 | 32 | 42375-3529 |
| 15 | 42375-3512 | 33 | 42375-3530 |
| 16 | 42375-3513 | 34 | 42375-3531 |
| 17 | 42375-3514 | 35 | 42375-3532 |
| 18 | 42375-3515 | 36 | 42375-3533 |
| 19 | 42375-3516 | | |

| ENG. NO: 42375-3534/3568 | | | |
|--------------------------|-------------|--------------------|-------------|
| HEADER NUMBER: | | 42312-0036 | |
| PIN NUMBER: | | 42663-AWB208 | |
| PIN LENGTH: L | | .535/13.59 | |
| MATING LENGTH: M | | .235/5.97 | |
| GOLD POINT: G | | .200/5.08 | |
| PC TAIL LENGTH: P | | .210/5.33 | |
| TIN: T | | .100/2.54 | |
| CKTS: | | 2-36 | |
| KINKS: | | NO | |
| VOIDED CKTS: | | NONE | |
| PACKAGING: | | BULK PK-40873-0041 | |
| CKTS | ITEM NUMBER | CKTS | ITEM NUMBER |
| 2 | 42375-3534 | 20 | 42375-3572 |
| 3 | 42375-3535 | 21 | 42375-3573 |
| 4 | 42375-3536 | 22 | 42375-3574 |
| 5 | 42375-3537 | 23 | 42375-3575 |
| 6 | 42375-3538 | 24 | 42375-3576 |
| 7 | 42375-3539 | 25 | 42375-3577 |
| 8 | 42375-3560 | 26 | 42375-3578 |
| 9 | 42375-3561 | 27 | 42375-3579 |
| 10 | 42375-3562 | 28 | 42375-3580 |
| 11 | 42375-3563 | 29 | 42375-3581 |
| 12 | 42375-3564 | 30 | 42375-3582 |
| 13 | 42375-3565 | 31 | 42375-3583 |
| 14 | 42375-3566 | 32 | 42375-3584 |
| 15 | 42375-3567 | 33 | 42375-3585 |
| 16 | 42375-3568 | 34 | 42375-3586 |
| 17 | 42375-3569 | 35 | 42375-3587 |
| 18 | 42375-3570 | 36 | 42375-3588 |
| 19 | 42375-3571 | | |

| | | | | |
|---|---|--|---|---|
| SYMBOLS = 0 = 0 = 0 = 0 = 0 = 0 = 0 = 0 = 0 | THIS DRAWING CONTAINS INFORMATION THAT IS PROPRIETARY TO MOLEX ELECTRONIC TECHNOLOGIES, LLC AND SHOULD NOT BE USED WITHOUT WRITTEN PERMISSION DIMENSION UNITS: MM/IN SCALE: 1:1 | CURRENT REV DESC: GOLD LENGTH SPEC CHANGED AS MIN 2.54- MAX 5.54 FOR A-42375-0037/0071 EC NO: 689596 DRWN: SHRUTJ 2021/09/14 CHK'D: SHRUTJ 2021/12/20 APPR: ISHWARG 2021/12/20 | KK 100 HEADER ASSY FLAT VERTICAL BREAKAWAY PRODUCT CUSTOMER DRAWING | |
| | GENERAL TOLERANCES (UNLESS SPECIFIED) | INITIAL REVISION: DRWN: SCHAFFER 2003/02/11 APPR: MARGULIS 2004/02/27 | | DOCUMENT NUMBER: SD-42375-001 DOC TYPE: PSD DOC PART: 001 REVISION: V |
| | ANGULAR TOL ± 0.5° DRAFT WHERE APPLICABLE MUST REMAIN WITHIN DIMENSIONS | THIRD ANGLE PROJECTION | | SERIES: 42375 MATERIAL NUMBER: SEE CHART CUSTOMER: GENERAL MARKET SHEET NUMBER: 24 OF 35 |
| | | DRAWING: B-SIZE DIMENSION UNITS: MM/IN | | |

| ENG. NO: A-42375-3569/3603 | | | | | |
|----------------------------|-----------------|--------------------|------|-----------------|------------|
| HEADER NUMBER: | | 42312-0036 | | | |
| PIN NUMBER: | | 42663-ABB208 | | | |
| PIN LENGTH: L | | .530 / 13.46 | | | |
| MATING LENGTH: M | | .240 / 6.09 | | | |
| GOLD POINT: G | | .100 / 2.54 | | | |
| PC TAIL LENGTH: P | | .125 / 3.18 | | | |
| TIN: T | | .100 / 2.54 | | | |
| CKTS: | | 4-36 | | | |
| KINKS: | | NO | | | |
| VOIDED CKTS: | | 5 | | | |
| PACKAGING: | | BULK PK-40873-0041 | | | |
| CKTS | MATERIAL NUMBER | ENG NUMBER | CKTS | MATERIAL NUMBER | ENG NUMBER |
| 2 | | | 20 | 423753587 | 42375-3587 |
| 3 | | | 21 | 423753588 | 42375-3588 |
| 4 | | | 22 | 423753589 | 42375-3589 |
| 5 | 423753572 | 42375-3572 | 23 | 423753590 | 42375-3590 |
| 6 | 423753573 | 42375-3573 | 24 | 423753591 | 42375-3591 |
| 7 | 423753574 | 42375-3574 | 25 | 423753592 | 42375-3592 |
| 8 | 423753575 | 42375-3575 | 26 | 423753593 | 42375-3593 |
| 9 | 423753576 | 42375-3576 | 27 | 423753594 | 42375-3594 |
| 10 | 423753577 | 42375-3577 | 28 | 423753595 | 42375-3595 |
| 11 | 423753578 | 42375-3578 | 29 | 423753596 | 42375-3596 |
| 12 | 423753579 | 42375-3579 | 30 | 423753597 | 42375-3597 |
| 13 | 423753580 | 42375-3580 | 31 | 423753598 | 42375-3598 |
| 14 | 423753581 | 42375-3581 | 32 | 423753599 | 42375-3599 |
| 15 | 423753582 | 42375-3582 | 33 | 423753600 | 42375-3600 |
| 16 | 423753583 | 42375-3583 | 34 | 423753601 | 42375-3601 |
| 17 | 423753584 | 42375-3584 | 35 | 423753602 | 42375-3602 |
| 18 | 423753585 | 42375-3585 | 36 | 423753603 | 42375-3603 |
| 19 | 423753586 | 42375-3586 | | | |

| ENG. NO: A-42375-2974/3008 | | | | | |
|----------------------------|-----------------|--------------------|------|-----------------|-------------|
| HEADER NUMBER: | | 42312-0036 | | | |
| PIN NUMBER: | | 42663-FKB228 | | | |
| PIN LENGTH: L | | 1.020 / 25.91 | | | |
| MATING LENGTH: M | | .805 / 20.45 | | | |
| GOLD POINT: G | | .200 / 5.08 | | | |
| PC TAIL LENGTH: P | | .125 / 3.18 | | | |
| TIN: T | | .200 / 5.08 | | | |
| CKTS: | | 2-36 | | | |
| KINKS: | | NO | | | |
| VOIDED CKTS: | | NONE | | | |
| PACKAGING: | | BULK PK-40873-0043 | | | |
| CKTS | MATERIAL NUMBER | ENG NUMBER | CKTS | MATERIAL NUMBER | ITEM NUMBER |
| 2 | | | 20 | | |
| 3 | | | 21 | | |
| 4 | | | 22 | | |
| 5 | 423752977 | 42375-2977 | 23 | | |
| 6 | | | 24 | | |
| 7 | | | 25 | | |
| 8 | | | 26 | | |
| 9 | | | 27 | | |
| 10 | | | 28 | | |
| 11 | | | 29 | | |
| 12 | | | 30 | | |
| 13 | | | 31 | | |
| 14 | | | 32 | | |
| 15 | | | 33 | | |
| 16 | | | 34 | | |
| 17 | | | 35 | | |
| 18 | | | 36 | | |
| 19 | | | | | |

DOCUMENT STATUS | P1 | RELEASE DATE | 2021/12/20 12:18:33

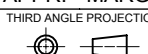
| | | | | | |
|---------|---|--------|--|-------------------------|--------------|
| SYMBOLS | THIS DRAWING CONTAINS INFORMATION THAT IS PROPRIETARY TO MOLEX ELECTRONIC TECHNOLOGIES, LLC AND SHOULD NOT BE USED WITHOUT WRITTEN PERMISSION | | | | |
| | DIMENSION UNITS | SCALE | CURRENT REV DESC: GOLD LENGTH SPEC CHANGED AS MIN 2.54- MAX 5.54 FOR A-42375-0037/0071 | | |
| ▽ = 0 | MM/IN | 1:1 |  KK 100 HEADER ASSY FLAT VERTICAL BREAKAWAY | | |
| ▽ = 0 | GENERAL TOLERANCES (UNLESS SPECIFIED) | | | | |
| ▽ = 0 | | | PRODUCT CUSTOMER DRAWING | | |
| ▽ = 0 | 4 PLACES ± | | EC NO: 689596 | DRWN: SHRUTJ 2021/09/14 | |
| ▽ = 0 | 3 PLACES ± | ± 0.01 | CHK'D: SHRUTJ | 2021/12/20 | |
| ▽ = 0 | 2 PLACES ± | ± 0.25 | APPR: ISHWARG | 2021/12/20 | |
| ▽ = 0 | 1 PLACE ± | ± 0.38 | INITIAL REVISION: | | |
| ▽ = 0 | 0 PLACES ± | | DRWN: SCHAFFER | 2003/02/11 | |
| ▽ = 0 | ANGULAR TOL ± | ± 0.5° | APPR: MARGULIS | 2004/02/27 | |
| ▽ = 0 | DRAFT WHERE APPLICABLE MUST REMAIN WITHIN DIMENSIONS | | THIRD ANGLE PROJECTION | DRAWING | SERIES |
| ▽ = 0 | | |  | B-SIZE | 42375 |
| | | | DOCUMENT NUMBER | DOC TYPE | DOC PART |
| | | | SD-42375-001 | PSD | 001 |
| | | | MATERIAL NUMBER | CUSTOMER | SHEET NUMBER |
| | | | SEE CHART | GENERAL MARKET | 25 OF 35 |

| ENG. NO: A-42375-3604/3637 | | | | | |
|----------------------------|-----------------|--------------------|------|-----------------|------------|
| HEADER NUMBER: | | 42312-0036 | | | |
| PIN NUMBER: | | 42663-AXA154 | | | |
| PIN LENGTH: L | | .540 / 13.72 | | | |
| MATING LENGTH: M | | .380 / 9.65 | | | |
| GOLD POINT: G | | N/A | | | |
| PC TAIL LENGTH: P | | .070 / 1.78 | | | |
| TIN: T | | OVERALL | | | |
| CKTS: | | 2-36 | | | |
| KINKS: | | NO | | | |
| VOIDED CKTS: | | 2 | | | |
| PACKAGING: | | BULK PK-40873-0041 | | | |
| CKTS | MATERIAL NUMBER | ENG NUMBER | CKTS | MATERIAL NUMBER | ENG NUMBER |
| 2 | | | 20 | | |
| 3 | 42375-3604 | | 21 | | |
| 4 | | | 22 | | |
| 5 | | | 23 | | |
| 6 | | | 24 | | |
| 7 | | | 25 | | |
| 8 | | | 26 | | |
| 9 | | | 27 | | |
| 10 | | | 28 | | |
| 11 | | | 29 | | |
| 12 | | | 30 | | |
| 13 | | | 31 | | |
| 14 | | | 32 | | |
| 15 | | | 33 | | |
| 16 | | | 34 | | |
| 17 | | | 35 | | |
| 18 | | | 36 | | |
| 19 | | | | | |

| ENG. NO: A-42375-3638/3658 | | | | | |
|----------------------------|-----------------|----------------------------|------|-----------------|-------------|
| HEADER NUMBER: | | 42312-0036 | | | |
| PIN NUMBER: | | 42663-ABA154 | | | |
| PIN LENGTH: L | | .455 / 11.56 | | | |
| MATING LENGTH: M | | .240 / 6.09 | | | |
| GOLD POINT: G | | N/A | | | |
| PC TAIL LENGTH: P | | .125 / 3.18 | | | |
| TIN: T | | OVERALL | | | |
| CKTS: | | 2-36 | | | |
| KINKS: | | NO | | | |
| VOIDED CKTS: | | 2, 4, 6, 8, 10, 12, 14, 16 | | | |
| PACKAGING: | | BULK PK-40873-0041 | | | |
| CKTS | MATERIAL NUMBER | ENG NUMBER | CKTS | MATERIAL NUMBER | ITEM NUMBER |
| 2 | | | 20 | | |
| 3 | | | 21 | | |
| 4 | | | 22 | | |
| 5 | | | 23 | | |
| 6 | | | 24 | | |
| 7 | | | 25 | | |
| 8 | | | 26 | | |
| 9 | | | 27 | | |
| 10 | | | 28 | | |
| 11 | | | 29 | | |
| 12 | | | 30 | | |
| 13 | | | 31 | | |
| 14 | | | 32 | | |
| 15 | | | 33 | | |
| 16 | | | 34 | | |
| 17 | 423753639 | 42375-3639 | 35 | | |
| 18 | | | 36 | | |
| 19 | | | | | |

| | | | | | |
|-----------------|---|--------|------------------------|--|---------------------|
| SYMBOLS | THIS DRAWING CONTAINS INFORMATION THAT IS PROPRIETARY TO MOLEX ELECTRONIC TECHNOLOGIES, LLC AND SHOULD NOT BE USED WITHOUT WRITTEN PERMISSION | | | | |
| | DIMENSION UNITS | SCALE | | CURRENT REV DESC: GOLD LENGTH SPEC CHANGED AS MIN 2.54- MAX 5.54 FOR A-42375-0037/0071 | |
| | | MM/IN | 1:1 | | |
| | GENERAL TOLERANCES (UNLESS SPECIFIED) | | | | |
| | | MM | INCH | EC NO: 689596 | |
| | 4 PLACES | ± | ± | DRWN: SHRUTJ 2021/09/14 | |
| | 3 PLACES | ± | ± 0.01 | CHK'D: SHRUTJ 2021/12/20 | |
| | 2 PLACES | ± 0.25 | ± | APPR: ISHWARG 2021/12/20 | |
| | 1 PLACE | ± 0.38 | ± | INITIAL REVISION: | |
| | 0 PLACES | ± | ± | DRWN: SCHAFFER 2003/02/11 | |
| | ANGULAR TOL | | ± 0.5° | APPR: MARGULIS 2004/02/27 | |
| | DRAFT WHERE APPLICABLE MUST REMAIN WITHIN DIMENSIONS | | THIRD ANGLE PROJECTION | DRAWING | SERIES |
| | | | | B-SIZE | 42375 |
| DOCUMENT STATUS | | | P1 | RELEASE DATE | 2021/12/20 12:18:33 |
| DOCUMENT NUMBER | | | SD-42375-001 | DOC TYPE | PSD |
| DOC PART | | | 001 | REVISION | V |
| MATERIAL NUMBER | | | SEE CHART | CUSTOMER | GENERAL MARKET |
| SHEET NUMBER | | | 26 OF 35 | | |

molex

KK 100 HEADER ASSY
FLAT VERTICAL BREAKAWAY

PRODUCT CUSTOMER DRAWING

| ENG. NO: 42375-3659/3693 | | | | | |
|--------------------------|-----------------|--------------------|------|-----------------|------------|
| HEADER NUMBER: | | 42312-0036 | | | |
| PIN NUMBER: | | 42663-AXB208 | | | |
| PIN LENGTH: L | | .540 / 13.72 | | | |
| MATING LENGTH: M | | .250 / 6.35 | | | |
| GOLD POINT: G | | .140 / 3.56 | | | |
| PC TAIL LENGTH: P | | .200 / 5.08 | | | |
| TIN: T | | .135 / 3.43 | | | |
| CKTS: | | 2-36 | | | |
| KINKS: | | NO | | | |
| VOIDED CKTS: | | NONE | | | |
| PACKAGING: | | BULK PK-40873-0041 | | | |
| CKTS | MATERIAL NUMBER | ENG NUMBER | CKTS | MATERIAL NUMBER | ENG NUMBER |
| 2 | 68300-2000 | 42375-3659 | 20 | | 42375-3677 |
| 3 | 68300-2001 | 42375-3660 | 21 | | 42375-3678 |
| 4 | | 42375-3661 | 22 | | 42375-3679 |
| 5 | 68300-2006 | 42375-3662 | 23 | | 42375-3680 |
| 6 | | 42375-3663 | 24 | | 42375-3681 |
| 7 | | 42375-3664 | 25 | | 42375-3682 |
| 8 | | 42375-3665 | 26 | | 42375-3683 |
| 9 | | 42375-3666 | 27 | | 42375-3684 |
| 10 | | 42375-3667 | 28 | | 42375-3685 |
| 11 | | 42375-3668 | 29 | | 42375-3686 |
| 12 | | 42375-3669 | 30 | | 42375-3687 |
| 13 | | 42375-3670 | 31 | | 42375-3688 |
| 14 | | 42375-3671 | 32 | | 42375-3689 |
| 15 | | 42375-3672 | 33 | | 42375-3690 |
| 16 | | 42375-3673 | 34 | | 42375-3691 |
| 17 | | 42375-3674 | 35 | | 42375-3692 |
| 18 | | 42375-3675 | 36 | | 42375-3693 |
| 19 | | 42375-3676 | | | |

| ENG. NO: 42375-3694/3728 | | | | | |
|--------------------------|-----------------|--------------------|------|-----------------|------------|
| HEADER NUMBER: | | 42312-0036 | | | |
| PIN NUMBER: | | 42663-AXB208 | | | |
| PIN LENGTH: L | | .540 / 13.72 | | | |
| MATING LENGTH: M | | .250 / 6.35 | | | |
| GOLD POINT: G | | .140 / 3.56 | | | |
| PC TAIL LENGTH: P | | .200 / 5.08 | | | |
| TIN: T | | .135 / 3.43 | | | |
| CKTS: | | 2-36 | | | |
| KINKS: | | NO | | | |
| VOIDED CKTS: | | 5 | | | |
| PACKAGING: | | BULK PK-40873-0041 | | | |
| CKTS | MATERIAL NUMBER | ENG NUMBER | CKTS | MATERIAL NUMBER | ENG NUMBER |
| 2 | | 42375-3694 | 20 | | 42375-3712 |
| 3 | | 42375-3695 | 21 | | 42375-3713 |
| 4 | | 42375-3696 | 22 | | 42375-3714 |
| 5 | | 42375-3697 | 23 | | 42375-3715 |
| 6 | | 42375-3698 | 24 | | 42375-3716 |
| 7 | | 42375-3699 | 25 | | 42375-3717 |
| 8 | 68300-2002 | 42375-3700 | 26 | | 42375-3718 |
| 9 | | 42375-3701 | 27 | | 42375-3719 |
| 10 | | 42375-3702 | 28 | | 42375-3720 |
| 11 | | 42375-3703 | 29 | | 42375-3721 |
| 12 | | 42375-3704 | 30 | | 42375-3722 |
| 13 | | 42375-3705 | 31 | | 42375-3723 |
| 14 | | 42375-3706 | 32 | | 42375-3724 |
| 15 | | 42375-3707 | 33 | | 42375-3725 |
| 16 | | 42375-3708 | 34 | | 42375-3726 |
| 17 | | 42375-3709 | 35 | | 42375-3727 |
| 18 | | 42375-3710 | 36 | | 42375-3728 |
| 19 | | 42375-3711 | | | |

| | | | |
|---------|---|---------|--|
| SYMBOLS | THIS DRAWING CONTAINS INFORMATION THAT IS PROPRIETARY TO MOLEX ELECTRONIC TECHNOLOGIES, LLC AND SHOULD NOT BE USED WITHOUT WRITTEN PERMISSION | | |
| | DIMENSION UNITS | SCALE | CURRENT REV DESC: GOLD LENGTH SPEC CHANGED AS MIN 2.54- MAX 5.54 FOR A-42375-0037/0071 |
| ∇ = 0 | MM/IN | 1:1 |  KK 100 HEADER ASSY FLAT VERTICAL BREAKAWAY |
| ∇ = 0 | GENERAL TOLERANCES (UNLESS SPECIFIED) | | |
| ∇ = 0 | | | EC NO: 689596 DRWN: SHRUTJ 2021/09/14 CHK'D: SHRUTJ 2021/12/20 APPR: ISHWARG 2021/12/20 |
| ∇ = 0 | 4 PLACES ± | ± | |
| ∇ = 0 | 3 PLACES ± | ± 0.01 | PRODUCT CUSTOMER DRAWING DOCUMENT NUMBER: SD-42375-001 DOC TYPE: PSD DOC PART: 001 REVISION: V |
| ∇ = 0 | 2 PLACES ± | ± 0.25 | |
| ∇ = 0 | 1 PLACE ± | ± 0.38 | INITIAL REVISION: DRWN: SCHAFFER 2003/02/11 APPR: MARGULIS 2004/02/27 |
| ∇ = 0 | 0 PLACES ± | ± | |
| ∇ = 0 | ANGULAR TOL ± 0.5° | | MATERIAL NUMBER: SEE CHART CUSTOMER: GENERAL MARKET SHEET NUMBER: 27 OF 35 |
| ∇ = 0 | DRAFT WHERE APPLICABLE MUST REMAIN WITHIN DIMENSIONS | | |
| ∇ = 0 | THIRD ANGLE PROJECTION | DRAWING | B-SIZE 42375 |
| ∇ = 0 | | | |

| ENG. NO: 42375-3659/3693 | | | | | |
|--------------------------|-----------------|--------------------|------|-----------------|------------|
| HEADER NUMBER: | | 42312-0036 | | | |
| PIN NUMBER: | | 42663-AXB208 | | | |
| PIN LENGTH: L | | .540 / 13.72 | | | |
| MATING LENGTH: M | | .250 / 6.35 | | | |
| GOLD POINT: G | | .140 / 3.56 | | | |
| PC TAIL LENGTH: P | | .200 / 5.08 | | | |
| TIN: T | | .135 / 3.43 | | | |
| CKTS: | | 2-36 | | | |
| KINKS: | | NO | | | |
| VOIDED CKTS: | | 5 | | | |
| PACKAGING: | | BULK PK-40873-0041 | | | |
| CKTS | MATERIAL NUMBER | ENG NUMBER | CKTS | MATERIAL NUMBER | ENG NUMBER |
| 2 | | 42375-3729 | 20 | | 42375-3747 |
| 3 | | 42375-3730 | 21 | | 42375-3748 |
| 4 | | 42375-3731 | 22 | | 42375-3749 |
| 5 | | 42375-3732 | 23 | | 42375-3750 |
| 6 | | 42375-3733 | 24 | | 42375-3751 |
| 7 | | 42375-3734 | 25 | | 42375-3752 |
| 8 | 68300-2007 | 42375-3735 | 26 | | 42375-3753 |
| 9 | | 42375-3736 | 27 | | 42375-3754 |
| 10 | | 42375-3737 | 28 | | 42375-3755 |
| 11 | | 42375-3738 | 29 | | 42375-3756 |
| 12 | | 42375-3739 | 30 | | 42375-3757 |
| 13 | | 42375-3740 | 31 | | 42375-3758 |
| 14 | | 42375-3741 | 32 | | 42375-3759 |
| 15 | | 42375-3742 | 33 | | 42375-3760 |
| 16 | | 42375-3743 | 34 | | 42375-3761 |
| 17 | | 42375-3744 | 35 | | 42375-3762 |
| 18 | | 42375-3745 | 36 | | 42375-3763 |
| 19 | | 42375-3746 | | | |

| ENG. NO: 42375-3764/3798 | | | |
|--------------------------|-------------|--------------------|-------------|
| HEADER NUMBER: | | 42312-0036 | |
| PIN NUMBER: | | 42663-ETA154 | |
| PIN LENGTH: L | | .540 / 13.72 | |
| MATING LENGTH: M | | .250 / 6.35 | |
| GOLD POINT: G | | .140 / 3.56 | |
| PC TAIL LENGTH: P | | .200 / 5.08 | |
| TIN: T | | .135 / 3.43 | |
| CKTS: | | 2-36 | |
| KINKS: | | NO | |
| VOIDED CKTS: | | 5 | |
| PACKAGING: | | BULK PK-40873-0041 | |
| CKTS | ITEM NUMBER | CKTS | ITEM NUMBER |
| 2 | | 20 | |
| 3 | | 21 | |
| 4 | | 22 | |
| 5 | | 23 | |
| 6 | | 24 | |
| 7 | | 25 | |
| 8 | 68300-2007 | 26 | |
| 9 | | 27 | |
| 10 | | 28 | |
| 11 | | 29 | |
| 12 | | 30 | |
| 13 | | 31 | |
| 14 | | 32 | |
| 15 | | 33 | |
| 16 | | 34 | |
| 17 | | 35 | |
| 18 | | 36 | |
| 19 | | | |

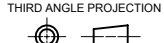
| | | | |
|---------|---|---------|--|
| SYMBOLS | THIS DRAWING CONTAINS INFORMATION THAT IS PROPRIETARY TO MOLEX ELECTRONIC TECHNOLOGIES, LLC AND SHOULD NOT BE USED WITHOUT WRITTEN PERMISSION | | |
| | DIMENSION UNITS | SCALE | CURRENT REV DESC: GOLD LENGTH SPEC CHANGED AS MIN 2.54- MAX 5.54 FOR A-42375-0037/0071 |
| ∇ = 0 | MM/IN | 1:1 |  KK 100 HEADER ASSY FLAT VERTICAL BREAKAWAY |
| ∇ = 0 | GENERAL TOLERANCES (UNLESS SPECIFIED) | | |
| ∇ = 0 | | | EC NO: 689596 DRWN: SHRUTJ 2021/09/14 CHK'D: SHRUTJ 2021/12/20 APPR: ISHWARG 2021/12/20 |
| ∇ = 0 | 4 PLACES ± | ± | |
| ∇ = 0 | 3 PLACES ± | ± 0.01 | PRODUCT CUSTOMER DRAWING DOCUMENT NUMBER: SD-42375-001 DOC TYPE: PSD DOC PART: 001 REVISION: V |
| ∇ = 0 | 2 PLACES ± | ± 0.25 | |
| ∇ = 0 | 1 PLACE ± | ± 0.38 | INITIAL REVISION: DRWN: SCHAFFER 2003/02/11 APPR: MARGULIS 2004/02/27 |
| ∇ = 0 | 0 PLACES ± | ± | |
| ∇ = 0 | ANGULAR TOL ± 0.5° | | MATERIAL NUMBER: SEE CHART CUSTOMER: GENERAL MARKET SHEET NUMBER: 28 OF 35 |
| ∇ = 0 | DRAFT WHERE APPLICABLE MUST REMAIN WITHIN DIMENSIONS | | |
| ∇ = 0 | THIRD ANGLE PROJECTION | DRAWING | B-SIZE 42375 |
| ∇ = 0 |  | | |

| ENG. NO: 42375-3799/3832 | | | |
|--------------------------|-----------------|--------------------|-----------------|
| HEADER NUMBER: | | 42312-0036 | |
| PIN NUMBER: | | 42663-ABA154 | |
| PIN LENGTH: L | | .455 / 11.56 | |
| MATING LENGTH: M | | .240 / 6.09 | |
| GOLD POINT: G | | N/A | |
| PC TAIL LENGTH: P | | .125 / 3.18 | |
| TIN: T | | OVERALL | |
| CKTS: | | 3-36 | |
| KINKS: | | NO | |
| VOIDED CKTS: | | 3 | |
| PACKAGING: | | BULK PK-40873-0041 | |
| CKTS | MATERIAL NUMBER | CKTS | MATERIAL NUMBER |
| 2 | | 20 | |
| 3 | | 21 | |
| 4 | | 22 | |
| 5 | 42375-3801 | 23 | |
| 6 | | 24 | |
| 7 | | 25 | |
| 8 | | 26 | |
| 9 | | 27 | |
| 10 | | 28 | |
| 11 | | 29 | |
| 12 | | 30 | |
| 13 | | 31 | |
| 14 | | 32 | |
| 15 | | 33 | |
| 16 | | 34 | |
| 17 | | 35 | |
| 18 | | 36 | |
| 19 | | | |

| ENG. NO: 42375-3733/3867 | | | |
|--------------------------|-----------------|--------------------|-----------------|
| HEADER NUMBER: | | 42312-0036 | |
| PIN NUMBER: | | 42663-ABB208 | |
| PIN LENGTH: L | | .455 / 11.56 | |
| MATING LENGTH: M | | .250 / 6.35 | |
| GOLD POINT: G | | .100 / 2.54 | |
| PC TAIL LENGTH: P | | .115 / 2.92 | |
| TIN: T | | .100 / 2.54 | |
| CKTS: | | 2-36 | |
| KINKS: | | NO | |
| VOIDED CKTS: | | NONE | |
| PACKAGING: | | BULK PK-40873-0041 | |
| CKTS | MATERIAL NUMBER | CKTS | MATERIAL NUMBER |
| 2 | | 20 | |
| 3 | | 21 | |
| 4 | | 22 | |
| 5 | 42375-3836 | 23 | |
| 6 | | 24 | |
| 7 | | 25 | |
| 8 | | 26 | |
| 9 | | 27 | |
| 10 | | 28 | |
| 11 | | 29 | |
| 12 | | 30 | |
| 13 | | 31 | |
| 14 | | 32 | |
| 15 | | 33 | |
| 16 | | 34 | |
| 17 | | 35 | |
| 18 | | 36 | |
| 19 | | | |

| ENG. NO: 42375-3868 / 3902 | | | |
|----------------------------|-------------|--------------------|-------------|
| HEADER NUMBER: | | 42312-0036 | |
| PIN NUMBER: | | 42663-DWA154 | |
| PIN LENGTH: L | | .850 / 21.59 | |
| MATING LENGTH: M | | .640 / 16.26 | |
| GOLD POINT: G | | N/A | |
| PC TAIL LENGTH: P | | .120 / 3.05 | |
| TIN: T | | OVERALL | |
| CKTS: | | 2-36 | |
| KINKS: | | NO | |
| VOIDED CKTS: | | NONE | |
| PACKAGING: | | BULK PK-40873-0041 | |
| CKTS | ITEM NUMBER | CKTS | ITEM NUMBER |
| 2 | | 20 | |
| 3 | | 21 | |
| 4 | 42375-3870 | 22 | |
| 5 | | 23 | |
| 6 | 42375-3872 | 24 | |
| 7 | | 25 | |
| 8 | | 26 | |
| 9 | | 27 | |
| 10 | | 28 | |
| 11 | | 29 | |
| 12 | | 30 | |
| 13 | | 31 | |
| 14 | | 32 | |
| 15 | | 33 | |
| 16 | | 34 | |
| 17 | | 35 | |
| 18 | | 36 | |
| 19 | | | |

| SYMBOLS = 0 = 0 = 0 = 0 = 0 = 0 = 0 = 0 = 0 | THIS DRAWING CONTAINS INFORMATION THAT IS PROPRIETARY TO MOLEX ELECTRONIC TECHNOLOGIES, LLC AND SHOULD NOT BE USED WITHOUT WRITTEN PERMISSION | | CURRENT REV DESC: GOLD LENGTH SPEC CHANGED AS MIN 2.54- MAX 5.54 FOR A-42375-0037/0071 | | KK 100 HEADER ASSY FLAT VERTICAL BREAKAWAY PRODUCT CUSTOMER DRAWING | | | | | | | | | | | | | | | | | | |
|--|--|---|--|--|---|---|------|------------|--|--|------------|--|--------|------------|------|--|-----------|------|--|------------|--|--|---|
| | DIMENSION UNITS: MM/IN SCALE: 1:1 | | GENERAL TOLERANCES (UNLESS SPECIFIED) | | | EC NO: 689596 DRWN: SHRUTJ 2021/09/14 CHK'D: SHRUTJ 2021/12/20 APPR: ISHWARG 2021/12/20 | | | | | | | | | | | | | | | | | |
| | <table border="1"> <tr><th></th><th>MM</th><th>INCH</th></tr> <tr><td>4 PLACES ±</td><td></td><td></td></tr> <tr><td>3 PLACES ±</td><td></td><td>± 0.01</td></tr> <tr><td>2 PLACES ±</td><td>0.25</td><td></td></tr> <tr><td>1 PLACE ±</td><td>0.38</td><td></td></tr> <tr><td>0 PLACES ±</td><td></td><td></td></tr> </table> | | | MM | | | INCH | 4 PLACES ± | | | 3 PLACES ± | | ± 0.01 | 2 PLACES ± | 0.25 | | 1 PLACE ± | 0.38 | | 0 PLACES ± | | | INITIAL REVISION: DRWN: SCHAFFER 2003/02/11 APPR: MARGULIS 2004/02/27 |
| | | MM | INCH | | | | | | | | | | | | | | | | | | | | |
| | 4 PLACES ± | | | | | | | | | | | | | | | | | | | | | | |
| | 3 PLACES ± | | ± 0.01 | | | | | | | | | | | | | | | | | | | | |
| | 2 PLACES ± | 0.25 | | | | | | | | | | | | | | | | | | | | | |
| | 1 PLACE ± | 0.38 | | | | | | | | | | | | | | | | | | | | | |
| | 0 PLACES ± | | | | | | | | | | | | | | | | | | | | | | |
| | ANGULAR TOL ± 0.5° | | DRAFT WHERE APPLICABLE MUST REMAIN WITHIN DIMENSIONS | | | THIRD ANGLE PROJECTION | | | | | | | | | | | | | | | | | |
| DOCUMENT STATUS P1 RELEASE DATE 2021/12/20 12:18:33 | | DRAWING: B-SIZE SERIES: 42375 | | DOCUMENT NUMBER: SD-42375-001 DOC TYPE: PSD DOC PART: 001 REVISION: V | | | | | | | | | | | | | | | | | | | |
| MATERIAL NUMBER: SEE CHART CUSTOMER: GENERAL MARKET SHEET NUMBER: 29 OF 35 | | | | | | | | | | | | | | | | | | | | | | | |

E

E

| ENG. NO: 42375-3903/3932 | | | |
|--------------------------|-----------------|--------------------|-----------------|
| HEADER NUMBER: | | 42312-0036 | |
| PIN NUMBER: | | 42663-BSA154 | |
| PIN LENGTH: L | | .630 / 16.00 | |
| MATING LENGTH: M | | .421 / 10.69 | |
| GOLD POINT: G | | N/A | |
| PC TAIL LENGTH: P | | .119 / 3.02 | |
| TIN: T | | OVERALL | |
| CKTS: | | 7-36 | |
| KINKS: | | NO | |
| VOIDED CKTS: | | 7 | |
| PACKAGING: | | BULK PK-40873-0041 | |
| CKTS | MATERIAL NUMBER | CKTS | MATERIAL NUMBER |
| 2 | | 20 | |
| 3 | | 21 | |
| 4 | | 22 | |
| 5 | | 23 | |
| 6 | | 24 | |
| 7 | | 25 | |
| 8 | 42375-3904 | 26 | |
| 9 | | 27 | |
| 10 | | 28 | |
| 11 | | 29 | |
| 12 | | 30 | |
| 13 | | 31 | |
| 14 | | 32 | |
| 15 | | 33 | |
| 16 | | 34 | |
| 17 | | 35 | |
| 18 | | 36 | |
| 19 | | | |

| ENG. NO: 42375-3933/3964 | | | |
|--------------------------|-----------------|--------------------|-----------------|
| HEADER NUMBER: | | 42312-0036 | |
| PIN NUMBER: | | 42663-BSA154 | |
| PIN LENGTH: L | | .630 / 16.00 | |
| MATING LENGTH: M | | .405/10.29 | |
| GOLD POINT: G | | N/A | |
| PC TAIL LENGTH: P | | .135/3.43 | |
| TIN: T | | OVERALL | |
| CKTS: | | 5-36 | |
| KINKS: | | SMES-42003 | |
| VOIDED CKTS: | | 5 | |
| PACKAGING: | | BULK PK-40873-0041 | |
| CKTS | MATERIAL NUMBER | CKTS | MATERIAL NUMBER |
| 2 | | 20 | |
| 3 | | 21 | |
| 4 | | 22 | |
| 5 | | 23 | |
| 6 | | 24 | |
| 7 | | 25 | |
| 8 | | 26 | |
| 9 | 42375-3937 | 27 | |
| 10 | | 28 | |
| 11 | | 29 | |
| 12 | | 30 | |
| 13 | | 31 | |
| 14 | | 32 | |
| 15 | | 33 | |
| 16 | | 34 | |
| 17 | | 35 | |
| 18 | | 36 | |
| 19 | | | |

| ENG. NO: 42375-3965/3995 | | | |
|--------------------------|-----------------|--------------------|-----------------|
| HEADER NUMBER: | | 42312-0036 | |
| PIN NUMBER: | | 42663-BSA154 | |
| PIN LENGTH: L | | .630 / 16.00 | |
| MATING LENGTH: M | | .405/10.29 | |
| GOLD POINT: G | | N/A | |
| PC TAIL LENGTH: P | | .135/3.43 | |
| TIN: T | | OVERALL | |
| CKTS: | | 6-36 | |
| KINKS: | | SMES-42003 | |
| VOIDED CKTS: | | 4, 5, 6 | |
| PACKAGING: | | BULK PK-40873-0041 | |
| CKTS | MATERIAL NUMBER | CKTS | MATERIAL NUMBER |
| 2 | | 20 | |
| 3 | | 21 | |
| 4 | | 22 | |
| 5 | | 23 | |
| 6 | | 24 | |
| 7 | | 25 | |
| 8 | | 26 | |
| 9 | 42375-3968 | 27 | |
| 10 | | 28 | |
| 11 | | 29 | |
| 12 | | 30 | |
| 13 | | 31 | |
| 14 | | 32 | |
| 15 | | 33 | |
| 16 | | 34 | |
| 17 | | 35 | |
| 18 | | 36 | |
| 19 | | | |

D

D

C

C

B

B

A

A

| | | | | | | | | | | | | | | | | | | | | | | | | |
|---|---|---|------|--------|----------|---|--|--------|----------|---|------|---|---------|---|------|---|----------|---|--|---|--|--|--|--|
| SYMBOLS DIMENSION UNITS: MM/IN SCALE: 1:1 GENERAL TOLERANCES (UNLESS SPECIFIED) <table border="1"> <tr><td>4 PLACES</td><td>±</td><td></td><td>±</td></tr> <tr><td>3 PLACES</td><td>±</td><td></td><td>± 0.01</td></tr> <tr><td>2 PLACES</td><td>±</td><td>0.25</td><td>±</td></tr> <tr><td>1 PLACE</td><td>±</td><td>0.38</td><td>±</td></tr> <tr><td>0 PLACES</td><td>±</td><td></td><td>±</td></tr> </table> ANGULAR TOL ± 0.5° DRAFT WHERE APPLICABLE MUST REMAIN WITHIN DIMENSIONS THIRD ANGLE PROJECTION DRAWING: B-SIZE SERIES: 42375 | 4 PLACES | ± | | ± | 3 PLACES | ± | | ± 0.01 | 2 PLACES | ± | 0.25 | ± | 1 PLACE | ± | 0.38 | ± | 0 PLACES | ± | | ± | THIS DRAWING CONTAINS INFORMATION THAT IS PROPRIETARY TO MOLEX ELECTRONIC TECHNOLOGIES, LLC AND SHOULD NOT BE USED WITHOUT WRITTEN PERMISSION CURRENT REV DESC: GOLD LENGTH SPEC CHANGED AS MIN 2.54- MAX 5.54 FOR A-42375-0037/0071 EC NO: 689596 DRWN: SHRUTJ 2021/09/14 CHK'D: SHRUTJ 2021/12/20 APPR: ISHWARG 2021/12/20 INITIAL REVISION: DRWN: SCHAFFER 2003/02/11 APPR: MARGULIS 2004/02/27 | |  KK 100 HEADER ASSY FLAT VERTICAL BREAKAWAY | |
| | 4 PLACES | ± | | ± | | | | | | | | | | | | | | | | | | | | |
| | 3 PLACES | ± | | ± 0.01 | | | | | | | | | | | | | | | | | | | | |
| | 2 PLACES | ± | 0.25 | ± | | | | | | | | | | | | | | | | | | | | |
| | 1 PLACE | ± | 0.38 | ± | | | | | | | | | | | | | | | | | | | | |
| | 0 PLACES | ± | | ± | | | | | | | | | | | | | | | | | | | | |
| | PRODUCT CUSTOMER DRAWING DOCUMENT NUMBER: SD-42375-001 DOC TYPE: PSD DOC PART: 001 REVISION: V | | | | | | | | | | | | | | | | | | | | | | | |
| | MATERIAL NUMBER: SEE CHART CUSTOMER: GENERAL MARKET SHEET NUMBER: 30 OF 35 | | | | | | | | | | | | | | | | | | | | | | | |

| ENG. NO: A-42375-3996/4030 | | | |
|----------------------------|-------------|--------------------|-------------|
| HEADER NUMBER: | | 42312-0036 | |
| PIN NUMBER: | | 42663-AXA154 | |
| PIN LENGTH: L | | .540 / 13.72 | |
| MATING LENGTH: M | | .390 / 9.91 | |
| GOLD POINT: G | | N/A | |
| PC TAIL LENGTH: P | | .060 / 1.52 | |
| TIN: T | | OVERALL | |
| CKTS: | | 2-36 | |
| KINKS: | | NO | |
| VOIDED CKTS: | | NONE | |
| PACKAGING: | | BULK PK-40873-0041 | |
| CKTS | ITEM NUMBER | CKTS | ITEM NUMBER |
| 2 | | 20 | |
| 3 | | 21 | |
| 4 | | 22 | |
| 5 | | 23 | |
| 6 | 42375-4000 | 24 | |
| 7 | 42375-4001 | 25 | |
| 8 | | 26 | |
| 9 | | 27 | |
| 10 | | 28 | |
| 11 | | 29 | |
| 12 | | 30 | |
| 13 | | 31 | |
| 14 | | 32 | |
| 15 | | 33 | |
| 16 | | 34 | |
| 17 | | 35 | |
| 18 | | 36 | |
| 19 | | | |

| ENG. NO: 42375-4031/4059 | | | |
|--------------------------|-----------------|--------------------|-----------------|
| HEADER NUMBER: | | 42312-0036 | |
| PIN NUMBER: | | 42663-ABA154 | |
| PIN LENGTH: L | | .455 / 11.56 | |
| MATING LENGTH: M | | .240 / 6.09 | |
| GOLD POINT: G | | N/A | |
| PC TAIL LENGTH: P | | .125 / 3.18 | |
| TIN: T | | OVERALL | |
| CKTS: | | 8-36 | |
| KINKS: | | NO | |
| VOIDED CKTS: | | 2, 4, 6, 8 | |
| PACKAGING: | | BULK PK-40873-0041 | |
| CKTS | MATERIAL NUMBER | CKTS | MATERIAL NUMBER |
| 2 | | 20 | |
| 3 | | 21 | |
| 4 | | 22 | |
| 5 | | 23 | |
| 6 | | 24 | |
| 7 | | 25 | |
| 8 | | 26 | |
| 9 | 42375-4032 | 27 | |
| 10 | | 28 | |
| 11 | | 29 | |
| 12 | | 30 | |
| 13 | | 31 | |
| 14 | | 32 | |
| 15 | | 33 | |
| 16 | | 34 | |
| 17 | | 35 | |
| 18 | | 36 | |
| 19 | | | |

| ENG. NO: 42375-4060 / 4094 | | | |
|----------------------------|-----------------|--------------------|-----------------|
| HEADER NUMBER: | | 42312-0036 | |
| PIN NUMBER: | | 42663-CGA154 | |
| PIN LENGTH: L | | .690 / 17.53 | |
| MATING LENGTH: M | | .521 / 13.23 | |
| GOLD POINT: G | | N/A | |
| PC TAIL LENGTH: P | | .079 / 2.01 | |
| TIN: T | | OVERALL | |
| CKTS: | | 2-36 | |
| KINKS: | | NO | |
| VOIDED CKTS: | | NONE | |
| PACKAGING: | | BULK PK-40873-0041 | |
| CKTS | MATERIAL NUMBER | CKTS | MATERIAL NUMBER |
| 2 | | 20 | |
| 3 | | 21 | |
| 4 | | 22 | |
| 5 | | 23 | |
| 6 | 42375-4064 | 24 | |
| 7 | | 25 | |
| 8 | | 26 | |
| 9 | | 27 | |
| 10 | | 28 | |
| 11 | | 29 | |
| 12 | | 30 | |
| 13 | | 31 | |
| 14 | | 32 | |
| 15 | | 33 | |
| 16 | | 34 | |
| 17 | | 35 | |
| 18 | | 36 | |
| 19 | | | |

| | | | | |
|-----------------|----|--------------|------------|----------|
| DOCUMENT STATUS | P1 | RELEASE DATE | 2021/12/20 | 12:18:33 |
|-----------------|----|--------------|------------|----------|

| SYMBOLS = 0 = 0 = 0 = 0 = 0 = 0 = 0 = 0 = 0 | THIS DRAWING CONTAINS INFORMATION THAT IS PROPRIETARY TO MOLEX ELECTRONIC TECHNOLOGIES, LLC AND SHOULD NOT BE USED WITHOUT WRITTEN PERMISSION | | CURRENT REV DESC: GOLD LENGTH SPEC CHANGED AS MIN 2.54- MAX 5.54 FOR A-42375-0037/0071 | | KK 100 HEADER ASSY FLAT VERTICAL BREAKAWAY PRODUCT CUSTOMER DRAWING | | | | | | | | | | | | | | | | | | |
|---|---|--|---|--------------------------|---|--|------------------------|------------------------|----------------------|---|---|----------|---|--------|----------|--------|---|---------|--------|---|----------|---|---|
| | DIMENSION UNITS MM/IN | SCALE 1:1 | GENERAL TOLERANCES (UNLESS SPECIFIED) | | | EC NO: 689596 DRWN: SHRUTJ 2021/09/14 CHK'D: SHRUTJ 2021/12/20 APPR: ISHWARG 2021/12/20 | | | | | | | | | | | | | | | | | |
| | | | <table border="1"> <tr><th></th><th>MM</th><th>INCH</th></tr> <tr><td>4 PLACES</td><td>±</td><td>±</td></tr> <tr><td>3 PLACES</td><td>±</td><td>± 0.01</td></tr> <tr><td>2 PLACES</td><td>± 0.25</td><td>±</td></tr> <tr><td>1 PLACE</td><td>± 0.38</td><td>±</td></tr> <tr><td>0 PLACES</td><td>±</td><td>±</td></tr> </table> | | | | MM | INCH | 4 PLACES | ± | ± | 3 PLACES | ± | ± 0.01 | 2 PLACES | ± 0.25 | ± | 1 PLACE | ± 0.38 | ± | 0 PLACES | ± | ± |
| | | MM | INCH | | | | | | | | | | | | | | | | | | | | |
| 4 PLACES | ± | ± | | | | | | | | | | | | | | | | | | | | | |
| 3 PLACES | ± | ± 0.01 | | | | | | | | | | | | | | | | | | | | | |
| 2 PLACES | ± 0.25 | ± | | | | | | | | | | | | | | | | | | | | | |
| 1 PLACE | ± 0.38 | ± | | | | | | | | | | | | | | | | | | | | | |
| 0 PLACES | ± | ± | | | | | | | | | | | | | | | | | | | | | |
| ANGULAR TOL ± 0.5° | | DRAFT WHERE APPLICABLE MUST REMAIN WITHIN DIMENSIONS | THIRD ANGLE PROJECTION | DRAWING B-SIZE | SERIES 42375 | DOCUMENT NUMBER SD-42375-001 | DOC TYPE PSD | DOC PART 001 | REVISION V | | | | | | | | | | | | | | |

| ENG. NO: A-42375-4095/4129 | | | |
|----------------------------|-------------|--------------------|-------------|
| HEADER NUMBER: | | 42312-0036 | |
| PIN NUMBER: | | 42663-DEB228 | |
| PIN LENGTH: L | | .785 / 19.94 | |
| MATING LENGTH: M | | .470 / 11.94 | |
| GOLD POINT: G | | .250 / 6.35 | |
| PC TAIL LENGTH: P | | .225 / 5.72 | |
| TIN: T | | .200 / 5.08 | |
| CKTS: | | 2-36 | |
| KINKS: | | NO | |
| VOIDED CKTS: | | NONE | |
| PACKAGING: | | BULK PK-40873-0041 | |
| CKTS | ITEM NUMBER | CKTS | ITEM NUMBER |
| 2 | | 20 | |
| 3 | | 21 | |
| 4 | | 22 | |
| 5 | | 23 | |
| 6 | | 24 | |
| 7 | | 25 | |
| 8 | | 26 | |
| 9 | | 27 | |
| 10 | 42375-4103 | 28 | |
| 11 | | 29 | |
| 12 | | 30 | |
| 13 | | 31 | |
| 14 | | 32 | |
| 15 | | 33 | |
| 16 | | 34 | |
| 17 | | 35 | |
| 18 | 42375-4111 | 36 | |
| 19 | | | |

| ENG. NO: A-42375-4130/4161 | | | |
|----------------------------|-------------|--------------------|-------------|
| HEADER NUMBER: | | 42312-0036 | |
| PIN NUMBER: | | 42663-ATA154 | |
| PIN LENGTH: L | | 530/13.46 | |
| MATING LENGTH: M | | .320/8.13 | |
| GOLD POINT: G | | N/A | |
| PC TAIL LENGTH: P | | .120/3.05 | |
| TIN: T | | OVERALL | |
| CKTS: | | 5-36 | |
| KINKS: | | SMES-42003 | |
| VOIDED CKTS: | | 2, 3, 4 | |
| PACKAGING: | | BULK PK-40873-0041 | |
| CKTS | ITEM NUMBER | CKTS | ITEM NUMBER |
| | | 20 | |
| | | 21 | |
| | | 22 | |
| 5 | 42375-4130 | 23 | |
| 6 | | 24 | |
| 7 | | 25 | |
| 8 | | 26 | |
| 9 | | 27 | |
| 10 | | 28 | |
| 11 | | 29 | |
| 12 | | 30 | |
| 13 | | 31 | |
| 14 | | 32 | |
| 15 | | 33 | |
| 16 | | 34 | |
| 17 | | 35 | |
| 18 | | 36 | |
| 19 | | | |

| ENG. NO: 42375-4162/4196 | | | |
|--------------------------|-----------------|--------------------|-----------------|
| HEADER NUMBER: | | 42312-0036 | |
| PIN NUMBER: | | 42663-BSC228 | |
| PIN LENGTH: L | | .630/16.00 | |
| MATING LENGTH: M | | .400/10.16 | |
| GOLD POINT: G | | .345/8.76 | |
| PC TAIL LENGTH: P | | 140/3.56 | |
| TIN: T | | .100/2.54 | |
| CKTS: | | 2-36 | |
| KINKS: | | NO | |
| VOIDED CKTS: | | NONE | |
| PACKAGING: | | BULK PK-40873-0041 | |
| CKTS | MATERIAL NUMBER | CKTS | MATERIAL NUMBER |
| 2 | | 20 | |
| 3 | | 21 | |
| 4 | 42375-4164 | 22 | |
| 5 | 42375-4165 | 23 | |
| 6 | | 24 | |
| 7 | | 25 | |
| 8 | | 26 | |
| 9 | | 27 | |
| 10 | 42375-4170 | 28 | |
| 11 | | 29 | |
| 12 | | 30 | |
| 13 | | 31 | |
| 14 | | 32 | |
| 15 | | 33 | |
| 16 | | 34 | |
| 17 | | 35 | |
| 18 | | 36 | |
| 19 | | | |

| | | | | | | |
|---|---|--|--|--|---|---|
| SYMBOLS = 0 = 0 = 0 = 0 = 0 = 0 = 0 = 0 = 0 | THIS DRAWING CONTAINS INFORMATION THAT IS PROPRIETARY TO MOLEX ELECTRONIC TECHNOLOGIES, LLC AND SHOULD NOT BE USED WITHOUT WRITTEN PERMISSION | | CURRENT REV DESC: GOLD LENGTH SPEC CHANGED AS MIN 2.54- MAX 5.54 FOR A-42375-0037/0071 | | KK 100 HEADER ASSY FLAT VERTICAL BREAKAWAY PRODUCT CUSTOMER DRAWING | |
| | DIMENSION UNITS: MM/IN SCALE: 1:1 | | GENERAL TOLERANCES (UNLESS SPECIFIED) | | | EC NO: 689596 DRWN: SHRUTJ 2021/09/14 CHK'D: SHRUTJ 2021/12/20 APPR: ISHWARG 2021/12/20 |
| | 4 PLACES ± ± 3 PLACES ± ± 0.01 2 PLACES ± 0.25 ± 1 PLACE ± 0.38 ± 0 PLACES ± ± | | INITIAL REVISION: DRWN: SCHAFFER 2003/02/11 APPR: MARGULIS 2004/02/27 | | | |
| | ANGULAR TOL ± 0.5° | | DRAFT WHERE APPLICABLE MUST REMAIN WITHIN DIMENSIONS | | | DOCUMENT NUMBER: SD-42375-001 DOC TYPE: PSD DOC PART: 001 REVISION: V |
| | THIRD ANGLE PROJECTION | | DRAWING: B-SIZE SERIES: 42375 | | | |
| | MATERIAL NUMBER: SEE CHART | | CUSTOMER: GENERAL MARKET | | | SHEET NUMBER: 32 OF 35 |

| ENG. NO: A-42375-1622 | | | |
|-----------------------|--------------------|------|-----------------|
| HEADER NUMBER: | 42312-0036 | | |
| PIN NUMBER: | 42663-AYB208 | | |
| PIN LENGTH: L | .545 / 13.84 | | |
| MATING LENGTH: M | .320 / 8.13 | | |
| GOLD POINT: G | .140 / 3.56 | | |
| PC TAIL LENGTH: P | .135 / 3.43 | | |
| TIN: T | .135 / 3.43 | | |
| CKTS: | 2-36 | | |
| KINKS: | SMES-42003 | | |
| VOIDED CKTS: | 3 | | |
| PACKAGING: | BULK PK-40873-0041 | | |
| CKTS | MATERIAL NUMBER | CKTS | MATERIAL NUMBER |
| 2 | | 20 | |
| 3 | | 21 | |
| 4 | | 22 | |
| 5 | | 23 | |
| 6 | | 24 | |
| 7 | | 25 | |
| 8 | | 26 | |
| 9 | 42375-1622 | 27 | |
| 10 | | 28 | |
| 11 | | 29 | |
| 12 | | 30 | |
| 13 | | 31 | |
| 14 | | 32 | |
| 15 | | 33 | |
| 16 | | 34 | |
| 17 | | 35 | |
| 18 | | 36 | |
| 19 | | | |

| ENG. NO: A-42375-4199 | | | |
|-----------------------|--------------------|------|-----------------|
| HEADER NUMBER: | 42312-0036 | | |
| PIN NUMBER: | 42663-ARB228 | | |
| PIN LENGTH: L | .520 / 13.21 | | |
| MATING LENGTH: M | .230 / 5.84 | | |
| GOLD POINT: G | .140 / 3.56 | | |
| PC TAIL LENGTH: P | .200 / 5.08 | | |
| TIN: T | .135 / 3.43 | | |
| CKTS: | 2-36 | | |
| KINKS: | NO | | |
| VOIDED CKTS: | NONE | | |
| PACKAGING: | BULK PK-40873-0041 | | |
| CKTS | MATERIAL NUMBER | CKTS | MATERIAL NUMBER |
| 2 | 42375-4199 | 20 | |
| 3 | | 21 | |
| 4 | | 22 | |
| 5 | | 23 | |
| 6 | | 24 | |
| 7 | | 25 | |
| 8 | | 26 | |
| 9 | | 27 | |
| 10 | | 28 | |
| 11 | | 29 | |
| 12 | | 30 | |
| 13 | | 31 | |
| 14 | | 32 | |
| 15 | | 33 | |
| 16 | | 34 | |
| 17 | | 35 | |
| 18 | | 36 | |
| 19 | | | |

| ENG. NO: A-42375-4200 | | | |
|-----------------------|--------------------|------|-----------------|
| HEADER NUMBER: | 42312-0036 | | |
| PIN NUMBER: | 42663-ADB208 | | |
| PIN LENGTH: L | .465 / 11.81 | | |
| MATING LENGTH: M | .240 / 6.09 | | |
| GOLD POINT: G | .100 / 2.54 | | |
| PC TAIL LENGTH: P | .135 / 3.43 | | |
| TIN: T | .100 / 2.54 | | |
| CKTS: | 2-36 | | |
| KINKS: | SMES-42003 | | |
| VOIDED CKTS: | 3, 4 | | |
| PACKAGING: | BULK PK-40873-0041 | | |
| CKTS | MATERIAL NUMBER | CKTS | MATERIAL NUMBER |
| 2 | | 20 | |
| 3 | | 21 | |
| 4 | | 22 | |
| 5 | 42375-4200 | 23 | |
| 6 | | 24 | |
| 7 | | 25 | |
| 8 | | 26 | |
| 9 | | 27 | |
| 10 | | 28 | |
| 11 | | 29 | |
| 12 | | 30 | |
| 13 | | 31 | |
| 14 | | 32 | |
| 15 | | 33 | |
| 16 | | 34 | |
| 17 | | 35 | |
| 18 | | 36 | |
| 19 | | | |

| | | | | |
|-----------------|----|--------------|------------|----------|
| DOCUMENT STATUS | P1 | RELEASE DATE | 2021/12/20 | 12:18:33 |
|-----------------|----|--------------|------------|----------|

| SYMBOLS = 0 = 0 = 0 = 0 = 0 = 0 = 0 = 0 = 0 | THIS DRAWING CONTAINS INFORMATION THAT IS PROPRIETARY TO MOLEX ELECTRONIC TECHNOLOGIES, LLC AND SHOULD NOT BE USED WITHOUT WRITTEN PERMISSION | | CURRENT REV DESC: GOLD LENGTH SPEC CHANGED AS MIN 2.54- MAX 5.54 FOR A-42375-0037/0071 | | KK 100 HEADER ASSY FLAT VERTICAL BREAKAWAY PRODUCT CUSTOMER DRAWING | | | | | | | | | | | | | | | | | | |
|---|--|--------------------------|--|---|---|--|------|------------|--|--|------------|--|--------|------------|------|--|-----------|------|--|------------|--|--|---|
| | DIMENSION UNITS: MM/IN SCALE: 1:1 | | GENERAL TOLERANCES (UNLESS SPECIFIED) | | | EC NO: 689596 DRWN: SHRUTJ 2021/09/14 CHK'D: SHRUTJ 2021/12/20 APPR: ISHWARG 2021/12/20 | | | | | | | | | | | | | | | | | |
| | <table border="1"> <tr><th></th><th>MM</th><th>INCH</th></tr> <tr><td>4 PLACES ±</td><td></td><td></td></tr> <tr><td>3 PLACES ±</td><td></td><td>± 0.01</td></tr> <tr><td>2 PLACES ±</td><td>0.25</td><td></td></tr> <tr><td>1 PLACE ±</td><td>0.38</td><td></td></tr> <tr><td>0 PLACES ±</td><td></td><td></td></tr> </table> | | | MM | | | INCH | 4 PLACES ± | | | 3 PLACES ± | | ± 0.01 | 2 PLACES ± | 0.25 | | 1 PLACE ± | 0.38 | | 0 PLACES ± | | | INITIAL REVISION: DRWN: SCHAFFER 2003/02/11 APPR: MARGULIS 2004/02/27 |
| | | MM | INCH | | | | | | | | | | | | | | | | | | | | |
| | 4 PLACES ± | | | | | | | | | | | | | | | | | | | | | | |
| | 3 PLACES ± | | ± 0.01 | | | | | | | | | | | | | | | | | | | | |
| | 2 PLACES ± | 0.25 | | | | | | | | | | | | | | | | | | | | | |
| | 1 PLACE ± | 0.38 | | | | | | | | | | | | | | | | | | | | | |
| | 0 PLACES ± | | | | | | | | | | | | | | | | | | | | | | |
| | ANGULAR TOL ± 0.5° | | DRAFT WHERE APPLICABLE MUST REMAIN WITHIN DIMENSIONS | | | THIRD ANGLE PROJECTION | | | | | | | | | | | | | | | | | |
| DRAWING: B-SIZE | | SERIES: 42375 | | DOCUMENT NUMBER: SD-42375-001 DOC TYPE: PSD DOC PART: 001 REVISION: V | | | | | | | | | | | | | | | | | | | |
| MATERIAL NUMBER: SEE CHART | | CUSTOMER: GENERAL MARKET | | SHEET NUMBER: 33 OF 35 | | | | | | | | | | | | | | | | | | | |

| ENG. NO: 42375-4236 | | | |
|---------------------|-----------------|--------------------|-----------------|
| HEADER NUMBER: | | 42312-0036 | |
| PIN NUMBER: | | 42663-CCA118 | |
| PIN LENGTH: L | | .670 / 17.02 | |
| MATING LENGTH: M | | .440 / 11.18 | |
| GOLD POINT: G | | NA | |
| PC TAIL LENGTH: P | | .140 / 3.56 | |
| TIN: T | | OVERALL | |
| CKTS: | | 2-36 | |
| KINKS: | | SMES-42003 | |
| VOIDED CKTS: | | NONE | |
| PACKAGING: | | BULK PK-40873-0041 | |
| CKTS | MATERIAL NUMBER | CKTS | MATERIAL NUMBER |
| 2 | | 20 | |
| 3 | | 21 | |
| 4 | | 22 | |
| 5 | | 23 | |
| 6 | 42375-4236 | 24 | |
| 7 | | 25 | |
| 8 | | 26 | |
| 9 | | 27 | |
| 10 | | 28 | |
| 11 | | 29 | |
| 12 | | 30 | |
| 13 | | 31 | |
| 14 | | 32 | |
| 15 | | 33 | |
| 16 | | 34 | |
| 17 | | 35 | |
| 18 | | 36 | |
| 19 | | | |

| ENG. NO: 42375-4305 | | | |
|---------------------|-----------------|--------------------|-----------------|
| HEADER NUMBER: | | 42312-0036 | |
| PIN NUMBER: | | 42663-BDA154 | |
| PIN LENGTH: L | | .570 / 14.48 | |
| MATING LENGTH: M | | .339 / 8.61 | |
| GOLD POINT: G | | N/A | |
| PC TAIL LENGTH: P | | .140 / 3.56 | |
| TIN: T | | OVERALL | |
| CKTS: | | 2-36 | |
| KINKS: | | NO | |
| VOIDED CKTS: | | NONE | |
| PACKAGING: | | BULK PK-40873-0041 | |
| CKTS | MATERIAL NUMBER | CKTS | MATERIAL NUMBER |
| 2 | | 20 | |
| 3 | | 21 | |
| 4 | | 22 | |
| 5 | 42375-4305 | 23 | |
| 6 | | 24 | |
| 7 | | 25 | |
| 8 | | 26 | |
| 9 | | 27 | |
| 10 | | 28 | |
| 11 | | 29 | |
| 12 | | 30 | |
| 13 | | 31 | |
| 14 | | 32 | |
| 15 | | 33 | |
| 16 | | 34 | |
| 17 | | 35 | |
| 18 | | 36 | |
| 19 | | | |

| ENG. NO: 42375-4338/4341 | | | |
|--------------------------|-----------------|--------------------|-----------------|
| HEADER NUMBER: | | 42312-0036 | |
| PIN NUMBER: | | 42663-BGA154 | |
| PIN LENGTH: L | | .585 / 14.86 | |
| MATING LENGTH: M | | .398 / 10.11 | |
| GOLD POINT: G | | N/A | |
| PC TAIL LENGTH: P | | .097 / 2.46 | |
| TIN: T | | OVERALL | |
| CKTS: | | 2-36 | |
| KINKS: | | NO | |
| VOIDED CKTS: | | NONE | |
| PACKAGING: | | BULK PK-40873-0041 | |
| CKTS | MATERIAL NUMBER | CKTS | MATERIAL NUMBER |
| 2 | | 20 | |
| 3 | 42375-4338 | 21 | |
| 4 | | 22 | |
| 5 | | 23 | |
| 6 | 42375-4341 | 24 | |
| 7 | | 25 | |
| 8 | | 26 | |
| 9 | | 27 | |
| 10 | | 28 | |
| 11 | | 29 | |
| 12 | | 30 | |
| 13 | | 31 | |
| 14 | | 32 | |
| 15 | | 33 | |
| 16 | | 34 | |
| 17 | | 35 | |
| 18 | | 36 | |
| 19 | | | |

DOCUMENT STATUS P1 RELEASE DATE 2021/12/20 12:18:33

| SYMBOLS | THIS DRAWING CONTAINS INFORMATION THAT IS PROPRIETARY TO MOLEX ELECTRONIC TECHNOLOGIES, LLC AND SHOULD NOT BE USED WITHOUT WRITTEN PERMISSION | | | | | | | | | | | | | | | | | | | | | |
|--|---|---|--------------------------|---|---|-----------------|------------|----------------|----------|--------------|------------|-----|--------|------------|------|---|-----------|------|---|------------|--|---|
| | CURRENT REV DESC: GOLD LENGTH SPEC CHANGED AS MIN 2.54- MAX 5.54 FOR A-42375-0037/0071 | | | | KK 100 HEADER ASSY FLAT VERTICAL BREAKAWAY | | | | | | | | | | | | | | | | | |
| | GENERAL TOLERANCES (UNLESS SPECIFIED) | | PRODUCT CUSTOMER DRAWING | | | | | | | | | | | | | | | | | | | |
| | <table border="1"> <tr><th></th><th>MM</th><th>INCH</th></tr> <tr><td>4 PLACES ±</td><td></td><td></td></tr> <tr><td>3 PLACES ±</td><td></td><td>± 0.01</td></tr> <tr><td>2 PLACES ±</td><td>0.25</td><td>±</td></tr> <tr><td>1 PLACE ±</td><td>0.38</td><td>±</td></tr> <tr><td>0 PLACES ±</td><td></td><td>±</td></tr> </table> | | | | | MM | INCH | 4 PLACES ± | | | 3 PLACES ± | | ± 0.01 | 2 PLACES ± | 0.25 | ± | 1 PLACE ± | 0.38 | ± | 0 PLACES ± | | ± |
| | | MM | INCH | | | | | | | | | | | | | | | | | | | |
| | 4 PLACES ± | | | | | | | | | | | | | | | | | | | | | |
| | 3 PLACES ± | | ± 0.01 | | | | | | | | | | | | | | | | | | | |
| | 2 PLACES ± | 0.25 | ± | | | | | | | | | | | | | | | | | | | |
| | 1 PLACE ± | 0.38 | ± | | | | | | | | | | | | | | | | | | | |
| | 0 PLACES ± | | ± | | | | | | | | | | | | | | | | | | | |
| ANGULAR TOL ± 0.5° | | INITIAL REVISION: DRWN: SCHAFFER 2003/02/11 APPR: MARGULIS 2004/02/27 | | | | | | | | | | | | | | | | | | | | |
| DRAFT WHERE APPLICABLE MUST REMAIN WITHIN DIMENSIONS | | | | <table border="1"> <tr> <th>DOCUMENT NUMBER</th> <th>DOC TYPE</th> <th>DOC PART</th> <th>REVISION</th> </tr> <tr> <td>SD-42375-001</td> <td>PSD</td> <td>001</td> <td>V</td> </tr> </table> | | DOCUMENT NUMBER | DOC TYPE | DOC PART | REVISION | SD-42375-001 | PSD | 001 | V | | | | | | | | | |
| DOCUMENT NUMBER | DOC TYPE | DOC PART | REVISION | | | | | | | | | | | | | | | | | | | |
| SD-42375-001 | PSD | 001 | V | | | | | | | | | | | | | | | | | | | |
| THIRD ANGLE PROJECTION | | <table border="1"> <tr> <th>MATERIAL NUMBER</th> <th>CUSTOMER</th> <th>SHEET NUMBER</th> </tr> <tr> <td>SEE CHART</td> <td>GENERAL MARKET</td> <td>34 OF 35</td> </tr> </table> | | MATERIAL NUMBER | CUSTOMER | SHEET NUMBER | SEE CHART | GENERAL MARKET | 34 OF 35 | | | | | | | | | | | | | |
| MATERIAL NUMBER | CUSTOMER | | | SHEET NUMBER | | | | | | | | | | | | | | | | | | |
| SEE CHART | GENERAL MARKET | 34 OF 35 | | | | | | | | | | | | | | | | | | | | |
| DRAWING | | <table border="1"> <tr> <th>SERIES</th> <th>SHEET NUMBER</th> </tr> <tr> <td>B-SIZE</td> <td>42375</td> </tr> </table> | | SERIES | SHEET NUMBER | B-SIZE | 42375 | | | | | | | | | | | | | | | |
| SERIES | SHEET NUMBER | | | | | | | | | | | | | | | | | | | | | |
| B-SIZE | 42375 | | | | | | | | | | | | | | | | | | | | | |
| SCALE | | <table border="1"> <tr> <th>DIMENSION UNITS</th> <th>SCALE</th> </tr> <tr> <td>MM/IN</td> <td>1:1</td> </tr> </table> | | DIMENSION UNITS | SCALE | MM/IN | 1:1 | | | | | | | | | | | | | | | |
| DIMENSION UNITS | SCALE | | | | | | | | | | | | | | | | | | | | | |
| MM/IN | 1:1 | | | | | | | | | | | | | | | | | | | | | |
| DIMENSION UNITS | | <table border="1"> <tr> <th>REVISION</th> <th>DATE</th> </tr> <tr> <td>9</td> <td>2018/01/18</td> </tr> </table> | | REVISION | DATE | 9 | 2018/01/18 | | | | | | | | | | | | | | | |
| REVISION | DATE | | | | | | | | | | | | | | | | | | | | | |
| 9 | 2018/01/18 | | | | | | | | | | | | | | | | | | | | | |
| SCALE | | | | | | | | | | | | | | | | | | | | | | |

| ENG. NO: 42375-4413 | | | |
|---------------------|-----------------|--------------------|-----------------|
| HEADER NUMBER: | | 42312-0036 | |
| PIN NUMBER: | | 42663-ABB208 | |
| PIN LENGTH: L | | .455 / 11.56 | |
| MATING LENGTH: M | | .240 / 6.09 | |
| GOLD POINT: G | | .100 / 2.54 | |
| PC TAIL LENGTH: P | | .125 / 3.18 | |
| TIN: T | | .100 / 2.54 | |
| CKTS: | | 6-36 | |
| KINKS: | | NO | |
| VOIDED CKTS: | | 2, 4, 6 | |
| PACKAGING: | | BULK PK-40873-0041 | |
| CKTS | MATERIAL NUMBER | CKTS | MATERIAL NUMBER |
| 2 | | 20 | |
| 3 | | 21 | |
| 4 | | 22 | |
| 5 | | 23 | |
| 6 | | 24 | |
| 7 | 42375-4413 | 25 | |
| 8 | | 26 | |
| 9 | | 27 | |
| 10 | | 28 | |
| 11 | | 29 | |
| 12 | | 30 | |
| 13 | | 31 | |
| 14 | | 32 | |
| 15 | | 33 | |
| 16 | | 34 | |
| 17 | | 35 | |
| 18 | | 36 | |
| 19 | | | |

| ENG. NO: 42375-4445 | | | |
|---------------------|-----------------|--------------------|-----------------|
| HEADER NUMBER: | | 42312-0036 | |
| PIN NUMBER: | | 42663-0364 | |
| PLATING: | | 228 | |
| PIN LENGTH: L | | .590 / 14.99 | |
| MATING LENGTH: M | | .380 / 9.65 | |
| GOLD POINT: G | | .200 / 5.08 | |
| PC TAIL LENGTH: P | | .120 / 3.05 | |
| TIN: T | | .135 / 3.43 | |
| CKTS: | | 2-36 | |
| KINKS: | | NO | |
| VOIDED CKTS: | | NONE | |
| PACKAGING: | | BULK PK-40873-0041 | |
| CKTS | MATERIAL NUMBER | CKTS | MATERIAL NUMBER |
| 2 | | 20 | |
| 3 | | 21 | |
| 4 | 42375-4445 | 22 | |
| 5 | | 23 | |
| 6 | | 24 | |
| 7 | | 25 | |
| 8 | | 26 | |
| 9 | | 27 | |
| 10 | | 28 | |
| 11 | | 29 | |
| 12 | | 30 | |
| 13 | | 31 | |
| 14 | | 32 | |
| 15 | | 33 | |
| 16 | | 34 | |
| 17 | | 35 | |
| 18 | | 36 | |
| 19 | | | |

| ENG. NO: 42375-4549 | | | |
|---------------------|-----------------|---------------------------------------|-----------------|
| HEADER NUMBER: | | 42312-0036 | |
| PIN NUMBER: | | 42663-ABB208 | |
| PLATING: | | 208 | |
| PIN LENGTH: L | | .455 / 11.56 | |
| MATING LENGTH: M | | .240 / 6.09 | |
| GOLD POINT: G | | .100 / 2.54 | |
| PC TAIL LENGTH: P | | .125 / 3.18 | |
| TIN: T | | .100 / 2.54 | |
| CKTS: | | 2-36 | |
| KINKS: | | NO | |
| VOIDED CKTS: | | NONE | |
| PACKAGING: | | TAPE AND REEL W/O CAP 423751000-PK | |
| CKTS | MATERIAL NUMBER | CKTS | MATERIAL NUMBER |
| 2 | 22-28-4029 | 20 | |
| 3 | | 21 | |
| 4 | | 22 | |
| 5 | | 23 | |
| 6 | | 24 | |
| 7 | | 25 | |
| 8 | | 26 | |
| 9 | | 27 | |
| 10 | | 28 | |
| 11 | | 29 | |
| 12 | | 30 | |
| 13 | | 31 | |
| 14 | | 32 | |
| 15 | | 33 | |
| 16 | | 34 | |
| 17 | | 35 | |
| 18 | | 36 | |
| 19 | | | |

| | | | | |
|--|---|--|---|---|
| SYMBOLS = 0 = 0 = 0 = 0 = 0 = 0 = 0 = 0 | THIS DRAWING CONTAINS INFORMATION THAT IS PROPRIETARY TO MOLEX ELECTRONIC TECHNOLOGIES, LLC AND SHOULD NOT BE USED WITHOUT WRITTEN PERMISSION DIMENSION UNITS: MM/IN SCALE: 1:1 | CURRENT REV DESC: GOLD LENGTH SPEC CHANGED AS MIN 2.54- MAX 5.54 FOR A-42375-0037/0071 EC NO: 689596 DRWN: SHRUTJ 2021/09/14 CHK'D: SHRUTJ 2021/12/20 APPR: ISHWARG 2021/12/20 | KK 100 HEADER ASSY FLAT VERTICAL BREAKAWAY PRODUCT CUSTOMER DRAWING | |
| | GENERAL TOLERANCES (UNLESS SPECIFIED) | INITIAL REVISION: DRWN: SCHAFFER 2003/02/11 APPR: MARGULIS 2004/02/27 | | DOCUMENT NUMBER: SD-42375-001 DOC TYPE: PSD DOC PART: 001 REVISION: V |
| | 4 PLACES ± 3 PLACES ± 0.25 2 PLACES ± 0.38 1 PLACE ± 0 PLACES ± | ANGULAR TOL ± 0.5° | | MATERIAL NUMBER: SEE CHART CUSTOMER: GENERAL MARKET SHEET NUMBER: 35 OF 35 |
| | DRAFT WHERE APPLICABLE MUST REMAIN WITHIN DIMENSIONS | THIRD ANGLE PROJECTION | | DRAWING: B-SIZE SERIES: 42375 |

ENG. NO: A-42375-0002/0036

| | |
|-------------------|--------------------|
| HEADER NUMBER: | 42312-0036 |
| PIN NUMBER: | 42663-ABA154 |
| PIN LENGTH: L | .455 / 11.56 |
| MATING LENGTH: M | .240 / 6.09 |
| GOLD POINT: G | N/A |
| PC TAIL LENGTH: P | .125 / 3.18 |
| TIN: T | OVERALL |
| CKTS: | 2-36 |
| KINKS: | NO |
| VOIDED CKTS: | NONE |
| PACKAGING: | BULK PK-40873-0041 |

| CKTS | MATERIAL NUMBER | ENG NUMBER | CKTS | MATERIAL NUMBER | ENG NUMBER |
|------|-----------------|--------------|------|-----------------|--------------|
| 02 | 22-28-4020 | A-42375-0002 | 20 | 22-28-4200 | A-42375-0020 |
| 03 | 22-28-4030 | A-42375-0003 | 21 | 22-28-4210 | A-42375-0021 |
| 04 | 22-28-4040 | A-42375-0004 | 22 | 22-28-4220 | A-42375-0022 |
| 05 | 22-28-4050 | A-42375-0005 | 23 | 22-28-4230 | A-42375-0023 |
| 06 | 22-28-4060 | A-42375-0006 | 24 | 22-28-4240 | A-42375-0024 |
| 07 | 22-28-4070 | A-42375-0007 | 25 | 22-28-4250 | A-42375-0025 |
| 08 | 22-28-4080 | A-42375-0008 | 26 | 22-28-4260 | A-42375-0026 |
| 09 | 22-28-4090 | A-42375-0009 | 27 | 22-28-4270 | A-42375-0027 |
| 10 | 22-28-4100 | A-42375-0010 | 28 | 22-28-4280 | A-42375-0028 |
| 11 | 22-28-4110 | A-42375-0011 | 29 | 22-28-4290 | A-42375-0029 |
| 12 | 22-28-4120 | A-42375-0012 | 30 | 22-28-4300 | A-42375-0030 |
| 13 | 22-28-4130 | A-42375-0013 | 31 | 22-28-4310 | A-42375-0031 |
| 14 | 22-28-4140 | A-42375-0014 | 32 | 22-28-4320 | A-42375-0032 |
| 15 | 22-28-4150 | A-42375-0015 | 33 | 22-28-4330 | A-42375-0033 |
| 16 | 22-28-4160 | A-42375-0016 | 34 | 22-28-4340 | A-42375-0034 |
| 17 | 22-28-4170 | A-42375-0017 | 35 | 22-28-4350 | A-42375-0035 |
| 18 | 22-28-4180 | A-42375-0018 | 36 | 22-28-4360 | A-42375-0036 |
| 19 | 22-28-4190 | A-42375-0019 | | | |

ENG. NO: A-42375-0037/0071

| | |
|-------------------|--------------------------------|
| HEADER NUMBER: | 42312-0036 |
| PIN NUMBER: | 42663-ABB208 |
| PIN LENGTH: L | .455 / 11.56 |
| MATING LENGTH: M | .240 / 6.09 |
| GOLD POINT: G | .100 / 2.54 Min-0.218/5.54 Max |
| PC TAIL LENGTH: P | .125 / 3.18 |
| TIN: T | .100 / 2.54 |
| CKTS: | 2-36 |
| KINKS: | NO |
| VOIDED CKTS: | NONE |
| PACKAGING: | BULK PK-40873-0041 |

| CKTS | MATERIAL NUMBER | ENG NUMBER | CKTS | MATERIAL NUMBER | ENG NUMBER |
|------|-----------------|--------------|------|-----------------|--------------|
| 02 | 22-28-4023 | A-42375-0037 | 20 | 22-28-4203 | A-42375-0055 |
| 03 | 22-28-4033 | A-42375-0038 | 21 | 22-28-4213 | A-42375-0056 |
| 04 | 22-28-4043 | A-42375-0039 | 22 | 22-28-4223 | A-42375-0057 |
| 05 | 22-28-4053 | A-42375-0040 | 23 | 22-28-4233 | A-42375-0058 |
| 06 | 22-28-4063 | A-42375-0041 | 24 | 22-28-4243 | A-42375-0059 |
| 07 | 22-28-4073 | A-42375-0042 | 25 | 22-28-4253 | A-42375-0060 |
| 08 | 22-28-4083 | A-42375-0043 | 26 | 22-28-4263 | A-42375-0061 |
| 09 | 22-28-4093 | A-42375-0044 | 27 | 22-28-4273 | A-42375-0062 |
| 10 | 22-28-4103 | A-42375-0045 | 28 | 22-28-4283 | A-42375-0063 |
| 11 | 22-28-4113 | A-42375-0046 | 29 | 22-28-4293 | A-42375-0064 |
| 12 | 22-28-4123 | A-42375-0047 | 30 | 22-28-4303 | A-42375-0065 |
| 13 | 22-28-4133 | A-42375-0048 | 31 | 22-28-4313 | A-42375-0066 |
| 14 | 22-28-4143 | A-42375-0049 | 32 | 22-28-4323 | A-42375-0067 |
| 15 | 22-28-4153 | A-42375-0050 | 33 | 22-28-4333 | A-42375-0068 |
| 16 | 22-28-4163 | A-42375-0051 | 34 | 22-28-4343 | A-42375-0069 |
| 17 | 22-28-4173 | A-42375-0052 | 35 | 22-28-4353 | A-42375-0070 |
| 18 | 22-28-4183 | A-42375-0053 | 36 | 22-28-4363 | A-42375-0071 |
| 19 | 22-28-4193 | A-42375-0054 | | | |

| | | | |
|--|--|---|--------------------------------|
| REV: U | ECR/ECN INFORMATION: | TITLE: KK 100 HEADER ASSY FLAT VERTICAL BREAKAWAY | SHEET No. - 2 - |
| | EC No.: UCP2017-2793 DATE: 12/20/2021 | | |
| DOCUMENT NUMBER: SD- 42375-001 | CREATED / REVISED BY: SS06 | CHECKED BY: ISHWARG | APPROVED BY: ISHWARG |

ENG. NO: A-42375-0072/0106

| | |
|-------------------|--------------------|
| HEADER NUMBER: | 42312-0036 |
| PIN NUMBER: | 42663-ABB228 |
| PIN LENGTH: L | .455 / 11.56 |
| MATING LENGTH: M | .240 / 6.09 |
| GOLD POINT: G | .100 / 2.54 |
| PC TAIL LENGTH: P | .125 / 3.18 |
| TIN: T | .100 / 2.54 |
| CKTS: | 2-36 |
| KINKS: | NO |
| VOIDED CKTS: | NONE |
| PACKAGING: | BULK PK-40873-0041 |

| CKTS | MATERIAL NUMBER | ENG NUMBER | CKTS | MATERIAL NUMBER | ENG NUMBER |
|------|-----------------|--------------|------|-----------------|--------------|
| 02 | 22-28-4026 | A-42375-0072 | 20 | 22-28-4206 | A-42375-0090 |
| 03 | 22-28-4036 | A-42375-0073 | 21 | 22-28-4216 | A-42375-0091 |
| 04 | 22-28-4046 | A-42375-0074 | 22 | 22-28-4226 | A-42375-0092 |
| 05 | 22-28-4056 | A-42375-0075 | 23 | 22-28-4236 | A-42375-0093 |
| 06 | 22-28-4066 | A-42375-0076 | 24 | 22-28-4246 | A-42375-0094 |
| 07 | 22-28-4076 | A-42375-0077 | 25 | 22-28-4256 | A-42375-0095 |
| 08 | 22-28-4086 | A-42375-0078 | 26 | 22-28-4266 | A-42375-0096 |
| 09 | 22-28-4096 | A-42375-0079 | 27 | 22-28-4276 | A-42375-0097 |
| 10 | 22-28-4106 | A-42375-0080 | 28 | 22-28-4286 | A-42375-0098 |
| 11 | 22-28-4116 | A-42375-0081 | 29 | 22-28-4296 | A-42375-0099 |
| 12 | 22-28-4126 | A-42375-0082 | 30 | 22-28-4306 | A-42375-0100 |
| 13 | 22-28-4136 | A-42375-0083 | 31 | 22-28-4316 | A-42375-0101 |
| 14 | 22-28-4146 | A-42375-0084 | 32 | 22-28-4326 | A-42375-0102 |
| 15 | 22-28-4156 | A-42375-0085 | 33 | 22-28-4336 | A-42375-0103 |
| 16 | 22-28-4166 | A-42375-0086 | 34 | 22-28-4346 | A-42375-0104 |
| 17 | 22-28-4176 | A-42375-0087 | 35 | 22-28-4356 | A-42375-0105 |
| 18 | 22-28-4186 | A-42375-0088 | 36 | 22-28-4366 | A-42375-0106 |
| 19 | 22-28-4196 | A-42375-0089 | | | |

ENG. NO: A-42375-0107/0141

| | |
|-------------------|--------------------|
| HEADER NUMBER: | 42312-0036 |
| PIN NUMBER: | 42663-ATA154 |
| PIN LENGTH: L | .530 / 13.46 |
| MATING LENGTH: M | .320 / 8.13 |
| GOLD POINT: G | N/A |
| PC TAIL LENGTH: P | .120 / 3.05 |
| TIN: T | OVERALL |
| CKTS: | 2-36 |
| KINKS: | NO |
| VOIDED CKTS: | NONE |
| PACKAGING: | BULK PK-40873-0041 |

| CKTS | MATERIAL NUMBER | ENG NUMBER | CKTS | MATERIAL NUMBER | ENG NUMBER |
|------|-----------------|--------------|------|-----------------|--------------|
| 02 | 22-28-4021 | A-42375-0107 | 20 | 22-28-4201 | A-42375-0125 |
| 03 | 22-28-4031 | A-42375-0108 | 21 | 22-28-4211 | A-42375-0126 |
| 04 | 22-28-4041 | A-42375-0109 | 22 | 22-28-4221 | A-42375-0127 |
| 05 | 22-28-4051 | A-42375-0110 | 23 | 22-28-4231 | A-42375-0128 |
| 06 | 22-28-4061 | A-42375-0111 | 24 | 22-28-4241 | A-42375-0129 |
| 07 | 22-28-4071 | A-42375-0112 | 25 | 22-28-4251 | A-42375-0130 |
| 08 | 22-28-4081 | A-42375-0113 | 26 | 22-28-4261 | A-42375-0131 |
| 09 | 22-28-4091 | A-42375-0114 | 27 | 22-28-4271 | A-42375-0132 |
| 10 | 22-28-4101 | A-42375-0115 | 28 | 22-28-4281 | A-42375-0133 |
| 11 | 22-28-4111 | A-42375-0116 | 29 | 22-28-4291 | A-42375-0134 |
| 12 | 22-28-4121 | A-42375-0117 | 30 | 22-28-4301 | A-42375-0135 |
| 13 | 22-28-4131 | A-42375-0118 | 31 | 22-28-4311 | A-42375-0136 |
| 14 | 22-28-4141 | A-42375-0119 | 32 | 22-28-4321 | A-42375-0137 |
| 15 | 22-28-4151 | A-42375-0120 | 33 | 22-28-4331 | A-42375-0138 |
| 16 | 22-28-4161 | A-42375-0121 | 34 | 22-28-4341 | A-42375-0139 |
| 17 | 22-28-4171 | A-42375-0122 | 35 | 22-28-4351 | A-42375-0140 |
| 18 | 22-28-4181 | A-42375-0123 | 36 | 22-28-4361 | A-42375-0141 |
| 19 | 22-28-4191 | A-42375-0124 | | | |

| | | | |
|--|--|---|-------------------------------|
| REV: U | ECR/ECN INFORMATION: EC No.: UCP2017-2793 DATE: 12/20/2021 | TITLE: KK 100 HEADER ASSY FLAT VERTICAL BREAKAWAY | SHEET No. - 3 - |
| DOCUMENT NUMBER: SD- 42375-001 | | CREATED / REVISED BY: SS06 | CHECKED BY: ISHWARG |
| | | APPROVED BY: ISHWARG | |

ENG. NO: A-42375-0142/0176

| | |
|-------------------|--------------------|
| HEADER NUMBER: | 42312-0036 |
| PIN NUMBER: | 42663-ATB208 |
| PIN LENGTH: L | .530 / 13.46 |
| MATING LENGTH: M | .320 / 8.13 |
| GOLD POINT: G | .140 / 3.56 |
| PC TAIL LENGTH: P | .120 / 3.05 |
| TIN: T | .135 / 3.43 |
| CKTS: | 2-36 |
| KINKS: | NO |
| VOIDED CKTS: | NONE |
| PACKAGING: | BULK PK-40873-0041 |

| CKTS | MATERIAL NUMBER | ENG NUMBER | CKTS | MATERIAL NUMBER | ENG NUMBER |
|------|-----------------|--------------|------|-----------------|--------------|
| 02 | 22-28-4024 | A-42375-0142 | 20 | 22-28-4204 | A-42375-0160 |
| 03 | 22-28-4034 | A-42375-0143 | 21 | 22-28-4214 | A-42375-0161 |
| 04 | 22-28-4044 | A-42375-0144 | 22 | 22-28-4224 | A-42375-0162 |
| 05 | 22-28-4054 | A-42375-0145 | 23 | 22-28-4234 | A-42375-0163 |
| 06 | 22-28-4064 | A-42375-0146 | 24 | 22-28-4244 | A-42375-0164 |
| 07 | 22-28-4074 | A-42375-0147 | 25 | 22-28-4254 | A-42375-0165 |
| 08 | 22-28-4084 | A-42375-0148 | 26 | 22-28-4264 | A-42375-0166 |
| 09 | 22-28-4094 | A-42375-0149 | 27 | 22-28-4274 | A-42375-0167 |
| 10 | 22-28-4104 | A-42375-0150 | 28 | 22-28-4284 | A-42375-0168 |
| 11 | 22-28-4114 | A-42375-0151 | 29 | 22-28-4294 | A-42375-0169 |
| 12 | 22-28-4124 | A-42375-0152 | 30 | 22-28-4304 | A-42375-0170 |
| 13 | 22-28-4134 | A-42375-0153 | 31 | 22-28-4314 | A-42375-0171 |
| 14 | 22-28-4144 | A-42375-0154 | 32 | 22-28-4324 | A-42375-0172 |
| 15 | 22-28-4154 | A-42375-0155 | 33 | 22-28-4334 | A-42375-0173 |
| 16 | 22-28-4164 | A-42375-0156 | 34 | 22-28-4344 | A-42375-0174 |
| 17 | 22-28-4174 | A-42375-0157 | 35 | 22-28-4354 | A-42375-0175 |
| 18 | 22-28-4184 | A-42375-0158 | 36 | 22-28-4364 | A-42375-0176 |
| 19 | 22-28-4194 | A-42375-0159 | | | |

ENG. NO: A-42375-0177/0211

| | |
|-------------------|--------------------|
| HEADER NUMBER: | 42312-0036 |
| PIN NUMBER: | 42663-ATB228 |
| PIN LENGTH: L | .530 / 13.46 |
| MATING LENGTH: M | .320 / 8.13 |
| GOLD POINT: G | .140 / 3.56 |
| PC TAIL LENGTH: P | .120 / 3.05 |
| TIN: T | .135 / 3.43 |
| CKTS: | 2-36 |
| KINKS: | NO |
| VOIDED CKTS: | NONE |
| PACKAGING: | BULK PK-40873-0041 |

| CKTS | MATERIAL NUMBER | ENG NUMBER | CKTS | MATERIAL NUMBER | ENG NUMBER |
|------|-----------------|--------------|------|-----------------|--------------|
| 02 | 22-28-4027 | A-42375-0177 | 20 | 22-28-4207 | A-42375-0195 |
| 03 | 22-28-4037 | A-42375-0178 | 21 | 22-28-4217 | A-42375-0196 |
| 04 | 22-28-4047 | A-42375-0179 | 22 | 22-28-4227 | A-42375-0197 |
| 05 | 22-28-4057 | A-42375-0180 | 23 | 22-28-4237 | A-42375-0198 |
| 06 | 22-28-4067 | A-42375-0181 | 24 | 22-28-4247 | A-42375-0199 |
| 07 | 22-28-4077 | A-42375-0182 | 25 | 22-28-4257 | A-42375-0200 |
| 08 | 22-28-4087 | A-42375-0183 | 26 | 22-28-4267 | A-42375-0201 |
| 09 | 22-28-4097 | A-42375-0184 | 27 | 22-28-4277 | A-42375-0202 |
| 10 | 22-28-4107 | A-42375-0185 | 28 | 22-28-4287 | A-42375-0203 |
| 11 | 22-28-4117 | A-42375-0186 | 29 | 22-28-4297 | A-42375-0204 |
| 12 | 22-28-4127 | A-42375-0187 | 30 | 22-28-4307 | A-42375-0205 |
| 13 | 22-28-4137 | A-42375-0188 | 31 | 22-28-4317 | A-42375-0206 |
| 14 | 22-28-4147 | A-42375-0189 | 32 | 22-28-4327 | A-42375-0207 |
| 15 | 22-28-4157 | A-42375-0190 | 33 | 22-28-4337 | A-42375-0208 |
| 16 | 22-28-4167 | A-42375-0191 | 34 | 22-28-4347 | A-42375-0209 |
| 17 | 22-28-4177 | A-42375-0192 | 35 | 22-28-4357 | A-42375-0210 |
| 18 | 22-28-4187 | A-42375-0193 | 36 | 22-28-4367 | A-42375-0211 |
| 19 | 22-28-4197 | A-42375-0194 | | | |

REV:

UECR/ECN INFORMATION:EC No.: **UCP2017-2793**DATE: **12/20/2021**TITLE:

**KK 100 HEADER ASSY
FLAT VERTICAL
BREAKAWAY**

SHEET No.**- 4 -**DOCUMENT NUMBER:**SD- 42375-001**CREATED / REVISED BY:**SS06**CHECKED BY:**ISHWARG**APPROVED BY:**ISHWARG**

ENG. NO: A-42375-0212/0246

| | |
|-------------------|--------------------|
| HEADER NUMBER: | 42312-0036 |
| PIN NUMBER: | 42663-AMA154 |
| PIN LENGTH: L | .505 / 12.83 |
| MATING LENGTH: M | .295 / 7.49 |
| GOLD POINT: G | N/A |
| PC TAIL LENGTH: P | .120 / 3.05 |
| TIN: T | OVERALL |
| CKTS: | 2-36 |
| KINKS: | NO |
| VOIDED CKTS: | NONE |
| PACKAGING: | BULK PK-40873-0041 |

| CKTS | MATERIAL NUMBER | ENG NUMBER | CKTS | MATERIAL NUMBER | ENG NUMBER |
|------|-----------------|--------------|------|-----------------|--------------|
| 02 | 22-28-4022 | A-42375-0212 | 20 | 22-28-4202 | A-42375-0230 |
| 03 | 22-28-4032 | A-42375-0213 | 21 | 22-28-4212 | A-42375-0231 |
| 04 | 22-28-4042 | A-42375-0214 | 22 | 22-28-4222 | A-42375-0232 |
| 05 | 22-28-4052 | A-42375-0215 | 23 | 22-28-4232 | A-42375-0233 |
| 06 | 22-28-4062 | A-42375-0216 | 24 | 22-28-4242 | A-42375-0234 |
| 07 | 22-28-4072 | A-42375-0217 | 25 | 22-28-4252 | A-42375-0235 |
| 08 | 22-28-4082 | A-42375-0218 | 26 | 22-28-4262 | A-42375-0236 |
| 09 | 22-28-4092 | A-42375-0219 | 27 | 22-28-4272 | A-42375-0237 |
| 10 | 22-28-4102 | A-42375-0220 | 28 | 22-28-4282 | A-42375-0238 |
| 11 | 22-28-4112 | A-42375-0221 | 29 | 22-28-4292 | A-42375-0239 |
| 12 | 22-28-4122 | A-42375-0222 | 30 | 22-28-4302 | A-42375-0240 |
| 13 | 22-28-4132 | A-42375-0223 | 31 | 22-28-4312 | A-42375-0241 |
| 14 | 22-28-4142 | A-42375-0224 | 32 | 22-28-4322 | A-42375-0242 |
| 15 | 22-28-4152 | A-42375-0225 | 33 | 22-28-4332 | A-42375-0243 |
| 16 | 22-28-4162 | A-42375-0226 | 34 | 22-28-4342 | A-42375-0244 |
| 17 | 22-28-4172 | A-42375-0227 | 35 | 22-28-4352 | A-42375-0245 |
| 18 | 22-28-4182 | A-42375-0228 | 36 | 22-28-4362 | A-42375-0246 |
| 19 | 22-28-4192 | A-42375-0229 | | | |

ENG. NO: A-42375-0247/0281

| | |
|-------------------|--------------------|
| HEADER NUMBER: | 42312-0036 |
| PIN NUMBER: | 42663-AMB208 |
| PIN LENGTH: L | .505 / 12.83 |
| MATING LENGTH: M | .295 / 7.49 |
| GOLD POINT: G | .140 / 3.56 |
| PC TAIL LENGTH: P | .120 / 3.05 |
| TIN: T | .135 / 3.43 |
| CKTS: | 2-36 |
| KINKS: | NO |
| VOIDED CKTS: | NONE |
| PACKAGING: | BULK PK-40873-0041 |

| CKTS | MATERIAL NUMBER | ENG NUMBER | CKTS | MATERIAL NUMBER | ENG NUMBER |
|------|-----------------|--------------|------|-----------------|--------------|
| 02 | 22-28-4025 | A-42375-0247 | 20 | 22-28-4205 | A-42375-0265 |
| 03 | 22-28-4035 | A-42375-0248 | 21 | 22-28-4215 | A-42375-0266 |
| 04 | 22-28-4045 | A-42375-0249 | 22 | 22-28-4225 | A-42375-0267 |
| 05 | 22-28-4055 | A-42375-0250 | 23 | 22-28-4235 | A-42375-0268 |
| 06 | 22-28-4065 | A-42375-0251 | 24 | 22-28-4245 | A-42375-0269 |
| 07 | 22-28-4075 | A-42375-0252 | 25 | 22-28-4255 | A-42375-0270 |
| 08 | 22-28-4085 | A-42375-0253 | 26 | 22-28-4265 | A-42375-0271 |
| 09 | 22-28-4095 | A-42375-0254 | 27 | 22-28-4275 | A-42375-0272 |
| 10 | 22-28-4105 | A-42375-0255 | 28 | 22-28-4285 | A-42375-0273 |
| 11 | 22-28-4115 | A-42375-0256 | 29 | 22-28-4295 | A-42375-0274 |
| 12 | 22-28-4125 | A-42375-0257 | 30 | 22-28-4305 | A-42375-0275 |
| 13 | 22-28-4135 | A-42375-0258 | 31 | 22-28-4315 | A-42375-0276 |
| 14 | 22-28-4145 | A-42375-0259 | 32 | 22-28-4325 | A-42375-0277 |
| 15 | 22-28-4155 | A-42375-0260 | 33 | 22-28-4335 | A-42375-0278 |
| 16 | 22-28-4165 | A-42375-0261 | 34 | 22-28-4345 | A-42375-0279 |
| 17 | 22-28-4175 | A-42375-0262 | 35 | 22-28-4355 | A-42375-0280 |
| 18 | 22-28-4185 | A-42375-0263 | 36 | 22-28-4365 | A-42375-0281 |
| 19 | 22-28-4195 | A-42375-0264 | | | |

| | | | |
|--|--|---|-------------------------------|
| REV: U | ECR/ECN INFORMATION: EC No.: UCP2017-2793 DATE: 12/20/2021 | TITLE: KK 100 HEADER ASSY FLAT VERTICAL BREAKAWAY | SHEET No. - 5 - |
| DOCUMENT NUMBER: SD- 42375-001 | | CREATED / REVISED BY: SS06 | CHECKED BY: ISHWARG |
| | | APPROVED BY: ISHWARG | |

ENG. NO: A-42375-0282/0316

| | |
|-------------------|--------------------|
| HEADER NUMBER: | 42312-0036 |
| PIN NUMBER: | 42663-AMB228 |
| PIN LENGTH: L | .505 / 12.83 |
| MATING LENGTH: M | .295 / 7.49 |
| GOLD POINT: G | .140 / 3.56 |
| PC TAIL LENGTH: P | .120 / 3.05 |
| TIN: T | .135 / 3.43 |
| CKTS: | 2-36 |
| KINKS: | NO |
| VOIDED CKTS: | NONE |
| PACKAGING: | BULK PK-40873-0041 |

| CKTS | MATERIAL NUMBER | ENG NUMBER | CKTS | MATERIAL NUMBER | ENG NUMBER |
|------|-----------------|--------------|------|-----------------|--------------|
| 02 | 22-28-4028 | A-42375-0282 | 20 | 22-28-4208 | A-42375-0300 |
| 03 | 22-28-4038 | A-42375-0283 | 21 | 22-28-4218 | A-42375-0301 |
| 04 | 22-28-4048 | A-42375-0284 | 22 | 22-28-4228 | A-42375-0302 |
| 05 | 22-28-4058 | A-42375-0285 | 23 | 22-28-4238 | A-42375-0303 |
| 06 | 22-28-4068 | A-42375-0286 | 24 | 22-28-4248 | A-42375-0304 |
| 07 | 22-28-4078 | A-42375-0287 | 25 | 22-28-4258 | A-42375-0305 |
| 08 | 22-28-4088 | A-42375-0288 | 26 | 22-28-4268 | A-42375-0306 |
| 09 | 22-28-4098 | A-42375-0289 | 27 | 22-28-4278 | A-42375-0307 |
| 10 | 22-28-4108 | A-42375-0290 | 28 | 22-28-4288 | A-42375-0308 |
| 11 | 22-28-4118 | A-42375-0291 | 29 | 22-28-4298 | A-42375-0309 |
| 12 | 22-28-4128 | A-42375-0192 | 30 | 22-28-4308 | A-42375-0310 |
| 13 | 22-28-4138 | A-42375-0293 | 31 | 22-28-4318 | A-42375-0311 |
| 14 | 22-28-4148 | A-42375-0294 | 32 | 22-28-4328 | A-42375-0312 |
| 15 | 22-28-4158 | A-42375-0295 | 33 | 22-28-4338 | A-42375-0313 |
| 16 | 22-28-4168 | A-42375-0296 | 34 | 22-28-4348 | A-42375-0314 |
| 17 | 22-28-4178 | A-42375-0297 | 35 | 22-28-4358 | A-42375-0315 |
| 18 | 22-28-4188 | A-42375-0298 | 36 | 22-28-4368 | A-42375-0316 |
| 19 | 22-28-4198 | A-42375-0299 | | | |

ENG. NO: A-42375-0317/0351

| | |
|-------------------|--------------------|
| HEADER NUMBER: | 42312-0036 |
| PIN NUMBER: | 42663-ADA154 |
| PIN LENGTH: L | .465 / 11.81 |
| MATING LENGTH: M | .240 / 6.09 |
| GOLD POINT: G | N/A |
| PC TAIL LENGTH: P | .135 / 3.43 |
| TIN: T | OVERALL |
| CKTS: | 2-36 |
| KINKS: | SMES-42003 |
| VOIDED CKTS: | NONE |
| PACKAGING: | BULK PK-40873-0041 |

| CKTS | MATERIAL NUMBER | ENG NUMBER | CKTS | MATERIAL NUMBER | ENG NUMBER |
|------|-----------------|--------------|------|-----------------|--------------|
| 02 | 22-28-5020 | A-42375-0317 | 20 | 22-28-5200 | A-42375-0335 |
| 03 | 22-28-5030 | A-42375-0318 | 21 | 22-28-5210 | A-42375-0336 |
| 04 | 22-28-5040 | A-42375-0319 | 22 | 22-28-5220 | A-42375-0337 |
| 05 | 22-28-5050 | A-42375-0320 | 23 | 22-28-5230 | A-42375-0338 |
| 06 | 22-28-5060 | A-42375-0321 | 24 | 22-28-5240 | A-42375-0339 |
| 07 | 22-28-5070 | A-42375-0322 | 25 | 22-28-5250 | A-42375-0340 |
| 08 | 22-28-5080 | A-42375-0323 | 26 | 22-28-5260 | A-42375-0341 |
| 09 | 22-28-5090 | A-42375-0324 | 27 | 22-28-5270 | A-42375-0342 |
| 10 | 22-28-5100 | A-42375-0325 | 28 | 22-28-5280 | A-42375-0343 |
| 11 | 22-28-5110 | A-42375-0326 | 29 | 22-28-5290 | A-42375-0344 |
| 12 | 22-28-5120 | A-42375-0327 | 30 | 22-28-5300 | A-42375-0345 |
| 13 | 22-28-5130 | A-42375-0328 | 31 | 22-28-5310 | A-42375-0346 |
| 14 | 22-28-5140 | A-42375-0329 | 32 | 22-28-5320 | A-42375-0347 |
| 15 | 22-28-5150 | A-42375-0330 | 33 | 22-28-5330 | A-42375-0348 |
| 16 | 22-28-5160 | A-42375-0331 | 34 | 22-28-5340 | A-42375-0349 |
| 17 | 22-28-5170 | A-42375-0332 | 35 | 22-28-5350 | A-42375-0350 |
| 18 | 22-28-5180 | A-42375-0333 | 36 | 22-28-5360 | A-42375-0351 |
| 19 | 22-28-5190 | A-42375-0334 | | | |

REV:

UECR/ECN INFORMATION:EC No.: **UCP2017-2793**DATE: **12/20/2021**TITLE:

**KK 100 HEADER ASSY
FLAT VERTICAL
BREAKAWAY**

SHEET No.**- 6 -**DOCUMENT NUMBER:**SD- 42375-001**CREATED / REVISED BY:**SS06**CHECKED BY:**ISHWARG**APPROVED BY:**ISHWARG**

| ENG. NO: A-42375-0352/0386 | | | | | |
|----------------------------|-----------------|--------------------|------|-----------------|--------------|
| HEADER NUMBER: | | 42312-0036 | | | |
| PIN NUMBER: | | 42663-ADB208 | | | |
| PIN LENGTH: L | | .465 / 11.81 | | | |
| MATING LENGTH: M | | .240 / 6.09 | | | |
| GOLD POINT: G | | .100 / 2.54 | | | |
| PC TAIL LENGTH: P | | .135 / 3.43 | | | |
| TIN: T | | .100 / 2.54 | | | |
| CKTS: | | 2-36 | | | |
| KINKS: | | SMES-42003 | | | |
| VOIDED CKTS: | | NONE | | | |
| PACKAGING: | | BULK PK-40873-0041 | | | |
| CKTS | MATERIAL NUMBER | ENG NUMBER | CKTS | MATERIAL NUMBER | ENG NUMBER |
| 02 | 22-28-5023 | A-42375-0352 | 20 | 22-28-5203 | A-42375-0370 |
| 03 | 22-28-5033 | A-42375-0353 | 21 | 22-28-5213 | A-42375-0371 |
| 04 | 22-28-5043 | A-42375-0354 | 22 | 22-28-5223 | A-42375-0372 |
| 05 | 22-28-5053 | A-42375-0355 | 23 | 22-28-5233 | A-42375-0373 |
| 06 | 22-28-5063 | A-42375-0356 | 24 | 22-28-5243 | A-42375-0374 |
| 07 | 22-28-5073 | A-42375-0357 | 25 | 22-28-5253 | A-42375-0375 |
| 08 | 22-28-5083 | A-42375-0358 | 26 | 22-28-5263 | A-42375-0376 |
| 09 | 22-28-5093 | A-42375-0359 | 27 | 22-28-5273 | A-42375-0377 |
| 10 | 22-28-5103 | A-42375-0360 | 28 | 22-28-5283 | A-42375-0378 |
| 11 | 22-28-5113 | A-42375-0361 | 29 | 22-28-5293 | A-42375-0379 |
| 12 | 22-28-5123 | A-42375-0362 | 30 | 22-28-5303 | A-42375-0380 |
| 13 | 22-28-5133 | A-42375-0363 | 31 | 22-28-5313 | A-42375-0381 |
| 14 | 22-28-5143 | A-42375-0364 | 32 | 22-28-5323 | A-42375-0382 |
| 15 | 22-28-5153 | A-42375-0365 | 33 | 22-28-5333 | A-42375-0383 |
| 16 | 22-28-5163 | A-42375-0366 | 34 | 22-28-5343 | A-42375-0384 |
| 17 | 22-28-5173 | A-42375-0367 | 35 | 22-28-5353 | A-42375-0385 |
| 18 | 22-28-5183 | A-42375-0368 | 36 | 22-28-5363 | A-42375-0386 |
| 19 | 22-28-5193 | A-42375-0369 | | | |

| ENG. NO: A-42375-0387/0421 | | | | | |
|----------------------------|-----------------|--------------------|------|-----------------|--------------|
| HEADER NUMBER: | | 42312-0036 | | | |
| PIN NUMBER: | | 42663-ADB228 | | | |
| PIN LENGTH: L | | .465 / 11.81 | | | |
| MATING LENGTH: M | | .240 / 6.09 | | | |
| GOLD POINT: G | | .100 / 2.54 | | | |
| PC TAIL LENGTH: P | | .135 / 3.43 | | | |
| TIN: T | | .100 / 2.54 | | | |
| CKTS: | | 2-36 | | | |
| KINKS: | | SMES-42003 | | | |
| VOIDED CKTS: | | NONE | | | |
| PACKAGING: | | BULK PK-40873-0041 | | | |
| CKTS | MATERIAL NUMBER | ENG NUMBER | CKTS | MATERIAL NUMBER | ENG NUMBER |
| 02 | 22-28-5026 | A-42375-0387 | 20 | 22-28-5206 | A-42375-0405 |
| 03 | 22-28-5036 | A-42375-0388 | 21 | 22-28-5216 | A-42375-0406 |
| 04 | 22-28-5046 | A-42375-0389 | 22 | 22-28-5226 | A-42375-0407 |
| 05 | 22-28-5056 | A-42375-0390 | 23 | 22-28-5236 | A-42375-0408 |
| 06 | 22-28-5066 | A-42375-0391 | 24 | 22-28-5246 | A-42375-0409 |
| 07 | 22-28-5076 | A-42375-0392 | 25 | 22-28-5256 | A-42375-0410 |
| 08 | 22-28-5086 | A-42375-0393 | 26 | 22-28-5266 | A-42375-0411 |
| 09 | 22-28-5096 | A-42375-0394 | 27 | 22-28-5276 | A-42375-0412 |
| 10 | 22-28-5106 | A-42375-0395 | 28 | 22-28-5286 | A-42375-0413 |
| 11 | 22-28-5116 | A-42375-0396 | 29 | 22-28-5296 | A-42375-0414 |
| 12 | 22-28-5126 | A-42375-0397 | 30 | 22-28-5306 | A-42375-0415 |
| 13 | 22-28-5136 | A-42375-0398 | 31 | 22-28-5316 | A-42375-0416 |
| 14 | 22-28-5146 | A-42375-0399 | 32 | 22-28-5326 | A-42375-0417 |
| 15 | 22-28-5156 | A-42375-0400 | 33 | 22-28-5336 | A-42375-0418 |
| 16 | 22-28-5166 | A-42375-0401 | 34 | 22-28-5346 | A-42375-0419 |
| 17 | 22-28-5176 | A-42375-0402 | 35 | 22-28-5356 | A-42375-0420 |
| 18 | 22-28-5186 | A-42375-0403 | 36 | 22-28-5366 | A-42375-0421 |
| 19 | 22-28-5196 | A-42375-0404 | | | |

| | | | | |
|----------------------|------|-----------------------------|---|----------------|
| U | REV: | ECR/ECN INFORMATION: | TITLE: | SHEET No. |
| | | EC No.: UCP2017-2793 | KK 100 HEADER ASSY FLAT VERTICAL BREAKAWAY | - 7 - |
| | | DATE: 12/20/2021 | | |
| DOCUMENT NUMBER: | | CREATED / REVISED BY: | CHECKED BY: | APPROVED BY: |
| SD- 42375-001 | | SS06 | ISHWARG | ISHWARG |

| ENG. NO: A-42375-0422/0456 | | | | | |
|----------------------------|-----------------|--------------------|------|-----------------|--------------|
| HEADER NUMBER: | | 42312-0036 | | | |
| PIN NUMBER: | | 42663-AYA154 | | | |
| PIN LENGTH: L | | .545 / 13.84 | | | |
| MATING LENGTH: M | | .320 / 8.13 | | | |
| GOLD POINT: G | | N/A | | | |
| PC TAIL LENGTH: P | | .135 / 3.43 | | | |
| TIN: T | | OVERALL | | | |
| CKTS: | | 2-36 | | | |
| KINKS: | | SMES-42003 | | | |
| VOIDED CKTS: | | NONE | | | |
| PACKAGING: | | BULK PK-40873-0041 | | | |
| CKTS | MATERIAL NUMBER | ENG NUMBER | CKTS | MATERIAL NUMBER | ENG NUMBER |
| 02 | 22-28-5021 | A-42375-0422 | 20 | 22-28-5201 | A-42375-0440 |
| 03 | 22-28-5031 | A-42375-0423 | 21 | 22-28-5211 | A-42375-0441 |
| 04 | 22-28-5041 | A-42375-0424 | 22 | 22-28-5221 | A-42375-0442 |
| 05 | 22-28-5051 | A-42375-0425 | 23 | 22-28-5231 | A-42375-0443 |
| 06 | 22-28-5061 | A-42375-0426 | 24 | 22-28-5241 | A-42375-0444 |
| 07 | 22-28-5071 | A-42375-0427 | 25 | 22-28-5251 | A-42375-0445 |
| 08 | 22-28-5081 | A-42375-0428 | 26 | 22-28-5261 | A-42375-0446 |
| 09 | 22-28-5091 | A-42375-0429 | 27 | 22-28-5271 | A-42375-0447 |
| 10 | 22-28-5101 | A-42375-0430 | 28 | 22-28-5281 | A-42375-0448 |
| 11 | 22-28-5111 | A-42375-0431 | 29 | 22-28-5291 | A-42375-0449 |
| 12 | 22-28-5121 | A-42375-0432 | 30 | 22-28-5301 | A-42375-0450 |
| 13 | 22-28-5131 | A-42375-0433 | 31 | 22-28-5311 | A-42375-0451 |
| 14 | 22-28-5141 | A-42375-0434 | 32 | 22-28-5321 | A-42375-0452 |
| 15 | 22-28-5151 | A-42375-0435 | 33 | 22-28-5331 | A-42375-0453 |
| 16 | 22-28-5161 | A-42375-0436 | 34 | 22-28-5341 | A-42375-0454 |
| 17 | 22-28-5171 | A-42375-0437 | 35 | 22-28-5351 | A-42375-0455 |
| 18 | 22-28-5181 | A-42375-0438 | 36 | 22-28-5361 | A-42375-0456 |
| 19 | 22-28-5191 | A-42375-0439 | | | |

| ENG. NO: A-42375-0457/0491 | | | | | |
|----------------------------|-----------------|--------------------|------|-----------------|--------------|
| HEADER NUMBER: | | 42312-0036 | | | |
| PIN NUMBER: | | 42663-AYB208 | | | |
| PIN LENGTH: L | | .545 / 13.84 | | | |
| MATING LENGTH: M | | .320 / 8.13 | | | |
| GOLD POINT: G | | .140 / 3.56 | | | |
| PC TAIL LENGTH: P | | .135 / 3.43 | | | |
| TIN: T | | .135 / 3.43 | | | |
| CKTS: | | 2-36 | | | |
| KINKS: | | SMES-42003 | | | |
| VOIDED CKTS: | | NONE | | | |
| PACKAGING: | | BULK PK-40873-0041 | | | |
| CKTS | MATERIAL NUMBER | ENG NUMBER | CKTS | MATERIAL NUMBER | ENG NUMBER |
| 02 | 22-28-5024 | A-42375-0457 | 20 | 22-28-5204 | A-42375-0475 |
| 03 | 22-28-5034 | A-42375-0458 | 21 | 22-28-5214 | A-42375-0476 |
| 04 | 22-28-5044 | A-42375-0459 | 22 | 22-28-5224 | A-42375-0477 |
| 05 | 22-28-5054 | A-42375-0460 | 23 | 22-28-5234 | A-42375-0478 |
| 06 | 22-28-5064 | A-42375-0461 | 24 | 22-28-5244 | A-42375-0479 |
| 07 | 22-28-5074 | A-42375-0462 | 25 | 22-28-5254 | A-42375-0480 |
| 08 | 22-28-5084 | A-42375-0463 | 26 | 22-28-5264 | A-42375-0481 |
| 09 | 22-28-5094 | A-42375-0464 | 27 | 22-28-5274 | A-42375-0482 |
| 10 | 22-28-5104 | A-42375-0465 | 28 | 22-28-5284 | A-42375-0483 |
| 11 | 22-28-5114 | A-42375-0466 | 29 | 22-28-5294 | A-42375-0484 |
| 12 | 22-28-5124 | A-42375-0467 | 30 | 22-28-5304 | A-42375-0485 |
| 13 | 22-28-5134 | A-42375-0468 | 31 | 22-28-5314 | A-42375-0486 |
| 14 | 22-28-5144 | A-42375-0469 | 32 | 22-28-5324 | A-42375-0487 |
| 15 | 22-28-5154 | A-42375-0470 | 33 | 22-28-5334 | A-42375-0488 |
| 16 | 22-28-5164 | A-42375-0471 | 34 | 22-28-5344 | A-42375-0489 |
| 17 | 22-28-5174 | A-42375-0472 | 35 | 22-28-5354 | A-42375-0490 |
| 18 | 22-28-5184 | A-42375-0473 | 36 | 22-28-5364 | A-42375-0491 |
| 19 | 22-28-5194 | A-42375-0474 | | | |

| | | | | |
|-------------------------|------|------------------------------|---|---------------------|
| U | REV: | <u>ECR/ECN INFORMATION:</u> | <u>TITLE:</u> | <u>SHEET No.</u> |
| | | EC No.: UCP2017-2793 | KK 100 HEADER ASSY FLAT VERTICAL BREAKAWAY | - 8 - |
| | | DATE: 12/20/2021 | | |
| <u>DOCUMENT NUMBER:</u> | | <u>CREATED / REVISED BY:</u> | <u>CHECKED BY:</u> | <u>APPROVED BY:</u> |
| SD- 42375-001 | | SS06 | ISHWARG | ISHWARG |

| ENG. NO: A-42375-0492/0526 | | | | | |
|----------------------------|-----------------|--------------------|------|-----------------|--------------|
| HEADER NUMBER: | | 42312-0036 | | | |
| PIN NUMBER: | | 42663-AYB228 | | | |
| PIN LENGTH: L | | .545 / 13.84 | | | |
| MATING LENGTH: M | | .320 / 8.13 | | | |
| GOLD POINT: G | | .140 / 3.56 | | | |
| PC TAIL LENGTH: P | | .135 / 3.43 | | | |
| TIN: T | | .135 / 3.43 | | | |
| CKTS: | | 2-36 | | | |
| KINKS: | | SMES-42003 | | | |
| VOIDED CKTS: | | NONE | | | |
| PACKAGING: | | BULK PK-40873-0041 | | | |
| CKTS | MATERIAL NUMBER | ENG NUMBER | CKTS | MATERIAL NUMBER | ENG NUMBER |
| 02 | 22-28-5027 | A-42375-0492 | 20 | 22-28-5207 | A-42375-0510 |
| 03 | 22-28-5037 | A-42375-0493 | 21 | 22-28-5217 | A-42375-0511 |
| 04 | 22-28-5047 | A-42375-0494 | 22 | 22-28-5227 | A-42375-0512 |
| 05 | 22-28-5057 | A-42375-0495 | 23 | 22-28-5237 | A-42375-0513 |
| 06 | 22-28-5067 | A-42375-0496 | 24 | 22-28-5247 | A-42375-0514 |
| 07 | 22-28-5077 | A-42375-0497 | 25 | 22-28-5257 | A-42375-0515 |
| 08 | 22-28-5087 | A-42375-0498 | 26 | 22-28-5267 | A-42375-0516 |
| 09 | 22-28-5097 | A-42375-0499 | 27 | 22-28-5277 | A-42375-0517 |
| 10 | 22-28-5107 | A-42375-0500 | 28 | 22-28-5287 | A-42375-0518 |
| 11 | 22-28-5117 | A-42375-0501 | 29 | 22-28-5297 | A-42375-0519 |
| 12 | 22-28-5127 | A-42375-0502 | 30 | 22-28-5307 | A-42375-0520 |
| 13 | 22-28-5137 | A-42375-0503 | 31 | 22-28-5317 | A-42375-0521 |
| 14 | 22-28-5147 | A-42375-0504 | 32 | 22-28-5327 | A-42375-0522 |
| 15 | 22-28-5157 | A-42375-0505 | 33 | 22-28-5337 | A-42375-0523 |
| 16 | 22-28-5167 | A-42375-0506 | 34 | 22-28-5347 | A-42375-0524 |
| 17 | 22-28-5177 | A-42375-0507 | 35 | 22-28-5357 | A-42375-0525 |
| 18 | 22-28-5187 | A-42375-0508 | 36 | 22-28-5367 | A-42375-0526 |
| 19 | 22-28-5197 | A-42375-0509 | | | |

| ENG. NO: A-42375-0527/0561 | | | | | |
|----------------------------|-----------------|--------------------|------|-----------------|--------------|
| HEADER NUMBER: | | 42312-0036 | | | |
| PIN NUMBER: | | 42663-ARA154 | | | |
| PIN LENGTH: L | | .520 / 13.21 | | | |
| MATING LENGTH: M | | .295 / 7.49 | | | |
| GOLD POINT: G | | N/A | | | |
| PC TAIL LENGTH: P | | .135 / 3.43 | | | |
| TIN: T | | OVERALL | | | |
| CKTS: | | 2-36 | | | |
| KINKS: | | SMES-42003 | | | |
| VOIDED CKTS: | | NONE | | | |
| PACKAGING: | | BULK PK-40873-0041 | | | |
| CKTS | MATERIAL NUMBER | ENG NUMBER | CKTS | MATERIAL NUMBER | ENG NUMBER |
| 02 | 22-28-5022 | A-42375-0527 | 20 | 22-28-5202 | A-42375-0545 |
| 03 | 22-28-5032 | A-42375-0528 | 21 | 22-28-5212 | A-42375-0546 |
| 04 | 22-28-5042 | A-42375-0529 | 22 | 22-28-5222 | A-42375-0547 |
| 05 | 22-28-5052 | A-42375-0530 | 23 | 22-28-5232 | A-42375-0548 |
| 06 | 22-28-5062 | A-42375-0531 | 24 | 22-28-5242 | A-42375-0549 |
| 07 | 22-28-5072 | A-42375-0532 | 25 | 22-28-5252 | A-42375-0550 |
| 08 | 22-28-5082 | A-42375-0533 | 26 | 22-28-5262 | A-42375-0551 |
| 09 | 22-28-5092 | A-42375-0534 | 27 | 22-28-5272 | A-42375-0552 |
| 10 | 22-28-5102 | A-42375-0535 | 28 | 22-28-5282 | A-42375-0553 |
| 11 | 22-28-5112 | A-42375-0536 | 29 | 22-28-5292 | A-42375-0554 |
| 12 | 22-28-5122 | A-42375-0537 | 30 | 22-28-5302 | A-42375-0555 |
| 13 | 22-28-5132 | A-42375-0538 | 31 | 22-28-5312 | A-42375-0556 |
| 14 | 22-28-5142 | A-42375-0539 | 32 | 22-28-5322 | A-42375-0557 |
| 15 | 22-28-5152 | A-42375-0540 | 33 | 22-28-5332 | A-42375-0558 |
| 16 | 22-28-5162 | A-42375-0541 | 34 | 22-28-5342 | A-42375-0559 |
| 17 | 22-28-5172 | A-42375-0542 | 35 | 22-28-5352 | A-42375-0560 |
| 18 | 22-28-5182 | A-42375-0543 | 36 | 22-28-5362 | A-42375-0561 |
| 19 | 22-28-5192 | A-42375-0544 | | | |

| | | | | |
|---|------|---|---|---------------------------------------|
| U | REV: | <u>ECR/ECN INFORMATION:</u> | <u>TITLE:</u> | <u>SHEET No.</u> |
| | | EC No.: UCP2017-2793 | KK 100 HEADER ASSY FLAT VERTICAL BREAKAWAY | - 9 - |
| | | DATE: 12/20/2021 | | |
| <u>DOCUMENT NUMBER:</u> SD- 42375-001 | | <u>CREATED / REVISED BY:</u> SS06 | <u>CHECKED BY:</u> ISHWARG | <u>APPROVED BY:</u> ISHWARG |

| ENG. NO: A-42375-0562/0596 | | | | | |
|----------------------------|-----------------|--------------------|------|-----------------|--------------|
| HEADER NUMBER: | | 42312-0036 | | | |
| PIN NUMBER: | | 42663-ARB208 | | | |
| PIN LENGTH: L | | .520 / 13.21 | | | |
| MATING LENGTH: M | | .295 / 7.49 | | | |
| GOLD POINT: G | | .140 / 3.56 | | | |
| PC TAIL LENGTH: P | | .135 / 3.43 | | | |
| TIN: T | | .135 / 3.43 | | | |
| CKTS: | | 2-36 | | | |
| KINKS: | | SMES-42003 | | | |
| VOIDED CKTS: | | NONE | | | |
| PACKAGING: | | BULK PK-40873-0041 | | | |
| CKTS | MATERIAL NUMBER | ENG NUMBER | CKTS | MATERIAL NUMBER | ENG NUMBER |
| 02 | 22-28-5025 | A-42375-0562 | 20 | 22-28-5205 | A-42375-0580 |
| 03 | 22-28-5035 | A-42375-0563 | 21 | 22-28-5215 | A-42375-0581 |
| 04 | 22-28-5045 | A-42375-0564 | 22 | 22-28-5225 | A-42375-0582 |
| 05 | 22-28-5055 | A-42375-0565 | 23 | 22-28-5235 | A-42375-0583 |
| 06 | 22-28-5065 | A-42375-0566 | 24 | 22-28-5245 | A-42375-0584 |
| 07 | 22-28-5075 | A-42375-0567 | 25 | 22-28-5255 | A-42375-0585 |
| 08 | 22-28-5085 | A-42375-0568 | 26 | 22-28-5265 | A-42375-0586 |
| 09 | 22-28-5095 | A-42375-0569 | 27 | 22-28-5275 | A-42375-0587 |
| 10 | 22-28-5105 | A-42375-0570 | 28 | 22-28-5285 | A-42375-0588 |
| 11 | 22-28-5115 | A-42375-0571 | 29 | 22-28-5295 | A-42375-0589 |
| 12 | 22-28-5125 | A-42375-0572 | 30 | 22-28-5305 | A-42375-0590 |
| 13 | 22-28-5135 | A-42375-0573 | 31 | 22-28-5315 | A-42375-0591 |
| 14 | 22-28-5145 | A-42375-0574 | 32 | 22-28-5325 | A-42375-0592 |
| 15 | 22-28-5155 | A-42375-0575 | 33 | 22-28-5335 | A-42375-0593 |
| 16 | 22-28-5165 | A-42375-0576 | 34 | 22-28-5345 | A-42375-0594 |
| 17 | 22-28-5175 | A-42375-0577 | 35 | 22-28-5355 | A-42375-0595 |
| 18 | 22-28-5185 | A-42375-0578 | 36 | 22-28-5365 | A-42375-0596 |
| 19 | 22-28-5195 | A-42375-0579 | | | |

| ENG. NO: A-42375-0597/0631 | | | | | |
|----------------------------|-----------------|--------------------|------|-----------------|--------------|
| HEADER NUMBER: | | 42312-0036 | | | |
| PIN NUMBER: | | 42663-ARB228 | | | |
| PIN LENGTH: L | | .520 / 13.21 | | | |
| MATING LENGTH: M | | .295 / 7.49 | | | |
| GOLD POINT: G | | .140 / 3.56 | | | |
| PC TAIL LENGTH: P | | .135 / 3.43 | | | |
| TIN: T | | .135 / 3.43 | | | |
| CKTS: | | 2-36 | | | |
| KINKS: | | SMES-42003 | | | |
| VOIDED CKTS: | | NONE | | | |
| PACKAGING: | | BULK PK-40873-0041 | | | |
| CKTS | MATERIAL NUMBER | ENG NUMBER | CKTS | MATERIAL NUMBER | ENG NUMBER |
| 02 | 22-28-5028 | A-42375-0597 | 20 | 22-28-5208 | A-42375-0615 |
| 03 | 22-28-5038 | A-42375-0598 | 21 | 22-28-5218 | A-42375-0616 |
| 04 | 22-28-5048 | A-42375-0599 | 22 | 22-28-5228 | A-42375-0617 |
| 05 | 22-28-5058 | A-42375-0600 | 23 | 22-28-5238 | A-42375-0618 |
| 06 | 22-28-5068 | A-42375-0601 | 24 | 22-28-5248 | A-42375-0619 |
| 07 | 22-28-5078 | A-42375-0602 | 25 | 22-28-5258 | A-42375-0620 |
| 08 | 22-28-5088 | A-42375-0603 | 26 | 22-28-5268 | A-42375-0621 |
| 09 | 22-28-5098 | A-42375-0604 | 27 | 22-28-5278 | A-42375-0622 |
| 10 | 22-28-5108 | A-42375-0605 | 28 | 22-28-5288 | A-42375-0623 |
| 11 | 22-28-5118 | A-42375-0606 | 29 | 22-28-5298 | A-42375-0624 |
| 12 | 22-28-5128 | A-42375-0607 | 30 | 22-28-5308 | A-42375-0625 |
| 13 | 22-28-5138 | A-42375-0608 | 31 | 22-28-5318 | A-42375-0626 |
| 14 | 22-28-5148 | A-42375-0609 | 32 | 22-28-5328 | A-42375-0627 |
| 15 | 22-28-5158 | A-42375-0610 | 33 | 22-28-5338 | A-42375-0628 |
| 16 | 22-28-5168 | A-42375-0611 | 34 | 22-28-5348 | A-42375-0629 |
| 17 | 22-28-5178 | A-42375-0612 | 35 | 22-28-5358 | A-42375-0630 |
| 18 | 22-28-5188 | A-42375-0613 | 36 | 22-28-5368 | A-42375-0631 |
| 19 | 22-28-5198 | A-42375-0614 | | | |

| | | | | | |
|-------------------------|------|------------------------------|--------------------|---|------------------|
| U | REV: | <u>ECR/ECN INFORMATION:</u> | <u>TITLE:</u> | KK 100 HEADER ASSY FLAT VERTICAL BREAKAWAY | <u>SHEET No.</u> |
| | | EC No.: UCP2017-2793 | | | - 10 - |
| | | DATE: 12/20/2021 | | | |
| <u>DOCUMENT NUMBER:</u> | | <u>CREATED / REVISED BY:</u> | <u>CHECKED BY:</u> | <u>APPROVED BY:</u> | |
| SD- 42375-001 | | SS06 | ISHWARG | ISHWARG | |

ENG. NO: A-42375-0667/0699

| HEADER NUMBER: | | 42312-0036 | | | |
|-------------------|-----------------|--------------------|------|-----------------|--------------|
| PIN NUMBER: | | 42663-ABB208 | | | |
| PIN LENGTH: L | | .455 / 11.56 | | | |
| MATING LENGTH: M | | .240 / 6.09 | | | |
| GOLD POINT: G | | .100 / 2.54 | | | |
| PC TAIL LENGTH: P | | .125 / 3.18 | | | |
| TIN: T | | .100 / 2.54 | | | |
| CKTS: | | 4-36 | | | |
| KINKS: | | NO | | | |
| VOIDED CKTS: | | 4 | | | |
| PACKAGING: | | BULK PK-40873-0041 | | | |
| CKTS | MATERIAL NUMBER | ENG NUMBER | CKTS | MATERIAL NUMBER | ENG NUMBER |
| 02 | | | 20 | 42375-0683 | A-42375-0683 |
| 03 | | | 21 | 42375-0684 | A-42375-0684 |
| 04 | 42375-0667 | A-42375-0667 | 22 | 42375-0685 | A-42375-0685 |
| 05 | 42375-0668 | A-42375-0668 | 23 | 42375-0686 | A-42375-0686 |
| 06 | 22-30-3060 | A-42375-0669 | 24 | 42375-0687 | A-42375-0687 |
| 07 | 42375-0670 | A-42375-0670 | 25 | 42375-0688 | A-42375-0688 |
| 08 | 42375-0671 | A-42375-0671 | 26 | 42375-0689 | A-42375-0689 |
| 09 | 42375-0672 | A-42375-0672 | 27 | 42375-0690 | A-42375-0690 |
| 10 | 42375-0673 | A-42375-0673 | 28 | 42375-0691 | A-42375-0691 |
| 11 | 42375-0674 | A-42375-0674 | 29 | 42375-0692 | A-42375-0692 |
| 12 | 22-30-3120 | A-42375-0675 | 30 | 42375-0693 | A-42375-0693 |
| 13 | 42375-0676 | A-42375-0676 | 31 | 42375-0694 | A-42375-0694 |
| 14 | 42375-0677 | A-42375-0677 | 32 | 42375-0695 | A-42375-0695 |
| 15 | 42375-0678 | A-42375-0678 | 33 | 42375-0696 | A-42375-0696 |
| 16 | 42375-0679 | A-42375-0679 | 34 | 42375-0697 | A-42375-0697 |
| 17 | 42375-0680 | A-42375-0680 | 35 | 42375-0698 | A-42375-0698 |
| 18 | 42375-0681 | A-42375-0681 | 36 | 42375-0699 | A-42375-0699 |
| 19 | 42375-0682 | A-42375-0682 | | | |

ENG. NO: A-42375-0700/0732

| HEADER NUMBER: | | 42312-0036 | | | |
|-------------------|-----------------|--------------------|------|-----------------|--------------|
| PIN NUMBER: | | 42663-ADB208 | | | |
| PIN LENGTH: L | | .465 / 11.81 | | | |
| MATING LENGTH: M | | .240 / 6.09 | | | |
| GOLD POINT: G | | .100 / 2.54 | | | |
| PC TAIL LENGTH: P | | .135 / 3.43 | | | |
| TIN: T | | .100 / 2.54 | | | |
| CKTS: | | 4-36 | | | |
| KINKS: | | SMES-42003 | | | |
| VOIDED CKTS: | | 4 | | | |
| PACKAGING: | | BULK PK-40873-0041 | | | |
| CKTS | MATERIAL NUMBER | ENG NUMBER | CKTS | MATERIAL NUMBER | ENG NUMBER |
| 02 | | | 20 | 42375-0716 | A-42375-0716 |
| 03 | | | 21 | 42375-0717 | A-42375-0717 |
| 04 | 42375-0700 | A-42375-0700 | 22 | 42375-0718 | A-42375-0718 |
| 05 | 42375-0701 | A-42375-0701 | 23 | 42375-0719 | A-42375-0719 |
| 06 | 22-30-3061 | A-42375-0702 | 24 | 42375-0720 | A-42375-0720 |
| 07 | 42375-0703 | A-42375-0703 | 25 | 42375-0721 | A-42375-0721 |
| 08 | 42375-0704 | A-42375-0704 | 26 | 42375-0722 | A-42375-0722 |
| 09 | 42375-0705 | A-42375-0705 | 27 | 42375-0723 | A-42375-0723 |
| 10 | 42375-0706 | A-42375-0706 | 28 | 42375-0724 | A-42375-0724 |
| 11 | 42375-0707 | A-42375-0707 | 29 | 42375-0725 | A-42375-0725 |
| 12 | 42375-0708 | A-42375-0708 | 30 | 42375-0726 | A-42375-0726 |
| 13 | 42375-0709 | A-42375-0709 | 31 | 42375-0727 | A-42375-0727 |
| 14 | 42375-0710 | A-42375-0710 | 32 | 42375-0728 | A-42375-0728 |
| 15 | 42375-0711 | A-42375-0711 | 33 | 42375-0729 | A-42375-0729 |
| 16 | 42375-0712 | A-42375-0712 | 34 | 42375-0730 | A-42375-0730 |
| 17 | 42375-0713 | A-42375-0713 | 35 | 42375-0731 | A-42375-0731 |
| 18 | 42375-0714 | A-42375-0714 | 36 | 42375-0732 | A-42375-0732 |
| 19 | 42375-0715 | A-42375-0715 | | | |

| | | | | | |
|-------------------------|------|------------------------------|--------------------|---|------------------|
| U | REV: | <u>ECR/ECN INFORMATION:</u> | <u>TITLE:</u> | KK 100 HEADER ASSY FLAT VERTICAL BREAKAWAY | <u>SHEET No.</u> |
| | | EC No.: UCP2017-2793 | | | - 11 - |
| | | DATE: 12/20/2021 | | | |
| <u>DOCUMENT NUMBER:</u> | | <u>CREATED / REVISED BY:</u> | <u>CHECKED BY:</u> | <u>APPROVED BY:</u> | |
| SD- 42375-001 | | SS06 | ISHWARG | ISHWARG | |

ENG. NO: A-42375-0836/0870

| | |
|-------------------|--------------------|
| HEADER NUMBER: | 42312-0036 |
| PIN NUMBER: | 42663-BSA154 |
| PIN LENGTH: L | .630 / 16.00 |
| MATING LENGTH: M | .405/10.29 |
| GOLD POINT: G | N/A |
| PC TAIL LENGTH: P | .135/3.43 |
| TIN: T | OVERALL |
| CKTS: | 2-36 |
| KINKS: | SMES-42003 |
| VOIDED CKTS: | NONE |
| PACKAGING: | BULK PK-40873-0041 |

| CKTS | MATERIAL NUMBER | ENG NUMBER | CKTS | MATERIAL NUMBER | ENG NUMBER |
|------|-----------------|--------------|------|-----------------|--------------|
| 02 | | A-42375-0836 | 20 | 22-30-3203 | A-42375-0854 |
| 03 | 22-30-3033 | A-42375-0837 | 21 | 22-30-3213 | A-42375-0855 |
| 04 | 22-30-3043 | A-42375-0838 | 22 | 22-30-3223 | A-42375-0856 |
| 05 | 22-30-3053 | A-42375-0839 | 23 | 22-30-3233 | A-42375-0857 |
| 06 | 22-30-3063 | A-42375-0840 | 24 | 22-30-3243 | A-42375-0858 |
| 07 | 22-30-3073 | A-42375-0841 | 25 | 22-30-3253 | A-42375-0859 |
| 08 | 22-30-3083 | A-42375-0842 | 26 | 22-30-3263 | A-42375-0860 |
| 09 | 22-30-3093 | A-42375-0843 | 27 | 22-30-3273 | A-42375-0861 |
| 10 | 22-30-3103 | A-42375-0844 | 28 | 22-30-3283 | A-42375-0862 |
| 11 | 22-30-3113 | A-42375-0845 | 29 | 22-30-3293 | A-42375-0863 |
| 12 | 22-30-3123 | A-42375-0846 | 30 | 22-30-3303 | A-42375-0864 |
| 13 | 22-30-3133 | A-42375-0847 | 31 | 22-30-3313 | A-42375-0865 |
| 14 | 22-30-3143 | A-42375-0848 | 32 | 22-30-3323 | A-42375-0866 |
| 15 | 22-30-3153 | A-42375-0849 | 33 | 22-30-3333 | A-42375-0867 |
| 16 | 22-30-3163 | A-42375-0850 | 34 | 22-30-3343 | A-42375-0868 |
| 17 | 22-30-3173 | A-42375-0851 | 35 | 22-30-3353 | A-42375-0869 |
| 18 | 22-30-3183 | A-42375-0852 | 36 | 22-30-3363 | A-42375-0870 |
| 19 | 22-30-3193 | A-42375-0853 | | | |
| | | | | | |

| | | | |
|--|--|---|--------------------------------|
| REV: U | ECR/ECN INFORMATION: EC No.: UCP2017-2793 DATE: 12/20/2021 | TITLE: KK 100 HEADER ASSY FLAT VERTICAL BREAKAWAY | SHEET No. - 12 - |
| DOCUMENT NUMBER: SD- 42375-001 | CREATED / REVISED BY: SS06 | CHECKED BY: ISHWARG | APPROVED BY: ISHWARG |

| ENG. NO: A-42375-0871/0904 | | | | | |
|----------------------------|-----------------|--------------------|------|-----------------|--------------|
| HEADER NUMBER: | | 42312-0036 | | | |
| PIN NUMBER: | | 42663-ATA154 | | | |
| PIN LENGTH: L | | .530 / 13.46 | | | |
| MATING LENGTH: M | | .320 / 8.13 | | | |
| GOLD POINT: G | | N/A | | | |
| PC TAIL LENGTH: P | | .120 / 3.05 | | | |
| TIN: T | | OVERALL | | | |
| CKTS: | | 3-36 | | | |
| KINKS: | | NO | | | |
| VOIDED CKTS: | | 2 | | | |
| PACKAGING: | | BULK PK-40873-0041 | | | |
| CKTS | MATERIAL NUMBER | ENG NUMBER | CKTS | MATERIAL NUMBER | ENG NUMBER |
| 02 | | | 20 | 22-30-3204 | A-42375-0888 |
| 03 | 22-30-3034 | A-42375-0871 | 21 | 22-30-3214 | A-42375-0889 |
| 04 | 22-30-3044 | A-42375-0872 | 22 | 22-30-3224 | A-42375-0890 |
| 05 | 22-30-3054 | A-42375-0873 | 23 | 22-30-3234 | A-42375-0891 |
| 06 | 22-30-3064 | A-42375-0874 | 24 | 22-30-3244 | A-42375-0892 |
| 07 | 22-30-3074 | A-42375-0875 | 25 | 22-30-3254 | A-42375-0893 |
| 08 | 22-30-3084 | A-42375-0876 | 26 | 22-30-3264 | A-42375-0894 |
| 09 | 22-30-3094 | A-42375-0877 | 27 | 22-30-3274 | A-42375-0895 |
| 10 | 22-30-3104 | A-42375-0878 | 28 | 22-30-3284 | A-42375-0896 |
| 11 | 22-30-3114 | A-42375-0879 | 29 | 22-30-3294 | A-42375-0897 |
| 12 | 22-30-3124 | A-42375-0880 | 30 | 22-30-3304 | A-42375-0898 |
| 13 | 22-30-3134 | A-42375-0881 | 31 | 22-30-3314 | A-42375-0899 |
| 14 | 22-30-3144 | A-42375-0882 | 32 | 22-30-3324 | A-42375-0900 |
| 15 | 22-30-3154 | A-42375-0883 | 33 | 22-30-3334 | A-42375-0901 |
| 16 | 22-30-3164 | A-42375-0884 | 34 | 22-30-3344 | A-42375-0902 |
| 17 | 22-30-3174 | A-42375-0885 | 35 | 22-30-3354 | A-42375-0903 |
| 18 | 22-30-3184 | A-42375-0886 | 36 | 22-30-3364 | A-42375-0904 |
| 19 | 22-30-3194 | A-42375-0887 | | | |

| ENG. NO: A-42375-0973/1001 | | | | | |
|----------------------------|-----------------|--------------------|------|-----------------|--------------|
| HEADER NUMBER: | | 42312-0036 | | | |
| PIN NUMBER: | | 42663-ABA154 | | | |
| PIN LENGTH: L | | .455 / 11.56 | | | |
| MATING LENGTH: M | | .240 / 6.09 | | | |
| GOLD POINT: G | | N/A | | | |
| PC TAIL LENGTH: P | | .125 / 3.18 | | | |
| TIN: T | | OVERALL | | | |
| CKTS: | | 8-36 | | | |
| KINKS: | | NO | | | |
| VOIDED CKTS: | | 3,8 | | | |
| PACKAGING: | | BULK PK-40873-0041 | | | |
| CKTS | MATERIAL NUMBER | ENG NUMBER | CKTS | MATERIAL NUMBER | ENG NUMBER |
| 02 | | | 20 | 42375-0985 | A-42375-0985 |
| 03 | | | 21 | 42375-0986 | A-42375-0986 |
| 04 | | | 22 | 42375-0987 | A-42375-0987 |
| 05 | | | 23 | 42375-0988 | A-42375-0988 |
| 06 | | | 24 | 42375-0989 | A-42375-0989 |
| 07 | | | 25 | 42375-0990 | A-42375-0990 |
| 08 | 42375-0973 | A-42375-0973 | 26 | 42375-0991 | A-42375-0991 |
| 09 | 42375-0974 | A-42375-0974 | 27 | 42375-0992 | A-42375-0992 |
| 10 | 22-30-3107 | A-42375-0975 | 28 | 42375-0993 | A-42375-0993 |
| 11 | 42375-0976 | A-42375-0976 | 29 | 42375-0994 | A-42375-0994 |
| 12 | 42375-0977 | A-42375-0977 | 30 | 42375-0995 | A-42375-0995 |
| 13 | 42375-0978 | A-42375-0978 | 31 | 42375-0996 | A-42375-0996 |
| 14 | 42375-0979 | A-42375-0979 | 32 | 42375-0997 | A-42375-0997 |
| 15 | 42375-0980 | A-42375-0980 | 33 | 42375-0998 | A-42375-0998 |
| 16 | 42375-0981 | A-42375-0981 | 34 | 42375-0999 | A-42375-0999 |
| 17 | 42375-0982 | A-42375-0982 | 35 | 42375-1000 | A-42375-1000 |
| 18 | 42375-0983 | A-42375-0983 | 36 | 42375-1001 | A-42375-1001 |
| 19 | 42375-0984 | A-42375-0984 | | | |

| | | | | | |
|-------------------------|------|------------------------------|--------------------|---|------------------|
| U | REV: | <u>ECR/ECN INFORMATION:</u> | <u>TITLE:</u> | KK 100 HEADER ASSY FLAT VERTICAL BREAKAWAY | <u>SHEET No.</u> |
| | | EC No.: UCP2017-2793 | | | - 13 - |
| | | DATE: 12/20/2021 | | | |
| <u>DOCUMENT NUMBER:</u> | | <u>CREATED / REVISED BY:</u> | <u>CHECKED BY:</u> | <u>APPROVED BY:</u> | |
| SD- 42375-001 | | SS06 | ISHWARG | ISHWARG | |

ENG. NO: A-42375-1105/1139

| | |
|-------------------|--------------------|
| HEADER NUMBER: | 42312-0036 |
| PIN NUMBER: | 42663-ABB208 |
| PIN LENGTH: L | .455 / 11.56 |
| MATING LENGTH: M | .240 / 6.09 |
| GOLD POINT: G | .100 / 2.54 |
| PC TAIL LENGTH: P | .125 / 3.18 |
| TIN: T | .100 / 2.54 |
| CKTS: | 2-36 |
| KINKS: | NO |
| VOIDED CKTS: | 2 |
| PACKAGING: | BULK PK-40873-0041 |

| CKTS | MATERIAL NUMBER | ENG NUMBER | CKTS | MATERIAL NUMBER | ENG NUMBER |
|------|-----------------|--------------|------|-----------------|--------------|
| 02 | 42375-1105 | A-42375-1105 | 20 | 42375-1123 | A-42375-1123 |
| 03 | 42375-1106 | A-42375-1106 | 21 | 42375-1124 | A-42375-1124 |
| 04 | 42375-1107 | A-42375-1107 | 22 | 42375-1125 | A-42375-1125 |
| 05 | 42375-1108 | A-42375-1108 | 23 | 42375-1126 | A-42375-1126 |
| 06 | 42375-1109 | A-42375-1109 | 24 | 42375-1127 | A-42375-1127 |
| 07 | 42375-1110 | A-42375-1110 | 25 | 42375-1128 | A-42375-1128 |
| 08 | 42375-1111 | A-42375-1111 | 26 | 42375-1129 | A-42375-1129 |
| 09 | 22-30-3099 | A-42375-1112 | 27 | 42375-1130 | A-42375-1130 |
| 10 | 42375-1113 | A-42375-1113 | 28 | 42375-1131 | A-42375-1131 |
| 11 | 42375-1114 | A-42375-1114 | 29 | 42375-1132 | A-42375-1132 |
| 12 | 42375-1115 | A-42375-1115 | 30 | 42375-1133 | A-42375-1133 |
| 13 | 42375-1116 | A-42375-1116 | 31 | 42375-1134 | A-42375-1134 |
| 14 | 42375-1117 | A-42375-1117 | 32 | 42375-1135 | A-42375-1135 |
| 15 | 42375-1118 | A-42375-1118 | 33 | 42375-1136 | A-42375-1136 |
| 16 | 42375-1119 | A-42375-1119 | 34 | 42375-1137 | A-42375-1137 |
| 17 | 42375-1120 | A-42375-1120 | 35 | 42375-1138 | A-42375-1138 |
| 18 | 42375-1121 | A-42375-1121 | 36 | 42375-1139 | A-42375-1139 |
| 19 | 42375-1122 | A-42375-1122 | | | |

ENG. NO: 42375-1244/1278

| | |
|-------------------|--------------------|
| HEADER NUMBER: | 42312-0036 |
| PIN NUMBER: | 42663-ABA154 |
| PIN LENGTH: L | .455 / 11.56 |
| MATING LENGTH: M | .240 / 6.09 |
| GOLD POINT: G | N/A |
| PC TAIL LENGTH: P | .125 / 3.18 |
| TIN: T | OVERALL |
| CKTS: | 2-36 |
| KINKS: | NO |
| VOIDED CKTS: | 2 |
| PACKAGING: | BULK PK-40873-0041 |

| CKTS | ITEM NUMBER | CKTS | ITEM NUMBER |
|------|-------------|------|-------------|
| 02 | 42375-1244 | 20 | 42375-1262 |
| 03 | 42375-1245 | 21 | 42375-1263 |
| 04 | 42375-1246 | 22 | 42375-1264 |
| 05 | 42375-1247 | 23 | 42375-1265 |
| 06 | 42375-1248 | 24 | 42375-1266 |
| 07 | 42375-1249 | 25 | 42375-1267 |
| 08 | 42375-1250 | 26 | 42375-1268 |
| 09 | 42375-1251 | 27 | 42375-1269 |
| 10 | 42375-1252 | 28 | 42375-1270 |
| 11 | 42375-1253 | 29 | 42375-1271 |
| 12 | 42375-1254 | 30 | 42375-1272 |
| 13 | 42375-1255 | 31 | 42375-1273 |
| 14 | 42375-1256 | 32 | 42375-1274 |
| 15 | 42375-1257 | 33 | 42375-1275 |
| 16 | 42375-1258 | 34 | 42375-1276 |
| 17 | 42375-1259 | 35 | 42375-1277 |
| 18 | 42375-1260 | 36 | 42375-1278 |
| 19 | 42375-1261 | | |

| | | | | | |
|-------------------------|------|------------------------------|--------------------|---|------------------|
| U | REV: | <u>ECR/ECN INFORMATION:</u> | <u>TITLE:</u> | KK 100 HEADER ASSY FLAT VERTICAL BREAKAWAY | <u>SHEET No.</u> |
| | | EC No.: UCP2017-2793 | | | - 14 - |
| | | DATE: 12/20/2021 | | | |
| <u>DOCUMENT NUMBER:</u> | | <u>CREATED / REVISED BY:</u> | <u>CHECKED BY:</u> | <u>APPROVED BY:</u> | |
| SD- 42375-001 | | SS06 | ISHWARG | ISHWARG | |

ENG. NO: 42375-1349/1382

| | |
|-------------------|--------------------|
| HEADER NUMBER: | 42312-0036 |
| PIN NUMBER: | 42663-ABA154 |
| PIN LENGTH: L | .455 / 11.56 |
| MATING LENGTH: M | .230 / 5.84 |
| GOLD POINT: G | N/A |
| PC TAIL LENGTH: P | .135 / 3.43 |
| TIN: T | OVERALL |
| CKTS: | 3-36 |
| KINKS: | SMES-42003 |
| VOIDED CKTS: | 2 |
| PACKAGING: | BULK PK-40873-0041 |

| CKTS | ITEM NUMBER | CKTS | ITEM NUMBER |
|------|-------------|------|-------------|
| 02 | | 20 | 42375-1366 |
| 03 | 42375-1349 | 21 | 42375-1367 |
| 04 | 42375-1350 | 22 | 42375-1368 |
| 05 | 42375-1351 | 23 | 42375-1369 |
| 06 | 42375-1352 | 24 | 42375-1370 |
| 07 | 42375-1353 | 25 | 42375-1371 |
| 08 | 42375-1354 | 26 | 42375-1372 |
| 09 | 42375-1355 | 27 | 42375-1373 |
| 10 | 42375-1356 | 28 | 42375-1374 |
| 11 | 42375-1357 | 29 | 42375-1375 |
| 12 | 42375-1358 | 30 | 42375-1376 |
| 13 | 42375-1359 | 31 | 42375-1377 |
| 14 | 42375-1360 | 32 | 42375-1378 |
| 15 | 42375-1361 | 33 | 42375-1379 |
| 16 | 42375-1362 | 34 | 42375-1380 |
| 17 | 42375-1363 | 35 | 42375-1381 |
| 18 | 42375-1364 | 36 | 42375-1382 |
| 19 | 42375-1365 | | |

ENG. NO: 42375-1515/1548

| | |
|-------------------|--------------------|
| HEADER NUMBER: | 42312-0036 |
| PIN NUMBER: | 42663-ABB208 |
| PIN LENGTH: L | .455 / 11.56 |
| MATING LENGTH: M | .230 / 5.84 |
| GOLD POINT: G | .140 / 3.56 |
| PC TAIL LENGTH: P | .135 / 3.43 |
| TIN: T | .100 / 2.54 |
| CKTS: | 3-36 |
| KINKS: | SMES-42003 |
| VOIDED CKTS: | 2 |
| PACKAGING: | BULK PK-40873-0041 |

| CKTS | ITEM NUMBER | CKTS | ITEM NUMBER |
|------|-------------|------|-------------|
| 02 | | 20 | 42375-1532 |
| 03 | 42375-1515 | 21 | 42375-1533 |
| 04 | 42375-1516 | 22 | 42375-1534 |
| 05 | 42375-1517 | 23 | 42375-1535 |
| 06 | 42375-1518 | 24 | 42375-1536 |
| 07 | 42375-1519 | 25 | 42375-1537 |
| 08 | 42375-1520 | 26 | 42375-1538 |
| 09 | 42375-1521 | 27 | 42375-1539 |
| 10 | 42375-1522 | 28 | 42375-1540 |
| 11 | 42375-1523 | 29 | 42375-1541 |
| 12 | 42375-1524 | 30 | 42375-1542 |
| 13 | 42375-1525 | 31 | 42375-1543 |
| 14 | 42375-1526 | 32 | 42375-1544 |
| 15 | 42375-1527 | 33 | 42375-1545 |
| 16 | 42375-1528 | 34 | 42375-1546 |
| 17 | 42375-1529 | 35 | 42375-1547 |
| 18 | 42375-1530 | 36 | 42375-1548 |
| 19 | 42375-1531 | | |

| | | | | | |
|-------------------------|------|------------------------------|--------------------|---|------------------|
| U | REV: | <u>ECR/ECN INFORMATION:</u> | <u>TITLE:</u> | KK 100 HEADER ASSY FLAT VERTICAL BREAKAWAY | <u>SHEET No.</u> |
| | | EC No.: UCP2017-2793 | | | - 15 - |
| | | DATE: 12/20/2021 | | | |
| <u>DOCUMENT NUMBER:</u> | | <u>CREATED / REVISED BY:</u> | <u>CHECKED BY:</u> | <u>APPROVED BY:</u> | |
| SD- 42375-001 | | SS06 | ISHWARG | ISHWARG | |

ENG. NO: 42375-1720/1753

| | | | |
|-------------------|--------------------|------|-------------|
| HEADER NUMBER: | 42312-0036 | | |
| PIN NUMBER: | 42663-ABB208 | | |
| PIN LENGTH: L | .455 / 11.56 | | |
| MATING LENGTH: M | .240 / 6.09 | | |
| GOLD POINT: G | .140 / 3.56 | | |
| PC TAIL LENGTH: P | .125 / 3.18 | | |
| TIN: T | .100 / 2.54 | | |
| CKTS: | 3-36 | | |
| KINKS: | NO | | |
| VOIDED CKTS: | 3 | | |
| PACKAGING: | BULK PK-40873-0041 | | |
| CKTS | ITEM NUMBER | CKTS | ITEM NUMBER |
| 02 | | 20 | 42375-1737 |
| 03 | 42375-1720 | 21 | 42375-1738 |
| 04 | 42375-1721 | 22 | 42375-1739 |
| 05 | 42375-1722 | 23 | 42375-1740 |
| 06 | 42375-1723 | 24 | 42375-1741 |
| 07 | 42375-1724 | 25 | 42375-1742 |
| 08 | 42375-1725 | 26 | 42375-1743 |
| 09 | 42375-1726 | 27 | 42375-1744 |
| 10 | 42375-1727 | 28 | 42375-1745 |
| 11 | 42375-1728 | 29 | 42375-1746 |
| 12 | 42375-1729 | 30 | 42375-1747 |
| 13 | 42375-1730 | 31 | 42375-1748 |
| 14 | 42375-1731 | 32 | 42375-1749 |
| 15 | 42375-1732 | 33 | 42375-1750 |
| 16 | 42375-1733 | 34 | 42375-1751 |
| 17 | 42375-1734 | 35 | 42375-1752 |
| 18 | 42375-1735 | 36 | 42375-1753 |
| 19 | 42375-1736 | | |

ENG. NO: 42375-1855/1889

| | | | |
|-------------------|--------------------|------|-------------|
| HEADER NUMBER: | 42312-0036 | | |
| PIN NUMBER: | 42663-CJA154 | | |
| PIN LENGTH: L | .700 / 17.78 | | |
| MATING LENGTH: M | .488 / 12.40 | | |
| GOLD POINT: G | N/A | | |
| PC TAIL LENGTH: P | .122 / 3.10 | | |
| TIN: T | OVERALL | | |
| CKTS: | 2-36 | | |
| KINKS: | NO | | |
| VOIDED CKTS: | NONE | | |
| PACKAGING: | BULK PK-40873-0041 | | |
| CKTS | ITEM NUMBER | CKTS | ITEM NUMBER |
| 02 | 42375-1855 | 20 | 42375-1873 |
| 03 | 42375-1856 | 21 | 42375-1874 |
| 04 | 42375-1857 | 22 | 42375-1875 |
| 05 | 42375-1858 | 23 | 42375-1876 |
| 06 | 42375-1859 | 24 | 42375-1877 |
| 07 | 42375-1860 | 25 | 42375-1878 |
| 08 | 42375-1861 | 26 | 42375-1879 |
| 09 | 42375-1862 | 27 | 42375-1880 |
| 10 | 42375-1863 | 28 | 42375-1881 |
| 11 | 42375-1864 | 29 | 42375-1882 |
| 12 | 42375-1865 | 30 | 42375-1883 |
| 13 | 42375-1866 | 31 | 42375-1884 |
| 14 | 42375-1867 | 32 | 42375-1885 |
| 15 | 42375-1868 | 33 | 42375-1886 |
| 16 | 42375-1869 | 34 | 42375-1887 |
| 17 | 42375-1870 | 35 | 42375-1888 |
| 18 | 42375-1871 | 36 | 42375-1889 |
| 19 | 42375-1872 | | |

REV:

UECR/ECN INFORMATION:EC No.: **UCP2017-2793**DATE: **12/20/2021**TITLE:**KK 100 HEADER ASSY
FLAT VERTICAL
BREAKAWAY**SHEET No.**- 16 -**DOCUMENT NUMBER:**SD- 42375-001**CREATED / REVISED BY:**SS06**CHECKED BY:**ISHWARG**APPROVED BY:**ISHWARG**

| | | | |
|--------------------------|-------------|--------------------|-------------|
| ENG. NO: 42375-1922/1956 | | | |
| HEADER NUMBER: | | 42312-0036 | |
| PIN NUMBER: | | 42663-AEA154 | |
| PIN LENGTH: L | | .470 / 11.94 | |
| MATING LENGTH: M | | .190 / 4.83 | |
| GOLD POINT: G | | N/A | |
| PC TAIL LENGTH: P | | .190 / 4.83 | |
| TIN: T | | .200 / 5.08 | |
| CKTS: | | 2-36 | |
| KINKS: | | NO | |
| VOIDED CKTS: | | NONE | |
| PACKAGING: | | BULK PK-40873-0041 | |
| CKTS | ITEM NUMBER | CKTS | ITEM NUMBER |
| 02 | 42375-1922 | 20 | 42375-1940 |
| 03 | 42375-1923 | 21 | 42375-1941 |
| 04 | 42375-1924 | 22 | 42375-1942 |
| 05 | 42375-1925 | 23 | 42375-1943 |
| 06 | 42375-1926 | 24 | 42375-1944 |
| 07 | 42375-1927 | 25 | 42375-1945 |
| 08 | 42375-1928 | 26 | 42375-1946 |
| 09 | 42375-1929 | 27 | 42375-1947 |
| 10 | 42375-1930 | 28 | 42375-1948 |
| 11 | 42375-1931 | 29 | 42375-1949 |
| 12 | 42375-1932 | 30 | 42375-1950 |
| 13 | 42375-1933 | 31 | 42375-1951 |
| 14 | 42375-1934 | 32 | 42375-1952 |
| 15 | 42375-1935 | 33 | 42375-1953 |
| 16 | 42375-1936 | 34 | 42375-1954 |
| 17 | 42375-1937 | 35 | 42375-1955 |
| 18 | 42375-1938 | 36 | 42375-1956 |
| 19 | 42375-1939 | | |

| | | | |
|--------------------------|-------------|--------------------|-------------|
| ENG. NO: 42375-2246/2275 | | | |
| HEADER NUMBER: | | 42312-0036 | |
| PIN NUMBER: | | 42663-ABA154 | |
| PIN LENGTH: L | | .455 / 11.56 | |
| MATING LENGTH: M | | .240 / 6.09 | |
| GOLD POINT: G | | N/A | |
| PC TAIL LENGTH: P | | .125 / 3.18 | |
| TIN: T | | OVERALL | |
| CKTS: | | 7-36 | |
| KINKS: | | NO | |
| VOIDED CKTS: | | 2,7 | |
| PACKAGING: | | BULK PK-40873-0041 | |
| CKTS | ITEM NUMBER | CKTS | ITEM NUMBER |
| 02 | | 20 | 42375-2259 |
| 03 | | 21 | 42375-2260 |
| 04 | | 22 | 42375-2261 |
| 05 | | 23 | 42375-2262 |
| 06 | | 24 | 42375-2263 |
| 07 | 42375-2246 | 25 | 42375-2264 |
| 08 | 42375-2247 | 26 | 42375-2265 |
| 09 | 42375-2248 | 27 | 42375-2266 |
| 10 | 42375-2249 | 28 | 42375-2267 |
| 11 | 42375-2250 | 29 | 42375-2268 |
| 12 | 42375-2251 | 30 | 42375-2269 |
| 13 | 42375-2252 | 31 | 42375-2270 |
| 14 | 42375-2253 | 32 | 42375-2271 |
| 15 | 42375-2254 | 33 | 42375-2272 |
| 16 | 42375-2255 | 34 | 42375-2273 |
| 17 | 42375-2256 | 35 | 42375-2274 |
| 18 | 42375-2257 | 36 | 42375-2275 |
| 19 | 42375-2258 | | |

| | | | |
|-------------------------|------------------------------|---|---------------------|
| REV: | <u>ECR/ECN INFORMATION:</u> | <u>TITLE:</u> | <u>SHEET No.</u> |
| U | EC No.: UCP2017-2793 | KK 100 HEADER ASSY FLAT VERTICAL BREAKAWAY | - 17 - |
| | DATE: 12/20/2021 | | |
| <u>DOCUMENT NUMBER:</u> | <u>CREATED / REVISED BY:</u> | <u>CHECKED BY:</u> | <u>APPROVED BY:</u> |
| SD- 42375-001 | SS06 | ISHWARG | ISHWARG |

| ENG. NO: 42375-2486/2520 | | | |
|--------------------------|-------------|--------------------|-------------|
| HEADER NUMBER: | | 42312-0036 | |
| PIN NUMBER: | | 42663-AFB208 | |
| PIN LENGTH: L | | .475 / 12.07 | |
| MATING LENGTH: M | | .232 / 5.89 | |
| GOLD POINT: G | | .150 / 3.81 | |
| PC TAIL LENGTH: P | | .153 / 3.89 | |
| TIN: T | | .100 / 2.54 | |
| CKTS: | | 2-36 | |
| KINKS: | | NO | |
| VOIDED CKTS: | | NONE | |
| PACKAGING: | | BULK PK-40873-0041 | |
| CKTS | ITEM NUMBER | CKTS | ITEM NUMBER |
| 02 | 42375-2486 | 19 | 42375-2503 |
| 03 | 42375-2487 | 20 | 42375-2504 |
| | 68300-2008 | 21 | 42375-2505 |
| 04 | 42375-2488 | 22 | 42375-2506 |
| 05 | 42375-2489 | 23 | 42375-2507 |
| 06 | 42375-2490 | 24 | 42375-2508 |
| 07 | 42375-2491 | 25 | 42375-2509 |
| 08 | 42375-2492 | 26 | 42375-2510 |
| 09 | 42375-2493 | 27 | 42375-2511 |
| 10 | 42375-2494 | 28 | 42375-2512 |
| 11 | 42375-2495 | 29 | 42375-2513 |
| 12 | 42375-2496 | 30 | 42375-2514 |
| 13 | 42375-2497 | 31 | 42375-2515 |
| 14 | 42375-2498 | 32 | 42375-2516 |
| 15 | 42375-2499 | 33 | 42375-2517 |
| 16 | 42375-2500 | 34 | 42375-2518 |
| 17 | 42375-2501 | 35 | 42375-2519 |
| 18 | 42375-2502 | 36 | 42375-2520 |

| ENG. NO: 42375-2521/2555 | | | |
|--------------------------|-------------|--------------------|-------------|
| HEADER NUMBER: | | 42312-0036 | |
| PIN NUMBER: | | 42663-AFB228 | |
| PIN LENGTH: L | | .475 / 12.07 | |
| MATING LENGTH: M | | .232 / 5.89 | |
| GOLD POINT: G | | .150 / 3.81 | |
| PC TAIL LENGTH: P | | .153 / 3.89 | |
| TIN: T | | .100 / 2.54 | |
| CKTS: | | 2-36 | |
| KINKS: | | NO | |
| VOIDED CKTS: | | NONE | |
| PACKAGING: | | BULK PK-40873-0041 | |
| CKTS | ITEM NUMBER | CKTS | ITEM NUMBER |
| 02 | 42375-2521 | 20 | 42375-2539 |
| 03 | 42375-2522 | 21 | 42375-2540 |
| 04 | 42375-2523 | 22 | 42375-2541 |
| 05 | 42375-2524 | 23 | 42375-2542 |
| 06 | 42375-2525 | 24 | 42375-2543 |
| 07 | 42375-2526 | 25 | 42375-2544 |
| 08 | 42375-2527 | 26 | 42375-2545 |
| 09 | 42375-2528 | 27 | 42375-2546 |
| 10 | 42375-2529 | 28 | 42375-2547 |
| 11 | 42375-2530 | 29 | 42375-2548 |
| 12 | 42375-2531 | 30 | 42375-2549 |
| 13 | 42375-2532 | 31 | 42375-2550 |
| 14 | 42375-2533 | 32 | 42375-2551 |
| 15 | 42375-2534 | 33 | 42375-2552 |
| 16 | 42375-2535 | 34 | 42375-2553 |
| 17 | 42375-2536 | 35 | 42375-2554 |
| 18 | 42375-2537 | 36 | 42375-2555 |
| 19 | 42375-2538 | | |

| | | | | |
|----------------------|------|-----------------------------|---|----------------|
| U | REV: | ECR/ECN INFORMATION: | TITLE: | SHEET No. |
| | | EC No.: UCP2017-2793 | KK 100 HEADER ASSY FLAT VERTICAL BREAKAWAY | - 18 - |
| | | DATE: 12/20/2021 | | |
| DOCUMENT NUMBER: | | CREATED / REVISED BY: | CHECKED BY: | APPROVED BY: |
| SD- 42375-001 | | SS06 | ISHWARG | ISHWARG |

| | | | |
|--------------------------|-------------|--------------------|-------------|
| ENG. NO: 42375-2801/2835 | | | |
| HEADER NUMBER: | | 42312-0036 | |
| PIN NUMBER: | | 42663-HDB228 | |
| PIN LENGTH: L | | 1.200 / 30.48 | |
| MATING LENGTH: M | | 1.000 / 25.40 | |
| GOLD POINT: G | | .200 / 5.08 | |
| PC TAIL LENGTH: P | | .110 / 2.79 | |
| TIN: T | | .200 / 5.08 | |
| CKTS: | | 2-36 | |
| KINKS: | | NO | |
| VOIDED CKTS: | | NONE | |
| PACKAGING: | | BULK PK-40873-0043 | |
| CKTS | ITEM NUMBER | CKTS | ITEM NUMBER |
| 02 | 42375-2801 | 20 | 42375-2819 |
| 03 | 42375-2802 | 21 | 42375-2820 |
| 04 | 42375-2803 | 22 | 42375-2821 |
| 05 | 42375-2804 | 23 | 42375-2822 |
| 06 | 42375-2805 | 24 | 42375-2823 |
| 07 | 42375-2806 | 25 | 42375-2824 |
| 08 | 42375-2807 | 26 | 42375-2825 |
| 09 | 42375-2808 | 27 | 42375-2826 |
| 10 | 42375-2809 | 28 | 42375-2827 |
| 11 | 42375-2810 | 29 | 42375-2828 |
| 12 | 42375-2811 | 30 | 42375-2829 |
| 13 | 42375-2812 | 31 | 42375-2830 |
| 14 | 42375-2813 | 32 | 42375-2831 |
| 15 | 42375-2814 | 33 | 42375-2832 |
| 16 | 42375-2815 | 34 | 42375-2833 |
| 17 | 42375-2816 | 35 | 42375-2834 |
| 18 | 42375-2817 | 36 | 42375-2835 |
| 19 | 42375-2818 | | |

| | | | |
|--------------------------|-------------|--------------------|-------------|
| ENG. NO: 42375-2836/2870 | | | |
| HEADER NUMBER: | | 42312-0036 | |
| PIN NUMBER: | | 42663-EMA154 | |
| PIN LENGTH: L | | .925 / 23.50 | |
| MATING LENGTH: M | | .625 / 15.88 | |
| GOLD POINT: G | | N/A | |
| PC TAIL LENGTH: P | | .210 / 5.33 | |
| TIN: T | | OVERALL | |
| CKTS: | | 2-36 | |
| KINKS: | | NO | |
| VOIDED CKTS: | | NONE | |
| PACKAGING: | | BULK PK-40873-0041 | |
| CKTS | ITEM NUMBER | CKTS | ITEM NUMBER |
| 02 | 42375-2836 | 20 | 42375-2854 |
| 03 | 42375-2837 | 21 | 42375-2855 |
| 04 | 42375-2838 | 22 | 42375-2856 |
| 05 | 42375-2839 | 23 | 42375-2857 |
| 06 | 42375-2840 | 24 | 42375-2858 |
| 07 | 42375-2841 | 25 | 42375-2859 |
| 08 | 42375-2842 | 26 | 42375-2860 |
| 09 | 42375-2843 | 27 | 42375-2861 |
| 10 | 42375-2844 | 28 | 42375-2862 |
| 11 | 42375-2845 | 29 | 42375-2863 |
| 12 | 42375-2846 | 30 | 42375-2864 |
| 13 | 42375-2847 | 31 | 42375-2865 |
| 14 | 42375-2848 | 32 | 42375-2866 |
| 15 | 42375-2849 | 33 | 42375-2867 |
| 16 | 42375-2850 | 34 | 42375-2868 |
| 17 | 42375-2851 | 35 | 42375-2869 |
| 18 | 42375-2852 | 36 | 42375-2870 |
| 19 | 42375-2853 | | |

| | | | | | |
|----------------------|------|-----------------------------|----------------|---|---------------|
| U | REV: | ECR/ECN INFORMATION: | TITLE: | KK 100 HEADER ASSY FLAT VERTICAL BREAKAWAY | SHEET No. |
| | | EC No.: UCP2017-2793 | | | - 19 - |
| | | DATE: 12/20/2021 | | | |
| DOCUMENT NUMBER: | | CREATED / REVISED BY: | CHECKED BY: | APPROVED BY: | |
| SD- 42375-001 | | SS06 | ISHWARG | ISHWARG | |

ENG. NO: 42375-3044/3078

| | |
|-------------------|--------------------|
| HEADER NUMBER: | 42312-0036 |
| PIN NUMBER: | 42663-KHB208 |
| PIN LENGTH: L | 1.430 / 36.32 |
| MATING LENGTH: M | .867 / 22.02 |
| GOLD POINT: G | .200 / 5.08 |
| PC TAIL LENGTH: P | .473 / 12.01 |
| TIN: T | .200 / 5.08 |
| CKTS: | 2-36 |
| KINKS: | NO |
| VOIDED CKTS: | NONE |
| PACKAGING: | BULK PK-40873-0043 |

| CKTS | ITEM NUMBER | CKTS | ITEM NUMBER |
|------|-------------|------|-------------|
| 02 | 42375-3044 | 20 | 42375-3062 |
| 03 | 42375-3045 | 21 | 42375-3063 |
| 04 | 42375-3046 | 22 | 42375-3064 |
| 05 | 42375-3047 | 23 | 42375-3065 |
| 06 | 42375-3048 | 24 | 42375-3066 |
| 07 | 42375-3049 | 25 | 42375-3067 |
| 08 | 42375-3050 | 26 | 42375-3068 |
| 09 | 42375-3051 | 27 | 42375-3069 |
| 10 | 42375-3052 | 28 | 42375-3070 |
| 11 | 42375-3053 | 29 | 42375-3071 |
| 12 | 42375-3054 | 30 | 42375-3072 |
| 13 | 42375-3055 | 31 | 42375-3073 |
| 14 | 42375-3056 | 32 | 42375-3074 |
| 15 | 42375-3057 | 33 | 42375-3075 |
| 16 | 42375-3058 | 34 | 42375-3076 |
| 17 | 42375-3059 | 35 | 42375-3077 |
| 18 | 42375-3060 | 36 | 42375-3078 |
| 19 | 42375-3061 | | |

ENG. NO: 42375-3114/3148

| | |
|-------------------|--------------------|
| HEADER NUMBER: | 42312-0036 |
| PIN NUMBER: | 42663-BXA154 |
| PIN LENGTH: L | .645 / 16.38 |
| MATING LENGTH: M | .431 / 10.95 |
| GOLD POINT: G | N/A |
| PC TAIL LENGTH: P | .124 / 3.15 |
| TIN: T | OVERALL |
| CKTS: | 2-36 |
| KINKS: | NO |
| VOIDED CKTS: | NONE |
| PACKAGING: | BULK PK-40873-0041 |

| CKTS | ITEM NUMBER | CKTS | ITEM NUMBER |
|------|-------------|------|-------------|
| 02 | 42375-3114 | 20 | 42375-3132 |
| 03 | 42375-3115 | 21 | 42375-3133 |
| 04 | 42375-3116 | 22 | 42375-3134 |
| 05 | 42375-3117 | 23 | 42375-3135 |
| 06 | 42375-3118 | 24 | 42375-3136 |
| 07 | 42375-3119 | 25 | 42375-3137 |
| 08 | 42375-3120 | 26 | 42375-3138 |
| 09 | 42375-3121 | 27 | 42375-3139 |
| 10 | 42375-3122 | 28 | 42375-3140 |
| 11 | 42375-3123 | 29 | 42375-3141 |
| 12 | 42375-3124 | 30 | 42375-3142 |
| 13 | 42375-3125 | 31 | 42375-3143 |
| 14 | 42375-3126 | 32 | 42375-3144 |
| 15 | 42375-3127 | 33 | 42375-3145 |
| 16 | 42375-3128 | 34 | 42375-3146 |
| 17 | 42375-3129 | 35 | 42375-3147 |
| 18 | 42375-3130 | 36 | 42375-3148 |
| 19 | 42375-3131 | | |

REV:

UECR/ECN INFORMATION:EC No.: **UCP2017-2793**DATE: **12/20/2021**TITLE:

**KK 100 HEADER ASSY
FLAT VERTICAL
BREAKAWAY**

SHEET No.**- 20 -**DOCUMENT NUMBER:**SD- 42375-001**CREATED / REVISED BY:**SS06**CHECKED BY:**ISHWARG**APPROVED BY:**ISHWARG**

| | |
|----------------------------|--------------------|
| ENG. NO: 42375-3149 / 3183 | |
| HEADER NUMBER: | 42312-0036 |
| PIN NUMBER: | 42663-BEB208 |
| PIN LENGTH: L | .575 / 14.61 |
| MATING LENGTH: M | .350 / 8.89 |
| GOLD POINT: G | .200 / 5.08 |
| PC TAIL LENGTH: P | .135 / 3.43 |
| TIN: T | .200 / 5.08 |
| CKTS: | 2-36 |
| KINKS: | NO |
| VOIDED CKTS: | NONE |
| PACKAGING: | BULK PK-40873-0041 |

| CKTS | ITEM NUMBER | CKTS | ITEM NUMBER |
|------|-------------|------|-------------|
| 02 | 42375-3149 | 20 | 42375-3167 |
| 03 | 42375-3150 | 21 | 42375-3168 |
| 04 | 42375-3151 | 22 | 42375-3169 |
| 05 | 42375-3152 | 23 | 42375-3170 |
| 06 | 42375-3153 | 24 | 42375-3171 |
| 07 | 42375-3154 | 25 | 42375-3172 |
| 08 | 42375-3155 | 26 | 42375-3173 |
| 09 | 42375-3156 | 27 | 42375-3174 |
| 10 | 42375-3157 | 28 | 42375-3175 |
| 11 | 42375-3158 | 29 | 42375-3176 |
| 12 | 42375-3159 | 30 | 42375-3177 |
| 13 | 42375-3160 | 31 | 42375-3178 |
| 14 | 42375-3161 | 32 | 42375-3179 |
| 15 | 42375-3162 | 33 | 42375-3180 |
| 16 | 42375-3163 | 34 | 42375-3181 |
| 17 | 42375-3164 | 35 | 42375-3182 |
| 18 | 42375-3165 | 36 | 42375-3183 |
| 19 | 42375-3166 | | |

| | |
|----------------------------|--------------------|
| ENG. NO: 42375-3184 / 3218 | |
| HEADER NUMBER: | 42312-0036 |
| PIN NUMBER: | 42663-GNB208 |
| PIN LENGTH: L | 1.140 / 28.96 |
| MATING LENGTH: M | .913 / 23.20 |
| GOLD POINT: G | .200 / 5.08 |
| PC TAIL LENGTH: P | .137 / 3.48 |
| TIN: T | .200 / 5.08 |
| CKTS: | 2-36 |
| KINKS: | NO |
| VOIDED CKTS: | NONE |
| PACKAGING: | BULK PK-40873-0043 |

| CKTS | ITEM NUMBER | CKTS | ITEM NUMBER |
|------|-------------|------|-------------|
| 02 | 42375-3184 | 20 | 42375-3202 |
| 03 | 42375-3185 | 21 | 42375-3203 |
| 04 | 42375-3186 | 22 | 42375-3204 |
| 05 | 42375-3187 | 23 | 42375-3205 |
| 06 | 42375-3188 | 24 | 42375-3206 |
| 07 | 42375-3189 | 25 | 42375-3207 |
| 08 | 42375-3190 | 26 | 42375-3208 |
| 09 | 42375-3191 | 27 | 42375-3209 |
| 10 | 42375-3192 | 28 | 42375-3210 |
| 11 | 42375-3193 | 29 | 42375-3211 |
| 12 | 42375-3194 | 30 | 42375-3212 |
| 13 | 42375-3195 | 31 | 42375-3213 |
| 14 | 42375-3196 | 32 | 42375-3214 |
| 15 | 42375-3197 | 33 | 42375-3215 |
| 16 | 42375-3198 | 34 | 42375-3216 |
| 17 | 42375-3199 | 35 | 42375-3217 |
| 18 | 42375-3200 | 36 | 42375-3218 |
| 19 | 42375-3201 | | |

| | |
|----------------------------|--------------------|
| ENG. NO: 42375-3219 / 3253 | |
| HEADER NUMBER: | 42312-0036 |
| PIN NUMBER: | 42663-BPA154 |
| PIN LENGTH: L | .620 / 15.75 |
| MATING LENGTH: M | .280 / 7.11 |
| GOLD POINT: G | NA |
| PC TAIL LENGTH: P | .250 / 6.35 |
| TIN: T | OVERALL |
| CKTS: | 2-36 |
| KINKS: | NO |
| VOIDED CKTS: | NONE |
| PACKAGING: | BULK PK-40873-0041 |

| CKTS | ITEM NUMBER | CKTS | ITEM NUMBER |
|------|-------------|------|-------------|
| 02 | 42375-3219 | 20 | 42375-3237 |
| 03 | 42375-3220 | 21 | 42375-3238 |
| 04 | 42375-3221 | 22 | 42375-3239 |
| 05 | 42375-3222 | 23 | 42375-3240 |
| 06 | 42375-3223 | 24 | 42375-3241 |
| 07 | 42375-3224 | 25 | 42375-3242 |
| 08 | 42375-3225 | 26 | 42375-3243 |
| 09 | 42375-3226 | 27 | 42375-3244 |
| 10 | 42375-3227 | 28 | 42375-3245 |
| 11 | 42375-3228 | 29 | 42375-3246 |
| 12 | 42375-3229 | 30 | 42375-3247 |
| 13 | 42375-3230 | 31 | 42375-3248 |
| 14 | 42375-3231 | 32 | 42375-3249 |
| 15 | 42375-3232 | 33 | 42375-3250 |
| 16 | 42375-3233 | 34 | 42375-3251 |
| 17 | 42375-3234 | 35 | 42375-3252 |
| 18 | 42375-3235 | 36 | 42375-3253 |
| 19 | 42375-3236 | | |

| | | | | |
|----------------------|------|-----------------------------|---|----------------|
| U | REV: | ECR/ECN INFORMATION: | TITLE: | SHEET No. |
| | | EC No.: UCP2017-2793 | KK 100 HEADER ASSY FLAT VERTICAL BREAKAWAY | - 21 - |
| | | DATE: 12/20/2021 | | |
| DOCUMENT NUMBER: | | CREATED / REVISED BY: | CHECKED BY: | APPROVED BY: |
| SD- 42375-001 | | SS06 | ISHWARG | ISHWARG |

| ENG. NO: 42375-3254 / 3288 | | | |
|----------------------------|-------------|--------------------|-------------|
| HEADER NUMBER: | | 42312-0036 | |
| PIN NUMBER: | | 42663-DMA154 | |
| PIN LENGTH: L | | .820 / 20.83 | |
| MATING LENGTH: M | | .590 / 14.99 | |
| GOLD POINT: G | | NA | |
| PC TAIL LENGTH: P | | .140 / 3.56 | |
| TIN: T | | OVERALL | |
| CKTS: | | 2-36 | |
| KINKS: | | NO | |
| VOIDED CKTS: | | NONE | |
| PACKAGING: | | BULK PK-40873-0041 | |
| CKTS | ITEM NUMBER | CKTS | ITEM NUMBER |
| 02 | 42375-3254 | 20 | 42375-3272 |
| 03 | 42375-3255 | 21 | 42375-3273 |
| 04 | 42375-3256 | 22 | 42375-3274 |
| 05 | 42375-3257 | 23 | 42375-3275 |
| 06 | 42375-3258 | 24 | 42375-3276 |
| 07 | 42375-3259 | 25 | 42375-3277 |
| 08 | 42375-3260 | 26 | 42375-3278 |
| 09 | 42375-3261 | 27 | 42375-3279 |
| 10 | 42375-3262 | 28 | 42375-3280 |
| 11 | 42375-3263 | 29 | 42375-3281 |
| 12 | 42375-3264 | 30 | 42375-3282 |
| 13 | 42375-3265 | 31 | 42375-3283 |
| 14 | 42375-3266 | 32 | 42375-3284 |
| 15 | 42375-3267 | 33 | 42375-3285 |
| 16 | 42375-3268 | 34 | 42375-3286 |
| 17 | 42375-3269 | 35 | 42375-3287 |
| 18 | 42375-3270 | 36 | 42375-3288 |
| 19 | 42375-3271 | | |

| ENG. NO: 42375-3289 / 3323 | | | |
|----------------------------|-------------|--------------------|-------------|
| HEADER NUMBER: | | 42312-0036 | |
| PIN NUMBER: | | 42663-FNA154 | |
| PIN LENGTH: L | | 1.035 / 26.29 | |
| MATING LENGTH: M | | .358 / 9.09 | |
| GOLD POINT: G | | NA | |
| PC TAIL LENGTH: P | | .587 / 14.91 | |
| TIN: T | | OVERALL | |
| CKTS: | | 2-36 | |
| KINKS: | | NO | |
| VOIDED CKTS: | | NONE | |
| PACKAGING: | | BULK PK-40873-0043 | |
| CKTS | ITEM NUMBER | CKTS | ITEM NUMBER |
| 02 | 42375-3289 | 20 | 42375-3307 |
| 03 | 42375-3290 | 21 | 42375-3308 |
| 04 | 42375-3291 | 22 | 42375-3309 |
| 05 | 42375-3292 | 23 | 42375-3310 |
| 06 | 42375-3293 | 24 | 42375-3311 |
| 07 | 42375-3294 | 25 | 42375-3312 |
| 08 | 42375-3295 | 26 | 42375-3313 |
| 09 | 42375-3296 | 27 | 42375-3314 |
| 10 | 42375-3297 | 28 | 42375-3315 |
| 11 | 42375-3298 | 29 | 42375-3316 |
| 12 | 42375-3299 | 30 | 42375-3317 |
| 13 | 42375-3300 | 31 | 42375-3318 |
| 14 | 42375-3301 | 32 | 42375-3319 |
| 15 | 42375-3302 | 33 | 42375-3320 |
| 16 | 42375-3303 | 34 | 42375-3321 |
| 17 | 42375-3304 | 35 | 42375-3322 |
| 18 | 42375-3305 | 36 | 42375-3323 |
| 19 | 42375-3306 | | |

| ENG. NO: 42375-3324 / 3358 | | | |
|----------------------------|-------------|--------------------|-------------|
| HEADER NUMBER: | | 42312-0036 | |
| PIN NUMBER: | | 42663-CCA154 | |
| PIN LENGTH: L | | .670 / 17.02 | |
| MATING LENGTH: M | | .440 / 11.18 | |
| GOLD POINT: G | | NA | |
| PC TAIL LENGTH: P | | .140 / 3.56 | |
| TIN: T | | OVERALL | |
| CKTS: | | 2-36 | |
| KINKS: | | SMES-42003 | |
| VOIDED CKTS: | | NONE | |
| PACKAGING: | | BULK PK-40873-0041 | |
| CKTS | ITEM NUMBER | CKTS | ITEM NUMBER |
| 02 | 42375-3324 | 20 | 42375-3342 |
| 03 | 42375-3325 | 21 | 42375-3343 |
| 04 | 42375-3326 | 22 | 42375-3344 |
| 05 | 42375-3327 | 23 | 42375-3345 |
| 06 | 42375-3328 | 24 | 42375-3346 |
| 07 | 42375-3329 | 25 | 42375-3347 |
| 08 | 42375-3330 | 26 | 42375-3348 |
| 09 | 42375-3331 | 27 | 42375-3349 |
| 10 | 42375-3332 | 28 | 42375-3350 |
| 11 | 42375-3333 | 29 | 42375-3351 |
| 12 | 42375-3334 | 30 | 42375-3352 |
| 13 | 42375-3335 | 31 | 42375-3353 |
| 14 | 42375-3336 | 32 | 42375-3354 |
| 15 | 42375-3337 | 33 | 42375-3355 |
| 16 | 42375-3338 | 34 | 42375-3356 |
| 17 | 42375-3339 | 35 | 42375-3357 |
| 18 | 42375-3340 | 36 | 42375-3358 |
| 19 | 42375-3341 | | |

| | | | | | |
|-------------------------|------|------------------------------|--------------------|---|------------------|
| U | REV: | <u>ECR/ECN INFORMATION:</u> | <u>TITLE:</u> | KK 100 HEADER ASSY FLAT VERTICAL BREAKAWAY | <u>SHEET No.</u> |
| | | EC No.: UCP2017-2793 | | | - 22 - |
| | | DATE: 12/20/2021 | | | |
| <u>DOCUMENT NUMBER:</u> | | <u>CREATED / REVISED BY:</u> | <u>CHECKED BY:</u> | <u>APPROVED BY:</u> | |
| SD- 42375-001 | | SS06 | ISHWARG | ISHWARG | |

| ENG. NO: 42375-3359 / 3393 | | | |
|----------------------------|-------------|--------------------|-------------|
| HEADER NUMBER: | | 42312-0036 | |
| PIN NUMBER: | | 42663-ABB228 | |
| PIN LENGTH: L | | .455 / 11.56 | |
| MATING LENGTH: M | | .170 / 4.32 | |
| GOLD POINT: G | | .100 / 2.54 | |
| PC TAIL LENGTH: P | | .195 / 4.95 | |
| TIN: T | | .100 / 2.54 | |
| CKTS: | | 2-36 | |
| KINKS: | | NO | |
| VOIDED CKTS: | | NONE | |
| PACKAGING: | | BULK PK-40873-0041 | |
| CKTS | ITEM NUMBER | CKTS | ITEM NUMBER |
| 02 | 42375-3359 | 20 | 42375-3377 |
| 03 | 42375-3360 | 21 | 42375-3378 |
| 04 | 42375-3361 | 22 | 42375-3379 |
| 05 | 42375-3362 | 23 | 42375-3380 |
| 06 | 42375-3363 | 24 | 42375-3381 |
| 07 | 42375-3364 | 25 | 42375-3382 |
| 08 | 42375-3365 | 26 | 42375-3383 |
| 09 | 42375-3366 | 27 | 42375-3384 |
| 10 | 42375-3367 | 28 | 42375-3385 |
| 11 | 42375-3368 | 29 | 42375-3386 |
| 12 | 42375-3369 | 30 | 42375-3387 |
| 13 | 42375-3370 | 31 | 42375-3388 |
| 14 | 42375-3371 | 32 | 42375-3389 |
| 15 | 42375-3372 | 33 | 42375-3390 |
| 16 | 42375-3373 | 34 | 42375-3391 |
| 17 | 42375-3374 | 35 | 42375-3392 |
| 18 | 42375-3375 | 36 | 42375-3393 |
| 19 | 42375-3376 | | |

| ENG. NO: 42375-3394 / 3428 | | | |
|----------------------------|-------------|--------------------|-------------|
| HEADER NUMBER: | | 42312-0036 | |
| PIN NUMBER: | | 42663-EZB208 | |
| PIN LENGTH: L | | .970/24.64 | |
| MATING LENGTH: M | | .780/19.81 | |
| GOLD POINT: G | | .200/5.08 | |
| PC TAIL LENGTH: P | | .100/ 2.54 | |
| TIN: T | | .200/5.08 | |
| CKTS: | | 2-36 | |
| KINKS: | | NO | |
| VOIDED CKTS: | | NONE | |
| PACKAGING: | | BULK PK-40873-0043 | |
| CKTS | ITEM NUMBER | CKTS | ITEM NUMBER |
| 02 | 42375-3394 | 20 | 42375-3412 |
| 03 | 42375-3395 | 21 | 42375-3413 |
| 04 | 42375-3396 | 22 | 42375-3414 |
| 05 | 42375-3397 | 23 | 42375-3415 |
| 06 | 42375-3398 | 24 | 42375-3416 |
| 07 | 42375-3399 | 25 | 42375-3417 |
| 08 | 42375-3400 | 26 | 42375-3418 |
| 09 | 42375-3401 | 27 | 42375-3419 |
| 10 | 42375-3402 | 28 | 42375-3420 |
| 11 | 42375-3403 | 29 | 42375-3421 |
| 12 | 42375-3404 | 30 | 42375-3422 |
| 13 | 42375-3405 | 31 | 42375-3423 |
| 14 | 42375-3406 | 32 | 42375-3424 |
| 15 | 42375-3407 | 33 | 42375-3425 |
| 16 | 42375-3408 | 34 | 42374-3426 |
| 17 | 42375-3409 | 35 | 42375-3427 |
| 18 | 42375-3410 | 36 | 42375-3428 |
| 19 | 42375-3411 | | |

| ENG. NO: 42375-3429 / 3463 | | | |
|----------------------------|-------------|--------------------|-------------|
| HEADER NUMBER: | | 42312-0036 | |
| PIN NUMBER: | | 42663-ARA154 | |
| PIN LENGTH: L | | .520/13.21 | |
| MATING LENGTH: M | | .386/9.80 | |
| GOLD POINT: G | | N/A | |
| PC TAIL LENGTH: P | | .044/1.12 | |
| TIN: T | | OVERALL | |
| CKTS: | | 2-36 | |
| KINKS: | | NO | |
| VOIDED CKTS: | | NONE | |
| PACKAGING: | | BULK PK-40873-0041 | |
| CKTS | ITEM NUMBER | CKTS | ITEM NUMBER |
| 02 | 42375-3429 | 20 | 42375-3447 |
| 03 | 42375-3430 | 21 | 42375-3448 |
| 04 | 42375-3431 | 22 | 42375-3449 |
| 05 | 42375-3432 | 23 | 42375-3450 |
| 06 | 42375-3433 | 24 | 42375-3451 |
| 07 | 42375-3434 | 25 | 42375-3452 |
| 08 | 42375-3435 | 26 | 42375-3453 |
| 09 | 42375-3436 | 27 | 42375-3454 |
| 10 | 42375-3437 | 28 | 42375-3455 |
| 11 | 42375-3438 | 29 | 42375-3456 |
| 12 | 42375-3439 | 30 | 42375-3457 |
| 13 | 42375-3440 | 31 | 42375-3458 |
| 14 | 42375-3441 | 32 | 42375-3459 |
| 15 | 42375-3442 | 33 | 42375-3460 |
| 16 | 42375-3443 | 34 | 42374-3461 |
| 17 | 42375-3444 | 35 | 42375-3462 |
| 18 | 42375-3445 | 36 | 42375-3463 |
| 19 | 42375-3446 | | |

| | | | | |
|---|------|---|---|---------------------------------------|
| U | REV: | <u>ECR/ECN INFORMATION:</u> | <u>TITLE:</u> | <u>SHEET No.</u> |
| | | EC No.: UCP2017-2793 | KK 100 HEADER ASSY FLAT VERTICAL BREAKAWAY | - 23 - |
| | | DATE: 12/20/2021 | | |
| <u>DOCUMENT NUMBER:</u> SD- 42375-001 | | <u>CREATED / REVISED BY:</u> SS06 | <u>CHECKED BY:</u> ISHWARG | <u>APPROVED BY:</u> ISHWARG |

| ENG. NO: 42375-3464 / 3498 | | | |
|----------------------------|-------------|--------------------|-------------|
| HEADER NUMBER: | | 42312-0036 | |
| PIN NUMBER: | | 42663-CJA154 | |
| PIN LENGTH: L | | .700/17.78 | |
| MATING LENGTH: M | | .500/12.70 | |
| GOLD POINT: G | | N/A | |
| PC TAIL LENGTH: P | | .110/2.79 | |
| TIN: T | | OVERALL | |
| CKTS: | | 2-36 | |
| KINKS: | | NO | |
| VOIDED CKTS: | | # 2 | |
| PACKAGING: | | BULK PK-40873-0041 | |
| CKTS | ITEM NUMBER | CKTS | ITEM NUMBER |
| 02 | 42375-3464 | 20 | 42375-3482 |
| 03 | 42375-3465 | 21 | 42375-3483 |
| 04 | 42375-3466 | 22 | 42375-3484 |
| 05 | 42375-3467 | 23 | 42375-3485 |
| 06 | 42375-3468 | 24 | 42375-3486 |
| 07 | 42375-3469 | 25 | 42375-3487 |
| 08 | 42375-3470 | 26 | 42375-3488 |
| 09 | 42375-3471 | 27 | 42375-3489 |
| 10 | 42375-3472 | 28 | 42375-3490 |
| 11 | 42375-3473 | 29 | 42375-3491 |
| 12 | 42375-3474 | 30 | 42375-3492 |
| 13 | 42375-3475 | 31 | 42375-3493 |
| 14 | 42375-3476 | 32 | 42375-3494 |
| 15 | 42375-3477 | 33 | 42375-3495 |
| 16 | 42375-3478 | 34 | 42375-3496 |
| 17 | 42375-3479 | 35 | 42375-3497 |
| 18 | 42375-3480 | 36 | 42375-3498 |
| 19 | 42375-3481 | | |

| ENG. NO: 42375-3499/3533 | | | |
|--------------------------|-------------|--------------------|-------------|
| HEADER NUMBER: | | 42312-0036 | |
| PIN NUMBER: | | 42663-ETA154 | |
| PIN LENGTH: L | | .950/24.13 | |
| MATING LENGTH: M | | .750/19.05 | |
| GOLD POINT: G | | N/A | |
| PC TAIL LENGTH: P | | .110/2.79 | |
| TIN: T | | OVERALL | |
| CKTS: | | 2-36 | |
| KINKS: | | NO | |
| VOIDED CKTS: | | NONE | |
| PACKAGING: | | BULK PK-40873-0043 | |
| CKTS | ITEM NUMBER | CKTS | ITEM NUMBER |
| 02 | 42375-3499 | 20 | 42375-3517 |
| 03 | 42375-3500 | 21 | 42375-3518 |
| 04 | 42375-3501 | 22 | 42375-3519 |
| 05 | 42375-3502 | 23 | 42375-3520 |
| 06 | 42375-3503 | 24 | 42375-3521 |
| 07 | 42375-3504 | 25 | 42375-3522 |
| 08 | 42375-3505 | 26 | 42375-3523 |
| 09 | 42375-3506 | 27 | 42375-3524 |
| 10 | 42375-3507 | 28 | 42375-3525 |
| 11 | 42375-3508 | 29 | 42375-3526 |
| 12 | 42375-3509 | 30 | 42375-3527 |
| 13 | 42375-3510 | 31 | 42375-3528 |
| 14 | 42375-3511 | 32 | 42375-3529 |
| 15 | 42375-3512 | 33 | 42375-3530 |
| 16 | 42375-3513 | 34 | 42375-3531 |
| 17 | 42375-3514 | 35 | 42375-3532 |
| 18 | 42375-3515 | 36 | 42375-3533 |
| 19 | 42375-3516 | | |

| ENG. NO: 42375-3534/3568 | | | |
|--------------------------|-------------|--------------------|-------------|
| HEADER NUMBER: | | 42312-0036 | |
| PIN NUMBER: | | 42663-AWB208 | |
| PIN LENGTH: L | | .535/13.59 | |
| MATING LENGTH: M | | .235/5.97 | |
| GOLD POINT: G | | .200/5.08 | |
| PC TAIL LENGTH: P | | .210/5.33 | |
| TIN: T | | .100/2.54 | |
| CKTS: | | 2-36 | |
| KINKS: | | NO | |
| VOIDED CKTS: | | NONE | |
| PACKAGING: | | BULK PK-40873-0041 | |
| CKTS | ITEM NUMBER | CKTS | ITEM NUMBER |
| 02 | 42375-3534 | 20 | 42375-3552 |
| 03 | 42375-3535 | 21 | 42375-3553 |
| 04 | 42375-3536 | 22 | 42375-3554 |
| 05 | 42375-3537 | 23 | 42375-3555 |
| 06 | 42375-3538 | 24 | 42375-3556 |
| 07 | 42375-3539 | 25 | 42375-3557 |
| 08 | 42375-3540 | 26 | 42375-3558 |
| 09 | 42375-3541 | 27 | 42375-3559 |
| 10 | 42375-3542 | 28 | 42375-3560 |
| 11 | 42375-3543 | 29 | 42375-3561 |
| 12 | 42375-3544 | 30 | 42375-3562 |
| 13 | 42375-3545 | 31 | 42375-3563 |
| 14 | 42375-3546 | 32 | 42375-3564 |
| 15 | 42375-3547 | 33 | 42375-3565 |
| 16 | 42375-3548 | 34 | 42375-3566 |
| 17 | 42375-3549 | 35 | 42375-3567 |
| 18 | 42375-3550 | 36 | 42375-3568 |
| 19 | 42375-3551 | | |

| | | | | |
|---|------|---|---|---------------------------------------|
| U | REV: | <u>ECR/ECN INFORMATION:</u> | <u>TITLE:</u> | <u>SHEET No.</u> |
| | | EC No.: UCP2017-2793 | KK 100 HEADER ASSY FLAT VERTICAL BREAKAWAY | - 24 - |
| | | DATE: 12/20/2021 | | |
| <u>DOCUMENT NUMBER:</u> SD- 42375-001 | | <u>CREATED / REVISED BY:</u> SS06 | <u>CHECKED BY:</u> ISHWARG | <u>APPROVED BY:</u> ISHWARG |

| ENG. NO: A-42375-3569/3603 | | | | | |
|----------------------------|-----------------|--------------------|------|-----------------|------------|
| HEADER NUMBER: | | 42312-0036 | | | |
| PIN NUMBER: | | 42663-ABB208 | | | |
| PIN LENGTH: L | | .455 / 11.56 | | | |
| MATING LENGTH: M | | .240 / 6.09 | | | |
| GOLD POINT: G | | .100 / 2.54 | | | |
| PC TAIL LENGTH: P | | .125 / 3.18 | | | |
| TIN: T | | .100 / 2.54 | | | |
| CKTS: | | 4-36 | | | |
| KINKS: | | NO | | | |
| VOIDED CKTS: | | 5 | | | |
| PACKAGING: | | BULK PK-40873-0041 | | | |
| CKTS | MATERIAL NUMBER | ENG NUMBER | CKTS | MATERIAL NUMBER | ENG NUMBER |
| 02 | | | 20 | 423753587 | 42375-3587 |
| 03 | | | 21 | 423753588 | 42375-3588 |
| 04 | | | 22 | 423753589 | 42375-3589 |
| 05 | 423753572 | 42375-3572 | 23 | 423753590 | 42375-3590 |
| 06 | 423753573 | 42375-3573 | 24 | 423753591 | 42375-3591 |
| 07 | 423753574 | 42375-3574 | 25 | 423753592 | 42375-3592 |
| 08 | 423753575 | 42375-3575 | 26 | 423753593 | 42375-3593 |
| 09 | 423753576 | 42375-3576 | 27 | 423753594 | 42375-3594 |
| 10 | 423753577 | 42375-3577 | 28 | 423753595 | 42375-3595 |
| 11 | 423753578 | 42375-3578 | 29 | 423753596 | 42375-3596 |
| 12 | 423753579 | 42375-3579 | 30 | 423753597 | 42375-3597 |
| 13 | 423753580 | 42375-3580 | 31 | 423753598 | 42375-3598 |
| 14 | 423753581 | 42375-3581 | 32 | 423753599 | 42375-3599 |
| 15 | 423753582 | 42375-3582 | 33 | 423753600 | 42375-3600 |
| 16 | 423753583 | 42375-3583 | 34 | 423753601 | 42375-3601 |
| 17 | 423753584 | 42375-3584 | 35 | 423753602 | 42375-3602 |
| 18 | 423753585 | 42375-3585 | 36 | 423753603 | 42375-3603 |
| 19 | 423753586 | 42375-3586 | | | |

| ENG. NO: A-42375-2974/3008 | | | | | |
|----------------------------|-----------------|--------------------|------|-----------------|-------------|
| HEADER NUMBER: | | 42312-0036 | | | |
| PIN NUMBER: | | 42663-FKB228 | | | |
| PIN LENGTH: L | | 1.020 / 25.91 | | | |
| MATING LENGTH: M | | .805 / 20.45 | | | |
| GOLD POINT: G | | .200 / 5.08 | | | |
| PC TAIL LENGTH: P | | .125 / 3.18 | | | |
| TIN: T | | .200 / 5.08 | | | |
| CKTS: | | 2-36 | | | |
| KINKS: | | NO | | | |
| VOIDED CKTS: | | NONE | | | |
| PACKAGING: | | BULK PK-40873-0043 | | | |
| CKTS | MATERIAL NUMBER | ENG NUMBER | CKTS | MATERIAL NUMBER | ITEM NUMBER |
| 02 | | | 20 | | |
| 03 | | | 21 | | |
| 04 | | | 22 | | |
| 05 | 423752977 | 42375-2977 | 23 | | |
| 06 | | | 24 | | |
| 07 | | | 25 | | |
| 08 | | | 26 | | |
| 09 | | | 27 | | |
| 10 | | | 28 | | |
| 11 | | | 29 | | |
| 12 | | | 30 | | |
| 13 | | | 31 | | |
| 14 | | | 32 | | |
| 15 | | | 33 | | |
| 16 | | | 34 | | |
| 17 | | | 35 | | |
| 18 | | | 36 | | |
| 19 | | | | | |

| | | | | | |
|-------------------------|------|------------------------------|--------------------|---|------------------|
| U | REV: | <u>ECR/ECN INFORMATION:</u> | <u>TITLE:</u> | KK 100 HEADER ASSY FLAT VERTICAL BREAKAWAY | <u>SHEET No.</u> |
| | | EC No.: UCP2017-2793 | | | - 25 - |
| | | DATE: 12/20/2021 | | | |
| <u>DOCUMENT NUMBER:</u> | | <u>CREATED / REVISED BY:</u> | <u>CHECKED BY:</u> | <u>APPROVED BY:</u> | |
| SD- 42375-001 | | SS06 | ISHWARG | ISHWARG | |

| ENG. NO: A-42375-3604/3637 | | | | | |
|----------------------------|-----------------|--------------------|------|-----------------|------------|
| HEADER NUMBER: | | 42312-0036 | | | |
| PIN NUMBER: | | 42663-AXA154 | | | |
| PIN LENGTH: L | | .540 / 13.72 | | | |
| MATING LENGTH: M | | .380 / 9.65 | | | |
| GOLD POINT: G | | N/A | | | |
| PC TAIL LENGTH: P | | .070 / 1.78 | | | |
| TIN: T | | OVERALL | | | |
| CKTS: | | 3-36 | | | |
| KINKS: | | NO | | | |
| VOIDED CKTS: | | 2 | | | |
| PACKAGING: | | BULK PK-40873-0041 | | | |
| CKTS | MATERIAL NUMBER | ENG NUMBER | CKTS | MATERIAL NUMBER | ENG NUMBER |
| 02 | | | 20 | | |
| 03 | 42375-3604 | | 21 | | |
| 04 | | | 22 | | |
| 05 | | | 23 | | |
| 06 | | | 24 | | |
| 07 | | | 25 | | |
| 08 | | | 26 | | |
| 09 | | | 27 | | |
| 10 | | | 28 | | |
| 11 | | | 29 | | |
| 12 | | | 30 | | |
| 13 | | | 31 | | |
| 14 | | | 32 | | |
| 15 | | | 33 | | |
| 16 | | | 34 | | |
| 17 | | | 35 | | |
| 18 | | | 36 | | |
| 19 | | | | | |

| ENG. NO: A-42375-3638/3658 | | | | | |
|----------------------------|-----------------|----------------------------|------|-----------------|-------------|
| HEADER NUMBER: | | 42312-0036 | | | |
| PIN NUMBER: | | 42663-ABA154 | | | |
| PIN LENGTH: L | | .455 / 11.56 | | | |
| MATING LENGTH: M | | .240 / 6.09 | | | |
| GOLD POINT: G | | N/A | | | |
| PC TAIL LENGTH: P | | .125 / 3.18 | | | |
| TIN: T | | OVERALL | | | |
| CKTS: | | 2-36 | | | |
| KINKS: | | NO | | | |
| VOIDED CKTS: | | 2, 4, 6, 8, 10, 12, 14, 16 | | | |
| PACKAGING: | | BULK PK-40873-0041 | | | |
| CKTS | MATERIAL NUMBER | ENG NUMBER | CKTS | MATERIAL NUMBER | ITEM NUMBER |
| 02 | | | 20 | | |
| 03 | | | 21 | | |
| 04 | | | 22 | | |
| 05 | | | 23 | | |
| 06 | | | 24 | | |
| 07 | | | 25 | | |
| 08 | | | 26 | | |
| 09 | | | 27 | | |
| 10 | | | 28 | | |
| 11 | | | 29 | | |
| 12 | | | 30 | | |
| 13 | | | 31 | | |
| 14 | | | 32 | | |
| 15 | | | 33 | | |
| 16 | | | 34 | | |
| 17 | 423753639 | 42375-3639 | 35 | | |
| 18 | | | 36 | | |
| 19 | | | | | |

| | | | |
|--|--|---|--------------------------------|
| REV: U | ECR/ECN INFORMATION: EC No.: UCP2017-2793 DATE: 12/20/2021 | TITLE: KK 100 HEADER ASSY FLAT VERTICAL BREAKAWAY | SHEET No. - 26 - |
| DOCUMENT NUMBER: SD- 42375-001 | CREATED / REVISED BY: SS06 | CHECKED BY: ISHWARG | APPROVED BY: ISHWARG |

ENG. NO: 42375-3659/3693

| HEADER NUMBER: | 42312-0036 | | | | |
|-------------------|--------------------|------------|------|-----------------|------------|
| PIN NUMBER: | 42663-AXB208 | | | | |
| PIN LENGTH: L | .540 / 13.72 | | | | |
| MATING LENGTH: M | .250 / 6.35 | | | | |
| GOLD POINT: G | .140 / 3.56 | | | | |
| PC TAIL LENGTH: P | .200 / 5.08 | | | | |
| TIN: T | .135 / 3.43 | | | | |
| CKTS: | 2-36 | | | | |
| KINKS: | NO | | | | |
| VOIDED CKTS: | NONE | | | | |
| PACKAGING: | BULK PK-40873-0041 | | | | |
| CKTS | MATERIAL NUMBER | ENG NUMBER | CKTS | MATERIAL NUMBER | ENG NUMBER |
| 02 | 68300-2000 | 42375-3659 | 20 | | 42375-3677 |
| 03 | 68300-2001 | 42375-3660 | 21 | | 42375-3678 |
| 04 | | 42375-3661 | 22 | | 42375-3679 |
| 05 | 68300-2006 | 42375-3662 | 23 | | 42375-3680 |
| 06 | | 42375-3663 | 24 | | 42375-3681 |
| 07 | | 42375-3664 | 25 | | 42375-3682 |
| 08 | | 42375-3665 | 26 | | 42375-3683 |
| 09 | | 42375-3666 | 27 | | 42375-3684 |
| 10 | | 42375-3667 | 28 | | 42375-3685 |
| 11 | | 42375-3668 | 29 | | 42375-3686 |
| 12 | | 42375-3669 | 30 | | 42375-3687 |
| 13 | | 42375-3670 | 31 | | 42375-3688 |
| 14 | | 42375-3671 | 32 | | 42375-3689 |
| 15 | | 42375-3672 | 33 | | 42375-3690 |
| 16 | | 42375-3673 | 34 | | 42375-3691 |
| 17 | | 42375-3674 | 35 | | 42375-3692 |
| 18 | | 42375-3675 | 36 | | 42375-3693 |
| 19 | | 42375-3676 | | | |

ENG. NO: 42375-3694/3728

| HEADER NUMBER: | 42312-0036 | | | | |
|-------------------|--------------------|------------|------|-----------------|------------|
| PIN NUMBER: | 42663-AXB208 | | | | |
| PIN LENGTH: L | .540 / 13.72 | | | | |
| MATING LENGTH: M | .250 / 6.35 | | | | |
| GOLD POINT: G | .140 / 3.56 | | | | |
| PC TAIL LENGTH: P | .200 / 5.08 | | | | |
| TIN: T | .135 / 3.43 | | | | |
| CKTS: | 2-36 | | | | |
| KINKS: | NO | | | | |
| VOIDED CKTS: | 5 | | | | |
| PACKAGING: | BULK PK-40873-0041 | | | | |
| CKTS | MATERIAL NUMBER | ENG NUMBER | CKTS | MATERIAL NUMBER | ENG NUMBER |
| 02 | | 42375-3694 | 20 | | 42375-3712 |
| 03 | | 42375-3695 | 21 | | 42375-3713 |
| 04 | | 42375-3696 | 22 | | 42375-3714 |
| 05 | | 42375-3697 | 23 | | 42375-3715 |
| 06 | | 42375-3698 | 24 | | 42375-3716 |
| 07 | | 42375-3699 | 25 | | 42375-3717 |
| 08 | 68300-2002 | 42375-3700 | 26 | | 42375-3718 |
| 09 | | 42375-3701 | 27 | | 42375-3719 |
| 10 | | 42375-3702 | 28 | | 42375-3720 |
| 11 | | 42375-3703 | 29 | | 42375-3721 |
| 12 | | 42375-3704 | 30 | | 42375-3722 |
| 13 | | 42375-3705 | 31 | | 42375-3723 |
| 14 | | 42375-3706 | 32 | | 42375-3724 |
| 15 | | 42375-3707 | 33 | | 42375-3725 |
| 16 | | 42375-3708 | 34 | | 42375-3726 |
| 17 | | 42375-3709 | 35 | | 42375-3727 |
| 18 | | 42375-3710 | 36 | | 42375-3728 |
| 19 | | 42375-3711 | | | |

| | | | |
|--|--|---|--------------------------------|
| REV: U | ECR/ECN INFORMATION: EC No.: UCP2017-2793 DATE: 12/20/2021 | TITLE: KK 100 HEADER ASSY FLAT VERTICAL BREAKAWAY | SHEET No. - 27 - |
| DOCUMENT NUMBER: SD- 42375-001 | CREATED / REVISED BY: SS06 | CHECKED BY: ISHWARG | APPROVED BY: ISHWARG |

ENG. NO: 42375-3729/3763

| | |
|-------------------|--------------------|
| HEADER NUMBER: | 42312-0036 |
| PIN NUMBER: | 42663-AFB208 |
| PIN LENGTH: L | .475 / 12.07 |
| MATING LENGTH: M | .232 / 5.89 |
| GOLD POINT: G | .150 / 3.81 |
| PC TAIL LENGTH: P | .153 / 3.89 |
| TIN: T | .150 / 3.81 |
| CKTS: | 2-36 |
| KINKS: | NO |
| VOIDED CKTS: | 5 |
| PACKAGING: | BULK PK-40873-0041 |

| CKTS | MATERIAL NUMBER | ENG NUMBER | CKTS | MATERIAL NUMBER | ENG NUMBER |
|------|-----------------|------------|------|-----------------|------------|
| 02 | | 42375-3729 | 20 | | 42375-3747 |
| 03 | | 42375-3730 | 21 | | 42375-3748 |
| 04 | | 42375-3731 | 22 | | 42375-3749 |
| 05 | | 42375-3732 | 23 | | 42375-3750 |
| 06 | | 42375-3733 | 24 | | 42375-3751 |
| 07 | | 42375-3734 | 25 | | 42375-3752 |
| 08 | 68300-2007 | 42375-3735 | 26 | | 42375-3753 |
| 09 | | 42375-3736 | 27 | | 42375-3754 |
| 10 | | 42375-3737 | 28 | | 42375-3755 |
| 11 | | 42375-3738 | 29 | | 42375-3756 |
| 12 | | 42375-3739 | 30 | | 42375-3757 |
| 13 | | 42375-3740 | 31 | | 42375-3758 |
| 14 | | 42375-3741 | 32 | | 42375-3759 |
| 15 | | 42375-3742 | 33 | | 42375-3760 |
| 16 | | 42375-3743 | 34 | | 42375-3761 |
| 17 | | 42375-3744 | 35 | | 42375-3762 |
| 18 | | 42375-3745 | 36 | | 42375-3763 |
| 19 | | 42375-3746 | | | |

ENG. NO: 42375-3764/3798

| | |
|-------------------|--------------------|
| HEADER NUMBER: | 42312-0036 |
| PIN NUMBER: | 42663-ETA154 |
| PIN LENGTH: L | .950/24.13 |
| MATING LENGTH: M | .750/19.05 |
| GOLD POINT: G | N/A |
| PC TAIL LENGTH: P | .110/2.79 |
| TIN: T | OVERALL |
| CKTS: | 2-36 |
| KINKS: | NO |
| VOIDED CKTS: | 2 |
| PACKAGING: | BULK PK-40873-0043 |

| CKTS | ITEM NUMBER | CKTS | ITEM NUMBER |
|------|-------------|------|-------------|
| 02 | | 20 | |
| 03 | | 21 | |
| 04 | | 22 | |
| 05 | | 23 | |
| 06 | | 24 | |
| 07 | | 25 | |
| 08 | 42375-3770 | 26 | |
| 09 | | 27 | |
| 10 | | 28 | |
| 11 | | 29 | |
| 12 | | 30 | |
| 13 | | 31 | |
| 14 | | 32 | |
| 15 | | 33 | |
| 16 | | 34 | |
| 17 | | 35 | |
| 18 | | 36 | |
| 19 | | | |

| | | | | | |
|----------------------|------|-----------------------------|----------------|---|---------------|
| U | REV: | ECR/ECN INFORMATION: | TITLE: | KK 100 HEADER ASSY FLAT VERTICAL BREAKAWAY | SHEET No. |
| | | EC No.: UCP2017-2793 | | | - 28 - |
| | | DATE: 12/20/2021 | | | |
| DOCUMENT NUMBER: | | CREATED / REVISED BY: | CHECKED BY: | APPROVED BY: | |
| SD- 42375-001 | | SS06 | ISHWARG | ISHWARG | |

| ENG. NO: 42375-3799/3832 | | | |
|--------------------------|-----------------|--------------------|-----------------|
| HEADER NUMBER: | | 42312-0036 | |
| PIN NUMBER: | | 42663-ABA154 | |
| PIN LENGTH: L | | .455 / 11.56 | |
| MATING LENGTH: M | | .240 / 6.09 | |
| GOLD POINT: G | | N/A | |
| PC TAIL LENGTH: P | | .125 / 3.18 | |
| TIN: T | | OVERALL | |
| CKTS: | | 3-36 | |
| KINKS: | | NO | |
| VOIDED CKTS: | | 3 | |
| PACKAGING: | | BULK PK-40873-0041 | |
| CKTS | MATERIAL NUMBER | CKTS | MATERIAL NUMBER |
| 02 | | 20 | |
| 03 | | 21 | |
| 04 | | 22 | |
| 05 | 42375-3801 | 23 | |
| 06 | | 24 | |
| 07 | | 25 | |
| 08 | | 26 | |
| 09 | | 27 | |
| 10 | | 28 | |
| 11 | | 29 | |
| 12 | | 30 | |
| 13 | | 31 | |
| 14 | | 32 | |
| 15 | | 33 | |
| 16 | | 34 | |
| 17 | | 35 | |
| 18 | | 36 | |
| 19 | | | |

| ENG. NO: 42375-3733/3867 | | | |
|--------------------------|-----------------|--------------------|-----------------|
| HEADER NUMBER: | | 42312-0036 | |
| PIN NUMBER: | | 42663-ABB208 | |
| PIN LENGTH: L | | .455 / 11.56 | |
| MATING LENGTH: M | | .250 / 6.35 | |
| GOLD POINT: G | | .100 / 2.54 | |
| PC TAIL LENGTH: P | | .115 / 2.92 | |
| TIN: T | | .100 / 2.54 | |
| CKTS: | | 2-36 | |
| KINKS: | | NO | |
| VOIDED CKTS: | | NONE | |
| PACKAGING: | | BULK PK-40873-0041 | |
| CKTS | MATERIAL NUMBER | CKTS | MATERIAL NUMBER |
| 02 | | 20 | |
| 03 | | 21 | |
| 04 | | 22 | |
| 05 | 42375-3836 | 23 | |
| 06 | | 24 | |
| 07 | | 25 | |
| 08 | | 26 | |
| 09 | | 27 | |
| 10 | | 28 | |
| 11 | | 29 | |
| 12 | | 30 | |
| 13 | | 31 | |
| 14 | | 32 | |
| 15 | | 33 | |
| 16 | | 34 | |
| 17 | | 35 | |
| 18 | | 36 | |
| 19 | | | |

| ENG. NO: 42375-3868 / 3902 | | | |
|----------------------------|-------------|--------------------|-------------|
| HEADER NUMBER: | | 42312-0036 | |
| PIN NUMBER: | | 42663-DWA154 | |
| PIN LENGTH: L | | .850 / 21.59 | |
| MATING LENGTH: M | | .640 / 16.26 | |
| GOLD POINT: G | | N/A | |
| PC TAIL LENGTH: P | | .120 / 3.05 | |
| TIN: T | | OVERALL | |
| CKTS: | | 2-36 | |
| KINKS: | | NO | |
| VOIDED CKTS: | | NONE | |
| PACKAGING: | | BULK PK-40873-0041 | |
| CKTS | ITEM NUMBER | CKTS | ITEM NUMBER |
| 02 | | 20 | |
| 03 | | 21 | |
| 04 | 42375-3870 | 22 | |
| 05 | | 23 | |
| 06 | 42375-3872 | 24 | |
| 07 | | 25 | |
| 08 | | 26 | |
| 09 | | 27 | |
| 10 | | 28 | |
| 11 | | 29 | |
| 12 | | 30 | |
| 13 | | 31 | |
| 14 | | 32 | |
| 15 | | 33 | |
| 16 | | 34 | |
| 17 | | 35 | |
| 18 | | 36 | |
| 19 | | | |

| | | | | | |
|-------------------------|------|------------------------------|--------------------|---|------------------|
| U | REV: | <u>ECR/ECN INFORMATION:</u> | <u>TITLE:</u> | KK 100 HEADER ASSY FLAT VERTICAL BREAKAWAY | <u>SHEET No.</u> |
| | | EC No.: UCP2017-2793 | | | - 29 - |
| | | DATE: 12/20/2021 | | | |
| <u>DOCUMENT NUMBER:</u> | | <u>CREATED / REVISED BY:</u> | <u>CHECKED BY:</u> | <u>APPROVED BY:</u> | |
| SD- 42375-001 | | SS06 | ISHWARG | ISHWARG | |

| ENG. NO: 42375-3903/3932 | | | |
|--------------------------|-----------------|--------------------|-----------------|
| HEADER NUMBER: | | 42312-0036 | |
| PIN NUMBER: | | 42663-BSA154 | |
| PIN LENGTH: L | | .630 / 16.00 | |
| MATING LENGTH: M | | .421 / 10.69 | |
| GOLD POINT: G | | N/A | |
| PC TAIL LENGTH: P | | .119 / 3.02 | |
| TIN: T | | OVERALL | |
| CKTS: | | 7-36 | |
| KINKS: | | NO | |
| VOIDED CKTS: | | 7 | |
| PACKAGING: | | BULK PK-40873-0041 | |
| CKTS | MATERIAL NUMBER | CKTS | MATERIAL NUMBER |
| 02 | | 20 | |
| 03 | | 21 | |
| 04 | | 22 | |
| 05 | | 23 | |
| 06 | | 24 | |
| 07 | | 25 | |
| 08 | 42375-3904 | 26 | |
| 09 | | 27 | |
| 10 | | 28 | |
| 11 | | 29 | |
| 12 | | 30 | |
| 13 | | 31 | |
| 14 | | 32 | |
| 15 | | 33 | |
| 16 | | 34 | |
| 17 | | 35 | |
| 18 | | 36 | |
| 19 | | | |

| ENG. NO: 42375-3933/3964 | | | |
|--------------------------|-----------------|--------------------|-----------------|
| HEADER NUMBER: | | 42312-0036 | |
| PIN NUMBER: | | 42663-BSA154 | |
| PIN LENGTH: L | | .630 / 16.00 | |
| MATING LENGTH: M | | .405/10.29 | |
| GOLD POINT: G | | N/A | |
| PC TAIL LENGTH: P | | .135/3.43 | |
| TIN: T | | OVERALL | |
| CKTS: | | 5-36 | |
| KINKS: | | SMES-42003 | |
| VOIDED CKTS: | | 5 | |
| PACKAGING: | | BULK PK-40873-0041 | |
| CKTS | MATERIAL NUMBER | CKTS | MATERIAL NUMBER |
| 02 | | 20 | |
| 03 | | 21 | |
| 04 | | 22 | |
| 05 | | 23 | |
| 06 | | 24 | |
| 07 | | 25 | |
| 08 | | 26 | |
| 09 | 42375-3937 | 27 | |
| 10 | | 28 | |
| 11 | | 29 | |
| 12 | | 30 | |
| 13 | | 31 | |
| 14 | | 32 | |
| 15 | | 33 | |
| 16 | | 34 | |
| 17 | | 35 | |
| 18 | | 36 | |
| 19 | | | |

| ENG. NO: 42375-3965/3995 | | | |
|--------------------------|-----------------|--------------------|-----------------|
| HEADER NUMBER: | | 42312-0036 | |
| PIN NUMBER: | | 42663-BSA154 | |
| PIN LENGTH: L | | .630 / 16.00 | |
| MATING LENGTH: M | | .405/10.29 | |
| GOLD POINT: G | | N/A | |
| PC TAIL LENGTH: P | | .135/3.43 | |
| TIN: T | | OVERALL | |
| CKTS: | | 6-36 | |
| KINKS: | | SMES-42003 | |
| VOIDED CKTS: | | 4, 5, 6 | |
| PACKAGING: | | BULK PK-40873-0041 | |
| CKTS | MATERIAL NUMBER | CKTS | MATERIAL NUMBER |
| 02 | | 20 | |
| 03 | | 21 | |
| 04 | | 22 | |
| 05 | | 23 | |
| 06 | | 24 | |
| 07 | | 25 | |
| 08 | | 26 | |
| 09 | 42375-3968 | 27 | |
| 10 | | 28 | |
| 11 | | 29 | |
| 12 | | 30 | |
| 13 | | 31 | |
| 14 | | 32 | |
| 15 | | 33 | |
| 16 | | 34 | |
| 17 | | 35 | |
| 18 | | 36 | |
| 19 | | | |

| | | | | | |
|---|-----------------------------|--|---|--------------------------------------|---------------------------------------|
| U | <u>ECR/ECN INFORMATION:</u> | | KK 100 HEADER ASSY FLAT VERTICAL BREAKAWAY | <u>SHEET No.</u> | |
| | EC No.: UCP2017-2793 | | | - 30 - | |
| | DATE: 12/20/2021 | | | | |
| <u>DOCUMENT NUMBER:</u> SD- 42375-001 | | | <u>CREATED / REVISED BY:</u> SS06 | <u>CHECKED BY:</u> ISHWARG | <u>APPROVED BY:</u> ISHWARG |

| | | | |
|----------------------------|-------------|--------------------|-------------|
| ENG. NO: A-42375-3996/4030 | | | |
| HEADER NUMBER: | | 42312-0036 | |
| PIN NUMBER: | | 42663-AXA154 | |
| PIN LENGTH: L | | .540 / 13.72 | |
| MATING LENGTH: M | | .390 / 9.91 | |
| GOLD POINT: G | | N/A | |
| PC TAIL LENGTH: P | | .060 / 1.52 | |
| TIN: T | | OVERALL | |
| CKTS: | | 2-36 | |
| KINKS: | | NO | |
| VOIDED CKTS: | | NONE | |
| PACKAGING: | | BULK PK-40873-0041 | |
| CKTS | ITEM NUMBER | CKTS | ITEM NUMBER |
| 02 | | 20 | |
| 03 | | 21 | |
| 04 | | 22 | |
| 05 | | 23 | |
| 06 | 42375-4000 | 24 | |
| 07 | 42375-4001 | 25 | |
| 08 | | 26 | |
| 09 | | 27 | |
| 10 | | 28 | |
| 11 | | 29 | |
| 12 | | 30 | |
| 13 | | 31 | |
| 14 | | 32 | |
| 15 | | 33 | |
| 16 | | 34 | |
| 17 | | 35 | |
| 18 | | 36 | |
| 19 | | | |

| | | | |
|--------------------------|-----------------|--------------------|-----------------|
| ENG. NO: 42375-4031/4059 | | | |
| HEADER NUMBER: | | 42312-0036 | |
| PIN NUMBER: | | 42663-ABA154 | |
| PIN LENGTH: L | | .455 / 11.56 | |
| MATING LENGTH: M | | .240 / 6.09 | |
| GOLD POINT: G | | N/A | |
| PC TAIL LENGTH: P | | .125 / 3.18 | |
| TIN: T | | OVERALL | |
| CKTS: | | 8-36 | |
| KINKS: | | NO | |
| VOIDED CKTS: | | 2, 4, 6, 8 | |
| PACKAGING: | | BULK PK-40873-0041 | |
| CKTS | MATERIAL NUMBER | CKTS | MATERIAL NUMBER |
| 02 | | 20 | |
| 03 | | 21 | |
| 04 | | 22 | |
| 05 | | 23 | |
| 06 | | 24 | |
| 07 | | 25 | |
| 08 | | 26 | |
| 09 | 42375-4032 | 27 | |
| 10 | | 28 | |
| 11 | | 29 | |
| 12 | | 30 | |
| 13 | | 31 | |
| 14 | | 32 | |
| 15 | | 33 | |
| 16 | | 34 | |
| 17 | | 35 | |
| 18 | | 36 | |
| 19 | | | |

| | | | |
|----------------------------|-----------------|--------------------|-----------------|
| ENG. NO: 42375-4060 / 4094 | | | |
| HEADER NUMBER: | | 42312-0036 | |
| PIN NUMBER: | | 42663-CGA154 | |
| PIN LENGTH: L | | .690 / 17.53 | |
| MATING LENGTH: M | | .521 / 13.23 | |
| GOLD POINT: G | | N/A | |
| PC TAIL LENGTH: P | | .079 / 2.01 | |
| TIN: T | | OVERALL | |
| CKTS: | | 2-36 | |
| KINKS: | | NO | |
| VOIDED CKTS: | | NONE | |
| PACKAGING: | | BULK PK-40873-0041 | |
| CKTS | MATERIAL NUMBER | CKTS | MATERIAL NUMBER |
| 02 | | 20 | |
| 03 | | 21 | |
| 04 | | 22 | |
| 05 | | 23 | |
| 06 | 42375-4064 | 24 | |
| 07 | | 25 | |
| 08 | | 26 | |
| 09 | | 27 | |
| 10 | | 28 | |
| 11 | | 29 | |
| 12 | | 30 | |
| 13 | | 31 | |
| 14 | | 32 | |
| 15 | | 33 | |
| 16 | | 34 | |
| 17 | | 35 | |
| 18 | | 36 | |
| 19 | | | |

| | | | |
|--|--|---|--------------------------------|
| REV: U | ECR/ECN INFORMATION: EC No.: UCP2017-2793 DATE: 12/20/2021 | TITLE: KK 100 HEADER ASSY FLAT VERTICAL BREAKAWAY | SHEET No. - 31 - |
| DOCUMENT NUMBER: SD- 42375-001 | CREATED / REVISED BY: SS06 | CHECKED BY: ISHWARG | APPROVED BY: ISHWARG |

| ENG. NO: A-42375-4095/4129 | | | |
|----------------------------|-------------|--------------------|-------------|
| HEADER NUMBER: | | 42312-0036 | |
| PIN NUMBER: | | 42663-DEB228 | |
| PIN LENGTH: L | | .785 / 19.94 | |
| MATING LENGTH: M | | .470 / 11.94 | |
| GOLD POINT: G | | .250 / 6.35 | |
| PC TAIL LENGTH: P | | .225 / 5.72 | |
| TIN: T | | .200 / 5.08 | |
| CKTS: | | 2-36 | |
| KINKS: | | NO | |
| VOIDED CKTS: | | NONE | |
| PACKAGING: | | BULK PK-40873-0041 | |
| CKTS | ITEM NUMBER | CKTS | ITEM NUMBER |
| 02 | | 20 | |
| 03 | | 21 | |
| 04 | | 22 | |
| 05 | | 23 | |
| 06 | | 24 | |
| 07 | | 25 | |
| 08 | | 26 | |
| 09 | | 27 | |
| 10 | 42375-4103 | 28 | |
| 11 | | 29 | |
| 12 | | 30 | |
| 13 | | 31 | |
| 14 | | 32 | |
| 15 | | 33 | |
| 16 | | 34 | |
| 17 | | 35 | |
| 18 | 42375-4111 | 36 | |
| 19 | | | |

| ENG. NO: A-42375-4130/4161 | | | |
|----------------------------|-------------|--------------------|-------------|
| HEADER NUMBER: | | 42312-0036 | |
| PIN NUMBER: | | 42663-ATA154 | |
| PIN LENGTH: L | | .530/13.46 | |
| MATING LENGTH: M | | .320/8.13 | |
| GOLD POINT: G | | N/A | |
| PC TAIL LENGTH: P | | .120/3.05 | |
| TIN: T | | OVERALL | |
| CKTS: | | 5-36 | |
| KINKS: | | SMES-42003 | |
| VOIDED CKTS: | | 2, 3, 4 | |
| PACKAGING: | | BULK PK-40873-0041 | |
| CKTS | ITEM NUMBER | CKTS | ITEM NUMBER |
| | | 20 | |
| | | 21 | |
| | | 22 | |
| 05 | 42375-4130 | 23 | |
| 06 | | 24 | |
| 07 | | 25 | |
| 08 | | 26 | |
| 09 | | 27 | |
| 10 | | 28 | |
| 11 | | 29 | |
| 12 | | 30 | |
| 13 | | 31 | |
| 14 | | 32 | |
| 15 | | 33 | |
| 16 | | 34 | |
| 17 | | 35 | |
| 18 | | 36 | |
| 19 | | | |

| ENG. NO: 42375-4162/4196 | | | |
|--------------------------|-----------------|--------------------|-----------------|
| HEADER NUMBER: | | 42312-0036 | |
| PIN NUMBER: | | 42663-BSC228 | |
| PIN LENGTH: L | | .630/16.00 | |
| MATING LENGTH: M | | .400/10.16 | |
| GOLD POINT: G | | .345/8.76 | |
| PC TAIL LENGTH: P | | .140/3.56 | |
| TIN: T | | .100/2.54 | |
| CKTS: | | 2-36 | |
| KINKS: | | NO | |
| VOIDED CKTS: | | NONE | |
| PACKAGING: | | BULK PK-40873-0041 | |
| CKTS | MATERIAL NUMBER | CKTS | MATERIAL NUMBER |
| 02 | | 20 | |
| 03 | | 21 | |
| 04 | 42375-4164 | 22 | |
| 05 | 42375-4165 | 23 | |
| 06 | | 24 | |
| 07 | | 25 | |
| 08 | | 26 | |
| 09 | | 27 | |
| 10 | 42375-4170 | 28 | |
| 11 | | 29 | |
| 12 | | 30 | |
| 13 | | 31 | |
| 14 | | 32 | |
| 15 | | 33 | |
| 16 | | 34 | |
| 17 | | 35 | |
| 18 | | 36 | |
| 19 | | | |

| | | | | |
|-------------------------|------|------------------------------|---|---------------------|
| U | REV: | <u>ECR/ECN INFORMATION:</u> | <u>TITLE:</u> | <u>SHEET No.</u> |
| | | EC No.: UCP2017-2793 | KK 100 HEADER ASSY FLAT VERTICAL BREAKAWAY | - 32 - |
| | | DATE: 12/20/2021 | | |
| <u>DOCUMENT NUMBER:</u> | | <u>CREATED / REVISED BY:</u> | <u>CHECKED BY:</u> | <u>APPROVED BY:</u> |
| SD- 42375-001 | | SS06 | ISHWARG | ISHWARG |

| ENG. NO: A-42375-1622 | | | |
|-----------------------|-----------------|--------------------|-----------------|
| HEADER NUMBER: | | 42312-0036 | |
| PIN NUMBER: | | 42663-AYB208 | |
| PIN LENGTH: L | | .545 / 13.84 | |
| MATING LENGTH: M | | .320 / 8.13 | |
| GOLD POINT: G | | .140 / 3.56 | |
| PC TAIL LENGTH: P | | .135 / 3.43 | |
| TIN: T | | .135 / 3.43 | |
| CKTS: | | 2-36 | |
| KINKS: | | SMES-42003 | |
| VOIDED CKTS: | | 3 | |
| PACKAGING: | | BULK PK-40873-0041 | |
| CKTS | MATERIAL NUMBER | CKTS | MATERIAL NUMBER |
| 02 | | 20 | |
| 03 | | 21 | |
| 04 | | 22 | |
| 05 | | 23 | |
| 06 | | 24 | |
| 07 | | 25 | |
| 08 | | 26 | |
| 09 | 42375-1622 | 27 | |
| 10 | | 28 | |
| 11 | | 29 | |
| 12 | | 30 | |
| 13 | | 31 | |
| 14 | | 32 | |
| 15 | | 33 | |
| 16 | | 34 | |
| 17 | | 35 | |
| 18 | | 36 | |
| 19 | | | |

| ENG. NO: A-42375-4199 | | | |
|-----------------------|-----------------|--------------------|-----------------|
| HEADER NUMBER: | | 42312-0036 | |
| PIN NUMBER: | | 42663-ARB228 | |
| PIN LENGTH: L | | .520 / 13.21 | |
| MATING LENGTH: M | | .230 / 5.84 | |
| GOLD POINT: G | | .140 / 3.56 | |
| PC TAIL LENGTH: P | | .200 / 5.08 | |
| TIN: T | | .135 / 3.43 | |
| CKTS: | | 2-36 | |
| KINKS: | | NO | |
| VOIDED CKTS: | | NONE | |
| PACKAGING: | | BULK PK-40873-0041 | |
| CKTS | MATERIAL NUMBER | CKTS | MATERIAL NUMBER |
| 02 | 42375-4199 | 20 | |
| 03 | | 21 | |
| 04 | | 22 | |
| 05 | | 23 | |
| 06 | | 24 | |
| 07 | | 25 | |
| 08 | | 26 | |
| 09 | | 27 | |
| 10 | | 28 | |
| 11 | | 29 | |
| 12 | | 30 | |
| 13 | | 31 | |
| 14 | | 32 | |
| 15 | | 33 | |
| 16 | | 34 | |
| 17 | | 35 | |
| 18 | | 36 | |
| 19 | | | |

| ENG. NO: A-42375-4200 | | | |
|-----------------------|-----------------|--------------------|-----------------|
| HEADER NUMBER: | | 42312-0036 | |
| PIN NUMBER: | | 42663-ADB208 | |
| PIN LENGTH: L | | .465 / 11.81 | |
| MATING LENGTH: M | | .240 / 6.09 | |
| GOLD POINT: G | | .100 / 2.54 | |
| PC TAIL LENGTH: P | | .135 / 3.43 | |
| TIN: T | | .100 / 2.54 | |
| CKTS: | | 2-36 | |
| KINKS: | | SMES-42003 | |
| VOIDED CKTS: | | 3, 4 | |
| PACKAGING: | | BULK PK-40873-0041 | |
| CKTS | MATERIAL NUMBER | CKTS | MATERIAL NUMBER |
| 02 | | 20 | |
| 03 | | 21 | |
| 04 | | 22 | |
| 05 | 42375-4200 | 23 | |
| 06 | | 24 | |
| 07 | | 25 | |
| 08 | | 26 | |
| 09 | | 27 | |
| 10 | | 28 | |
| 11 | | 29 | |
| 12 | | 30 | |
| 13 | | 31 | |
| 14 | | 32 | |
| 15 | | 33 | |
| 16 | | 34 | |
| 17 | | 35 | |
| 18 | | 36 | |
| 19 | | | |

| | | | | |
|-------------------------|------|------------------------------|---|---------------------|
| U | REV: | <u>ECR/ECN INFORMATION:</u> | <u>TITLE:</u> | <u>SHEET No.</u> |
| | | EC No.: UCP2017-2793 | KK 100 HEADER ASSY FLAT VERTICAL BREAKAWAY | - 33 - |
| | | DATE: 12/20/2021 | | |
| <u>DOCUMENT NUMBER:</u> | | <u>CREATED / REVISED BY:</u> | <u>CHECKED BY:</u> | <u>APPROVED BY:</u> |
| SD- 42375-001 | | SS06 | ISHWARG | ISHWARG |

| ENG. NO: 42375-4236 | | | |
|---------------------|-------------|--------------------|-------------|
| HEADER NUMBER: | | 42312-0036 | |
| PIN NUMBER: | | 42663-CCA118 | |
| PIN LENGTH: L | | .670 / 17.02 | |
| MATING LENGTH: M | | .440 / 11.18 | |
| GOLD POINT: G | | NA | |
| PC TAIL LENGTH: P | | .140 / 3.56 | |
| TIN: T | | OVERALL | |
| CKTS: | | 2-36 | |
| KINKS: | | SMES-42003 | |
| VOIDED CKTS: | | NONE | |
| PACKAGING: | | BULK PK-40873-0041 | |
| CKTS | ITEM NUMBER | CKTS | ITEM NUMBER |
| 02 | | 20 | |
| 03 | | 21 | |
| 04 | | 22 | |
| 05 | | 23 | |
| 06 | 42375-4236 | 24 | |
| 07 | | 25 | |
| 08 | | 26 | |
| 09 | | 27 | |
| 10 | | 28 | |
| 11 | | 29 | |
| 12 | | 30 | |
| 13 | | 31 | |
| 14 | | 32 | |
| 15 | | 33 | |
| 16 | | 34 | |
| 17 | | 35 | |
| 18 | | 36 | |
| 19 | | | |

| ENG. NO: 42375-4305 | | | |
|---------------------|-----------------|--------------------|-----------------|
| HEADER NUMBER: | | 42312-0036 | |
| PIN NUMBER: | | 42663-BDA154 | |
| PIN LENGTH: L | | .570 / 14.48 | |
| MATING LENGTH: M | | .339 / 8.61 | |
| GOLD POINT: G | | N/A | |
| PC TAIL LENGTH: P | | .141 / 3.58 | |
| TIN: T | | OVERALL | |
| CKTS: | | 2-36 | |
| KINKS: | | NO | |
| VOIDED CKTS: | | NONE | |
| PACKAGING: | | BULK PK-40873-0041 | |
| CKTS | MATERIAL NUMBER | CKTS | MATERIAL NUMBER |
| 02 | | 20 | |
| 03 | | 21 | |
| 04 | | 22 | |
| 05 | 42375-4305 | 23 | |
| 06 | | 24 | |
| 07 | | 25 | |
| 08 | | 26 | |
| 09 | | 27 | |
| 10 | | 28 | |
| 11 | | 29 | |
| 12 | | 30 | |
| 13 | | 31 | |
| 14 | | 32 | |
| 15 | | 33 | |
| 16 | | 34 | |
| 17 | | 35 | |
| 18 | | 36 | |
| 19 | | | |

| ENG. NO: 42375-4338/4341 | | | |
|--------------------------|-----------------|--------------------|-----------------|
| HEADER NUMBER: | | 42312-0036 | |
| PIN NUMBER: | | 42663-BGA154 | |
| PIN LENGTH: L | | .585 / 14.86 | |
| MATING LENGTH: M | | .398 / 10.11 | |
| GOLD POINT: G | | N/A | |
| PC TAIL LENGTH: P | | .097 / 2.46 | |
| TIN: T | | OVERALL | |
| CKTS: | | 2-36 | |
| KINKS: | | NO | |
| VOIDED CKTS: | | NONE | |
| PACKAGING: | | BULK PK-40873-0041 | |
| CKTS | MATERIAL NUMBER | CKTS | MATERIAL NUMBER |
| 02 | | 20 | |
| 03 | 42375-4338 | 21 | |
| 04 | | 22 | |
| 05 | | 23 | |
| 06 | 42375-4341 | 24 | |
| 07 | | 25 | |
| 08 | | 26 | |
| 09 | | 27 | |
| 10 | | 28 | |
| 11 | | 29 | |
| 12 | | 30 | |
| 13 | | 31 | |
| 14 | | 32 | |
| 15 | | 33 | |
| 16 | | 34 | |
| 17 | | 35 | |
| 18 | | 36 | |
| 19 | | | |

| | | | | |
|---|------|---|---|---------------------------------------|
| U | REV: | <u>ECR/ECN INFORMATION:</u> | <u>TITLE:</u> | <u>SHEET No.</u> |
| | | EC No.: UCP2017-2793 | KK 100 HEADER ASSY FLAT VERTICAL BREAKAWAY | - 34 - |
| | | DATE: 12/20/2021 | | |
| <u>DOCUMENT NUMBER:</u> SD- 42375-001 | | <u>CREATED / REVISED BY:</u> SS06 | <u>CHECKED BY:</u> ISHWARG | <u>APPROVED BY:</u> ISHWARG |

| ENG. NO: 42375-4413 | | | |
|---------------------|-------------|--------------------|-------------|
| HEADER NUMBER: | | 42312-0036 | |
| PIN NUMBER: | | 42663-ABB208 | |
| PIN LENGTH: L | | .455 / 11.56 | |
| MATING LENGTH: M | | .240 / 6.09 | |
| GOLD POINT: G | | .100 / 2.54 | |
| PC TAIL LENGTH: P | | .125 / 3.18 | |
| TIN: T | | .100 / 2.54 | |
| CKTS: | | 6-36 | |
| KINKS: | | NO | |
| VOIDED CKTS: | | 2, 4, 6 | |
| PACKAGING: | | BULK PK-40873-0041 | |
| CKTS | ITEM NUMBER | CKTS | ITEM NUMBER |
| 02 | | 20 | |
| 03 | | 21 | |
| 04 | | 22 | |
| 05 | | 23 | |
| 06 | | 24 | |
| 07 | 42375-4413 | 25 | |
| 08 | | 26 | |
| 09 | | 27 | |
| 10 | | 28 | |
| 11 | | 29 | |
| 12 | | 30 | |
| 13 | | 31 | |
| 14 | | 32 | |
| 15 | | 33 | |
| 16 | | 34 | |
| 17 | | 35 | |
| 18 | | 36 | |
| 19 | | | |

| ENG. NO: 42375-4445 | | | |
|---------------------|-----------------|--------------------|-----------------|
| HEADER NUMBER: | | 42312-0036 | |
| PIN NUMBER: | | 42663-0364 | |
| PLATING: | | 228 | |
| PIN LENGTH: L | | .590 / 14.99 | |
| MATING LENGTH: M | | .380 / 9.65 | |
| GOLD POINT: G | | .200 / 5.08 | |
| PC TAIL LENGTH: P | | .120 / 3.05 | |
| TIN: T | | .135 / 3.43 | |
| CKTS: | | 2-36 | |
| KINKS: | | NO | |
| VOIDED CKTS: | | NONE | |
| PACKAGING: | | BULK PK-40873-0041 | |
| CKTS | MATERIAL NUMBER | CKTS | MATERIAL NUMBER |
| 02 | | 20 | |
| 03 | | 21 | |
| 04 | 42375-4445 | 22 | |
| 05 | | 23 | |
| 06 | | 24 | |
| 07 | | 25 | |
| 08 | | 26 | |
| 09 | | 27 | |
| 10 | | 28 | |
| 11 | | 29 | |
| 12 | | 30 | |
| 13 | | 31 | |
| 14 | | 32 | |
| 15 | | 33 | |
| 16 | | 34 | |
| 17 | | 35 | |
| 18 | | 36 | |
| 19 | | | |

| | | | | |
|-------------------------|------|------------------------------|---|---------------------|
| U | REV: | <u>ECR/ECN INFORMATION:</u> | <u>TITLE:</u> | <u>SHEET No.</u> |
| | | EC No.: UCP2017-2793 | KK 100 HEADER ASSY FLAT VERTICAL BREAKAWAY | - 35 - |
| | | DATE: 12/20/2021 | | |
| <u>DOCUMENT NUMBER:</u> | | <u>CREATED / REVISED BY:</u> | <u>CHECKED BY:</u> | <u>APPROVED BY:</u> |
| SD- 42375-001 | | SS06 | ISHWARG | ISHWARG |

ENG. NO: 42375-4549

| | |
|-------------------|----------------------------|
| HEADER NUMBER: | 42312-0036 |
| PIN NUMBER: | 42663-ABB208 |
| PIN LENGTH: L | .455 / 11.56 |
| MATING LENGTH: M | .240 / 6.09 |
| GOLD POINT: G | .100 / 2.54 |
| PC TAIL LENGTH: P | .125 / 3.18 |
| TIN: T | .100 / 2.54 |
| CKTS: | 2-36 |
| KINKS: | NO |
| VOIDED CKTS: | NONE |
| PACKAGING: | TAPE AND REEL 423751000-PK |

| CKTS | MATERIAL NUMBER | ENG NUMBER | CKTS | MATERIAL NUMBER | ENG NUMBER |
|------|-----------------|------------|------|-----------------|------------|
| 02 | 22-28-4029 | 42375-4549 | 20 | | |
| 03 | | | 21 | | |
| 04 | | | 22 | | |
| 05 | | | 23 | | |
| 06 | | | 24 | | |
| 07 | | | 25 | | |
| 08 | | | 26 | | |
| 09 | | | 27 | | |
| 10 | | | 28 | | |
| 11 | | | 29 | | |
| 12 | | | 30 | | |
| 13 | | | 31 | | |
| 14 | | | 32 | | |
| 15 | | | 33 | | |
| 16 | | | 34 | | |
| 17 | | | 35 | | |
| 18 | | | 36 | | |
| 19 | | | | | |

| | | | |
|--|--|---|--------------------------------|
| REV: U | ECR/ECN INFORMATION: EC No.: UCP2017-2793 DATE: 12/20/2021 | TITLE: KK 100 HEADER ASSY FLAT VERTICAL BREAKAWAY | SHEET No. - 36 - |
| DOCUMENT NUMBER: SD- 42375-001 | CREATED / REVISED BY: SS06 | CHECKED BY: ISHWARG | APPROVED BY: ISHWARG |