

**Mounting Option**

M3-0.5 Metric Threaded Inserts

**Contact Detail**

Wire Wrap .046x.013(1.17x0.33) - Tail LG=.708(17.98)

.156 [3.96] Contact Spacing x .200 [5.08] Row Spacing

THIS IS A C.A.D. GENERATED DRAWING  
DO NOT MAKE MANUAL REVISIONS TO MASTER.



ISSUE NUMBER

ORIGINAL

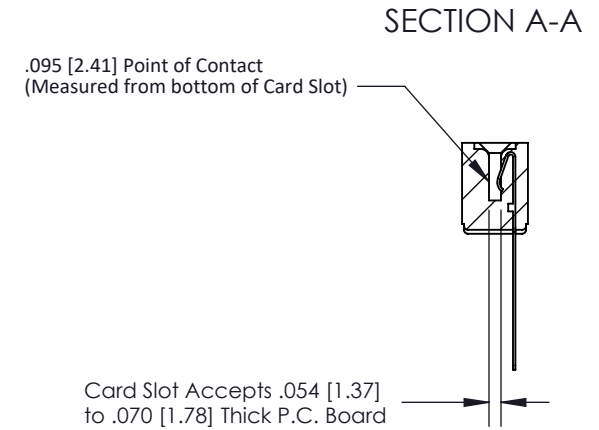
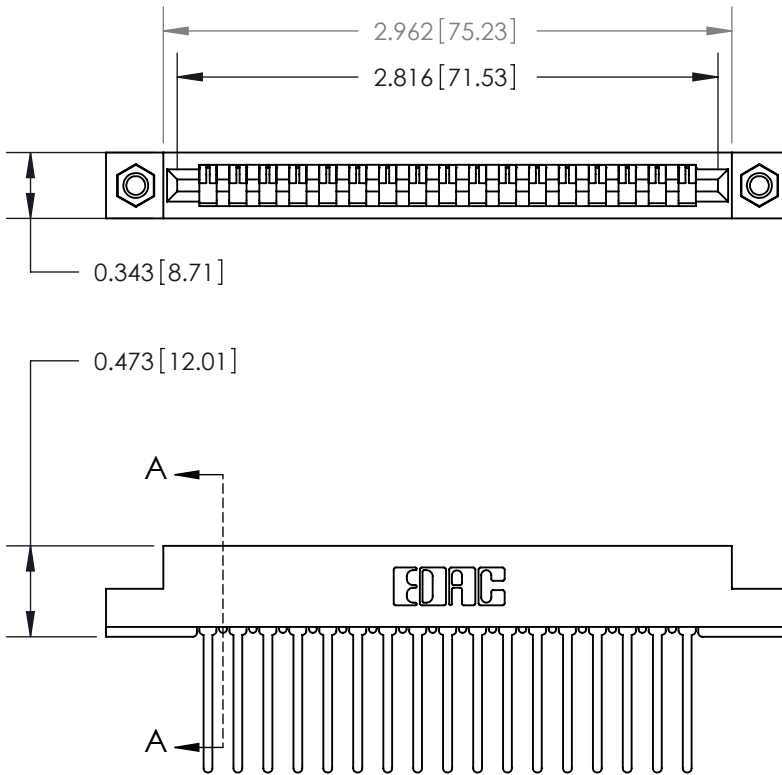

See Accompanying Page for:

- Contact Bend Details

807/857 Series High Temp Card Edge Connector

Part Number: 807-017-445-107



EDAC INC  
TORONTO, ONTARIO  
CANADA

YOUR CONNECTION TO QUALITY & SERVICE

THESE DRAWINGS AND SPECIFICATIONS  
ARE THE PROPERTY OF EDAC INC. AND  
SHALL NOT BE REPRODUCED, OR COPIED  
OR USED AS THE BASIS FOR THE  
MANUFACTURE OR SALE OF APPARATUS  
WITHOUT WRITTEN PERMISSION.

ACAD REFERENCE NO. 807 ENG MASTER

DRAWN: J.LEE DATE: AUG. 11/09

CHECKED: DATE:

SCALE: NTS SHEET 1 OF 2

DRAWING NUMBER ISSUE

807 Assembly

1

**Single Row Contacts - Read One Side of Daughter Board**

THIS IS A C.A.D. GENERATED DRAWING  
DO NOT MAKE MANUAL REVISIONS TO MASTER.



ISSUE NUMBER  
ORIGINAL



558 Contact Code



559 Contact Code

**Single Row Contacts - Read Both Sides of Daughter Board**



553 Contact Code



554 Contact Code



557 Contact Code

**Dual Row Contacts - Read Both Sides of Daughter Board**



555 Contact Code



556 Contact Code

0.240 [6.10] Up to 27/54 Pin  
0.162 [4.11] 28/56 and Over



558 Contact Code

0.240 [6.10] Up to 27/54 Pin  
0.162 [4.11] 28/56 and Over  
0.290 [7.37] Up to 27/54 Pin  
.212 [5.38] 28/56 and Over



559 Contact Code



560 Contact Code

**807 Series High Temp Card Edge Connector  
Contact Bend Detail**



EDAC INC  
TORONTO, ONTARIO  
CANADA

YOUR CONNECTION TO QUALITY & SERVICE

THESE DRAWINGS AND SPECIFICATIONS  
ARE THE PROPERTY OF EDAC INC. AND  
SHALL NOT BE REPRODUCED, OR COPIED  
OR USED AS THE BASIS FOR THE  
MANUFACTURE OR SALE OF APPARATUS  
WITHOUT WRITTEN PERMISSION.

ACAD REFERENCE NO. 807 ENG MASTER

DRAWN: J.LEE DATE: AUG. 11/09

CHECKED: DATE:

SCALE: NTS SHEET 2 OF 2

DRAWING NUMBER ISSUE

807 Assembly

1