

DESCRIPTION: POWER / SIGNAL - VERTICAL - FEMALE - MACHINED

SPECIFICATIONS:

ELECTRICAL:

INSULATION RESISTANCE: 5 GOhms MIN.
 DIELECTRIC WITHSTANDING VOLTAGE: 1000 VAC FOR 1 MIN
 WORKING VOLTAGE: 250V
 OPERATING TEMPERATURE: -55°C TO +125°C
 POWER CONTACT RESISTANCE: 2.0 mOhms MAX.
 SIGNAL CONTACT RESISTANCE: 10 mOhms MAX.
 POWER CONTACT AMPERAGE: SEE P/N KEY
 SIGNAL CONTACT AMPERAGE: 5 AMPS

MECHANICAL:

CONTACT INSERTION FORCE: 4.5 Kg MAX.
 CONTACT SEPARATION FORCE: 0.3 Kg MIN.

MATERIALS:

CONTACTS: COPPER ALLOY, GOLD FLASH
 INSULATOR: PBT UL94V-0 RATED
 230°C PROCESS TEMP.
 SHELL: NICKEL PLATED STEEL
 HARDWARE: NICKEL PLATED BRASS

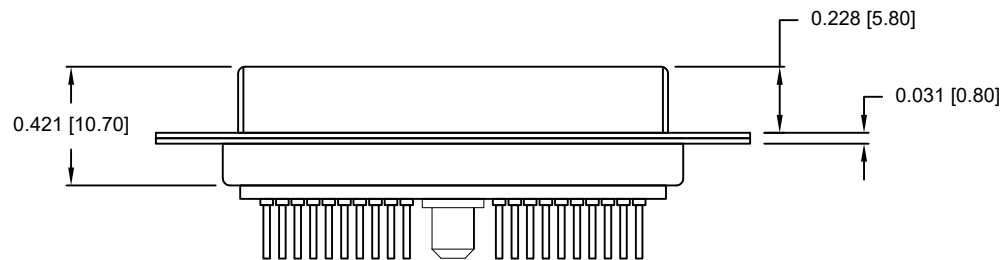
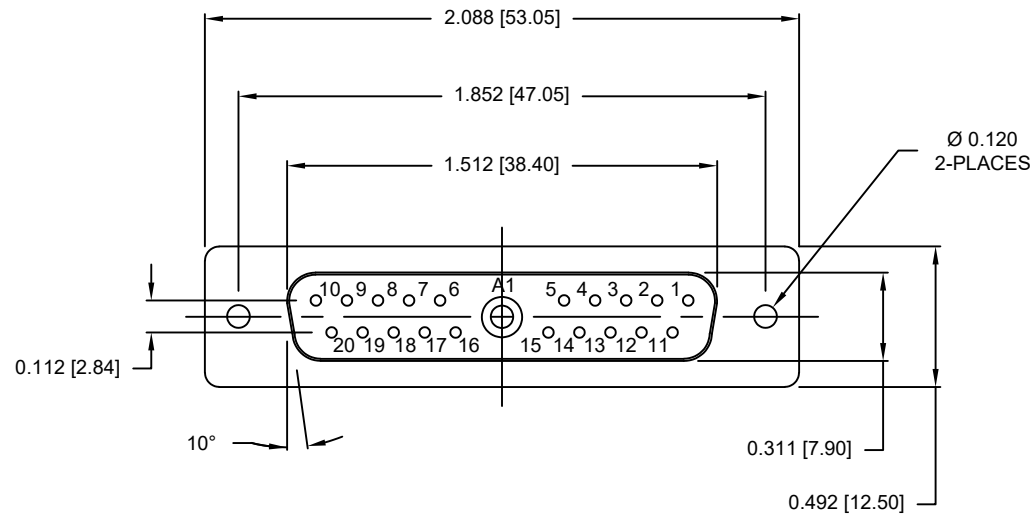

SEE SHEET 2
 FOR CONTACT DIMENSION DETAILS

681M21W1203LYYY

0 = 40 AMP POWER // STANDARD PCB TAILS
 1 = 40 AMP POWER // 2.22mm PCB TAILS
 2 = 20 AMP POWER // STANDARD PCB TAILS

0 = NO HARDWARE
 1 = 0.098" CN PCB SIDE
 2 = 0.236" CN PCB SIDE
 3 = 0.236" CN MATING SIDE
 4 = 0.237" BOARDLOCK PCB SIDE
 5 = 0.224" BOARDLOCK PCB SIDE

1 = GOLD FLASH

RoHS COMPLIANT

UNITS = inches [mm]

DO NOT SCALE FROM DRAWING



THESE DRAWINGS AND SPECIFICATIONS ARE THE PROPERTY OF NorComp AND SHALL NOT BE REPRODUCED, COPIED OR USED AS THE BASIS FOR THE MANUFACTURE OR SALE OF APPARATUS WITHOUT WRITTEN PERMISSION.

DRAWN:
 M. SIGMON

DATE:
 07/19/2013

NorComp

SCALE:
 NTS

SHEET 1 OF 3

REV 4

DWG NO.

681M21W1203LYYY

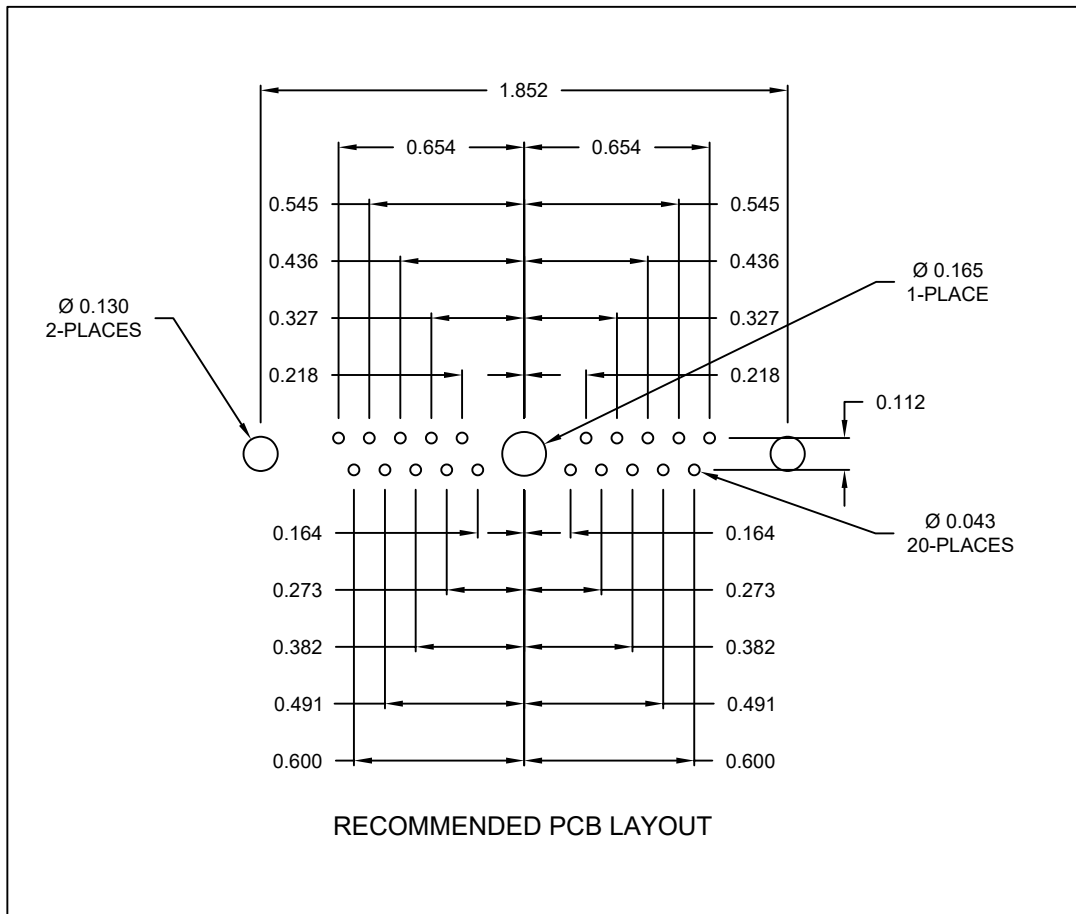

NOTE:
SIGNAL AND POWER CONTACTS
COME PRE-LOADED INTO INSULATORS

DIMENSIONS(in/mm)		
OPTION	S	P
0 & 2	0.218	0.177
	5.55	4.50
1	0.118	0.087
	3.02	2.22

SIGNAL CONTACTS

POWER CONTACTS

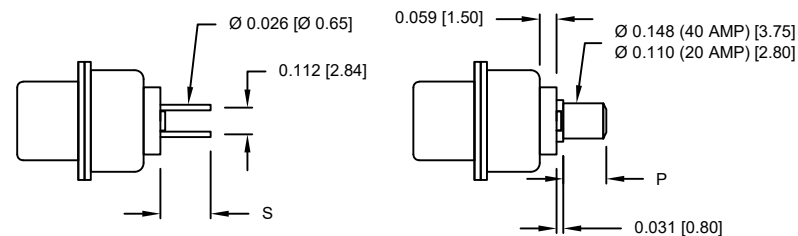

RoHS COMPLIANT

UNITS = inches [mm]

DO NOT SCALE FROM DRAWING



THESE DRAWINGS AND SPECIFICATIONS ARE THE PROPERTY OF NorComp AND SHALL NOT BE REPRODUCED, COPIED OR USED AS THE BASIS FOR THE MANUFACTURE OR SALE OF APPARATUS WITHOUT WRITTEN PERMISSION.

DRAWN:
M. SIGMON

DATE:
07/19/2013

NorComp

SCALE:
NTS

SHEET 2 OF 3

REV 4

DWG NO.

681M21W1203LYYY

ALL CLINCH-NUTS ARE 4-40 INTERNAL THREADS

TOLERANCE:
ALL DIMENSIONS ARE ±0.010

0 NO HARDWARE

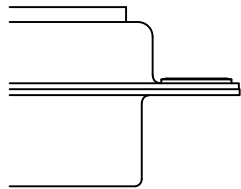

2 0.236" PCB SIDE

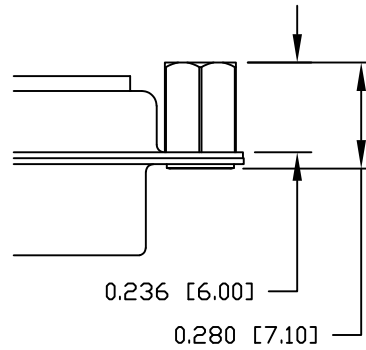

4 0.237" PCB SIDE

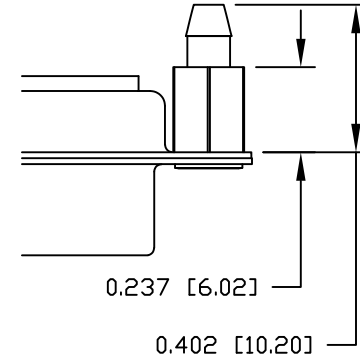

1 0.098" PCB SIDE

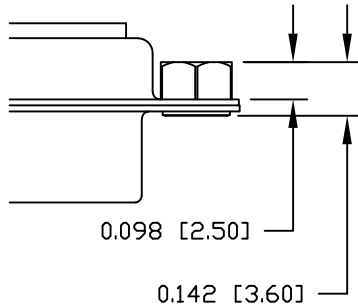

3 0.236" MATING SIDE

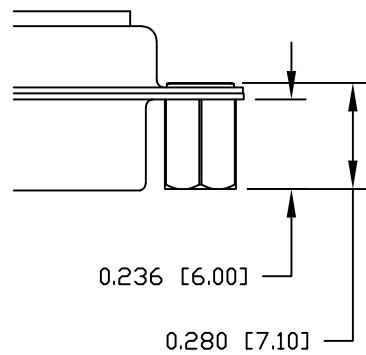

5 0.224" PCB SIDE

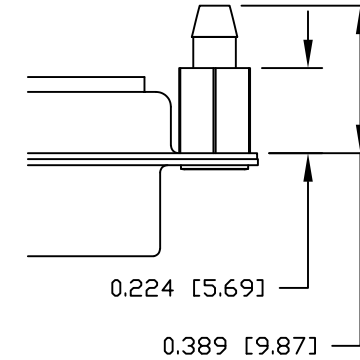

RoHS COMPLIANT

UNITS = inches [mm] DO NOT SCALE FROM DRAWING



THESE DRAWINGS AND SPECIFICATIONS ARE THE PROPERTY OF NorComp AND SHALL NOT BE REPRODUCED, COPIED OR USED AS THE BASIS FOR THE MANUFACTURE OR SALE OF APPARATUS WITHOUT WRITTEN PERMISSION.

DRAWN:
M. SIGMON

DATE:
07/19/2013

NorComp

SCALE:
NTS

SHEET 3 OF 3

REV 4

DWG NO.

681M21W1203LYYY