

**Data sheet | Item number: 832-1206/334-000**

1-conductor male connector; lever; Push-in CAGE CLAMP®; 16 mm<sup>2</sup>; Pin spacing 10.16 mm; 6-pole; 100% protected against mismatching; Strain relief plate; Silver-plated contacts; 16,00 mm<sup>2</sup>; light gray



[www.wago.com/832-1206/334-000](http://www.wago.com/832-1206/334-000)



Subject to changes. Please also observe the further product documentation!

WAGO GmbH & Co. KG  
Hansastr. 27  
32423 Minden  
Phone: +49571 887-0 | Fax: +49571 887-169  
Email: [info.de@wago.com](mailto:info.de@wago.com) | Web: [www.wago.com](http://www.wago.com)

Do you have any questions about our products?  
We are always happy to take your call at +49 (571) 887-44222.

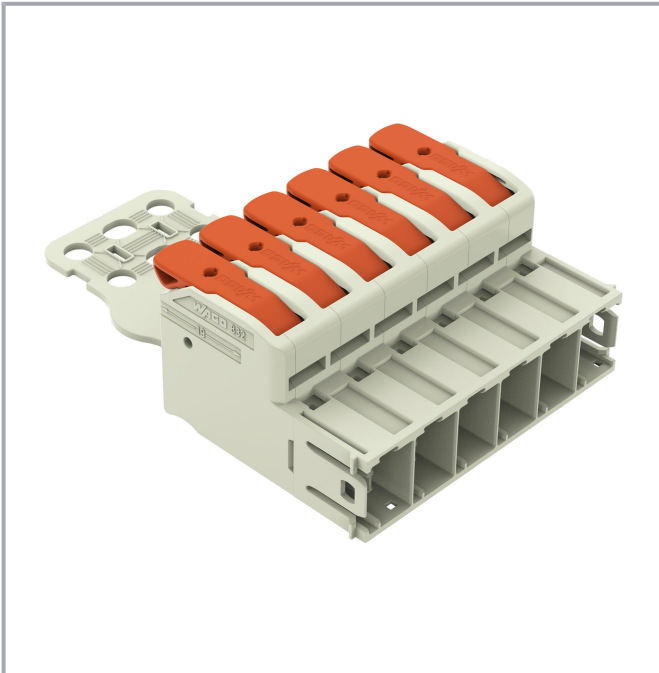

### Derating Curve

1-conductor female connector (832-1102) with  
1-conductor male connector (832-1202)

Pin spacing: 10.16 mm / Conductor cross-section: 25 mm<sup>2</sup> "f-st"

Based on: EN 60512-5-2 / Reduction factor: 0.8

Current in A

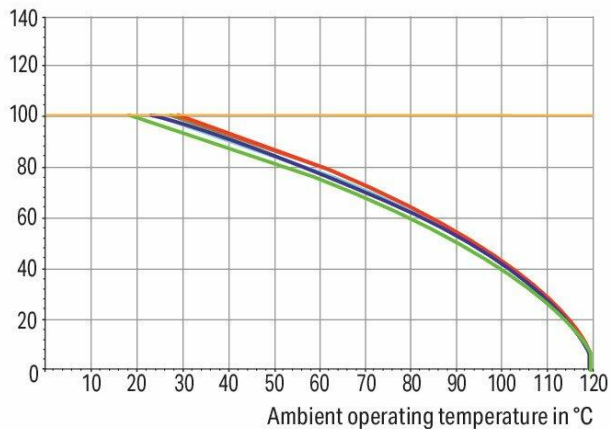

2-, 3-, 4-, 5-, 6- pole

Conductor rated current

### Derating Curve

1-conductor female connector (832-1102) with  
1-conductor male connector (832-1202)

Pin spacing: 10.16 mm / Conductor cross-section: 16 mm<sup>2</sup> "f-st"

Based on: EN 60512-5-2 / Reduction factor: 0.8

Current in A

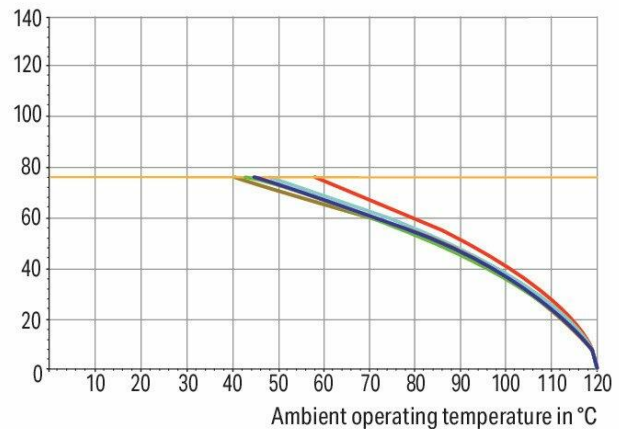

2-, 3-, 4-, 5-, 6- pole

Conductor rated current

Subject to changes. Please also observe the further product documentation!

WAGO GmbH & Co. KG

Hansastr. 27

32423 Minden

Phone: +49571 887-0 | Fax: +49571 887-169

Email: [info.de@wago.com](mailto:info.de@wago.com) | Web: [www.wago.com](http://www.wago.com)

Do you have any questions about our products?

We are always happy to take your call at +49 (571) 887-44222.

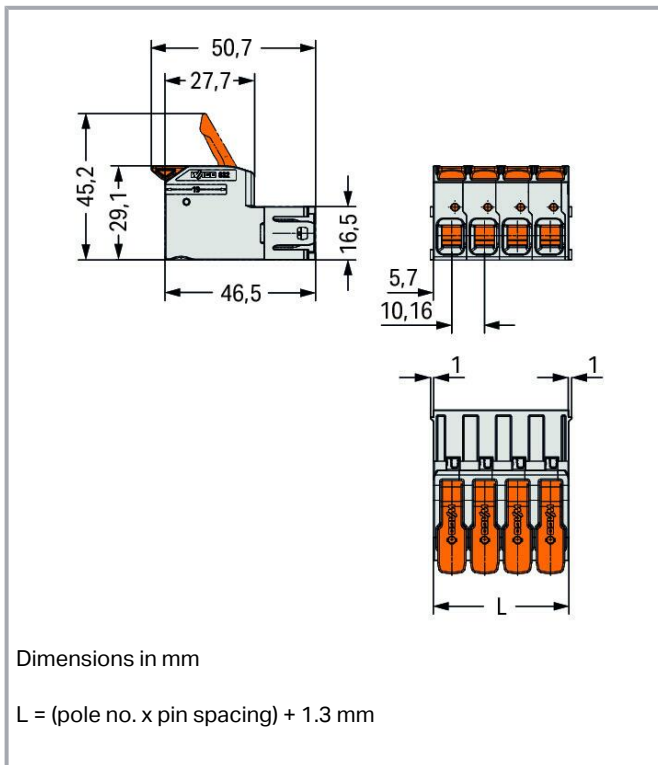

## Item description

- Intuitive and tool-free lever actuation
- Universal connection for all conductor types
- Push-in termination of solid or ferruled conductors
- Test slot 0° and 90° to conductor entry
- 100% protected against mismatching
- Coding option available

## Data

### Notes

#### Safety information

The *MCS – MULTI CONNECTION SYSTEM* includes connectors without breaking capacity in accordance with DIN EN 61984. When used as intended, these connectors must not be connected /disconnected when live or under load. When used as intended, these connectors must not be connected/disconnected when live or under load. The circuit design should ensure header pins, which can be touched, are not live when unmated.

#### Variants:

Other pole numbers

Subject to changes. Please also observe the further product documentation!

Other versions (or variants) can be requested from WAGO Sales or configured at <https://configurator.wago.com/>.

## Electrical data

### Ratings per IEC/EN

Ratings per	IEC/EN 60664-1
Nominal voltage (III/3)	1000 V
Rated impulse voltage (III/3)	8 kV
Rated voltage (III/2)	1000 V
Rated impulse voltage (III/2)	8 kV
Nominal voltage (II/2)	1000 V
Rated surge voltage (II/2)	8 kV
Rated current	76 A
Legend (ratings)	(III / 2) $\hat{=}$ Overvoltage category III / Pollution degree 2

### Ratings per UL 1059

Approvals per	UL 1059
Rated voltage UL (Use Group B)	600 V
Rated current UL (Use Group B)	66 A
Rated voltage UL (Use Group C)	600 V
Rated current UL (Use Group C)	66 A

### Ratings per UL 1977

Rated voltage (UL 1977)	600 V
Rated current UL 1977	85 A

### Ratings per CSA

Approvals per	CSA
Rated voltage CSA (Use Group B)	600 V
Rated current CSA (Use Group B)	66 A
Rated voltage CSA (Use Group C)	600 V
Rated current CSA (Use Group C)	66 A

## Connection data

Total number of potentials	6
----------------------------	---

Subject to changes. Please also observe the further product documentation!



Number of connection types	1
Number of levels	1

### Connection 1

Connection technology	Push-in CAGE CLAMP®
Actuation type	Lever
Solid conductor	0.75 ... 16 mm <sup>2</sup> / 18 ... 4 AWG
Fine-stranded conductor	0.75 ... 25 mm <sup>2</sup> / 18 ... 4 AWG
Fine-stranded conductor; with insulated ferrule	0.75 ... 16 mm <sup>2</sup>
Fine-stranded conductor; with uninsulated ferrule	0.75 ... 16 mm <sup>2</sup>
Strip length	18 ... 20 mm / 0.71 ... 0.79 inches
Pole number	6
Conductor entry direction to mating direction	0°

### Physical data

Pin spacing	10.16 mm / 0.4 inches
Width	62.26 mm / 2.451 inches
Height	29.1 mm / 1.146 inches
Depth	111.6 mm / 4.394 inches

### Mechanical Data

Variable coding	Yes
Anti-rotation protection	Yes

### Plug-in connection

Contact type (pluggable connector)	Male connector/plug
Connector (connection type)	for conductor
Mismating protection	Yes
Plugging without loss of pin spacing	No
Locking of plug-in connection	none
Strain relief	Strain relief plate

### Material Data

Note (material data)

[Information on material specifications can be found here](#)

Subject to changes. Please also observe the further product documentation!



Color	light gray
Material group	I
Insulation material	Polybutylene terephthalate (PBT)
Flammability class per UL94	V0
Clamping spring material	Chrome-nickel spring steel (CrNi)
Contact material	Electrolytic copper (E <sub>Cu</sub> )
Contact plating	Silver
Fire load	1.547 MJ
Actuator color	orange
Weight of insulation material	31.36 g
Weight	79.2 g

### Environmental requirements

Limit temperature range	-60 ... +120 °C
Processing temperature	-35 ... +60 °C

### Commercial data

ETIM 8.0	EC001284
ETIM 7.0	EC001284
PU (SPU)	5 pcs
Packaging type	box
Country of origin	DE
GTIN	4055143938198
Customs tariff number	85366990990

### Environmental Product Compliance

RoHS Compliance Status	Compliant, No Exemption
------------------------	-------------------------





### Approvals / Certificates

#### General approvals

Logo	Approval	Additional Approval Text	Certificate name
	UL Underwriters Laboratories Inc.	C22.2 No. 158	E45172

Subject to changes. Please also observe the further product documentation!

## Counterpart

	<b>Item no. 832-1106</b> 1-conductor female connector; lever; Push-in CAGE CLAMP®; 16 mm <sup>2</sup> ; Pin spacing 10.16 mm; 6-pole; 100% protected against mismatching; Silver-plated contacts; 16,00 mm <sup>2</sup> ; light gray	<a href="http://www.wago.com/832-1106">www.wago.com/832-1106</a>
	<b>Item no. 832-1106/344-000</b> 1-conductor female connector; lever; Push-in CAGE CLAMP®; 16 mm <sup>2</sup> ; Pin spacing 10.16 mm; 6-pole; 100% protected against mismatching; Centered locking levers; Strain relief plate; Silver-plated contacts; 16,00 mm <sup>2</sup> ; light gray	<a href="http://www.wago.com/832-1106/344-000">www.wago.com/832-1106/344-000</a>
	<b>Item no. 832-1106/314-000</b> 1-conductor female connector; lever; Push-in CAGE CLAMP®; 16 mm <sup>2</sup> ; Pin spacing 10.16 mm; 6-pole; 100% protected against mismatching; Lateral locking levers; Strain relief plate; Silver-plated contacts; 16,00 mm <sup>2</sup> ; light gray	<a href="http://www.wago.com/832-1106/314-000">www.wago.com/832-1106/314-000</a>
	<b>Item no. 832-1106/334-000</b> 1-conductor female connector; lever; Push-in CAGE CLAMP®; 16 mm <sup>2</sup> ; Pin spacing 10.16 mm; 6-pole; 100% protected against mismatching; Strain relief plate; Silver-plated contacts; 16,00 mm <sup>2</sup> ; light gray	<a href="http://www.wago.com/832-1106/334-000">www.wago.com/832-1106/334-000</a>

## Optional accessories





### Mounting

#### Mounting accessories

	<b>Item no.: 832-300</b> Locking device; for feed-through mounting; 2 parts; light gray	<a href="http://www.wago.com/832-300">www.wago.com/832-300</a>
--	--	--

### Ferrule

#### Ferrule

	<b>Item no.: 216-210</b> Ferrule; Sleeve for 16 mm <sup>2</sup> / AWG 6; insulated; electro-tin plated; electrolytic copper; gastight crimped; acc. to DIN 46228, Part 4/09.90; blue	<a href="http://www.wago.com/216-210">www.wago.com/216-210</a>
	<b>Item no.: 216-284</b> Ferrule; Sleeve for 1.5 mm <sup>2</sup> / AWG 16; insulated; electro-tin plated; electrolytic copper; gastight crimped; acc. to DIN 46228, Part 4/09.90; black	<a href="http://www.wago.com/216-284">www.wago.com/216-284</a>
	<b>Item no.: 216-286</b> Ferrule; Sleeve for 2.5 mm <sup>2</sup> / AWG 14; insulated; electro-tin plated; electrolytic copper; gastight crimped; acc. to DIN 46228, Part 4/09.90; blue	<a href="http://www.wago.com/216-286">www.wago.com/216-286</a>
	<b>Item no.: 216-287</b> Ferrule; Sleeve for 4 mm <sup>2</sup> / AWG 12; insulated; electro-tin plated; electrolytic copper; gastight crimped; acc. to DIN 46228, Part 4/09.90; gray	<a href="http://www.wago.com/216-287">www.wago.com/216-287</a>
	<b>Item no.: 216-288</b> Ferrule; Sleeve for 6 mm <sup>2</sup> / AWG 10; insulated; electro-tin plated; electrolytic copper; gastight crimped; acc. to DIN 46228, Part 4/09.90; yellow	<a href="http://www.wago.com/216-288">www.wago.com/216-288</a>
	<b>Item no.: 216-289</b>	

Subject to changes. Please also observe the further product documentation!



Ferrule; Sleeve for 10 mm<sup>2</sup> / AWG 8; insulated; electro-tin plated; electrolytic copper; gastight crimped; [www.wago.com/216-289](http://www.wago.com/216-289)  
acc. to DIN 46228, Part 4/09.90; red

### Coding

Coding



Item no.: 832-500  
Coding key carrier; orange

[www.wago.com/832-500](http://www.wago.com/832-500)

## Downloads

### Documentation

#### Additional Information

Technical Section	2019 Apr 3	pdf	Download
Technical explanations		2.0 MB	

## Environmental Product Compliance

### Compliance Search

Environmental Product Compliance 832-1206/334-000	URL	Download
1-conductor male connector; lever; Push-in CAGE CLAMP®; 16 mm <sup>2</sup> ; Pin spacing 10.16 mm; 6-pole; 100% protected against mismatching; Strain relief plate; Silver-plated contacts; 16,00 mm <sup>2</sup> ; light gray		

## Installation Notes

### Conductor termination



Fine-stranded wires, connected

### Conductor termination

Subject to changes. Please also observe the further product documentation!



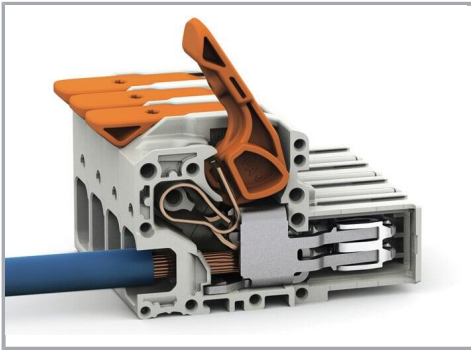

Insert fine-stranded conductors – and remove all conductors – via operating tool.

### Product family

*MCS* MAXI 16

[Show all products from the family](#)

Subject to changes. Please also observe the further product documentation!