

Auxiliary Switch Diodes for Snubber SARS01, SARS02, SARS05, SARS10

Data Sheet

Description

The SARS⁽¹⁾ is an auxiliary switch diode especially designed for snubber circuits, which are used in the primary sides of flyback switched-mode power supplies.

Being capable of reducing the ringing voltage generated at power MOSFET turn-off, the SARS-incorporated snubber circuits allow better cross regulation of multiple outputs.

The SARS can also improve power supply efficiency by partially transferring such ringing voltage into the secondary side of a power supply unit.

Features

- Improves Cross Regulation
- Reduces Noise
- Improves Efficiency

Applications

For switched-mode power supplies (SMPS) with flyback topology such as:

- White Goods
- Adaptor
- Industrial Equipment

Typical Application

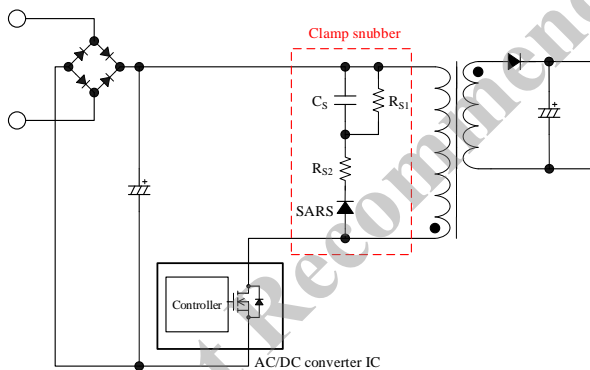

Package

SARS01 (Axial ϕ 2.7 / ϕ 0.60)



SARS02 (Axial ϕ 4 / ϕ 0.78)



SARS05 (SJP 4.5 mm \times 2.6 mm)

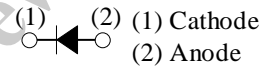
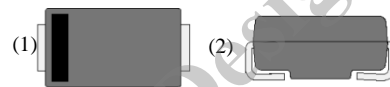

SARS10 (TO220F-2L)

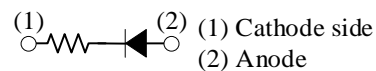
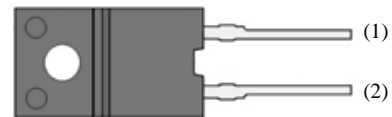

Not to scale

Selection Guide

R_{S2}	Part Number	$I_{F(AV)}$	V_F (max.)	Power Supply Output Power, P_O^*
External Resistor	SARS01	1.2 A	0.92 V	up to 50 W
	SARS02	1.5 A	0.92 V	up to 100 W
	SARS05	1 A	1.05 V	up to 50 W
Built-in 22 Ω	SARS10	0.3 A	13 V	up to 300 W

* P_O represents a reference value for product selection. When using the product, you should monitor temperature rises during actual operation.

⁽¹⁾ The "SARS" represents any one of the SARSxx devices listed in this document.

Contents

Description	1
Contents	2
Absolute Maximum Ratings	3
Electrical Characteristics	4
SARS01 Rating and Characteristic Curves.....	5
SARS02 Rating and Characteristic Curves.....	6
SARS05 Rating and Characteristic Curves.....	8
SARS10 Rating and Characteristic Curves.....	9
Physical Dimensions and Marking Diagram	11
Operating Comparison of Clamp Snubber Circuit	13
Power Dissipation and Junction Temperature Calculation	14
Parameter Setting of Snubber Circuit using SARS	15
Reference Design of Power Supply	16
Important Notes.....	18

Not Recommended for New Designs

SARS01, SARS02, SARS05, SARS10

Absolute Maximum Ratings

Unless otherwise specified, $T_A = 25\text{ }^\circ\text{C}$, only the SARS10 incorporates a resistor ($22\ \Omega$).

Parameter	Symbol	Conditions	Rating	Unit	Remarks
Transient Peak Reverse Voltage	V_{RSM}		800	V	
Peak Repetitive Reverse Voltage	V_{RM}		800	V	
Average Forward Current ⁽²⁾	$I_{F(AV)}$		1.2	A	SARS01
			1.2		SARS02
			1.0		SARS05
			0.3		SARS10
Surge Forward Current	I_{FSM}	Half cycle sine wave, positive side, 10 ms, 1 shot	110	A	SARS01
			100		SARS02
			30		SARS05
		1 ms, square pulse, 1 shot	1.5		SARS10
I^2t Limiting Value	I^2t	$1\text{ ms} \leq t \leq 10\text{ ms}$	60.5	A^2s	SARS01
			50		SARS02
			4.5		SARS05
			—		SARS10
Junction Temperature	T_J		-40 to 150	$^\circ\text{C}$	SARS01/02/05
			-20 to 125		SARS10
Storage Temperature	T_{STG}		-40 to 150	$^\circ\text{C}$	SARS01/02/05
			-20 to 125		SARS10
Power Dissipation	P		3.0	W	SARS10

⁽²⁾ See the derating curves of each product.

SARS01, SARS02, SARS05, SARS10

Electrical Characteristics

Unless otherwise specified, $T_A = 25\text{ }^\circ\text{C}$, only the SARS10 incorporates a resistor ($22\text{ }\Omega$).

Parameter	Symbol	Conditions	Min.	Typ.	Max.	Unit	Remarks
Forward Voltage Drop	V_F	$I_F = 1.2\text{ A}$	—	—	0.92	V	SARS01
		$I_F = 1.5\text{ A}$	—	—	0.92		SARS02
		$I_F = 1.0\text{ A}$	—	—	1.05		SARS05
		$I_F = 0.5\text{ A}$	—	—	13		SARS10
Reverse Leakage Current	I_R	$V_R = V_{RM}$	—	—	10	μA	SARS01
			—	—	10		SARS02
			—	—	5		SARS05
			—	—	10		SARS10
Reverse Leakage Current under High Temperature	$H \cdot I_R$	$V_R = V_{RM}$, $T_J = 100\text{ }^\circ\text{C}$	—	—	50	μA	SARS01/02/05
		$V_R = V_{RM}$, $T_J = 125\text{ }^\circ\text{C}$	—	—	100		SARS10
Reverse Recovery Time	t_{rr}	$I_F = I_{RP} = 100\text{ mA}$, $T_J = 25\text{ }^\circ\text{C}$, 90% recovery point	2	—	18	μs	SARS01
			2	—	18		SARS02
			2	—	19		SARS05
			1	—	9		SARS10
Thermal Resistance	$R_{th(J-L)}$	⁽³⁾	—	—	20	$^\circ\text{C/W}$	SARS01
			—	—	15		SARS02
			—	—	20		SARS05
	$R_{th(J-C)}$	⁽⁴⁾	—	—	15	$^\circ\text{C/W}$	SARS10

⁽³⁾ $R_{th(J-L)}$ is thermal resistance between junction and lead.

⁽⁴⁾ $R_{th(J-C)}$ is thermal resistance between junction and case.

SARS01 Rating and Characteristic Curves

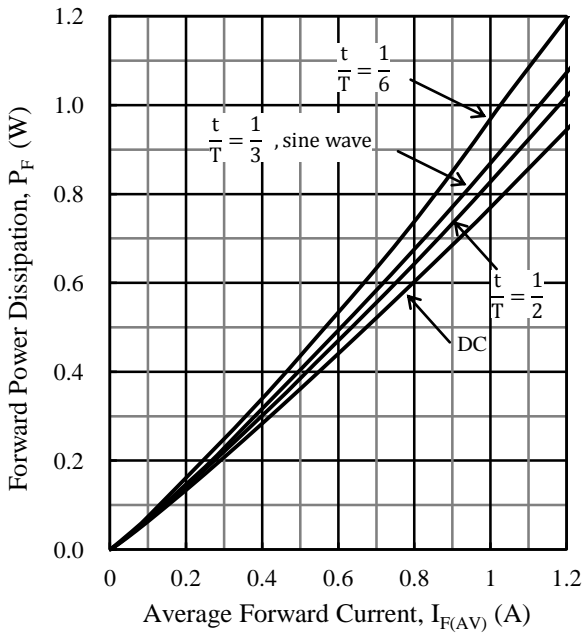

Figure 1. $I_{F(AV)}$ vs. P_F Power Dissipation Curves ($T_J = 150\text{ }^\circ\text{C}$)

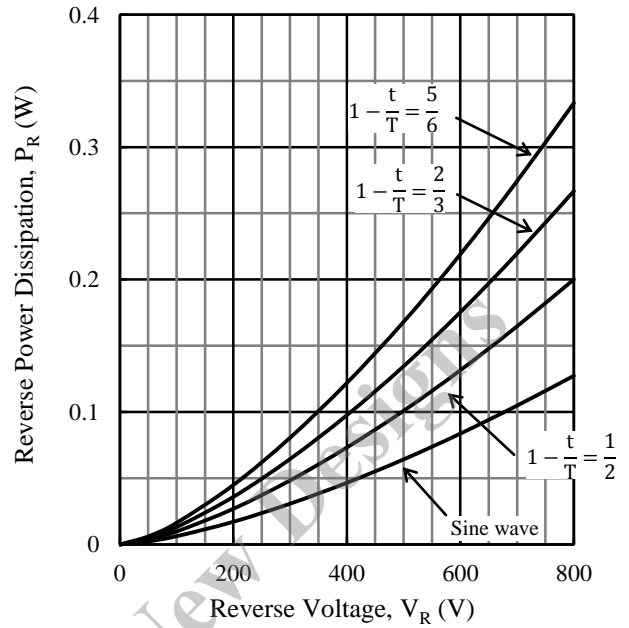

Figure 2. V_R vs. P_R Power Dissipation Curves ($T_J = 150\text{ }^\circ\text{C}$)

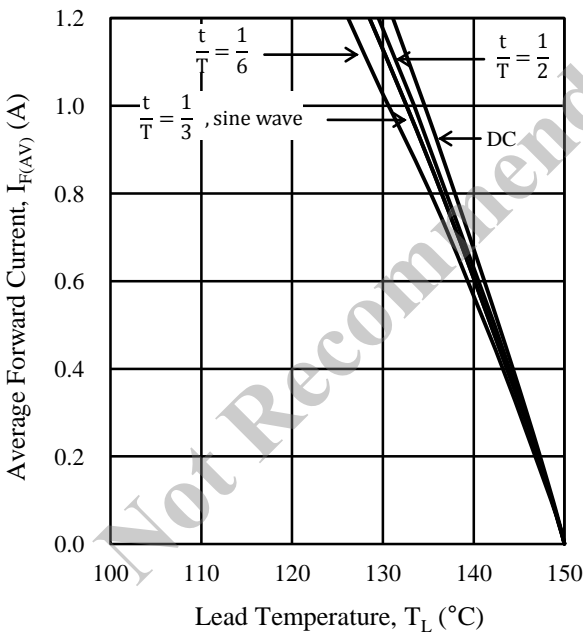

Figure 3. T_L vs. $I_{F(AV)}$ Derating Curves ($V_R = 0\text{ V}$, $T_J = 150\text{ }^\circ\text{C}$)

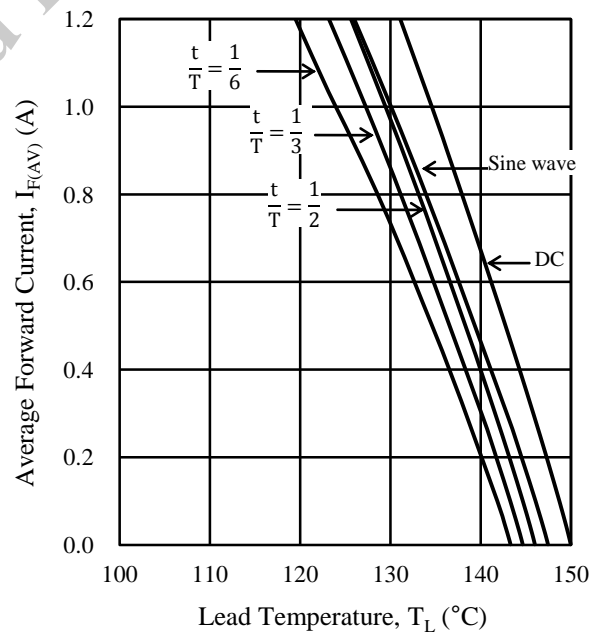

Figure 4. T_L vs. $I_{F(AV)}$ Derating Curves ($V_R = 800\text{ V}$, $T_J = 150\text{ }^\circ\text{C}$)

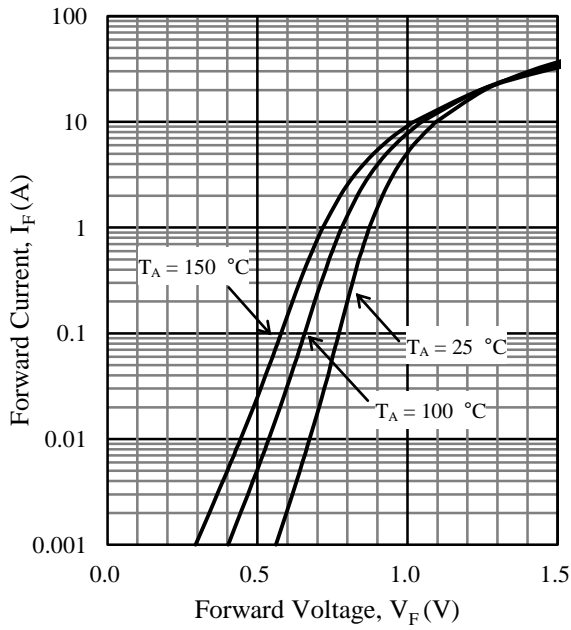

Figure 5. V_F vs. I_F Typical Characteristics

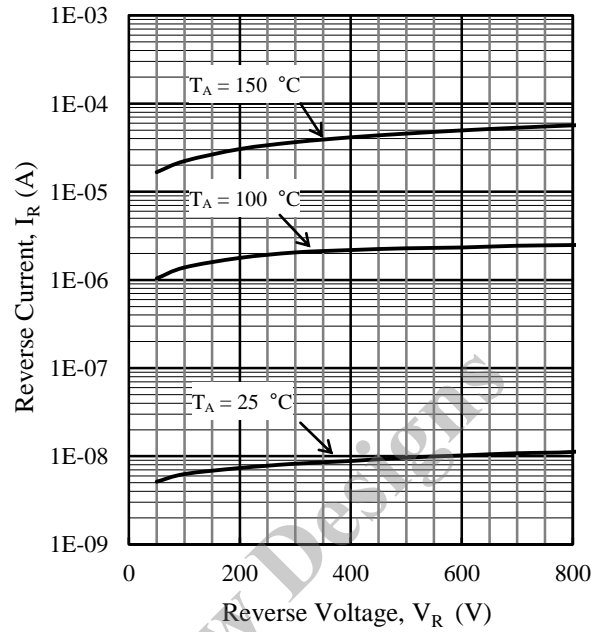

Figure 6. V_R vs. I_R Typical Characteristics

SARS02 Rating and Characteristic Curves

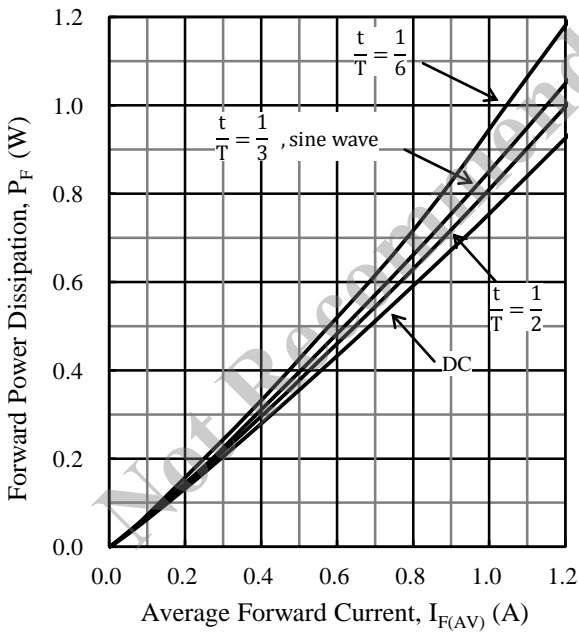

Figure 7. $I_{F(AV)}$ vs. P_F Power Dissipation Curves ($T_J = 150\text{ °C}$)

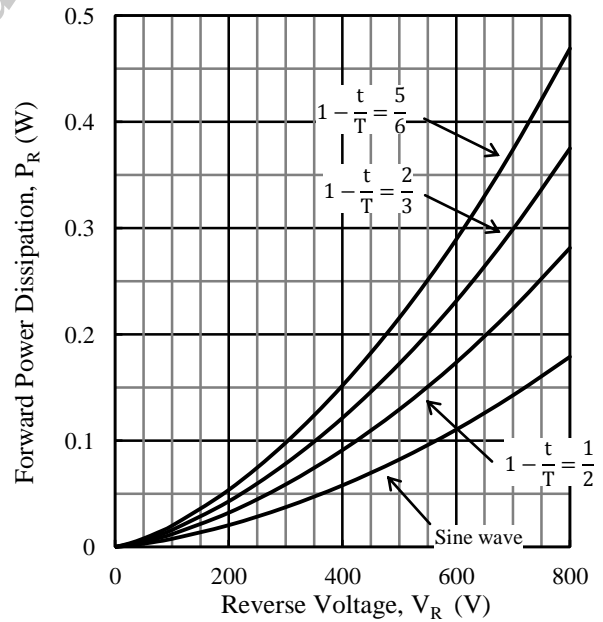

Figure 8. V_R vs. P_R Power Dissipation Curves ($T_J = 150\text{ °C}$)

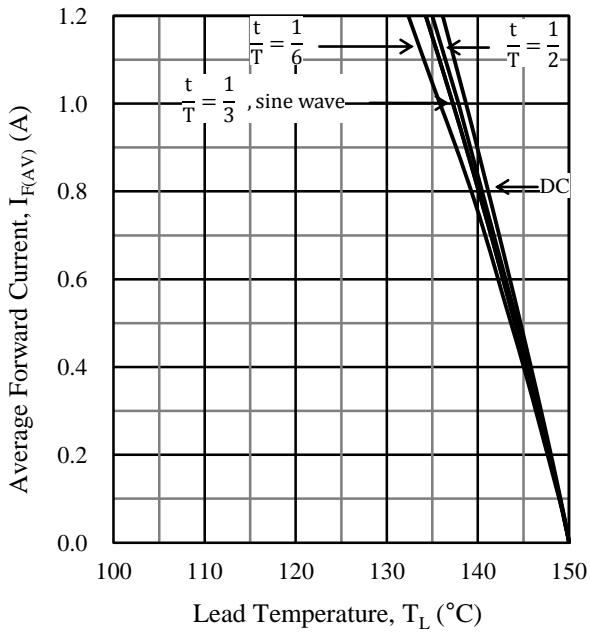

Figure 9. T_L vs. $I_{F(AV)}$ Derating Curves
($V_R = 0$ V, $T_J = 150$ °C)

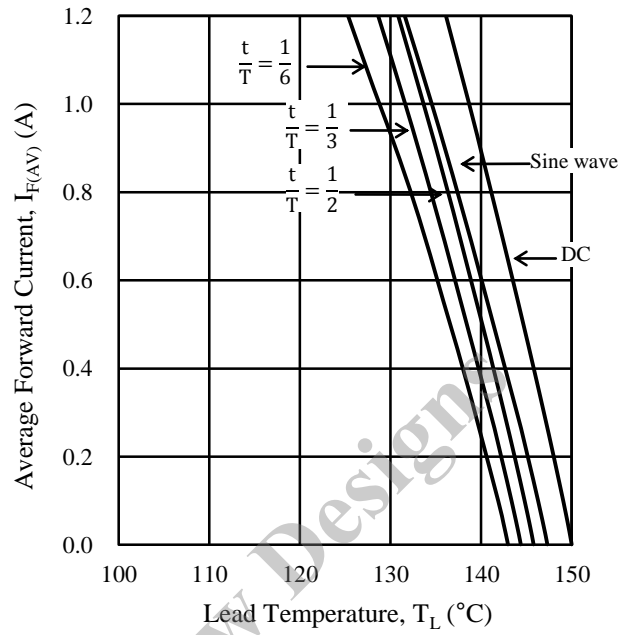

Figure 10. T_L vs. $I_{F(AV)}$ Derating Curves
($V_R = 800$ V, $T_J = 150$ °C)

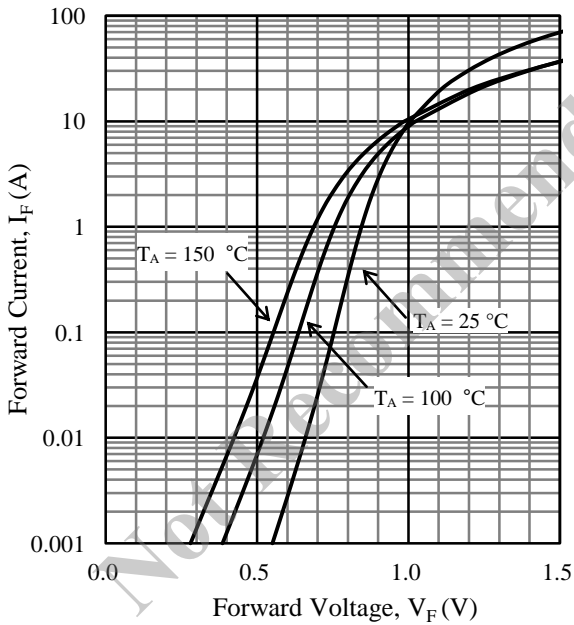

Figure 11. V_F vs. I_F Typical Characteristics

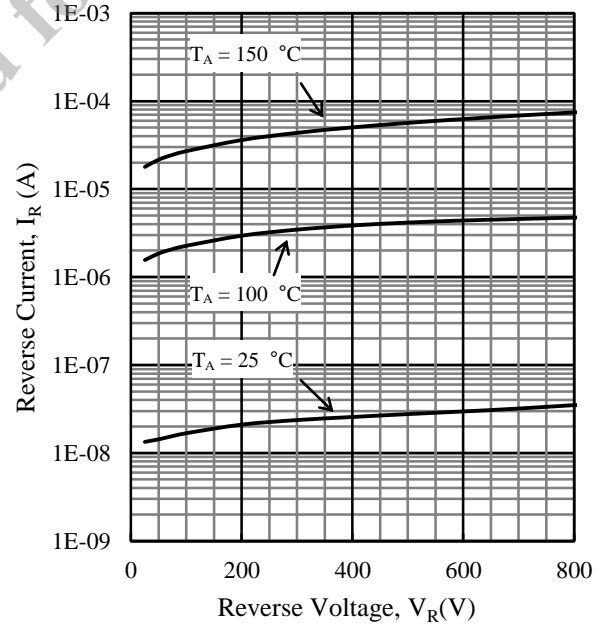

Figure 12. V_R vs. I_R Typical Characteristics

SARS05 Rating and Characteristic Curves

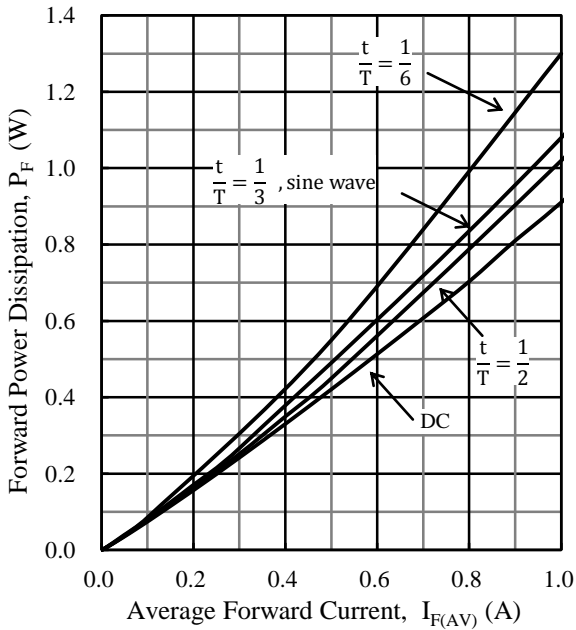

Figure 13. $I_{F(AV)}$ vs. P_F Power Dissipation Curves ($T_J = 150\text{ }^\circ\text{C}$)

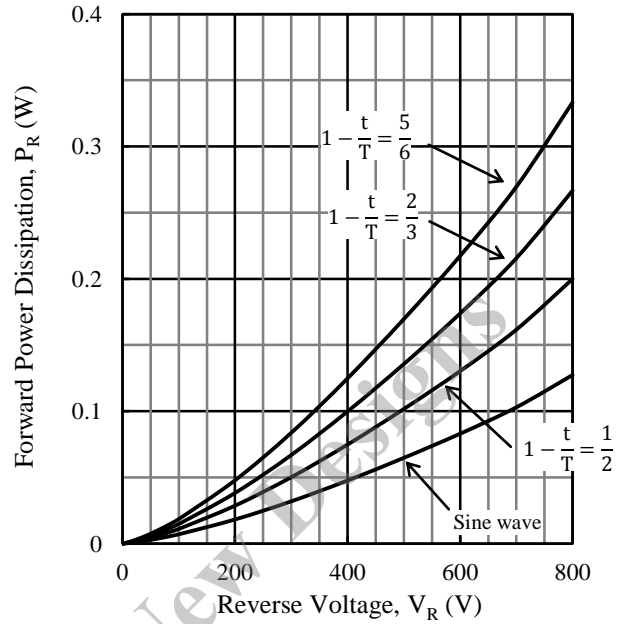

Figure 14. V_R vs. P_R Power Dissipation Curves ($T_J = 150\text{ }^\circ\text{C}$)

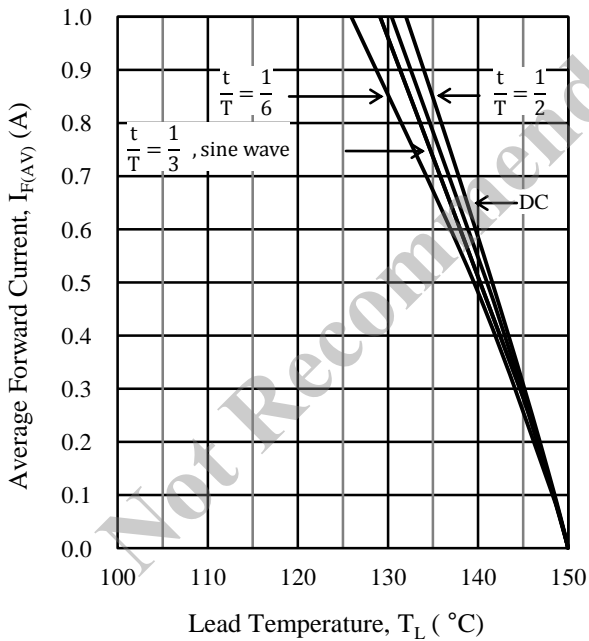

Figure 15. T_L vs. $I_{F(AV)}$ Derating Curves ($V_R = 0\text{ V}$, $T_J = 150\text{ }^\circ\text{C}$)

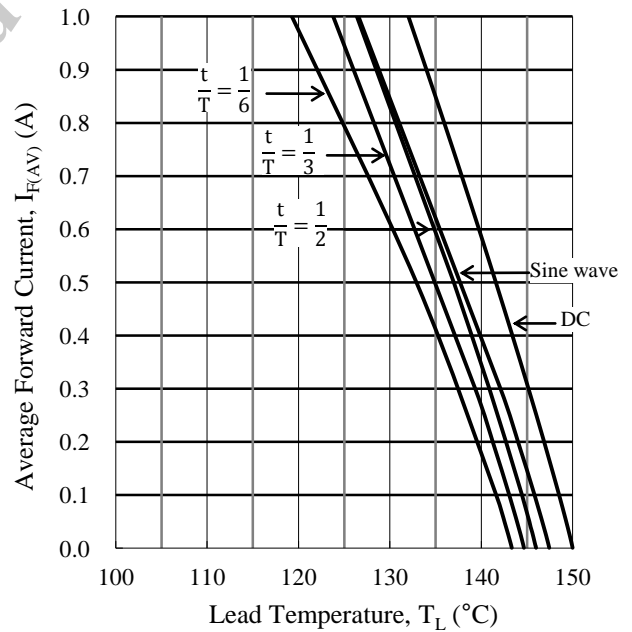

Figure 16. T_L vs. $I_{F(AV)}$ Derating Curves ($V_R = 800\text{ V}$, $T_J = 150\text{ }^\circ\text{C}$)

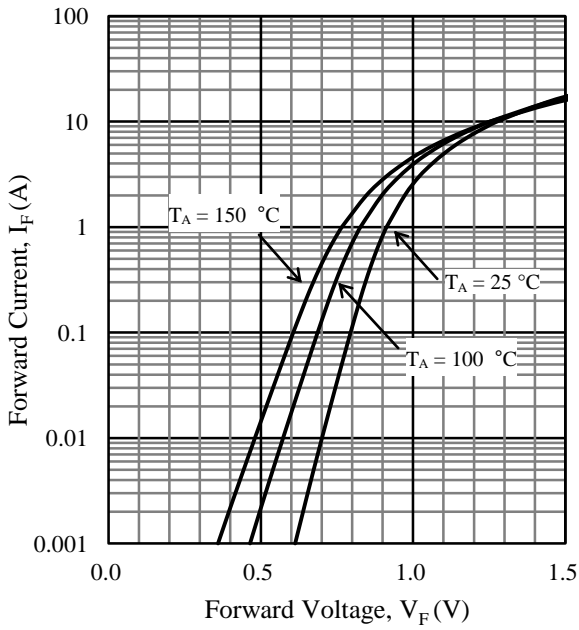

Figure 17. V_F vs. I_F Typical Characteristics

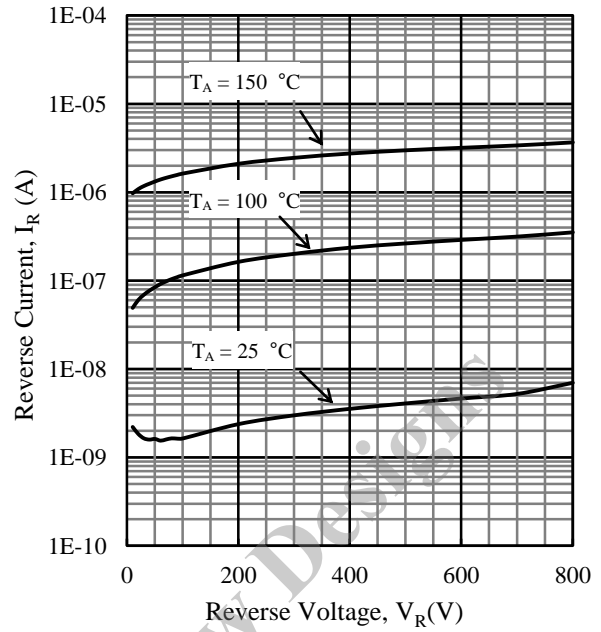

Figure 18. V_R vs. I_R Typical Characteristics

SARS10 Rating and Characteristic Curves

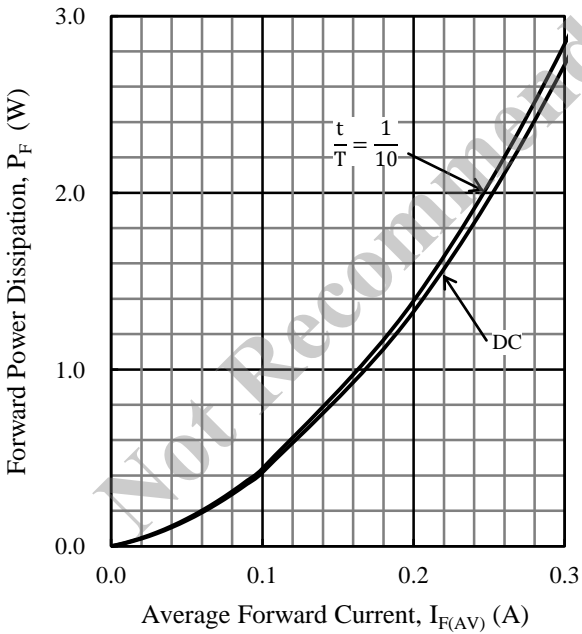

Figure 19. $I_{F(AV)}$ vs. P_F Power Dissipation Curves ($T_J = 125\text{ °C}$)

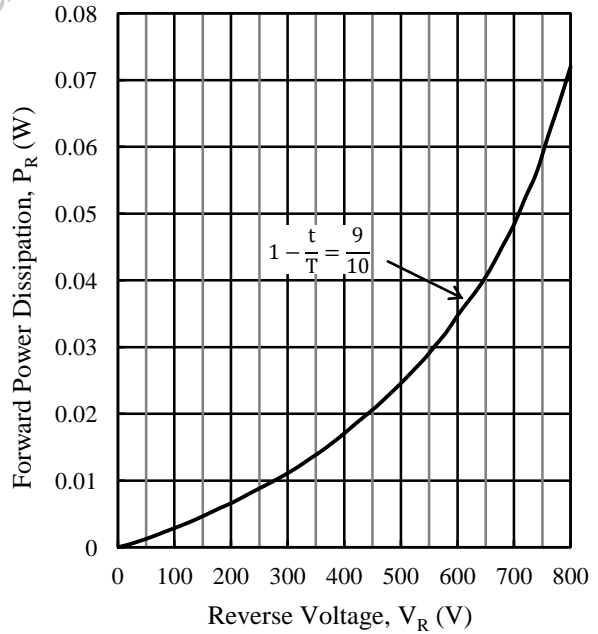

Figure 20. V_R vs. P_R Power Dissipation Curve ($T_J = 125\text{ °C}$)

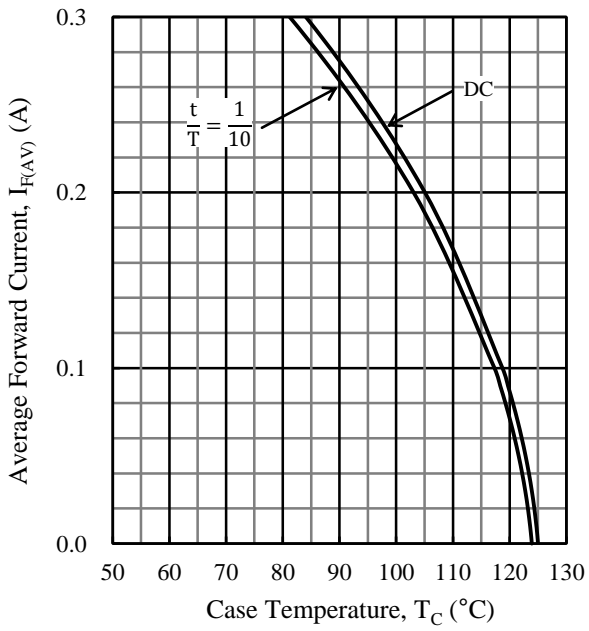

Figure 21. T_C vs. $I_{F(AV)}$ Derating Curves
($V_R = 800\text{ V}$, $T_J = 125\text{ }^\circ\text{C}$)

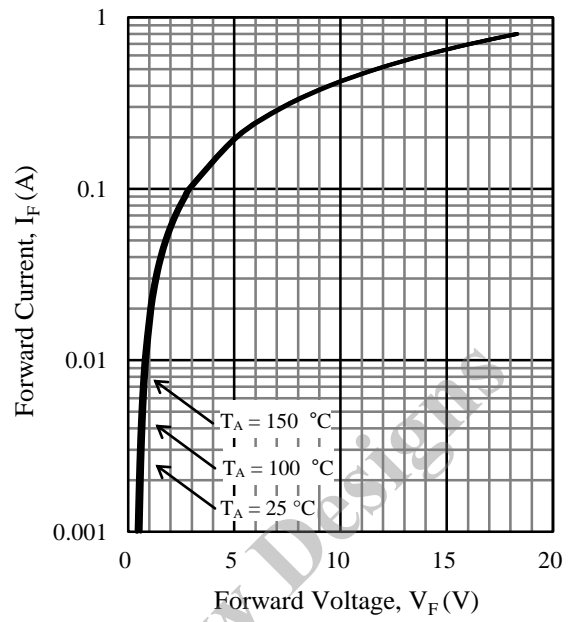

Figure 22. V_F vs. I_F Typical Characteristics

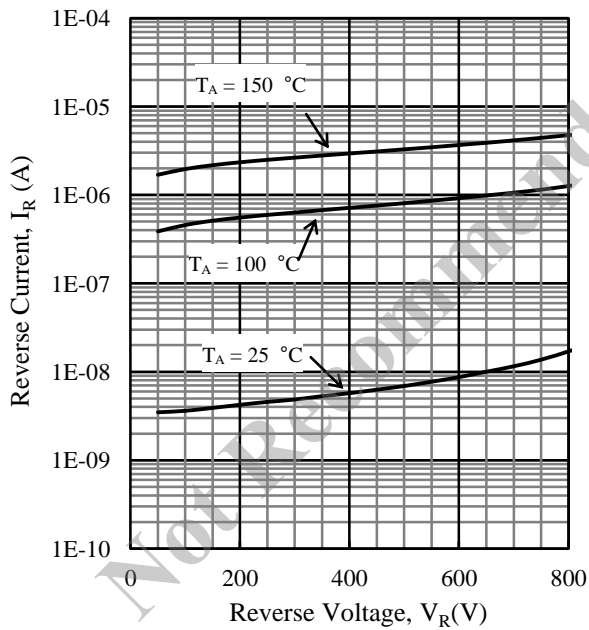

Figure 23. V_R vs. I_R Typical Characteristics

SARS01, SARS02, SARS05, SARS10

Physical Dimensions and Marking Diagrams

• SARS01

Axial (ϕ 2.7 / ϕ 0.6)

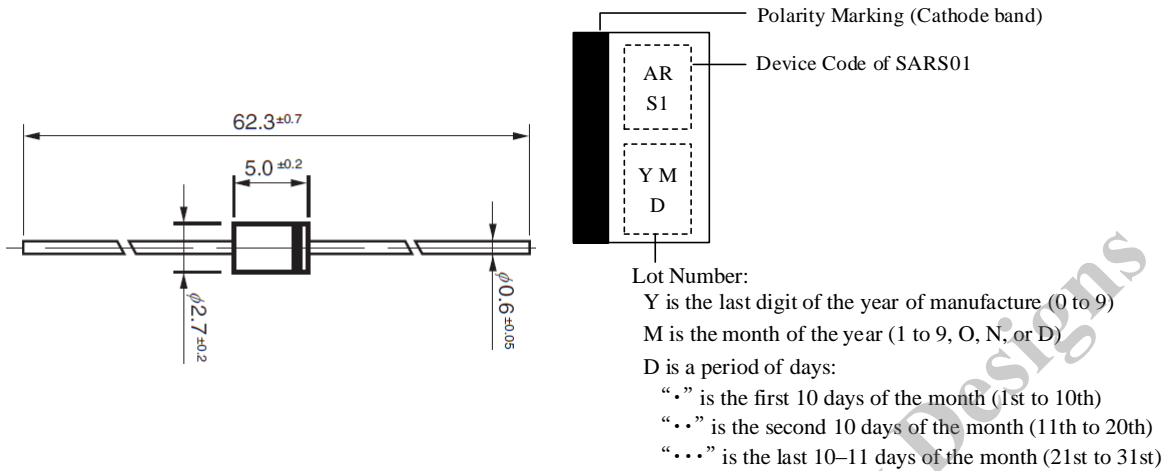

NOTES:

- Dimensions in millimeters
- Bare lead: Pb-free (RoHS compliant)
- When soldering the products, be sure to minimize the working time, within the following limits:
 Flow: 260 ± 5 °C / 10 ± 1 s, 2 times
 Soldering Iron: 380 ± 10 °C / 3.5 ± 0.5 s, 1 time (Soldering should be at a distance of at least 1.5 mm from the body of the products.)

• SARS02

Axial (ϕ 4 / ϕ 0.78)

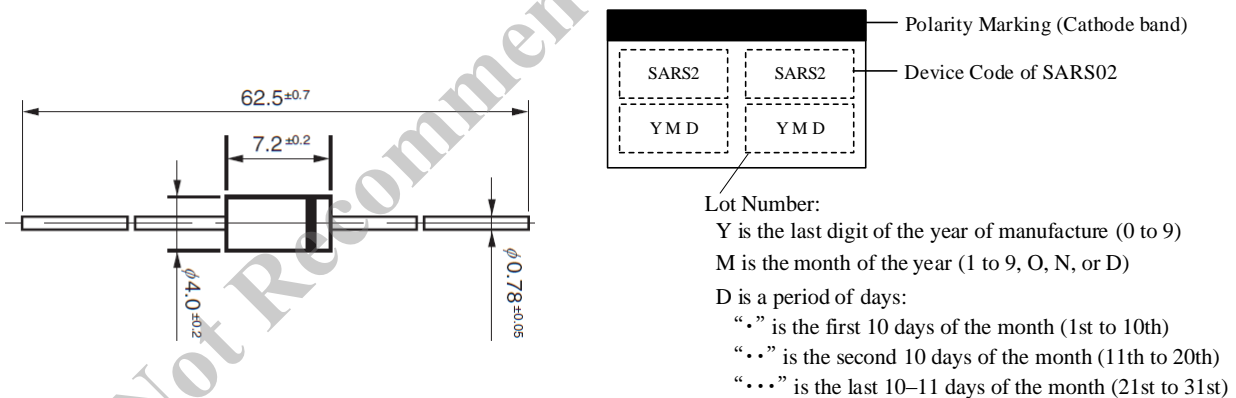

NOTES:

- Dimensions in millimeters
- Bare lead: Pb-free (RoHS compliant)
- When soldering the products, be sure to minimize the working time within the following limits:
 Flow: 260 ± 5 °C / 10 ± 1 s, 2 times
 Soldering iron: 380 ± 10 °C / 3.5 ± 0.5 s, 1 time (Soldering should be at a distance of at least 1.5 mm from the body of the products.)

SARS01, SARS02, SARS05, SARS10

• SARS05

SJP 4.5 mm × 2.6 mm

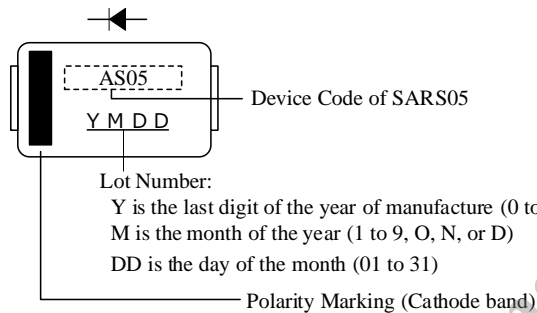
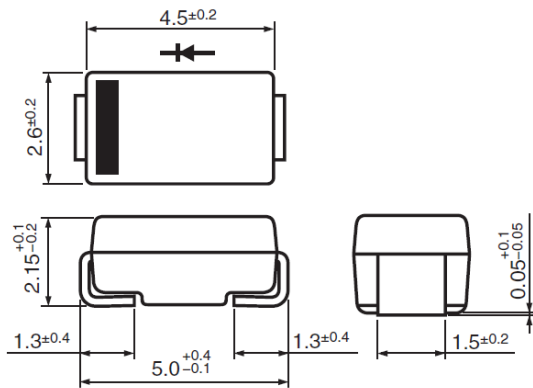

SJP Land Pattern Example

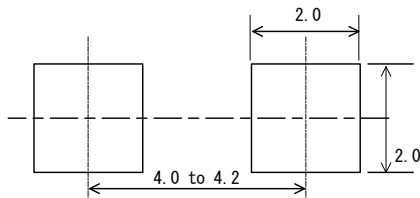

NOTES:

- Dimensions in millimeters
- Bare lead frame: Pb-free (RoHS compliant)
- When soldering the products, be sure to minimize the working time, within the following limits:

Reflow (MSL 1):

Preheat: 180 °C, 90 ± 30 s

Solder heating: 250 °C, 10 ± 1s, 2 times (260 °C peak)

Soldering iron: 380 ± 10 °C, 3.5 ± 0.5s, 1 time

• SARS10

TO220F-2L

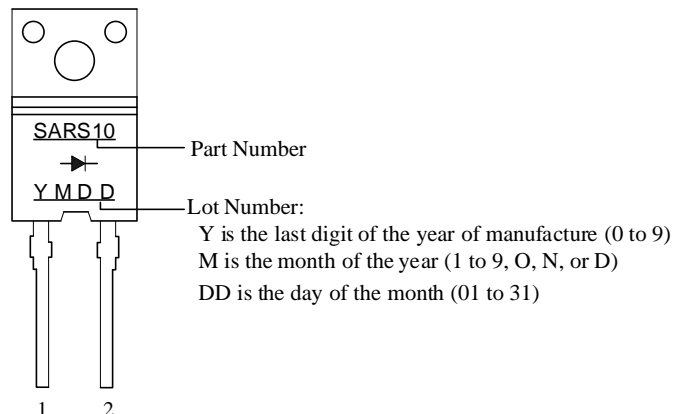
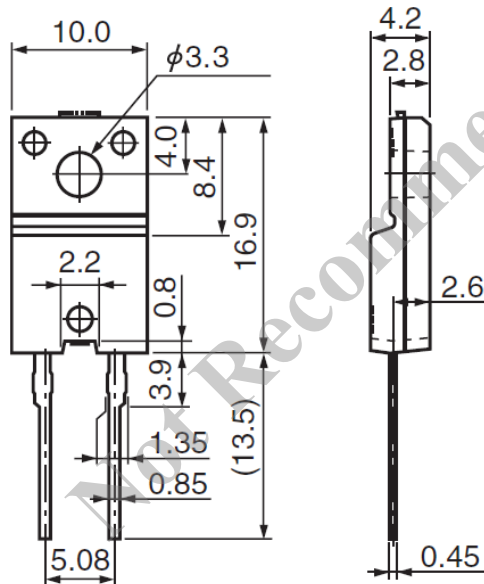

NOTES:

- Dimensions in millimeters
- Bare lead frame: Pb-free (RoHS compliant)
- When soldering the products, be sure to minimize the working time, within the following limits:
 Flow: 260 ± 5 °C / 10 ± 1 s, 2 times
 Soldering Iron: 380 ± 10 °C / 3.5 ± 0.5 s, 1 time (Soldering should be at a distance of at least 1.5 mm from the body of the products.)
- The recommended screw torque for TO220F: 0.490 N·m to 0.686 N·m (5 kgf·cm to 7 kgf·cm)

Operational Comparison of Clamp Snubber Circuits

Figure 24 shows a general clamp snubber circuit. In the circuit, the surge voltage at tuning off a power MOSFET is charged to C_S through the surge absorb loop, and is consumed by R_{S1} through the energy discharge loop. All the consumed energy becomes loss in R_{S1} . In addition, the ringing of surge voltage results in poor cross regulation of multi-outputs.

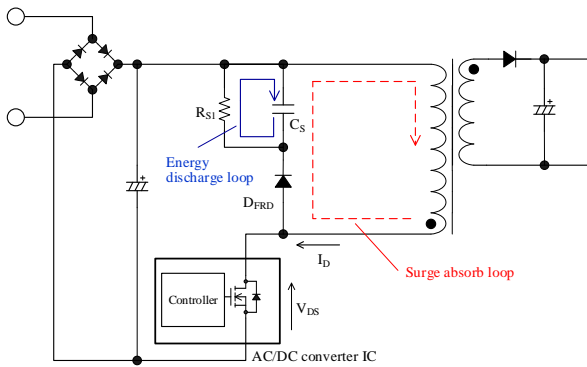

Figure 24. General Clamp Snubber Circuit

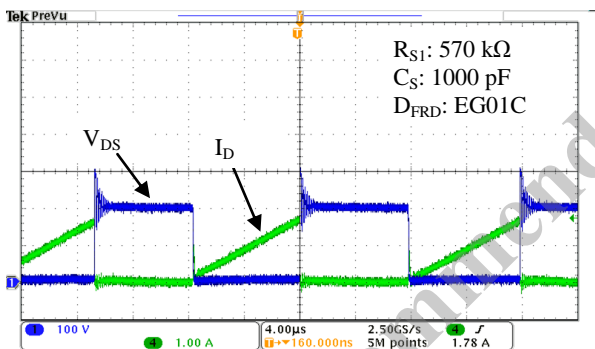

Figure 25. Waveforms of General Clamp Snubber Circuit

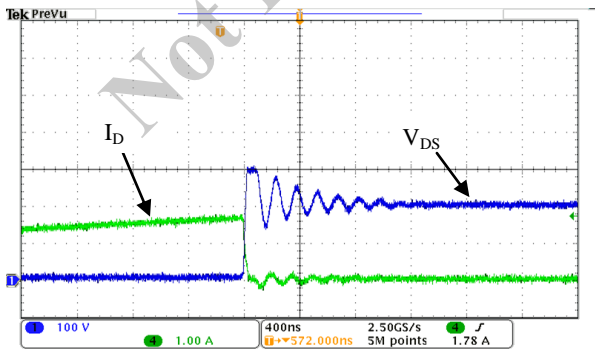

Figure 26. Enlarged View of Figure 25

Figure 27 shows the clamp snubber circuit using the SARS. The surge voltage at tuning off a power MOSFET is charged to C_S through the surge absorb loop. Since the reverse recovery time, t_{rr} , of the SARS is a relatively long period, the energy charged to C_S is discharged to the reverse direction of the surge absorb loop until C_S voltage is equal to the flyback voltage. Thus, the power supply efficiency improves.

In addition, the power supply using the SARS reduces the ringing voltage. Thus, the cross regulation of multi-outputs can be improved.

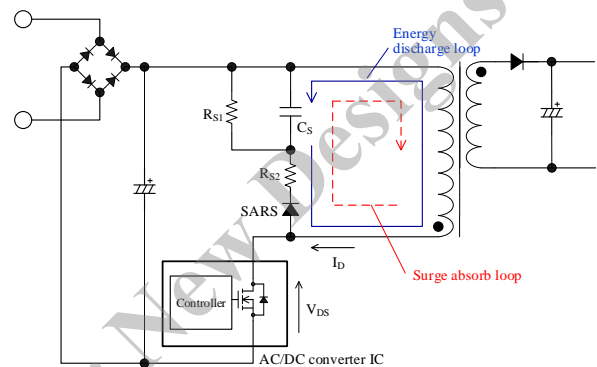

Figure 27. Clamp Snubber Circuit using SARS

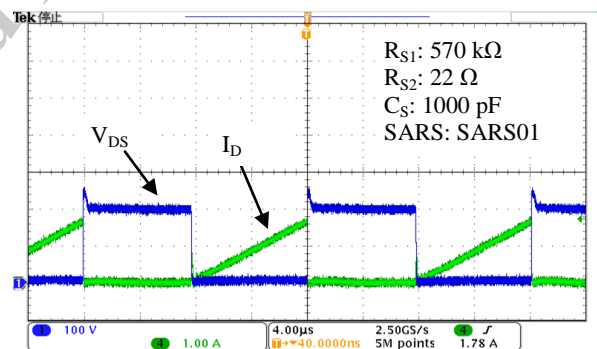

Figure 28. Waveforms of Clamp Snubber Circuit using SARS

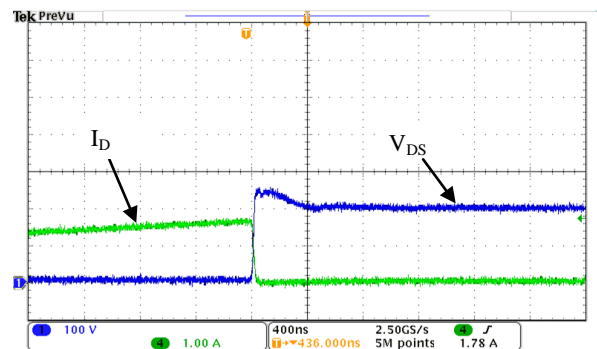

Figure 29. Enlarged View of Figure 28

Power Dissipation and Junction Temperature Calculation

Figure 30 shows a typical application using the SARS. Figure 31 shows the operating waveforms of the SARS.

The power dissipation of the SARS is calculated as follows:

- 1) The waveforms of the SARS voltage, V_{SARS} , and the SARS current, I_{SARS} , are measured in actual application operation. $V_{SARS} \times I_{SARS}$ is calculated by the math function of oscilloscope. (Since the SARS10 incorporates a resistor, $V_{SARS(10)}$ is measured.)
- 2) The each average energy ($P_1, P_2 \dots P_k$) is measured at period of each polarity of $V_{SARS} \times I_{SARS}$ ($t_1, t_2, \dots t_k$) as shown in Figure 30 by the automatic measurement function of the oscilloscope.
- 3) The power dissipation of the SARS, P_{SARS} , is calculated by Equation (1):

$$P_{SARS} = \frac{1}{T} (|P_1 \times t_1| + |P_2 \times t_2| + \dots |P_k \times t_k|) \quad (1)$$

where:

P_{SARS} is power dissipation of the SARS,
 T is switching cycle of power MOSFET (s), and
 P_k is average energy of period t_k (W).

A differential probe is recommended to use for the measurement of V_{SARS} . Please conform to the oscilloscope manual about power dissipation measurement including the delay compensation of probe.

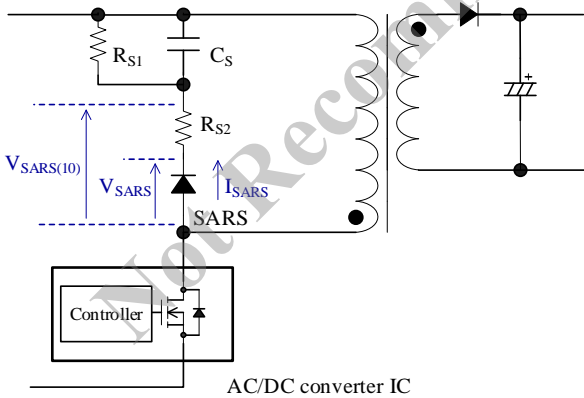

Figure 30. Typical Application

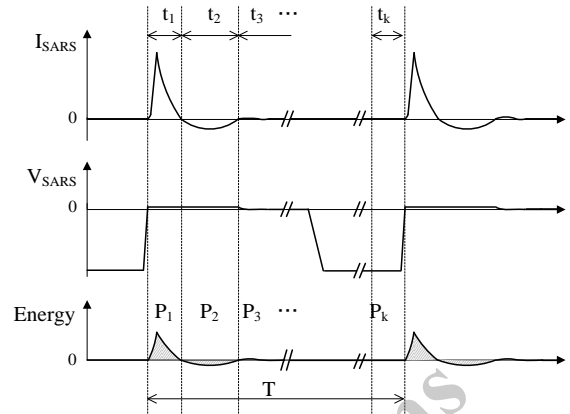

Figure 31. SARS Current

In addition, by using the temperature of the SARS in actual application operation, the estimated junction temperature of the SARS is calculated by Equation (2) and Equation (3). It should be enough lower than T_J of the absolute maximum rating.

• SARS01/02/05

$$T_{J(SARS)} = T_L + \theta_{J-L} \times P_{SARS} \text{ (}^\circ\text{C)} \quad (2)$$

where:

$T_{J(SARS)}$ is junction temperature of the SARS,
 T_L is lead temperature of the SARS, and
 θ_{J-L} is thermal resistance between junction to lead.

• SARS10

$$T_{J(SARS)} = T_C + \theta_{J-C} \times P_{SARS} \text{ (}^\circ\text{C)} \quad (3)$$

Where:

$T_{J(SARS)}$ is junction temperature of the SARS,
 T_C is case temperature of the SARS, and
 θ_{J-C} is thermal resistance between junction to case.

Parameter Setting of Snubber Circuit using SARS

The temperature of the SARS and peripheral components should be measured in actual application operation.

The reference values of snubber circuit using the SARS are as follows:

- **C_S**
680 pF to 0.01 μF.
The voltage rating is selected according to the voltage subtracted the input voltage from the peak of V_{DS}.

- **R_{S1}**
R_{S1} is the bias resistance to turn off the SARS, and is 100 kΩ to 1 MΩ.
Since a high voltage is applied to R_{S1} that has high resistance, the following should be considered according to the requirement of the application:
 - Select a resistor designed for electromigration, or
 - Connect more resistors in series so that the applied voltages of individual resistors can be reduced.The power rating of resistor should be selected from the measurement of the effective current of R_{S1} based on actual operation in the application.

- **R_{S2}**
R_{S2} is the limited resistance in the energy discharging. The value of 22 Ω to 220 Ω is connected to the SARS in series (the SARS10 incorporates R_{S2}).
The power rating of resistor should be selected from the measurement of the effective current of R_{S2} based on actual operation in the application.

Not Recommended for New Designs

SARS01, SARS02, SARS05, SARS10

• Transformer Specifications

Item	Specification
Primary Inductance, L_P	518 μ H
Core Size	EER-28
AL Value	245 nH/ N^2 (with a center gap of about 0.56 mm)
Winding Specification	See Table 1
Winding Structure	See Figure 32

Table 1. Winding Specification

Winding	Symbol	Number of Turns (turns)	Wire Diameter (mm)	Structure
Primary Winding	P1	18	ϕ 0.23 \times 2	Single-layer, solenoid winding
Primary Winding	P2	28	ϕ 0.30	Single-layer, solenoid winding
Auxiliary Winding	D	12	ϕ 0.30 \times 2	Solenoid winding
Output 1 Winding	S1-1	6	ϕ 0.4 \times 2	Solenoid winding
Output 1 Winding	S1-2	6	ϕ 0.4 \times 2	Solenoid winding
Output 2 Winding	S2-1	4	ϕ 0.4 \times 2	Solenoid winding
Output 2 Winding	S2-2	4	ϕ 0.4 \times 2	Solenoid winding

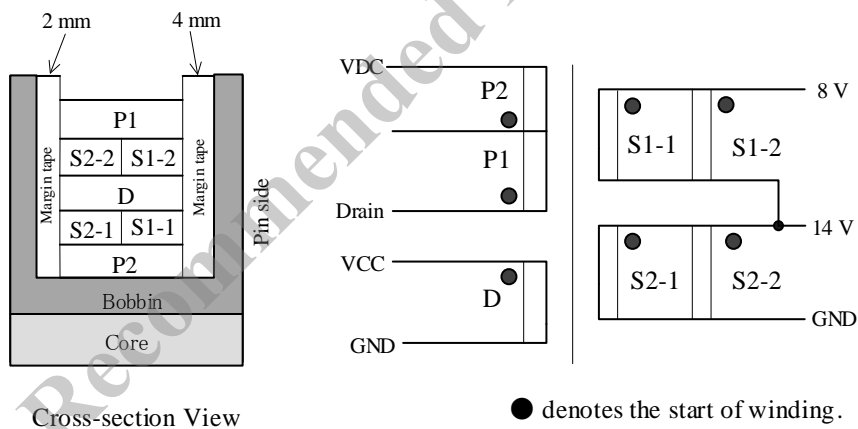

Figure 32. Winding Structure

Important Notes

- All data, illustrations, graphs, tables and any other information included in this document as to Sanken's products listed herein (the "Sanken Products") are current as of the date this document is issued. All contents in this document are subject to any change without notice due to improvement of the Sanken Products, etc. Please make sure to confirm with a Sanken sales representative that the contents set forth in this document reflect the latest revisions before use.
- The Sanken Products are intended for use as components of general purpose electronic equipment or apparatus (such as home appliances, office equipment, telecommunication equipment, measuring equipment, etc.). Prior to use of the Sanken Products, please put your signature, or affix your name and seal, on the specification documents of the Sanken Products and return them to Sanken. When considering use of the Sanken Products for any applications that require higher reliability (such as transportation equipment and its control systems, traffic signal control systems or equipment, disaster/crime alarm systems, various safety devices, etc.), you must contact a Sanken sales representative to discuss the suitability of such use and put your signature, or affix your name and seal, on the specification documents of the Sanken Products and return them to Sanken, prior to the use of the Sanken Products. The Sanken Products are not intended for use in any applications that require extremely high reliability such as: aerospace equipment; nuclear power control systems; and medical equipment or systems, whose failure or malfunction may result in death or serious injury to people, i.e., medical devices in Class III or a higher class as defined by relevant laws of Japan (collectively, the "Specific Applications"). Sanken assumes no liability or responsibility whatsoever for any and all damages and losses that may be suffered by you, users or any third party, resulting from the use of the Sanken Products in the Specific Applications or in manner not in compliance with the instructions set forth herein.
- In the event of using the Sanken Products by either (i) combining other products or materials therewith or (ii) physically, chemically or otherwise processing or treating the same, you must duly consider all possible risks that may result from all such uses in advance and proceed therewith at your own responsibility.
- Although Sanken is making efforts to enhance the quality and reliability of its products, it is impossible to completely avoid the occurrence of any failure or defect in semiconductor products at a certain rate. You must take, at your own responsibility, preventative measures including using a sufficient safety design and confirming safety of any equipment or systems in/for which the Sanken Products are used, upon due consideration of a failure occurrence rate or derating, etc., in order not to cause any human injury or death, fire accident or social harm which may result from any failure or malfunction of the Sanken Products. Please refer to the relevant specification documents and Sanken's official website in relation to derating.
- No anti-radioactive ray design has been adopted for the Sanken Products.
- No contents in this document can be transcribed or copied without Sanken's prior written consent.
- The circuit constant, operation examples, circuit examples, pattern layout examples, design examples, recommended examples, all information and evaluation results based thereon, etc., described in this document are presented for the sole purpose of reference of use of the Sanken Products and Sanken assumes no responsibility whatsoever for any and all damages and losses that may be suffered by you, users or any third party, or any possible infringement of any and all property rights including intellectual property rights and any other rights of you, users or any third party, resulting from the foregoing.
- All technical information described in this document (the "Technical Information") is presented for the sole purpose of reference of use of the Sanken Products and no license, express, implied or otherwise, is granted hereby under any intellectual property rights or any other rights of Sanken.
- Unless otherwise agreed in writing between Sanken and you, Sanken makes no warranty of any kind, whether express or implied, including, without limitation, any warranty (i) as to the quality or performance of the Sanken Products (such as implied warranty of merchantability, or implied warranty of fitness for a particular purpose or special environment), (ii) that any Sanken Product is delivered free of claims of third parties by way of infringement or the like, (iii) that may arise from course of performance, course of dealing or usage of trade, and (iv) as to any information contained in this document (including its accuracy, usefulness, or reliability).
- In the event of using the Sanken Products, you must use the same after carefully examining all applicable environmental laws and regulations that regulate the inclusion or use of any particular controlled substances, including, but not limited to, the EU RoHS Directive, so as to be in strict compliance with such applicable laws and regulations.
- You must not use the Sanken Products or the Technical Information for the purpose of any military applications or use, including but not limited to the development of weapons of mass destruction. In the event of exporting the Sanken Products or the Technical Information, or providing them for non-residents, you must comply with all applicable export control laws and regulations in each country including the U.S. Export Administration Regulations (EAR) and the Foreign Exchange and Foreign Trade Act of Japan, and follow the procedures required by such applicable laws and regulations.
- Sanken assumes no responsibility for any troubles, which may occur during the transportation of the Sanken Products including the falling thereof, out of Sanken's distribution network.
- Although Sanken has prepared this document with its due care to pursue the accuracy thereof, Sanken does not warrant that it is error free and Sanken assumes no liability whatsoever for any and all damages and losses which may be suffered by you resulting from any possible errors or omissions in connection with the contents included herein.
- Please refer to the relevant specification documents in relation to particular precautions when using the Sanken Products, and refer to our official website in relation to general instructions and directions for using the Sanken Products.
- All rights and title in and to any specific trademark or tradename belong to Sanken or such original right holder(s).

DSGN-CEZ-16002